

**ARM[®] Architecture
Reference Manual
ARM[®]v7-A and ARM[®]v7-R edition**

ARM[®]

ARM Architecture Reference Manual

ARMv7-A and ARMv7-R edition

Copyright © 1996-1998, 2000, 2004-2009 ARM Limited. All rights reserved.

Release Information

The following changes have been made to this document.

Change History

Date	Issue	Confidentiality	Change
05 April 2007	A	Non-Confidential	New edition for ARMv7-A and ARMv7-R architecture profiles. Document number changed from ARM DDI 0100 to ARM DDI 0406 and contents restructured.
29 April 2008	B	Non-Confidential	Addition of the VFP Half-precision and Multiprocessing Extensions, and many clarifications and enhancements.
25 November 2008	B	Non-Confidential	PDF with errata issued, errata identified as ARM_2008_Q4.
18 March 2009	B	Non-Confidential	PDF reissued with additional errata. Additional errata identified as ARM_2009_Q1.
July 2009	B	Non-Confidential	PDF reissued with additional errata. Additional errata identified as ARM_2009_Q2.

From ARMv7, the ARM® architecture defines different architectural profiles and this edition of this manual describes only the A and R profiles. For details of the documentation of the ARMv7-M profile see *Further reading* on page xxi. Before ARMv7 there was only a single *ARM Architecture Reference Manual*, with document number DDI 0100. The first issue of this was in February 1996, and the final issue, Issue I, was in July 2005. For more information see *Further reading* on page xxi.

Proprietary Notice

This ARM Architecture Reference Manual is protected by copyright and the practice or implementation of the information herein may be protected by one or more patents or pending applications. No part of this ARM Architecture Reference Manual may be reproduced in any form by any means without the express prior written permission of ARM. **No license, express or implied, by estoppel or otherwise to any intellectual property rights is granted by this ARM Architecture Reference Manual.**

Your access to the information in this ARM Architecture Reference Manual is conditional upon your acceptance that you will not use or permit others to use the information for the purposes of determining whether implementations of the ARM architecture infringe any third party patents.

This ARM Architecture Reference Manual is provided “as is”. ARM makes no representations or warranties, either express or implied, included but not limited to, warranties of merchantability, fitness for a particular purpose, or non-infringement, that the content of this ARM Architecture Reference Manual is suitable for any particular purpose or that any practice or implementation of the contents of the ARM Architecture Reference Manual will not infringe any third party patents, copyrights, trade secrets, or other rights.

This ARM Architecture Reference Manual may include technical inaccuracies or typographical errors.

To the extent not prohibited by law, in no event will ARM be liable for any damages, including without limitation any direct loss, lost revenue, lost profits or data, special, indirect, consequential, incidental or punitive damages, however caused and regardless of the theory of liability, arising out of or related to any furnishing, practicing, modifying or any use of this ARM Architecture Reference Manual, even if ARM has been advised of the possibility of such damages.

Words and logos marked with ® or TM are registered trademarks or trademarks of ARM Limited, except as otherwise stated below in this proprietary notice. Other brands and names mentioned herein may be the trademarks of their respective owners.

Copyright © 1996-1998, 2000, 2004-2009 ARM Limited

110 Fulbourn Road Cambridge, England CB1 9NJ

Restricted Rights Legend: Use, duplication or disclosure by the United States Government is subject to the restrictions set forth in DFARS 252.227-7013 (c)(1)(ii) and FAR 52.227-19.

This document is Non-Confidential but any disclosure by you is subject to you providing notice to and the acceptance by the recipient of, the conditions set out above.

In this document, where the term ARM is used to refer to the company it means “ARM or any of its subsidiaries as appropriate”.

———— **Note** ————

The term ARM is also used to refer to versions of the ARM architecture, for example ARMv6 refers to version 6 of the ARM architecture. The context makes it clear when the term is used in this way.

———— **Note** ————

For the errata PDF, pages ii and iii have been replaced, by an edit to the PDF, to include an updated **Proprietary Notice**. The remainder of the PDF is the original release PDF of issue B of the document, with errata markups.

Contents

ARM Architecture Reference Manual

ARMv7-A and ARMv7-R edition

Preface

About this manual	xiv
Using this manual	xv
Conventions	xviii
Further reading	xx
Feedback	xxi

Part A Application Level Architecture

Chapter A1

Introduction to the ARM Architecture

A1.1	About the ARM architecture	A1-2
A1.2	The ARM and Thumb instruction sets	A1-3
A1.3	Architecture versions, profiles, and variants	A1-4
A1.4	Architecture extensions	A1-6
A1.5	The ARM memory model	A1-7
A1.6	Debug	A1-8

Chapter A2

Application Level Programmers' Model

A2.1	About the Application level programmers' model	A2-2
------	--	------

A2.2	ARM core data types and arithmetic	A2-3
A2.3	ARM core registers	A2-11
A2.4	The Application Program Status Register (APSR)	A2-14
A2.5	Execution state registers	A2-15
A2.6	Advanced SIMD and VFP extensions	A2-20
A2.7	Floating-point data types and arithmetic	A2-32
A2.8	Polynomial arithmetic over {0,1}	A2-67
A2.9	Coprocessor support	A2-68
A2.10	Execution environment support	A2-69
A2.11	Exceptions, debug events and checks	A2-81

Chapter A3 Application Level Memory Model

A3.1	Address space	A3-2
A3.2	Alignment support	A3-4
A3.3	Endian support	A3-7
A3.4	Synchronization and semaphores	A3-12
A3.5	Memory types and attributes and the memory order model	A3-24
A3.6	Access rights	A3-38
A3.7	Virtual and physical addressing	A3-40
A3.8	Memory access order	A3-41
A3.9	Caches and memory hierarchy	A3-51

Chapter A4 The Instruction Sets

A4.1	About the instruction sets	A4-2
A4.2	Unified Assembler Language	A4-4
A4.3	Branch instructions	A4-7
A4.4	Data-processing instructions	A4-8
A4.5	Status register access instructions	A4-18
A4.6	Load/store instructions	A4-19
A4.7	Load/store multiple instructions	A4-22
A4.8	Miscellaneous instructions	A4-23
A4.9	Exception-generating and exception-handling instructions	A4-24
A4.10	Coprocessor instructions	A4-25
A4.11	Advanced SIMD and VFP load/store instructions	A4-26
A4.12	Advanced SIMD and VFP register transfer instructions	A4-29
A4.13	Advanced SIMD data-processing operations	A4-30
A4.14	VFP data-processing instructions	A4-38

Chapter A5 ARM Instruction Set Encoding

A5.1	ARM instruction set encoding	A5-2
A5.2	Data-processing and miscellaneous instructions	A5-4
A5.3	Load/store word and unsigned byte	A5-19
A5.4	Media instructions	A5-21
A5.5	Branch, branch with link, and block data transfer	A5-27
A5.6	Supervisor Call, and coprocessor instructions	A5-28
A5.7	Unconditional instructions	A5-30

Chapter A6	Thumb Instruction Set Encoding	
A6.1	Thumb instruction set encoding	A6-2
A6.2	16-bit Thumb instruction encoding	A6-6
A6.3	32-bit Thumb instruction encoding	A6-14
Chapter A7	Advanced SIMD and VFP Instruction Encoding	
A7.1	Overview	A7-2
A7.2	Advanced SIMD and VFP instruction syntax	A7-3
A7.3	Register encoding	A7-8
A7.4	Advanced SIMD data-processing instructions	A7-10
A7.5	VFP data-processing instructions	A7-24
A7.6	Extension register load/store instructions	A7-26
A7.7	Advanced SIMD element or structure load/store instructions	A7-27
A7.8	8, 16, and 32-bit transfer between ARM core and extension registers	A7-31
A7.9	64-bit transfers between ARM core and extension registers	A7-32
Chapter A8	Instruction Details	
A8.1	Format of instruction descriptions	A8-2
A8.2	Standard assembler syntax fields	A8-7
A8.3	Conditional execution	A8-8
A8.4	Shifts applied to a register	A8-10
A8.5	Memory accesses	A8-13
A8.6	Alphabetical list of instructions	A8-14
Chapter A9	ThumbEE	
A9.1	The ThumbEE instruction set	A9-2
A9.2	ThumbEE instruction set encoding	A9-6
A9.3	Additional instructions in Thumb and ThumbEE instruction sets	A9-7
A9.4	ThumbEE instructions with modified behavior	A9-8
A9.5	Additional ThumbEE instructions	A9-14
Part B	System Level Architecture	
Chapter B1	The System Level Programmers' Model	
B1.1	About the system level programmers' model	B1-2
B1.2	System level concepts and terminology	B1-3
B1.3	ARM processor modes and core registers	B1-6
B1.4	Instruction set states	B1-23
B1.5	The Security Extensions	B1-25
B1.6	Exceptions	B1-30
B1.7	Coprocessors and system control	B1-62
B1.8	Advanced SIMD and floating-point support	B1-64
B1.9	Execution environment support	B1-73

Chapter B2	Common Memory System Architecture Features	
B2.1	About the memory system architecture	B2-2
B2.2	Caches	B2-3
B2.3	Implementation defined memory system features	B2-27
B2.4	Pseudocode details of general memory system operations	B2-29

Chapter B3	Virtual Memory System Architecture (VMSA)	
B3.1	About the VMSA	B3-2
B3.2	Memory access sequence	B3-4
B3.3	Translation tables	B3-7
B3.4	Address mapping restrictions	B3-23
B3.5	Secure and Non-secure address spaces	B3-26
B3.6	Memory access control	B3-28
B3.7	Memory region attributes	B3-32
B3.8	VMSA memory aborts	B3-40
B3.9	Fault Status and Fault Address registers in a VMSA implementation	B3-48
B3.10	Translation Lookaside Buffers (TLBs)	B3-54
B3.11	Virtual Address to Physical Address translation operations	B3-63
B3.12	CP15 registers for a VMSA implementation	B3-64
B3.13	Pseudocode details of VMSA memory system operations	B3-156

Chapter B4	Protected Memory System Architecture (PMSA)	
B4.1	About the PMSA	B4-2
B4.2	Memory access control	B4-9
B4.3	Memory region attributes	B4-11
B4.4	PMSA memory aborts	B4-13
B4.5	Fault Status and Fault Address registers in a PMSA implementation	B4-18
B4.6	CP15 registers for a PMSA implementation	B4-22
B4.7	Pseudocode details of PMSA memory system operations	B4-79

Chapter B5	The CPUID Identification Scheme	
B5.1	Introduction to the CPUID scheme	B5-2
B5.2	The CPUID registers	B5-4
B5.3	Advanced SIMD and VFP feature identification registers	B5-34

Chapter B6	System Instructions	
B6.1	Alphabetical list of instructions	B6-2

Part C Debug Architecture

Chapter C1	Introduction to the ARM Debug Architecture	
C1.1	Scope of part C of this manual	C1-2
C1.2	About the ARM Debug architecture	C1-3

	C1.3	Security Extensions and debug	C1-8
	C1.4	Register interfaces	C1-9
Chapter C2	Invasive Debug Authentication		
	C2.1	About invasive debug authentication	C2-2
Chapter C3	Debug Events		
	C3.1	About debug events	C3-2
	C3.2	Software debug events	C3-5
	C3.3	Halting debug events	C3-38
	C3.4	Generation of debug events	C3-40
	C3.5	Debug event prioritization	C3-43
Chapter C4	Debug Exceptions		
	C4.1	About debug exceptions	C4-2
	C4.2	Effects of debug exceptions on CP15 registers and the DBGWFSR	C4-4
Chapter C5	Debug State		
	C5.1	About Debug state	C5-2
	C5.2	Entering Debug state	C5-3
	C5.3	Behavior of the PC and CPSR in Debug state	C5-7
	C5.4	Executing instructions in Debug state	C5-9
	C5.5	Privilege in Debug state	C5-13
	C5.6	Behavior of non-invasive debug in Debug state	C5-19
	C5.7	Exceptions in Debug state	C5-20
	C5.8	Memory system behavior in Debug state	C5-24
	C5.9	Leaving Debug state	C5-28
Chapter C6	Debug Register Interfaces		
	C6.1	About the debug register interfaces	C6-2
	C6.2	Reset and power-down support	C6-4
	C6.3	Debug register map	C6-18
	C6.4	Synchronization of debug register updates	C6-24
	C6.5	Access permissions	C6-26
	C6.6	The CP14 debug register interfaces	C6-32
	C6.7	The memory-mapped and recommended external debug interfaces	C6-43
Chapter C7	Non-invasive Debug Authentication		
	C7.1	About non-invasive debug authentication	C7-2
	C7.2	v7 Debug non-invasive debug authentication	C7-4
	C7.3	Effects of non-invasive debug authentication	C7-6
	C7.4	ARMv6 non-invasive debug authentication	C7-8

Chapter C8	Sample-based Profiling	
	C8.1 Program Counter sampling	C8-2
Chapter C9	Performance Monitors	
	C9.1 About the performance monitors	C9-2
	C9.2 Status in the ARM architecture	C9-4
	C9.3 Accuracy of the performance monitors	C9-5
	C9.4 Behavior on overflow	C9-6
	C9.5 Interaction with Security Extensions	C9-7
	C9.6 Interaction with trace	C9-8
	C9.7 Interaction with power saving operations	C9-9
	C9.8 CP15 c9 register map	C9-10
	C9.9 Access permissions	C9-12
	C9.10 Event numbers	C9-13
Chapter C10	Debug Registers Reference	
	C10.1 Accessing the debug registers	C10-2
	C10.2 Debug identification registers	C10-3
	C10.3 Control and status registers	C10-10
	C10.4 Instruction and data transfer registers	C10-40
	C10.5 Software debug event registers	C10-48
	C10.6 OS Save and Restore registers, v7 Debug only	C10-75
	C10.7 Memory system control registers	C10-80
	C10.8 Management registers, ARMv7 only	C10-88
	C10.9 Performance monitor registers	C10-105
Appendix A	Recommended External Debug Interface	
	A.1 System integration signals	AppxA-2
	A.2 Recommended debug slave port	AppxA-13
Appendix B	Common VFP Subarchitecture Specification	
	B.1 Scope of this appendix	AppxB-2
	B.2 Introduction to the Common VFP subarchitecture	AppxB-3
	B.3 Exception processing	AppxB-6
	B.4 Support code requirements	AppxB-11
	B.5 Context switching	AppxB-14
	B.6 Subarchitecture additions to the VFP system registers	AppxB-15
	B.7 Version 1 of the Common VFP subarchitecture	AppxB-23
	B.8 Version 2 of the Common VFP subarchitecture	AppxB-24
Appendix C	Legacy Instruction Mnemonics	
	C.1 Thumb instruction mnemonics	AppxC-2
	C.2 Pre-UAL pseudo-instruction NOP	AppxC-3

Appendix D	Deprecated and Obsolete Features	
D.1	Deprecated features	AppxD-2
D.2	Deprecated terminology	AppxD-5
D.3	Obsolete features	AppxD-6
D.4	Semaphore instructions	AppxD-7
D.5	Use of the SP as a general-purpose register	AppxD-8
D.6	Explicit use of the PC in ARM instructions	AppxD-9
D.7	Deprecated Thumb instructions	AppxD-10
Appendix E	Fast Context Switch Extension (FCSE)	
E.1	About the FCSE	AppxE-2
E.2	Modified virtual addresses	AppxE-3
E.3	Debug and trace	AppxE-5
Appendix F	VFP Vector Operation Support	
F.1	About VFP vector mode	AppxF-2
F.2	Vector length and stride control	AppxF-3
F.3	VFP register banks	AppxF-5
F.4	VFP instruction type selection	AppxF-7
Appendix G	ARMv6 Differences	
G.1	Introduction to ARMv6	AppxG-2
G.2	Application level register support	AppxG-3
G.3	Application level memory support	AppxG-6
G.4	Instruction set support	AppxG-10
G.5	System level register support	AppxG-16
G.6	System level memory model	AppxG-20
G.7	System Control coprocessor (CP15) support	AppxG-29
Appendix H	ARMv4 and ARMv5 Differences	
H.1	Introduction to ARMv4 and ARMv5	AppxH-2
H.2	Application level register support	AppxH-4
H.3	Application level memory support	AppxH-6
H.4	Instruction set support	AppxH-11
H.5	System level register support	AppxH-18
H.6	System level memory model	AppxH-21
H.7	System Control coprocessor (CP15) support	AppxH-31
Appendix I	Pseudocode Definition	
I.1	Instruction encoding diagrams and pseudocode	AppxI-2
I.2	Limitations of pseudocode	AppxI-4
I.3	Data types	AppxI-5
I.4	Expressions	AppxI-9
I.5	Operators and built-in functions	AppxI-11
I.6	Statements and program structure	AppxI-17
I.7	Miscellaneous helper procedures and functions	AppxI-22

Appendix J	Pseudocode Index	
	J.1 Pseudocode operators and keywords	AppxJ-2
	J.2 Pseudocode functions and procedures	AppxJ-6
Appendix K	Register Index	
	K.1 Register index	AppxK-2
	Glossary	

Preface

This preface summarizes the contents of this manual and lists the conventions it uses. It contains the following sections:

- *About this manual* on page xiv
- *Using this manual* on page xv
- *Conventions* on page xviii
- *Further reading* on page xx
- *Feedback* on page xxi.

About this manual

This manual describes the ARM[®]v7 instruction set architecture, including its high code density Thumb[®] instruction encoding and the following extensions to it:

- The System Control coprocessor, coprocessor 15 (CP15), used to control memory system components such as caches, write buffers, Memory Management Units, and Protection Units.
- The optional Advanced SIMD extension, that provides high-performance integer and single-precision floating-point vector operations.
- The optional VFP extension, that provides high-performance floating-point operations. It can optionally support double-precision operations.
- The Debug architecture, that provides software access to debug features in ARM processors.

Part A describes the application level view of the architecture. It describes the application level view of the programmers' model and the memory model. It also describes the precise effects of each instruction in *User mode* (the normal operating mode), including any restrictions on its use. This information is of primary importance to authors and users of compilers, assemblers, and other programs that generate ARM machine code.

Part B describes the system level view of the architecture. It gives details of system registers that are not accessible from User mode, and the system level view of the memory model. It also gives full details of the effects of instructions in *privileged modes* (any mode other than User mode), where these are different from their effects in User mode.

Part C describes the Debug architecture. This is an extension to the ARM architecture that provides configuration, breakpoint and watchpoint support, and a *Debug Communications Channel* (DCC) to a debug host.

Assembler syntax is given for the instructions described in this manual, permitting instructions to be specified in textual form. However, this manual is not intended as tutorial material for ARM assembler language, nor does it describe ARM assembler language at anything other than a very basic level. To make effective use of ARM assembler language, consult the documentation supplied with the assembler being used.

Using this manual

The information in this manual is organized into four parts, as described below.

Part A, Application Level Architecture

Part A describes the application level view of the architecture. It contains the following chapters:

- Chapter A1** Gives a brief overview of the ARM architecture, and the ARM and Thumb instruction sets.
- Chapter A2** Describes the application level view of the ARM programmers' model, including the application level view of the Advanced SIMD and VFP extensions. It describes the types of value that ARM instructions operate on, the general-purpose registers that contain those values, and the Application Program Status Register.
- Chapter A3** Describes the application level view of the memory model, including the ARM memory types and attributes, and memory access control.
- Chapter A4** Describes the range of instructions available in the ARM, Thumb, Advanced SIMD, and VFP instruction sets. It also contains some details of instruction operation, where these are common to several instructions.
- Chapter A5** Gives details of the encoding of the ARM instruction set.
- Chapter A6** Gives details of the encoding of the Thumb instruction set.
- Chapter A7** Gives details of the encoding of the Advanced SIMD and VFP instruction sets.
- Chapter A8** Provides detailed reference information about every instruction available in the Thumb, ARM, Advanced SIMD, and VFP instruction sets, with the exception of information only relevant in privileged modes.
- Chapter A9** Provides detailed reference information about the ThumbEE (Execution Environment) variant of the Thumb instruction set.

Part B, System Level Architecture

Part B describes the system level view of the architecture. It contains the following chapters:

- Chapter B1** Describes the system level view of the programmers' model.
- Chapter B2** Describes the system level view of the memory model features that are common to all memory systems.
- Chapter B3** Describes the system level view of the Virtual Memory System Architecture (VMSA) that is part of all ARMv7-A implementations. This chapter includes descriptions of all of the CP15 System Control Coprocessor registers in a VMSA implementation.
- Chapter B4** Describes the system level view of the Protected Memory System Architecture (PMSA) that is part of all ARMv7-R implementations. This chapter includes descriptions of all of the CP15 System Control Coprocessor registers in a PMSA implementation.
- Chapter B5** Describes the CPUID scheme.
- Chapter B6** Provides detailed reference information about system instructions, and more information about instructions where they behave differently in privileged modes.

Part C, Debug Architecture

Part C describes the Debug architecture. It contains the following chapters:

- Chapter C1** Gives a brief introduction to the Debug architecture.
- Chapter C2** Describes the authentication of invasive debug.
- Chapter C3** Describes the debug events.
- Chapter C4** Describes the debug exceptions.
- Chapter C5** Describes Debug state.
- Chapter C6** Describes the permitted debug register interfaces.
- Chapter C7** Describes the authentication of non-invasive debug.
- Chapter C8** Describes sample-based profiling.
- Chapter C9** Describes the ARM performance monitors.
- Chapter C10** Describes the debug registers.

Part D, Appendices

This manual contains the following appendices:

Appendix A Describes the recommended external Debug interfaces.

———— **Note** —————

This description is not part of the ARM architecture specification. It is included here only as supplementary information, for the convenience of developers and users who might require this information.

Appendix B The Common VFP subarchitecture specification.

———— **Note** —————

This specification is not part of the ARM architecture specification. This sub-architectural information is included here only as supplementary information, for the convenience of developers and users who might require this information.

Appendix C Describes the legacy mnemonics.

Appendix D Identifies the deprecated architectural features.

Appendix E Describes the *Fast Context Switch Extension* (FCSE). From ARMv6, the use of this feature is deprecated, and in ARMv7 the FCSE is optional.

Appendix F Describes the VFP vector operations. Use of these operations is deprecated in ARMv7.

Appendix G Describes the differences in the ARMv6 architecture.

Appendix H Describes the differences in the ARMv4 and ARMv5 architectures.

Appendix I The formal definition of the pseudocode.

Appendix J Index to definitions of pseudocode operators, keywords, functions, and procedures.

Appendix K Index to register descriptions in the manual.

Conventions

This manual employs typographic and other conventions intended to improve its ease of use.

General typographic conventions

<code>typewriter</code>	Is used for assembler syntax descriptions, pseudocode descriptions of instructions, and source code examples. In the cases of assembler syntax descriptions and pseudocode descriptions, see the additional conventions below. The typewriter style is also used in the main text for instruction mnemonics and for references to other items appearing in assembler syntax descriptions, pseudocode descriptions of instructions and source code examples.
<i>italic</i>	Highlights important notes, introduces special terminology, and denotes internal cross-references and citations.
bold	Is used for emphasis in descriptive lists and elsewhere, where appropriate.
SMALL CAPITALS	Are used for a few terms that have specific technical meanings. Their meanings can be found in the <i>Glossary</i> .

Signals

In general this specification does not define processor signals, but it does include some signal examples and recommendations. It uses the following signal conventions:

Signal level	The level of an asserted signal depends on whether the signal is active-HIGH or active-LOW. Asserted means: <ul style="list-style-type: none">• HIGH for active-HIGH signals• LOW for active-LOW signals.
Lower-case n	At the start or end of a signal name denotes an active-LOW signal.

Numbers

Numbers are normally written in decimal. Binary numbers are preceded by 0b, and hexadecimal numbers by 0x and written in a typewriter font.

Bit values

Values of bits and bitfields are normally given in binary, in single quotes. The quotes are normally omitted in encoding diagrams and tables.

Pseudocode descriptions

This manual uses a form of pseudocode to provide precise descriptions of the specified functionality. This pseudocode is written in a typewriter font, and is described in Appendix I *Pseudocode Definition*.

Assembler syntax descriptions

This manual contains numerous syntax descriptions for assembler instructions and for components of assembler instructions. These are shown in a typewriter font, and use the conventions described in *Assembler syntax* on page A8-4.

Further reading

This section lists publications from both ARM and third parties that provide more information on the ARM family of processors.

ARM periodically provides updates and corrections to its documentation. See <http://www.arm.com> for current errata sheets and addenda, and the ARM Frequently Asked Questions.

ARM publications

- *ARM Debug Interface v5 Architecture Specification* (ARM IHI 0031)
- *ARMv7-M Architecture Reference Manual* (ARM DDI 0403)
- *CoreSight Architecture Specification* (ARM IHI 0029)
- *ARM Architecture Reference Manual* (ARM DDI 0100I)

———— Note —————

- Issue I of the *ARM Architecture Reference Manual* (DDI 0100I) was issued in July 2005 and describes the first version of the ARMv6 architecture, and all previous architecture versions.
- Addison-Wesley Professional publish *ARM Architecture Reference Manual, Second Edition* (December 27, 2000). The contents of this are identical to Issue E of the *ARM Architecture Reference Manual* (DDI 0100E). It describes ARMv5TE and earlier versions of the ARM architecture, and is superseded by DDI 0100I.

- *Embedded Trace Macrocell Architecture Specification* (ARM IHI 0014)
- *CoreSight Program Flow Trace Architecture Specification* (ARM IHI 0035).

External publications

The following books are referred to in this manual, or provide more information:

- IEEE Std 1596.5-1993, *IEEE Standard for Shared-Data Formats Optimized for Scalable Coherent Interface (SCI) Processors*, ISBN 1-55937-354-7
- IEEE Std 1149.1-2001, *IEEE Standard Test Access Port and Boundary Scan Architecture (JTAG)*
- ANSI/IEEE Std 754-1985, *IEEE Standard for Binary Floating-Point Arithmetic*
- JEP106, *Standard Manufacturers Identification Code*, JEDEC Solid State Technology Association
- *The Java Virtual Machine Specification* Second Edition, Tim Lindholm and Frank Yellin, published by Addison Wesley (ISBN: 0-201-43294-3)
- *Memory Consistency Models for Shared Memory-Multiprocessors*, Kourosh Gharachorloo, Stanford University Technical Report CSL-TR-95-685

Feedback

ARM welcomes feedback on its documentation.

Feedback on this manual

If you notice any errors or omissions in this manual, send e-mail to errata@arm.com giving:

- the document title
- the document number
- the page number(s) to which your comments apply
- a concise explanation of the problem.

General suggestions for additions and improvements are also welcome.

Part A

Application Level Architecture

Chapter A1

Introduction to the ARM Architecture

This chapter introduces the ARM architecture and contains the following sections:

- *About the ARM architecture* on page A1-2
- *The ARM and Thumb instruction sets* on page A1-3
- *Architecture versions, profiles, and variants* on page A1-4
- *Architecture extensions* on page A1-6
- *The ARM memory model* on page A1-7
- *Debug* on page A1-8.

A1.1 About the ARM architecture

The ARM architecture supports implementations across a wide range of performance points. It is established as the dominant architecture in many market segments. The architectural simplicity of ARM processors leads to very small implementations, and small implementations mean devices can have very low power consumption. Implementation size, performance, and very low power consumption are key attributes of the ARM architecture.

The ARM architecture is a *Reduced Instruction Set Computer* (RISC) architecture, as it incorporates these typical RISC architecture features:

- a large uniform register file
- a *load/store* architecture, where data-processing operations only operate on register contents, not directly on memory contents
- simple addressing modes, with all load/store addresses being determined from register contents and instruction fields only.

In addition, the ARM architecture provides:

- instructions that combine a shift with an arithmetic or logical operation
- auto-increment and auto-decrement addressing modes to optimize program loops
- Load and Store Multiple instructions to maximize data throughput
- conditional execution of almost all instructions to maximize execution throughput.

These enhancements to a basic RISC architecture enable ARM processors to achieve a good balance of high performance, small code size, low power consumption, and small silicon area.

Except where the architecture specifies differently, the programmer-visible behavior of an implementation must be the same as a simple sequential execution of the program. This programmer-visible behavior does not include the execution time of the program.

A1.2 The ARM and Thumb instruction sets

The ARM instruction set is a set of 32-bit instructions providing comprehensive data-processing and control functions.

The Thumb instruction set was developed as a 16-bit instruction set with a subset of the functionality of the ARM instruction set. It provides significantly improved code density, at a cost of some reduction in performance. A processor executing Thumb instructions can change to executing ARM instructions for performance critical segments, in particular for handling interrupts.

In ARMv6T2, Thumb-2 technology is introduced. This technology makes it possible to extend the original Thumb instruction set with many 32-bit instructions. The range of 32-bit Thumb instructions included in ARMv6T2 permits Thumb code to achieve performance similar to ARM code, with code density better than that of earlier Thumb code.

From ARMv6T2, the ARM and Thumb instruction sets provide almost identical functionality. For more information, see Chapter A4 *The Instruction Sets*.

A1.3 Architecture versions, profiles, and variants

The ARM and Thumb instruction set architectures have evolved significantly since they were first developed. They will continue to be developed in the future. Seven major versions of the instruction set have been defined to date, denoted by the version numbers 1 to 7. Of these, the first three versions are now obsolete.

ARMv7 provides three profiles:

- ARMv7-A** Application profile, described in this manual. Implements a traditional ARM architecture with multiple modes and supporting a *Virtual Memory System Architecture* (VMSA) based on an MMU. Supports the ARM and Thumb instruction sets.
- ARMv7-R** Real-time profile, described in this manual. Implements a traditional ARM architecture with multiple modes and supporting a *Protected Memory System Architecture* (PMSA) based on an MPU. Supports the ARM and Thumb instruction sets.
- ARMv7-M** Microcontroller profile, described in the ARMv7-M Architecture Reference Manual. Implements a programmers' model designed for fast interrupt processing, with hardware stacking of registers and support for writing interrupt handlers in high-level languages. Implements a variant of the ARMv7 PMSA and supports a variant of the Thumb instruction set.

Versions can be qualified with variant letters to specify additional instructions and other functionality that are included as an architecture extension. Extensions are typically included in the base architecture of the next version number. Provision is also made to exclude variants by prefixing the variant letter with x.

Some extensions are described separately instead of using a variant letter. For details of these extensions see *Architecture extensions* on page A1-6.

The valid variants of ARMv4, ARMv5, and ARMv6 are as follows:

- ARMv4** The earliest architecture variant covered by this manual. It includes only the ARM instruction set.
- ARMv4T** Adds the Thumb instruction set.
- ARMv5T** Improves interworking of ARM and Thumb instructions. Adds count leading zeros (CLZ) and software breakpoint (BKPT) instructions.
- ARMv5TE** Enhances arithmetic support for digital signal processing (DSP) algorithms. Adds preload data (PLD), dual word load (LDRD), store (STRD), and 64-bit coprocessor register transfers (MCRR, MRRC).
- ARMv5TEJ** Adds the BXJ instruction and other support for the Jazelle® architecture extension.
- ARMv6** Adds many new instructions to the ARM instruction set. Formalizes and revises the memory model and the Debug architecture.
- ARMv6K** Adds instructions to support multi-processing to the ARM instruction set, and some extra memory model features.

ARMv6T2 Introduces Thumb-2 technology, giving a major development of the Thumb instruction set to provide a similar level of functionality to the ARM instruction set.

———— **Note** —————

ARMv6KZ or ARMv6Z are sometimes used to describe the ARMv6K architecture with the optional Security Extensions.

For detailed information about versions of the ARM architecture, see Appendix G *ARMv6 Differences* and Appendix H *ARMv4 and ARMv5 Differences*.

The following architecture variants are now obsolete:

ARMv1, ARMv2, ARMv2a, ARMv3, ARMv3G, ARMv3M, ARMv4xM, ARMv4TxM, ARMv5, ARMv5xM, ARMv5TxM, and ARMv5TEp.

Contact ARM if you require details of obsolete variants.

Instruction descriptions in this manual specify the architecture versions that support them.

A1.4 Architecture extensions

This manual describes the following extensions to the ARM and Thumb instruction set architectures:

- ThumbEE** Is a variant of the Thumb instruction set that is designed as a target for dynamically generated code. It is:
- a required extension to the ARMv7-A profile
 - an optional extension to the ARMv7-R profile.
- VFP** Is a floating-point coprocessor extension to the instruction set architectures. There have been three main versions of VFP to date:
- VFPv1 is obsolete. Details are available on request from ARM.
 - VFPv2 is an optional extension to:
 - the ARM instruction set in the ARMv5TE, ARMv5TEJ, ARMv6, and ARMv6K architectures
 - the ARM and Thumb instruction sets in the ARMv6T2 architecture.
 - VFPv3 is an optional extension to the ARM, Thumb and ThumbEE instruction sets in the ARMv7-A and ARMv7-R profiles.
VFPv3 can be implemented with either thirty-two or sixteen doubleword registers, as described in *Advanced SIMD and VFP extension registers* on page A2-21. Where necessary, the terms VFPv3-D32 and VFPv3-D16 are used to distinguish between these two implementation options. Where the term VFPv3 is used it covers both options.
VFPv3 can be extended by the half-precision extensions that provide conversion functions in both directions between half-precision floating-point and single-precision floating-point.
- Advanced SIMD** Is an instruction set extension that provides *Single Instruction Multiple Data* (SIMD) functionality. It is an optional extension to the ARMv7-A and ARMv7-R profiles. When VFPv3 and Advanced SIMD are both implemented, they use a shared register bank and have some shared instructions.
Advanced SIMD can be extended by the half-precision extensions that provide conversion functions in both directions between half-precision floating-point and single-precision floating-point.
- Security Extensions** Are a set of security features that facilitate the development of secure applications. They are an optional extension to the ARMv6K architecture and the ARMv7-A profile.
- Jazelle** Is the Java bytecode execution extension that extended ARMv5TE to ARMv5TEJ. From ARMv6 Jazelle is a required part of the architecture, but is still often described as the Jazelle extension.

Multiprocessing Extensions

Are a set of features that enhance multiprocessing functionality. They are an optional extension to the ARMv7-A and ARMv7-R profiles.

A1.5 The ARM memory model

The ARM architecture uses a single, flat address space of 2^{32} 8-bit bytes. The address space is also regarded as 2^{30} 32-bit words or 2^{31} 16-bit halfwords.

The architecture provides facilities for:

- faulting unaligned memory accesses
- restricting access by applications to specified areas of memory
- translating virtual addresses provided by executing instructions into physical addresses
- altering the interpretation of word and halfword data between big-endian and little-endian
- optionally preventing out-of-order access to memory
- controlling caches
- synchronizing access to shared memory by multiple processors.

For more information, see:

- Chapter A3 *Application Level Memory Model*
- Chapter B2 *Common Memory System Architecture Features*
- Chapter B3 *Virtual Memory System Architecture (VMSA)*
- Chapter B4 *Protected Memory System Architecture (PMSA)*.

A1.6 Debug

ARMv7 processors implement two types of debug support:

Invasive debug Debug permitting modification of the state of the processor. This is intended primarily for run-control debugging.

Non-invasive debug Debug permitting data and program flow observation, without modifying the state of the processor or interrupting the flow of execution.

This provides for:

- instruction and data tracing
- program counter sampling
- performance monitors.

For more information, see Chapter C1 *Introduction to the ARM Debug Architecture*.

Chapter A2

Application Level Programmers' Model

This chapter gives an application level view of the ARM programmers' model. It contains the following sections:

- *About the Application level programmers' model* on page A2-2
- *ARM core data types and arithmetic* on page A2-3
- *ARM core registers* on page A2-11
- *The Application Program Status Register (APSR)* on page A2-14
- *Execution state registers* on page A2-15
- *Advanced SIMD and VFP extensions* on page A2-20
- *Floating-point data types and arithmetic* on page A2-32
- *Polynomial arithmetic over $\{0,1\}$* on page A2-67
- *Coprocessor support* on page A2-68
- *Execution environment support* on page A2-69
- *Exceptions, debug events and checks* on page A2-81.

A2.1 About the Application level programmers' model

This chapter contains the programmers' model information required for application development.

The information in this chapter is distinct from the system information required to service and support application execution under an operating system. However, some knowledge of that system information is needed to put the Application level programmers' model into context.

System level support requires access to all features and facilities of the architecture, a mode of operation referred to as privileged operation. System code determines whether an application runs in a privileged or unprivileged manner. When an operating system supports both privileged and unprivileged operation, an application usually runs unprivileged. This:

- permits the operating system to allocate system resources to it in a unique or shared manner
- provides a degree of protection from other processes and tasks, and so helps protect the operating system from malfunctioning applications.

This chapter indicates where some system level understanding is helpful, and where appropriate it:

- gives an overview of the system level information
- gives references to the system level descriptions in Chapter B1 *The System Level Programmers' Model* and elsewhere.

The Security Extensions extend the architecture to provide hardware security features that support the development of secure applications. For more information, see *The Security Extensions* on page B1-25.

A2.2 ARM core data types and arithmetic

All ARMv7-A and ARMv7-R processors support the following data types in memory:

Byte	8 bits
Halfword	16 bits
Word	32 bits
Doubleword	64 bits.

Processor registers are 32 bits in size. The instruction set contains instructions supporting the following data types held in registers:

- 32-bit pointers
- unsigned or signed 32-bit integers
- unsigned 16-bit or 8-bit integers, held in zero-extended form
- signed 16-bit or 8-bit integers, held in sign-extended form
- two 16-bit integers packed into a register
- four 8-bit integers packed into a register
- unsigned or signed 64-bit integers held in two registers.

Load and store operations can transfer bytes, halfwords, or words to and from memory. Loads of bytes or halfwords zero-extend or sign-extend the data as it is loaded, as specified in the appropriate load instruction.

The instruction sets include load and store operations that transfer two or more words to and from memory. You can load and store doublewords using these instructions. The exclusive doubleword load/store instructions LDREXD and STREXD specify single-copy atomic doubleword accesses to memory.

When any of the data types is described as *unsigned*, the N-bit data value represents a non-negative integer in the range 0 to 2^N-1 , using normal binary format.

When any of these types is described as *signed*, the N-bit data value represents an integer in the range -2^{N-1} to $+2^{N-1}-1$, using two's complement format.

The instructions that operate on packed halfwords or bytes include some multiply instructions that use just one of two halfwords, and *Single Instruction Multiple Data* (SIMD) instructions that operate on all of the halfwords or bytes in parallel.

Direct instruction support for 64-bit integers is limited, and most 64-bit operations require sequences of two or more instructions to synthesize them.

A2.2.1 Integer arithmetic

The instruction set provides a wide variety of operations on the values in registers, including bitwise logical operations, shifts, additions, subtractions, multiplications, and many others. These operations are defined using the *pseudocode* described in Appendix I *Pseudocode Definition*, usually in one of three ways:

- By direct use of the pseudocode operators and built-in functions defined in *Operators and built-in functions* on page AppxI-11.
- By use of pseudocode helper functions defined in the main text. These can be located using the table in Appendix J *Pseudocode Index*.
- By a sequence of the form:
 1. Use of the `SInt()`, `UInt()`, and `Int()` built-in functions defined in *Converting bitstrings to integers* on page AppxI-14 to convert the bitstring contents of the instruction operands to the unbounded integers that they represent as two's complement or unsigned integers.
 2. Use of mathematical operators, built-in functions and helper functions on those unbounded integers to calculate other such integers.
 3. Use of either the bitstring extraction operator defined in *Bitstring extraction* on page AppxI-12 or of the saturation helper functions described in *Pseudocode details of saturation* on page A2-9 to convert an unbounded integer result into a bitstring result that can be written to a register.

Shift and rotate operations

The following types of shift and rotate operations are used in instructions:

Logical Shift Left

(LSL) moves each bit of a bitstring left by a specified number of bits. Zeros are shifted in at the right end of the bitstring. Bits that are shifted off the left end of the bitstring are discarded, except that the last such bit can be produced as a carry output.

Logical Shift Right

(LSR) moves each bit of a bitstring right by a specified number of bits. Zeros are shifted in at the left end of the bitstring. Bits that are shifted off the right end of the bitstring are discarded, except that the last such bit can be produced as a carry output.

Arithmetic Shift Right

(ASR) moves each bit of a bitstring right by a specified number of bits. Copies of the leftmost bit are shifted in at the left end of the bitstring. Bits that are shifted off the right end of the bitstring are discarded, except that the last such bit can be produced as a carry output.

Rotate Right (ROR) moves each bit of a bitstring right by a specified number of bits. Each bit that is shifted off the right end of the bitstring is re-introduced at the left end. The last bit shifted off the right end of the bitstring can be produced as a carry output.

Rotate Right with Extend

(RRX) moves each bit of a bitstring right by one bit. The carry input is shifted in at the left end of the bitstring. The bit shifted off the right end of the bitstring can be produced as a carry output.

Pseudocode details of shift and rotate operations

These shift and rotate operations are supported in pseudocode by the following functions:

```
// LSL_C()
// =====

(bits(N), bit) LSL_C(bits(N) x, integer shift)
    assert shift > 0;
    extended_x = x : Zeros(shift);
    result = extended_x<N-1:0>;
    carry_out = extended_x<N>;
    return (result, carry_out);

// LSL()
// =====

bits(N) LSL(bits(N) x, integer shift)
    assert shift >= 0;
    if shift == 0 then
        result = x;
    else
```

```

        (result, -) = LSL_C(x, shift);
    return result;

// LSR_C()
// =====

(bits(N), bit) LSR_C(bits(N) x, integer shift)
    assert shift > 0;
    extended_x = ZeroExtend(x, shift+N);
    result = extended_x<shift+N-1:shift>;
    carry_out = extended_x<shift-1>;
    return (result, carry_out);

// LSR()
// =====

bits(N) LSR(bits(N) x, integer shift)
    assert shift >= 0;
    if shift == 0 then
        result = x;
    else
        (result, -) = LSR_C(x, shift);
    return result;

// ASR_C()
// =====

(bits(N), bit) ASR_C(bits(N) x, integer shift)
    assert shift > 0;
    extended_x = SignExtend(x, shift+N);
    result = extended_x<shift+N-1:shift>;
    carry_out = extended_x<shift-1>;
    return (result, carry_out);

// ASR()
// =====

bits(N) ASR(bits(N) x, integer shift)
    assert shift >= 0;
    if shift == 0 then
        result = x;
    else
        (result, -) = ASR_C(x, shift);
    return result;

// ROR_C()
// =====

(bits(N), bit) ROR_C(bits(N) x, integer shift)
    assert shift != 0;
    m = shift MOD N;
    result = LSR(x,m) OR LSL(x,N-m);
    carry_out = result<N-1>;
    return (result, carry_out);

```

```
// ROR()
// =====

bits(N) ROR(bits(N) x, integer shift)
    if n == 0 then
        result = x;
    else
        (result, -) = ROR_C(x, shift);
    return result;

// RRX_C()
// =====

(bits(N), bit) RRX_C(bits(N) x, bit carry_in)
    result = carry_in : x<N-1:1>;
    carry_out = x<0>;
    return (result, carry_out);

// RRX()
// =====

bits(N) RRX(bits(N) x, bit carry_in)
    (result, -) = RRX_C(x, shift);
    return result;
```

Pseudocode details of addition and subtraction

In pseudocode, addition and subtraction can be performed on any combination of unbounded integers and bitstrings, provided that if they are performed on two bitstrings, the bitstrings must be identical in length. The result is another unbounded integer if both operands are unbounded integers, and a bitstring of the same length as the bitstring operand(s) otherwise. For the precise definition of these operations, see *Addition and subtraction* on page AppXI-15.

The main addition and subtraction instructions can produce status information about both unsigned carry and signed overflow conditions. This status information can be used to synthesize multi-word additions and subtractions. In pseudocode the `AddWithCarry()` function provides an addition with a carry input and carry and overflow outputs:

```
// AddWithCarry()
// =====

(bits(N), bit, bit) AddWithCarry(bits(N) x, bits(N) y, bit carry_in)
  unsigned_sum = UInt(x) + UInt(y) + UInt(carry_in);
  signed_sum   = SInt(x) + SInt(y) + UInt(carry_in);
  result       = unsigned_sum<N-1:0>; // == signed_sum<N-1:0>
  carry_out    = if UInt(result) == unsigned_sum then '0' else '1';
  overflow     = if SInt(result) == signed_sum then '0' else '1';
  return (result, carry_out, overflow);
```

An important property of the `AddWithCarry()` function is that if:

```
(result, carry_out, overflow) = AddWithCarry(x, NOT(y), carry_in)
```

then:

- if `carry_in == '1'`, then `result == x-y` with:
 - `overflow == '1'` if signed overflow occurred during the subtraction
 - `carry_out == '1'` if unsigned borrow did not occur during the subtraction, that is, if $x \geq y$
- if `carry_in == '0'`, then `result == x-y-1` with:
 - `overflow == '1'` if signed overflow occurred during the subtraction
 - `carry_out == '1'` if unsigned borrow did not occur during the subtraction, that is, if $x > y$.

Together, these mean that the `carry_in` and `carry_out` bits in `AddWithCarry()` calls can act as *NOT borrow* flags for subtractions as well as *carry* flags for additions.

Pseudocode details of saturation

Some instructions perform *saturating arithmetic*, that is, if the result of the arithmetic overflows the destination signed or unsigned N-bit integer range, the result produced is the largest or smallest value in that range, rather than wrapping around modulo 2^N . This is supported in pseudocode by the SignedSatQ() and UnsignedSatQ() functions when a boolean result is wanted saying whether saturation occurred, and by the SignedSat() and UnsignedSat() functions when only the saturated result is wanted:

```
// SignedSatQ()
// =====

(bits(N), boolean) SignedSatQ(integer i, integer N)
  if i > 2^(N-1) - 1 then
    result = 2^(N-1) - 1; saturated = TRUE;
  elseif i < -(2^(N-1)) then
    result = -(2^(N-1)); saturated = TRUE;
  else
    result = i; saturated = FALSE;
  return (result<N-1:0>, saturated);

// UnsignedSatQ()
// =====

(bits(N), boolean) UnsignedSatQ(integer i, integer N)
  if i > 2^N - 1 then
    result = 2^N - 1; saturated = TRUE;
  elseif i < 0 then
    result = 0; saturated = TRUE;
  else
    result = i; saturated = FALSE;
  return (result<N-1:0>, saturated);

// SignedSat()
// =====

bits(N) SignedSat(integer i, integer N)
  (result, -) = SignedSatQ(i, N);
  return result;

// UnsignedSat()
// =====

bits(N) UnsignedSat(integer i, integer N)
  (result, -) = UnsignedSatQ(i, N);
  return result;
```

SatQ(i, N, unsigned) returns either UnsignedSatQ(i, N) or SignedSatQ(i, N) depending on the value of its third argument, and Sat(i, N, unsigned) returns either UnsignedSat(i, N) or SignedSat(i, N) depending on the value of its third argument:

```
// SatQ()
// =====

(bits(N), boolean) SatQ(integer i, integer N, boolean unsigned)
    (result, sat) = if unsigned then UnsignedSatQ(i, N) else SignedSatQ(i, N);
    return (result, sat);

// Sat()
// =====

bits(N) Sat(integer i, integer N, boolean unsigned)
    result = if unsigned then UnsignedSat(i, N) else SignedSat(i, N);
    return result;
```

A2.3 ARM core registers

In the application level view, an ARM processor has:

- thirteen general-purpose 32-bit registers, R0 to R12
- three 32-bit registers, R13 to R15, that sometimes or always have a special use.

Registers R13 to R15 are usually referred to by names that indicate their special uses:

SP, the Stack Pointer

Register R13 is used as a pointer to the active stack.

In Thumb code, most instructions cannot access SP. The only instructions that can access SP are those designed to use SP as a stack pointer.

The use of SP for any purpose other than as a stack pointer is deprecated.

————— Note —————

Using SP for any purpose other than as a stack pointer is likely to break the requirements of operating systems, debuggers, and other software systems, causing them to malfunction.

LR, the Link Register

Register R14 is used to store the return address from a subroutine. At other times, LR can be used for other purposes.

When a BL or BLX instruction performs a subroutine call, LR is set to the subroutine return address. To perform a subroutine return, copy LR back to the program counter. This is typically done in one of two ways, after entering the subroutine with a BL or BLX instruction:

- Return with a BX LR instruction.
- On subroutine entry, store LR to the stack with an instruction of the form:
`PUSH {<registers>,LR}`
 and use a matching instruction to return:
`POP {<registers>,PC}`

ThumbEE checks and handler calls use LR in a similar way. For details see Chapter A9 *ThumbEE*.

PC, the Program Counter

Register R15 is the program counter:

- When executing an ARM instruction, PC reads as the address of the current instruction plus 8.
- When executing a Thumb instruction, PC reads as the address of the current instruction plus 4.
- Writing an address to PC causes a branch to that address.

In Thumb code, most instructions cannot access PC.

See *ARM core registers* on page B1-9 for the system level view of SP, LR, and PC.

Note

The names SP, LR and PC are preferred to R13, R14 and R15. However, sometimes it is simpler to use the R13-R15 names when referring to a group of registers. For example, it is simpler to refer to *Registers R8 to R15*, rather than to *Registers R8 to R12, the SP, LR and PC*. However these two descriptions of the group of registers have exactly the same meaning.

A2.3.1 Pseudocode details of operations on ARM core registers

In pseudocode, the R[] function is used to:

- Read or write R0-R12, SP, and LR, using n == 0-12, 13, and 14 respectively.
- Read the PC, using n == 15.

This function has prototypes:

```
bits(32) R[integer n]
    assert n >= 0 && n <= 15;
```

```
R[integer n] = bits(32) value
    assert n >= 0 && n <= 14;
```

The full operation of this function is explained in *Pseudocode details of ARM core register operations* on page B1-12.

Descriptions of ARM store instructions that store the PC value use the PCStoreValue() pseudocode function to specify the PC value stored by the instruction:

```
// PCStoreValue()
// =====

bits(32) PCStoreValue()
    // This function returns the PC value. On architecture versions before ARMv7, it
    // is permitted to instead return PC+4, provided it does so consistently. It is
    // used only to describe ARM instructions, so it returns the address of the current
    // instruction plus 8 (normally) or 12 (when the alternative is permitted).
    return PC;
```

Writing an address to the PC causes either a simple branch to that address or an *interworking* branch that also selects the instruction set to execute after the branch. A simple branch is performed by the BranchWritePC() function:

```
// BranchWritePC()
// =====

BranchWritePC(bits(32) address)
    if CurrentInstrSet() == InstrSet_ARM then
        if ArchVersion() < 6 && address<1:0> != '00' then UNPREDICTABLE;
        BranchTo(address<31:2>:'00');
    else
        BranchTo(address<31:1>:'0');
```

An interworking branch is performed by the BXWritePC() function:

```

// BXWritePC()
// =====

BXWritePC(bits(32) address)
  if CurrentInstrSet() == InstrSet_ThumbEE then
    if address<0> == '1' then
      BranchTo(address<31:1>:'0'); // Remaining in ThumbEE state
    else
      UNPREDICTABLE;
  else
    if address<0> == '1' then
      SelectInstrSet(InstrSet_Thumb);
      BranchTo(address<31:1>:'0');
    elseif address<1> == '0' then
      SelectInstrSet(InstrSet_ARM);
      BranchTo(address);
    else // address<1:0> == '10'
      UNPREDICTABLE;

```

The LoadWritePC() and ALUWritePC() functions are used for two cases where the behavior was systematically modified between architecture versions:

```

// LoadWritePC()
// =====

LoadWritePC(bits(32) address)
  if ArchVersion() >= 5 then
    BXWritePC(address);
  else
    BranchWritePC(address);

// ALUWritePC()
// =====

ALUWritePC(bits(32) address)
  if ArchVersion() >= 7 && CurrentInstrSet() == InstrSet_ARM then
    BXWritePC(address);
  else
    BranchWritePC(address);

```

Note

The behavior of the PC writes performed by the ALUWritePC() function is different in Debug state, where there are more UNPREDICTABLE cases. The pseudocode in this section only handles the non-debug cases. For more information, see *Data-processing instructions with the PC as the target in Debug state* on page C5-12.

A2.4 The Application Program Status Register (APSR)

Program status is reported in the 32-bit *Application Program Status Register* (APSR). The format of the APSR is:

31	30	29	28	27	26	24	23	20	19	16	15	0
N	Z	C	V	Q	RAZ/ SBZP	Reserved		GE[3:0]		Reserved		

In the APSR, the bits are in the following categories:

- Reserved bits are allocated to system features, or are available for future expansion. Unprivileged execution ignores writes to privileged fields. However, application level software that writes to the APSR must treat reserved bits as Do-Not-Modify (DNM) bits. For more information about the reserved bits, see *Format of the CPSR and SPSRs* on page B1-16.
- Flags that can be set by many instructions:
 - N, bit [31]** Negative condition code flag. Set to bit [31] of the result of the instruction. If the result is regarded as a two's complement signed integer, then $N == 1$ if the result is negative and $N == 0$ if it is positive or zero.
 - Z, bit [30]** Zero condition code flag. Set to 1 if the result of the instruction is zero, and to 0 otherwise. A result of zero often indicates an equal result from a comparison.
 - C, bit [29]** Carry condition code flag. Set to 1 if the instruction results in a carry condition, for example an unsigned overflow on an addition.
 - V, bit [28]** Overflow condition code flag. Set to 1 if the instruction results in an overflow condition, for example a signed overflow on an addition.
 - Q, bit [27]** Set to 1 to indicate overflow or saturation occurred in some instructions, normally related to *Digital Signal Processing* (DSP). For more information, see *Pseudocode details of saturation* on page A2-9.
- GE[3:0], bits [19:16]**
 - Greater than or Equal flags. SIMD instructions update these flags to indicate the results from individual bytes or halfwords of the operation. These flags can control a later SEL instruction. For more information, see *SEL* on page A8-312.
- Bits [26:24] are RAZ/SBZP. Therefore, software can use MSR instructions that write the top byte of the APSR without using a read, modify, write sequence. If it does this, it must write zeros to bits [26:24].

Instructions can test the N, Z, C, and V condition code flags to determine whether the instruction is to be executed. In this way, execution of the instruction can be made conditional on the result of a previous operation. For more information about conditional execution see *Conditional execution* on page A4-3 and *Conditional execution* on page A8-8.

In ARMv7-A and ARMv7-R, the APSR is the same register as the CPSR, but the APSR must be used only to access the N, Z, C, V, Q, and GE[3:0] bits. For more information, see *Program Status Registers (PSRs)* on page B1-14.

A2.5 Execution state registers

The execution state registers modify the execution of instructions. They control:

- Whether instructions are interpreted as Thumb instructions, ARM instructions, ThumbEE instructions, or Java bytecodes. For more information, see *ISETSTATE*.
- In Thumb state and ThumbEE state only, what conditions apply to the next four instructions. For more information, see *ITSTATE* on page A2-17.
- Whether data is interpreted as big-endian or little-endian. For more information, see *ENDIANSTATE* on page A2-19.

In ARMv7-A and ARMv7-R, the execution state registers are part of the Current Program Status Register. For more information, see *Program Status Registers (PSRs)* on page B1-14.

There is no direct access to the execution state registers from application level instructions, but they can be changed by side effects of application level instructions.

A2.5.1 ISETSTATE



The J bit and the T bit determine the instruction set used by the processor. Table A2-1 shows the encoding of these bits.

Table A2-1 J and T bit encoding in ISETSTATE

J	T	Instruction set state
0	0	ARM
0	1	Thumb
1	0	Jazelle
1	1	ThumbEE

ARM state The processor executes the ARM instruction set described in Chapter A5 *ARM Instruction Set Encoding*.

Thumb state The processor executes the Thumb instruction set as described in Chapter A6 *Thumb Instruction Set Encoding*.

Jazelle state The processor executes Java bytecodes as part of a *Java Virtual Machine (JVM)*. For more information, see *Jazelle direct bytecode execution support* on page A2-73.

ThumbEE state The processor executes a variation of the Thumb instruction set specifically targeted for use with dynamic compilation techniques associated with an execution environment. This can be Java or other execution environments. This feature is required in ARMv7-A, and optional in ARMv7-R. For more information, see *Thumb Execution Environment* on page A2-69.

Pseudocode details of ISETSTATE operations

The following pseudocode functions return the current instruction set and select a new instruction set:

```
enumeration InstrSet {InstrSet_ARM, InstrSet_Thumb, InstrSet_Jazelle, InstrSet_ThumbEE};
```

```
// CurrentInstrSet()
// =====
```

```
InstrSet CurrentInstrSet()
  case ISETSTATE of
    when '00' result = InstrSet_ARM;
    when '01' result = InstrSet_Thumb;
    when '10' result = InstrSet_Jazelle;
    when '11' result = InstrSet_ThumbEE;
  return result;
```

```
// SelectInstrSet()
// =====
```

```
SelectInstrSet(InstrSet iset)
  case iset of
    when InstrSet_ARM
      if CurrentInstrSet() == InstrSet_ThumbEE then
        UNPREDICTABLE;
      else
        ISETSTATE = '00';
    when InstrSet_Thumb
      ISETSTATE = '01';
    when InstrSet_Jazelle
      ISETSTATE = '10';
    when InstrSet_ThumbEE
      ISETSTATE = '11';
  return;
```

A2.5.2 ITSTATE

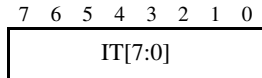

This field holds the If-Then execution state bits for the Thumb IT instruction. See *IT* on page A8-104 for a description of the IT instruction and the associated IT block.

ITSTATE divides into two subfields:

IT[7:5] Holds the *base condition* for the current IT block. The base condition is the top 3 bits of the condition specified by the IT instruction.

This subfield is 0b000 when no IT block is active.

IT[4:0] Encodes:

- The size of the IT block. This is the number of instructions that are to be conditionally executed. The size of the block is implied by the position of the least significant 1 in this field, as shown in Table A2-2 on page A2-18.
- The value of the least significant bit of the condition code for each instruction in the block.

———— **Note** —————

Changing the value of the least significant bit of a condition code from 0 to 1 has the effect of inverting the condition code.

This subfield is 0b00000 when no IT block is active.

When an IT instruction is executed, these bits are set according to the condition in the instruction, and the *Then* and *Else* (T and E) parameters in the instruction. For more information, see *IT* on page A8-104.

An instruction in an IT block is conditional, see *Conditional instructions* on page A4-4 and *Conditional execution* on page A8-8. The condition used is the current value of IT[7:4]. When an instruction in an IT block completes its execution normally, ITSTATE is advanced to the next line of Table A2-2 on page A2-18.

For details of what happens if such an instruction takes an exception see *Exception entry* on page B1-34.

———— **Note** —————

Instructions that can complete their normal execution by branching are only permitted in an IT block as its last instruction, and so always result in ITSTATE advancing to normal execution.

———— **Note** —————

ITSTATE affects instruction execution only in Thumb and ThumbEE states. In ARM and Jazelle states, ITSTATE must be '00000000', otherwise behavior is UNPREDICTABLE.

Table A2-2 Effect of IT execution state bits

[7:5]	IT bits ^a					Note
	[4]	[3]	[2]	[1]	[0]	
cond_base	P1	P2	P3	P4	1	Entry point for 4-instruction IT block
cond_base	P1	P2	P3	1	0	Entry point for 3-instruction IT block
cond_base	P1	P2	1	0	0	Entry point for 2-instruction IT block
cond_base	P1	1	0	0	0	Entry point for 1-instruction IT block
000	0	0	0	0	0	Normal execution, not in an IT block

a. Combinations of the IT bits not shown in this table are reserved.

Pseudocode details of ITSTATE operations

ITSTATE advances after normal execution of an IT block instruction. This is described by the ITAdvance() pseudocode function:

```
// ITAdvance()
// =====

ITAdvance()
  if ITSTATE<2:0> == '000' then
    ITSTATE.IT = '00000000';
  else
    ITSTATE.IT<4:0> = LSL(ITSTATE.IT<4:0>, 1);
```

The following functions test whether the current instruction is in an IT block, and whether it is the last instruction of an IT block:

```
// InITBlock()
// =====

boolean InITBlock()
  return (ITSTATE.IT<3:0> != '0000');

// LastInITBlock()
// =====

boolean LastInITBlock()
  return (ITSTATE.IT<3:0> == '1000');
```

A2.5.3 ENDIANSTATE

ARMv7-A and ARMv7-R support configuration between little-endian and big-endian interpretations of data memory, as shown in Table A2-3. The endianness is controlled by ENDIANSTATE.

Table A2-3 APSR configuration of endianness

ENDIANSTATE	Endian mapping
0	Little-endian
1	Big-endian

The ARM and Thumb instruction sets both include an instruction to manipulate ENDIANSTATE:

SETEND BE Sets ENDIANSTATE to 1, for big-endian operation

SETEND LE Sets ENDIANSTATE to 0, for little-endian operation.

The SETEND instruction is unconditional. For more information, see *SETEND* on page A8-314.

Pseudocode details of ENDIANSTATE operations

The BigEndian() pseudocode function tests whether big-endian memory accesses are currently selected.

```
// BigEndian()
// =====

boolean BigEndian()
    return (ENDIANSTATE == '1');
```

A2.6 Advanced SIMD and VFP extensions

Advanced SIMD and VFP are two optional extensions to ARMv7.

Advanced SIMD performs packed *Single Instruction Multiple Data* (SIMD) operations, either integer or single-precision floating-point. VFP performs single-precision or double-precision floating-point operations.

Both extensions permit *floating-point exceptions*, such as overflow or division by zero, to be handled in an untrapped fashion. When handled in this way, a floating-point exception causes a cumulative status register bit to be set to 1 and a default result to be produced by the operation.

The ARMv7 VFP implementation is VFPv3. ARMv7 also permits a variant of VFPv3, VFPv3U, that supports the trapping of floating-point exceptions, see *VFPv3U* on page A2-31. VFPv2 also supports the trapping of floating-point exceptions.

For more information about floating-point exceptions see *Floating-point exceptions* on page A2-42.

Each extension can be implemented at a number of levels. Table A2-4 shows the permitted combinations of implementations of the two extensions.

Table A2-4 Permitted combinations of Advanced SIMD and VFP extensions

Advanced SIMD	VFP
Not implemented	Not implemented
Integer only	Not implemented
Integer and single-precision floating-point	Single-precision floating-point only ^a
Integer and single-precision floating-point	Single-precision and double-precision floating-point
Not implemented	Single-precision floating-point only ^a
Not implemented	Single-precision and double-precision floating-point

a. Must be able to load and store double-precision data.

The optional half-precision extensions provide conversion functions in both directions between half-precision floating-point and single-precision floating-point. These extensions can be implemented with any Advanced SIMD and VFP implementation that supports single-precision floating-point. The half-precision extensions apply to both VFP and Advanced SIMD if they are both implemented.

For system-level information about the Advanced SIMD and VFP extensions see:

- *Advanced SIMD and VFP extension system registers* on page B1-66
- *Advanced SIMD and floating-point support* on page B1-64.

Note

Before ARMv7, the VFP extension was called the *Vector Floating-point Architecture*, and was used for vector operations. For details of these deprecated operations see Appendix F *VFP Vector Operation Support*. From ARMv7:

- ARM recommends that the Advanced SIMD extension is used for single-precision vector floating-point operations
 - an implementation that requires support for vector operations must implement the Advanced SIMD extension.
-

A2.6.1 Advanced SIMD and VFP extension registers

Advanced SIMD and VFPv3 use the same register set. This is distinct from the ARM core register set. These registers are generally referred to as the *extension registers*.

The extension register set consists of either thirty-two or sixteen doubleword registers, as follows:

- If VFPv2 is implemented, it consists of sixteen doubleword registers.
- If VFPv3 is implemented, it consists of either thirty-two or sixteen doubleword registers. Where necessary the terms VFPv3-D32 and VFPv3-D16 are used to distinguish between these two implementation options.
- If Advanced SIMD is implemented, it consists of thirty-two doubleword registers. If both Advanced SIMD and VFPv3 are implemented, VFPv3 must be implemented in its VFPv3-D32 form.

The Advanced SIMD and VFP views of the extension register set are not identical. They are described in the following sections.

Figure A2-1 on page A2-22 shows the views of the extension register set, and the way the word, doubleword, and quadword registers overlap.

Advanced SIMD views of the extension register set

Advanced SIMD can view this register set as:

- Sixteen 128-bit quadword registers, Q0-Q15.
- Thirty-two 64-bit doubleword registers, D0-D31. This view is also available in VFPv3.

These views can be used simultaneously. For example, a program might hold 64-bit vectors in D0 and D1 and a 128-bit vector in Q1.

VFP views of the extension register set

In VFPv3-D32, the extension register set consists of thirty-two doubleword registers, that VFP can view as:

- Thirty-two 64-bit doubleword registers, D0-D31. This view is also available in Advanced SIMD.
- Thirty-two 32-bit single word registers, S0-S31. Only half of the set is accessible in this view.

In VFPv3-D16 and VFPv2, the extension register set consists of sixteen doubleword registers, that VFP can view as:

- Sixteen 64-bit doubleword registers, D0-D15.
- Thirty-two 32-bit single word registers, S0-S31.

In each case, the two views can be used simultaneously.

Advanced SIMD and VFP register mapping

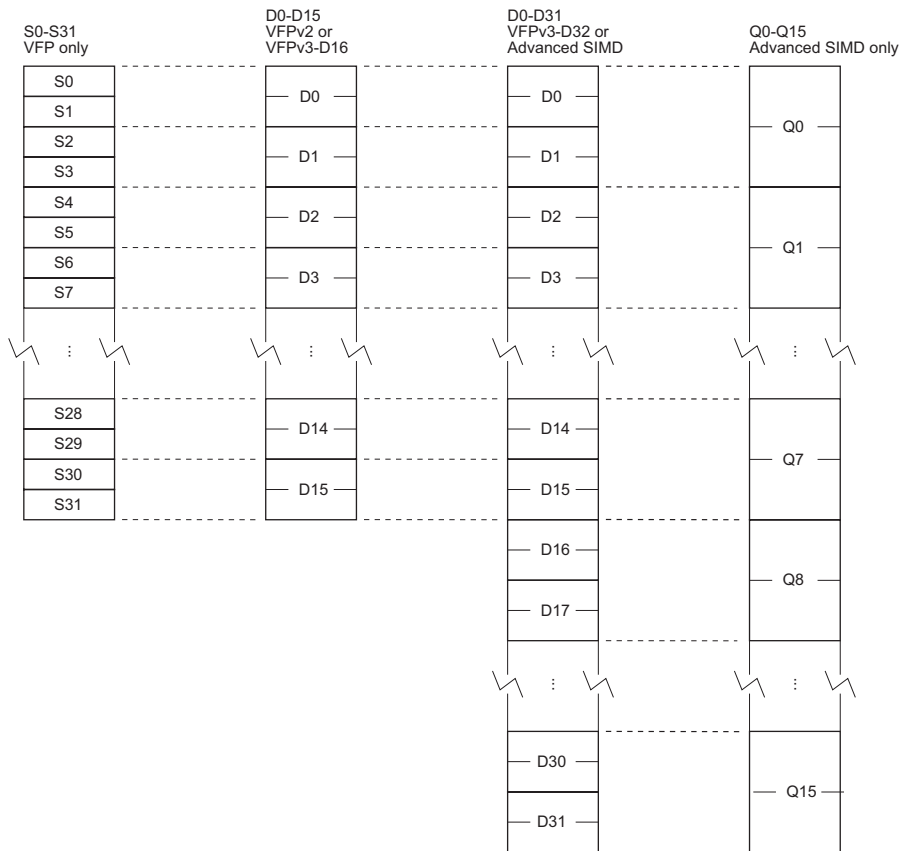

Figure A2-1 Advanced SIMD and VFP register set

The mapping between the registers is as follows:

- S<2n> maps to the least significant half of D<n>
- S<2n+1> maps to the most significant half of D<n>
- D<2n> maps to the least significant half of Q<n>
- D<2n+1> maps to the most significant half of Q<n>.

For example, you can access the least significant half of the elements of a vector in Q6 by referring to D12, and the most significant half of the elements by referring to D13.

Pseudocode details of Advanced SIMD and VFP extension registers

The pseudocode function `VFPsmallRegisterBank()` returns FALSE if all of the 32 registers D0-D31 can be accessed, and TRUE if only the 16 registers D0-D15 can be accessed:

```
boolean VFPsmallRegisterBank()
```

In more detail, `VFPsmallRegisterBank()`:

- returns TRUE for a VFPv2 or VFPv3-D16 implementation
- for a VFPv3-D32 implementation:
 - returns FALSE if `CPACR.D32DIS == 0`
 - returns TRUE if `CPACR.D32DIS == 1` and `CPACR.ASEDIS == 1`
 - results in UNPREDICTABLE behavior if `CPACR.D32DIS == 1` and `CPACR.ASEDIS == 0`.

For details of the CPACR register, see:

- *c1, Coprocessor Access Control Register (CPACR)* on page B3-104 for a VMSA implementation
- *c1, Coprocessor Access Control Register (CPACR)* on page B4-51 for a PMSA implementation.

The S0-S31, D0-D31, and Q0-Q15 views of the registers are provided by the following functions:

```
// The 64-bit extension register bank for Advanced SIMD and VFP.
```

```
array bits(64) _D[0..31];
```

```
// S[] - non-assignment form
// =====
```

```
bits(32) S[integer n]
  assert n >= 0 && n <= 31;
  if (n MOD 2) == 0 then
    result = D[n DIV 2]<31:0>;
  else
    result = D[n DIV 2]<63:32>;
  return result;
```

```
// S[] - assignment form
// =====
```

```
S[integer n] = bits(32) value
  assert n >= 0 && n <= 31;
  if (n MOD 2) == 0 then
```

```

        D[n DIV 2]<31:0> = value;
    else
        D[n DIV 2]<63:32> = value;
    return;

// D[] - non-assignment form
// =====

bits(64) D[integer n]
    assert n >= 0 && n <= 31;
    if n >= 16 && VFPSmallRegisterBank() then UNDEFINED;
    return _D[n];

// D[] - assignment form
// =====

D[integer n] = bits(64) value
    assert n >= 0 && n <= 31;
    if n >= 16 && VFPSmallRegisterBank() then UNDEFINED;
    _D[n] = value;
    return;

// Q[] - non-assignment form
// =====

bits(128) Q[integer n]
    assert n >= 0 && n <= 15;
    return D[2*n+1]:D[2*n];

// Q[] - assignment form
// =====

Q[integer n] = bits(128) value
    assert n >= 0 && n <= 15;
    D[2*n] = value<63:0>;
    D[2*n+1] = value<127:64>;
    return;

```

A2.6.2 Data types supported by the Advanced SIMD extension

When the Advanced SIMD extension is implemented, it can operate on integer and floating-point data. It defines a set of data types to represent the different data formats. Table A2-5 shows the available formats. Each instruction description specifies the data types that the instruction supports.

Table A2-5 Advanced SIMD data types

Data type specifier	Meaning
.<size>	Any element of <size> bits
.F<size>	Floating-point number of <size> bits
.I<size>	Signed or unsigned integer of <size> bits
.P<size>	Polynomial over {0,1} of degree less than <size>
.S<size>	Signed integer of <size> bits
.U<size>	Unsigned integer of <size> bits

The polynomial data type is described in *Polynomial arithmetic over {0,1}* on page A2-67.

The .F16 data type is the half-precision data type currently selected by the FPSCR.AHP bit, see *Advanced SIMD and VFP system registers* on page A2-28. It is supported only when the half-precision extensions are implemented.

The .F32 data type is the ARM standard single-precision floating-point data type, see *Advanced SIMD and VFP single-precision format* on page A2-34.

The instruction definitions use a data type specifier to define the data types appropriate to the operation. Figure A2-2 on page A2-26 shows the hierarchy of Advanced SIMD data types.

.8	.i8	.S8
		.U8
	.P8	
	-	
.16	.i16	.S16
		.U16
	.P16	
	.F16 ‡	
.32	.i32	.S32
		.U32
	-	
	.F32	
.64	.i64	.S64
		.U64
	-	
	-	

‡ Supported only if the half-precision extensions are implemented

Figure A2-2 Advanced SIMD data type hierarchy

For example, a multiply instruction must distinguish between integer and floating-point data types. However, some multiply instructions use modulo arithmetic for integer instructions and therefore do not need to distinguish between signed and unsigned inputs.

A multiply instruction that generates a double-width (long) result must specify the input data types as signed or unsigned, because for this operation it does make a difference.

A2.6.3 Advanced SIMD vectors

When the Advanced SIMD extension is implemented, a register can hold one or more packed elements, all of the same size and type. The combination of a register and a data type describes a vector of elements. The vector is considered to be an array of elements of the data type specified in the instruction. The number of elements in the vector is implied by the size of the data elements and the size of the register.

Vector indices are in the range 0 to (number of elements – 1). An index of 0 refers to the least significant end of the vector. Figure A2-3 on page A2-27 shows examples of Advanced SIMD vectors:

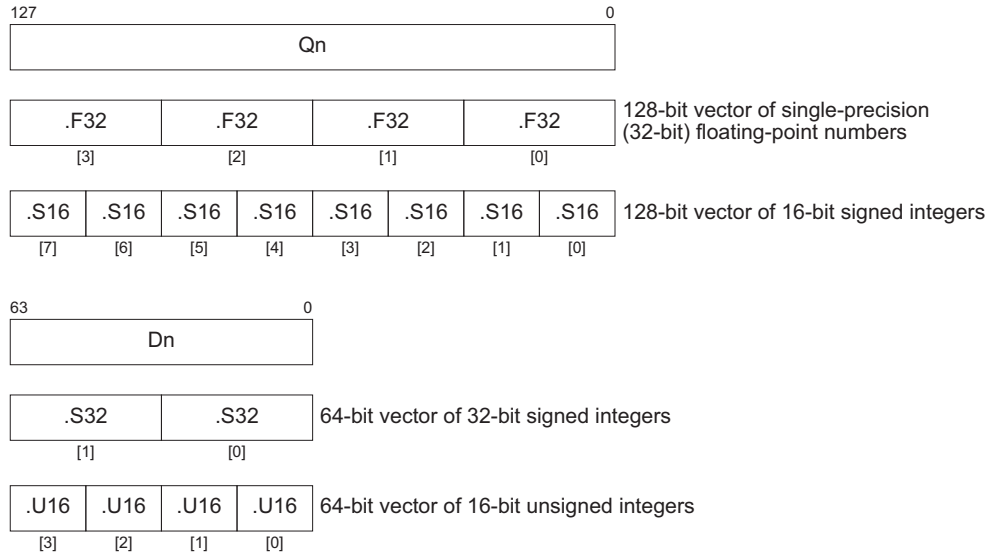

Figure A2-3 Examples of Advanced SIMD vectors

Pseudocode details of Advanced SIMD vectors

The pseudocode function Elem[] is used to access the element of a specified index and size in a vector:

```
// Elem[] - non-assignment form
// =====

bits(size) Elem[bits(N) vector, integer e, integer size]
    assert e >= 0 && (e+1)*size <= N;
    return vector<(e+1)*size-1:e*size>;

// Elem[] - assignment form
// =====

Elem[bits(N) vector, integer e, integer size] = bits(size) value
    assert e >= 0 && (e+1)*size <= N;
    vector<(e+1)*size-1:e*size> = value;
    return;
```

A2.6.4 Advanced SIMD and VFP system registers

The Advanced SIMD and VFP extensions have a shared register space for system registers. Only one register in this space is accessible at the application level, see *Floating-point Status and Control Register (FPSCR)*.

See *Advanced SIMD and VFP extension system registers* on page B1-66 for the system level description of the registers.

Floating-point Status and Control Register (FPSCR)

The Floating-point Status and Control Register (FPSCR) is implemented in any system that implements one or both of:

- the VFP extension
- the Advanced SIMD extension.

The FPSCR provides all necessary User level control of the floating-point system

The FPSCR is a 32-bit read/write system register, accessible in unprivileged and privileged modes.

The format of the FPSCR is:

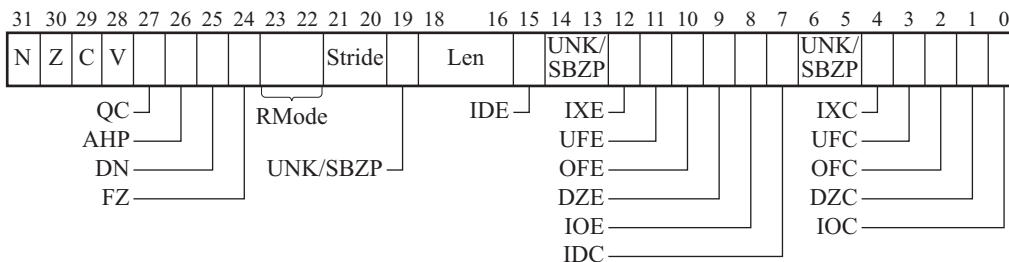

Bits [31:28] Condition code bits. These are updated on floating-point comparison operations. They are not updated on SIMD operations, and do not affect SIMD instructions.

N, bit [31] Negative condition code flag.

Z, bit [30] Zero condition code flag.

C, bit [29] Carry condition code flag.

V, bit [28] Overflow condition code flag.

QC, bit [27] Cumulative saturation flag, Advanced SIMD only. This bit is set to 1 to indicate that an Advanced SIMD integer operation has saturated since 0 was last written to this bit. For details of saturation, see *Pseudocode details of saturation* on page A2-9.

The value of this bit is ignored by the VFP extension. If Advanced SIMD is not implemented this bit is UNK/SBZP.

AHP, bit[26] Alternative half-precision control bit:

- 0** IEEE half-precision format selected.
- 1** Alternative half-precision format selected.

For more information see *Advanced SIMD and VFP half-precision formats* on page A2-38.

If the half-precision extensions are not implemented this bit is UNK/SBZP.

Bits [19,14:13,6:5]

Reserved. UNK/SBZP.

DN, bit [25] Default NaN mode control bit:

- 0** NaN operands propagate through to the output of a floating-point operation.
- 1** Any operation involving one or more NaNs returns the Default NaN.

For more information, see *NaN handling and the Default NaN* on page A2-41.

The value of this bit only controls VFP arithmetic. Advanced SIMD arithmetic always uses the Default NaN setting, regardless of the value of the DN bit.

FZ, bit [24] Flush-to-zero mode control bit:

- 0** Flush-to-zero mode disabled. Behavior of the floating-point system is fully compliant with the IEEE 754 standard.
- 1** Flush-to-zero mode enabled.

For more information, see *Flush-to-zero* on page A2-39.

The value of this bit only controls VFP arithmetic. Advanced SIMD arithmetic always uses the Flush-to-zero setting, regardless of the value of the FZ bit.

RMode, bits [23:22]

Rounding Mode control field. The encoding of this field is:

- 0b00** *Round to Nearest (RN) mode*
- 0b01** *Round towards Plus Infinity (RP) mode*
- 0b10** *Round towards Minus Infinity (RM) mode*
- 0b11** *Round towards Zero (RZ) mode.*

The specified rounding mode is used by almost all VFP floating-point instructions.

Advanced SIMD arithmetic always uses the Round to Nearest setting, regardless of the value of the RMode bits.

Stride, bits [21:20] and Len, bits [18:16]

Use of nonzero values of these fields is deprecated in ARMv7. For details of their use in previous versions of the ARM architecture see Appendix F *VFP Vector Operation Support*.

The values of these fields are ignored by the Advanced SIMD extension.

Bits [15,12:8] Floating-point exception trap enable bits. These bits are supported only in VFPv2 and VFPv3U. They are reserved, RAZ/SBZP, on a system that implements VFPv3.

The possible values of each bit are:

- 0** Untrapped exception handling selected
- 1** Trapped exception handling selected.

The values of these bits control only VFP arithmetic. Advanced SIMD arithmetic always uses untrapped exception handling, regardless of the values of these bits.

For more information, see *Floating-point exceptions* on page A2-42.

- IDE, bit [15]** Input Denormal exception trap enable.
- IXE, bit [12]** Inexact exception trap enable.
- UFE, bit [11]** Underflow exception trap enable.
- OFE, bit [10]** Overflow exception trap enable.
- DZE, bit [9]** Division by Zero exception trap enable.
- IOE, bit [8]** Invalid Operation exception trap enable.

Bits [7,4:0] Cumulative exception flags for floating-point exceptions. Each of these bits is set to 1 to indicate that the corresponding exception has occurred since 0 was last written to it. How VFP instructions update these bits depends on the value of the corresponding exception trap enable bits:

Trap enable bit = 0

If the floating-point exception occurs then the cumulative exception flag is set to 1.

Trap enable bit = 1

If the floating-point exception occurs the trap handling software can decide whether to set the cumulative exception flag to 1.

Advanced SIMD instructions set each cumulative exception flag if the corresponding exception occurs in one or more of the floating-point calculations performed by the instruction, regardless of the setting of the trap enable bits.

For more information, see *Floating-point exceptions* on page A2-42.

- IDC, bit [7]** Input Denormal cumulative exception flag.
- IXC, bit [4]** Inexact cumulative exception flag.
- UFC, bit [3]** Underflow cumulative exception flag.
- OFC, bit [2]** Overflow cumulative exception flag.
- DZC, bit [1]** Division by Zero cumulative exception flag.
- IOC, bit [0]** Invalid Operation cumulative exception flag.

If the processor implements the integer-only Advanced SIMD extension and does not implement the VFP extension, all of these bits except QC are UNK/SBZP.

Writes to the FPSCR can have side-effects on various aspects of processor operation. All of these side-effects are synchronous to the FPSCR write. This means they are guaranteed not to be visible to earlier instructions in the execution stream, and they are guaranteed to be visible to later instructions in the execution stream.

Accessing the FPSCR

You read or write the FPSCR using the VMRS and VMSR instructions. For more information, see *VMRS* on page A8-658 and *VMSR* on page A8-660. For example:

```
VMRS <Rt>, FPSCR    ; Read Floating-point System Control Register
VMSR FPSCR, <Rt>    ; Write Floating-point System Control Register
```

A2.6.5 VFPv3U

VFPv3 does not support the exception trap enable bits in the FPSCR, see *Floating-point Status and Control Register (FPSCR)* on page A2-28. All floating-point exceptions are untrapped.

The VFPv3U variant of the VFPv3 architecture implements the exception trap enable bits in the FPSCR, and provides exception handling as described in *VFP support code* on page B1-70. There is a separate trap enable bit for each of the six floating-point exceptions described in *Floating-point exceptions* on page A2-42. The VFPv3U architecture is otherwise identical to VFPv3.

Trapped exception handling never causes the corresponding cumulative exception bit of the FPSCR to be set to 1. If this behavior is desired, the trap handler routine must use a read, modify, write sequence on the FPSCR to set the cumulative exception bit.

VFPv3U is backwards compatible with VFPv2.

A2.7 Floating-point data types and arithmetic

The VFP extension supports single-precision (32-bit) and double-precision (64-bit) floating-point data types and arithmetic as defined by the IEEE 754 floating-point standard. It also supports the *ARM Standard modifications* to that arithmetic described in *Flush-to-zero* on page A2-39 and *NaN handling and the Default NaN* on page A2-41.

Trapped floating-point exception handling is supported in the VFPv3U variant only (see *VFPv3U* on page A2-31).

ARM standard floating-point arithmetic means IEEE 754 floating-point arithmetic with the ARM standard modifications and:

- the Round to Nearest rounding mode selected
- untrapped exception handling selected for all floating-point exceptions.

The Advanced SIMD extension only supports single-precision ARM standard floating-point arithmetic.

————— Note —————

Implementations of the VFP extension require *support code* to be installed in the system if trapped floating-point exception handling is required. See *VFP support code* on page B1-70.

They might also require support code to be installed in the system to support other aspects of their floating-point arithmetic. It is IMPLEMENTATION DEFINED which aspects of VFP floating-point arithmetic are supported in a system without support code installed.

Aspects of floating-point arithmetic that are implemented in support code are likely to run much more slowly than those that are executed in hardware.

ARM recommends that:

- To maximize the chance of getting high floating-point performance, software developers use ARM standard floating-point arithmetic.
- Software developers check whether their systems have support code installed, and if not, observe the IMPLEMENTATION DEFINED restrictions on what operations their VFP implementation can handle without support code.
- VFP implementation developers implement at least ARM standard floating-point arithmetic in hardware, so that it can be executed without any need for support code.

A2.7.1 ARM standard floating-point input and output values

ARM standard floating-point arithmetic supports the following input formats defined by the IEEE 754 floating-point standard:

- Zeros.
- Normalized numbers.
- Denormalized numbers are flushed to 0 before floating-point operations. For details, see *Flush-to-zero* on page A2-39.
- NaNs.
- Infinities.

ARM standard floating-point arithmetic supports the Round to Nearest rounding mode defined by the IEEE 754 standard.

ARM standard floating-point arithmetic supports the following output result formats defined by the IEEE 754 standard:

- Zeros.
- Normalized numbers.
- Results that are less than the minimum normalized number are flushed to zero, see *Flush-to-zero* on page A2-39.
- NaNs produced in floating-point operations are always the default NaN, see *NaN handling and the Default NaN* on page A2-41.
- Infinities.

A2.7.2 Advanced SIMD and VFP single-precision format

The single-precision floating-point format used by the Advanced SIMD and VFP extensions is as defined by the IEEE 754 standard.

This description includes ARM-specific details that are left open by the standard. It is only intended as an introduction to the formats and to the values they can contain. For full details, especially of the handling of infinities, NaNs and signed zeros, see the IEEE 754 standard.

A single-precision value is a 32-bit word, and must be word-aligned when held in memory. It has the format:

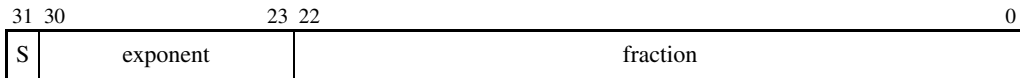

The interpretation of the format depends on the value of the exponent field, bits [30:23]:

0 < exponent < 0xFF

The value is a *normalized number* and is equal to:

$$-1^S \times 2^{(\text{exponent} - 127)} \times (1.\text{fraction})$$

The minimum positive normalized number is 2^{-126} , or approximately 1.175×10^{-38} .

The maximum positive normalized number is $(2 - 2^{-23}) \times 2^{127}$, or approximately 3.403×10^{38} .

exponent == 0

The value is either a zero or a *denormalized number*, depending on the fraction bits:

fraction == 0

The value is a zero. There are two distinct zeros:

+0 when S==0

-0 when S==1.

These usually behave identically. In particular, the result is *equal* if +0 and -0 are compared as floating-point numbers. However, they yield different results in some circumstances. For example, the sign of the infinity produced as the result of dividing by zero depends on the sign of the zero. The two zeros can be distinguished from each other by performing an integer comparison of the two words.

fraction != 0

The value is a denormalized number and is equal to:

$$-1^S \times 2^{-126} \times (0.\text{fraction})$$

The minimum positive denormalized number is 2^{-149} , or approximately 1.401×10^{-45} .

Denormalized numbers are flushed to zero in the Advanced SIMD extension. They are optionally flushed to zero in the VFP extension. For details see *Flush-to-zero* on page A2-39.

exponent == 0xFF

The value is either an *infinity* or a *Not a Number* (NaN), depending on the fraction bits:

fraction == 0

The value is an infinity. There are two distinct infinities:

- +∞ When S==0. This represents all positive numbers that are too big to be represented accurately as a normalized number.
- ∞ When S==1. This represents all negative numbers with an absolute value that is too big to be represented accurately as a normalized number.

fraction != 0

The value is a NaN, and is either a *quiet NaN* or a *signaling NaN*.

In the VFP architecture, the two types of NaN are distinguished on the basis of their most significant fraction bit, bit [22]:

bit [22] == 0

The NaN is a signaling NaN. The sign bit can take any value, and the remaining fraction bits can take any value except all zeros.

bit [22] == 1

The NaN is a quiet NaN. The sign bit and remaining fraction bits can take any value.

For details of the *default NaN* see *NaN handling and the Default NaN* on page A2-41.

———— **Note** —————

NaNs with different sign or fraction bits are distinct NaNs, but this does not mean you can use floating-point comparison instructions to distinguish them. This is because the IEEE 754 standard specifies that a NaN compares as *unordered* with everything, including itself. However, you can use integer comparisons to distinguish different NaNs.

A2.7.3 VFP double-precision format

The double-precision floating-point format used by the VFP extension is as defined by the IEEE 754 standard.

This description includes VFP-specific details that are left open by the standard. It is only intended as an introduction to the formats and to the values they can contain. For full details, especially of the handling of infinities, NaNs and signed zeros, see the IEEE 754 standard.

A double-precision value consists of two 32-bit words, with the formats:

Most significant word:

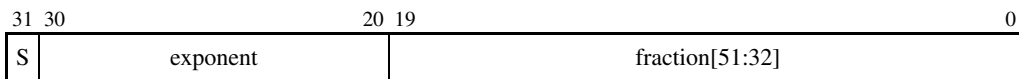

Least significant word:

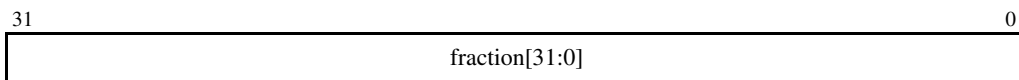

When held in memory, the two words must appear consecutively and must both be word-aligned. The order of the two words depends on the endianness of the memory system:

- In a little-endian memory system, the least significant word appears at the lower memory address and the most significant word at the higher memory address.
- In a big-endian memory system, the most significant word appears at the lower memory address and the least significant word at the higher memory address.

Double-precision values represent numbers, infinities and NaNs in a similar way to single-precision values, with the interpretation of the format depending on the value of the exponent:

0 < exponent < 0x7FF

The value is a normalized number and is equal to:

$$-1^S \times 2^{\text{exponent}-1023} \times (1.\text{fraction})$$

The minimum positive normalized number is 2^{-1022} , or approximately 2.225×10^{-308} .

The maximum positive normalized number is $(2 - 2^{-52}) \times 2^{1023}$, or approximately 1.798×10^{308} .

exponent == 0

The value is either a zero or a denormalized number, depending on the fraction bits:

fraction == 0

The value is a zero. There are two distinct zeros that behave analogously to the two single-precision zeros:

+0 when S==0

-0 when S==1.

fraction != 0

The value is a denormalized number and is equal to:

$$1-S \times 2^{-1022} \times (0.\text{fraction})$$

The minimum positive denormalized number is 2^{-1074} , or approximately 4.941×10^{-324} .

Optionally, denormalized numbers are flushed to zero in the VFP extension. For details see *Flush-to-zero* on page A2-39.

exponent == 0x7FF

The value is either an infinity or a NaN, depending on the fraction bits:

fraction == 0

the value is an infinity. As for single-precision, there are two infinities:

$+\infty$ Plus infinity, when $S==0$

$-\infty$ Minus infinity, when $S==1$.

fraction != 0

The value is a NaN, and is either a *quiet NaN* or a *signaling NaN*.

In the VFP architecture, the two types of NaN are distinguished on the basis of their most significant fraction bit, bit [19] of the most significant word:

bit [19] == 0

The NaN is a signaling NaN. The sign bit can take any value, and the remaining fraction bits can take any value except all zeros.

bit [19] == 1

The NaN is a quiet NaN. The sign bit and the remaining fraction bits can take any value.

For details of the *default NaN* see *NaN handling and the Default NaN* on page A2-41.

A2.7.4 Advanced SIMD and VFP half-precision formats

Two half-precision floating-point formats are used by the half-precision extensions to Advanced SIMD and VFP:

- IEEE half-precision, as described in the revised IEEE 754 standard
- Alternative half-precision.

The description of IEEE half-precision includes ARM-specific details that are left open by the standard, and is only an introduction to the formats and to the values they can contain. For more information, especially on the handling of infinities, NaNs and signed zeros, see the IEEE 754 standard.

For both half-precision floating-point formats, the layout of the 16-bit number is the same. The format is:

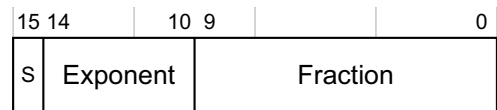

The interpretation of the format depends on the value of the exponent field, bits[14:10] and on which half-precision format is being used.

0 < exponent < 0x1F

The value is a normalized number and is equal to:

$$-1^S \times 2^{((\text{exponent}-15) \times (1.\text{fraction}))}$$

The minimum positive normalized number is 2^{-14} , or approximately 6.104×10^{-5} .

The maximum positive normalized number is $(2 - 2^{-10}) \times 2^{15}$, or 65504.

Larger normalized numbers can be expressed using the alternative format when the exponent == 0x1F.

exponent == 0

The value is either a zero or a denormalized number, depending on the fraction bits:

fraction == 0

The value is a zero. There are two distinct zeros:

+0 when S==0

-0 when S==1.

fraction != 0

The value is a denormalized number and is equal to:

$$-1^S \times 2^{-14} \times (0.\text{fraction})$$

The minimum positive denormalized number is 2^{-25} , or approximately 2.980×10^{-8} .

exponent == 0x1F

The value depends on which half-precision format is being used:

IEEE Half-precision

The value is either an infinity or a Not a Number (NaN), depending on the fraction bits:

fraction == 0

The value is an infinity. There are two distinct infinities:

$+\infty$	When $S==0$. This represents all positive numbers that are too big to be represented accurately as a normalized number.
$-\infty$	When $S==1$. This represents all negative numbers with an absolute value that is too big to be represented accurately as a normalized number.

fraction != 0

The value is a NaN, and is either a quiet NaN or a signaling NaN. The two types of NaN are distinguished by their most significant fraction bit, bit [9]:

bit [9] == 0	The NaN is a signaling NaN. The sign bit can take any value, and the remaining fraction bits can take any value except all zeros.
bit [9] == 1	The NaN is a quiet NaN. The sign bit and remaining fraction bits can take any value.

Alternative Half-precision

The value is a normalized number and is equal to:

$$-1^S \times 2^{16} \times (1.\text{fraction})$$

The maximum positive normalized number is $(2-2^{-10}) \times 2^{16}$ or 131008.

A2.7.5 Flush-to-zero

The performance of floating-point implementations can be significantly reduced when performing calculations involving denormalized numbers and Underflow exceptions. In particular this occurs for implementations that only handle normalized numbers and zeros in hardware, and invoke support code to handle any other types of value. For an algorithm where a significant number of the operands and intermediate results are denormalized numbers, this can result in a considerable loss of performance.

In many of these algorithms, this performance can be recovered, without significantly affecting the accuracy of the final result, by replacing the denormalized operands and intermediate results with zeros. To permit this optimization, VFP implementations have a special processing mode called *Flush-to-zero* mode. Advanced SIMD implementations always use Flush-to-zero mode.

Behavior in Flush-to-zero mode differs from normal IEEE 754 arithmetic in the following ways:

- All inputs to floating-point operations that are double-precision de-normalized numbers or single-precision de-normalized numbers are treated as though they were zero. This causes an Input Denormal exception, but does not cause an Inexact exception. The Input Denormal exception occurs only in Flush-to-zero mode.

The FPSCR contains a cumulative exception bit FPSCR.IDC and trap enable bit FPSCR.IDE corresponding to the Input Denormal exception. For details of how these are used when processing the exception see *Advanced SIMD and VFP system registers* on page A2-28.

The occurrence of all exceptions except Input Denormal is determined using the input values after flush-to-zero processing has occurred.

- The result of a floating-point operation is flushed to zero if the result of the operation before rounding satisfies the condition:

$0 < \text{Abs}(\text{result}) < \text{MinNorm}$, where:

— $\text{MinNorm} == 2^{-126}$ for single-precision

— $\text{MinNorm} == 2^{-1022}$ for double-precision.

This causes the FPSCR.UFC bit to be set to 1, and prevents any Inexact exception from occurring for the operation.

Underflow exceptions occur only when a result is flushed to zero.

In a VFPv2 or VFPv3U implementation Underflow exceptions that occur in Flush-to-zero mode are always treated as untrapped, even when the Underflow trap enable bit, FPSCR.UFE, is set to 1.

- An Inexact exception does not occur if the result is flushed to zero, even though the final result of zero is not equivalent to the value that would be produced if the operation were performed with unbounded precision and exponent range.

For information on the FPSCR bits see *Floating-point Status and Control Register (FPSCR)* on page A2-28.

When an input or a result is flushed to zero the value of the sign bit of the zero is determined as follows:

- In VFPv3 or VFPv3U, it is preserved. That is, the sign bit of the zero matches the sign bit of the input or result that is being flushed to zero.
- In VFPv2, it is IMPLEMENTATION DEFINED whether it is preserved or always positive. The same choice must be made for all cases of flushing an input or result to zero.

Flush-to-zero mode has no effect on half-precision numbers that are inputs to floating-point operations, or results from floating-point operations.

Note

Flush-to-zero mode is incompatible with the IEEE 754 standard, and must not be used when IEEE 754 compatibility is a requirement. Flush-to-zero mode must be treated with care. Although it can lead to a major performance increase on many algorithms, there are significant limitations on its use. These are application dependent:

- On many algorithms, it has no noticeable effect, because the algorithm does not normally use denormalized numbers.
 - On other algorithms, it can cause exceptions to occur or seriously reduce the accuracy of the results of the algorithm.
-

A2.7.6 NaN handling and the Default NaN

The IEEE 754 standard specifies that:

- an operation that produces an Invalid Operation floating-point exception generates a quiet NaN as its result if that exception is untrapped
- an operation involving a quiet NaN operand, but not a signaling NaN operand, returns an input NaN as its result.

The VFP behavior when Default NaN mode is disabled adheres to this with the following extra details, where the *first operand* means the first argument to the pseudocode function call that describes the operation:

- If an untrapped Invalid Operation floating-point exception is produced because one of the operands is a signaling NaN, the quiet NaN result is equal to the signaling NaN with its most significant fraction bit changed to 1. If both operands are signaling NaNs, the result is produced in this way from the first operand.
- If an untrapped Invalid Operation floating-point exception is produced for other reasons, the quiet NaN result is the Default NaN.
- If both operands are quiet NaNs, the result is the first operand.

The VFP behavior when Default NaN mode is enabled, and the Advanced SIMD behavior in all circumstances, is that the Default NaN is the result of all floating-point operations that:

- generate untrapped Invalid Operation floating-point exceptions
- have one or more quiet NaN inputs.

Table A2-6 on page A2-42 shows the format of the default NaN for ARM floating-point processors.

Default NaN mode is selected for VFP by setting the FPSCR.DN bit to 1, see *Floating-point Status and Control Register (FPSCR)* on page A2-28.

Other aspects of the functionality of the Invalid Operation exception are not affected by Default NaN mode. These are that:

- If untrapped, it causes the FPSCR.IOC bit be set to 1.
- If trapped, it causes a user trap handler to be invoked. This is only possible in VFPv2 and VFPv3U.

Table A2-6 Default NaN encoding

	Half-precision, IEEE Format	Single-precision	Double-precision
Sign bit	0	0 ^a	0 ^a
Exponent	0x1F	0xFF	0x7FF
Fraction	Bit[9] == 1, bits[8:0] == 0	bit [22] == 1, bits [21:0] == 0	bit [51] == 1, bits [50:0] == 0

a. In VFPv2, the sign bit of the Default NaN is UNKNOWN.

A2.7.7 Floating-point exceptions

The Advanced SIMD and VFP extensions record the following floating-point exceptions in the FPSCR cumulative flags, see *Floating-point Status and Control Register (FPSCR)* on page A2-28:

IOC Invalid Operation. The flag is set to 1 if the result of an operation has no mathematical value or cannot be represented. Cases include infinity * 0, +infinity + (–infinity), for example. These tests are made after flush-to-zero processing. For example, if flush-to-zero mode is selected, multiplying a denormalized number and an infinity is treated as 0 * infinity and causes an Invalid Operation floating-point exception.

IOC is also set on any floating-point operation with one or more signaling NaNs as operands, except for negation and absolute value, as described in *Negation and absolute value* on page A2-47.

DZC Division by Zero. The flag is set to 1 if a divide operation has a zero divisor and a dividend that is not zero, an infinity or a NaN. These tests are made after flush-to-zero processing, so if flush-to-zero processing is selected, a denormalized dividend is treated as zero and prevents Division by Zero from occurring, and a denormalized divisor is treated as zero and causes Division by Zero to occur if the dividend is a normalized number.

For the reciprocal and reciprocal square root estimate functions the dividend is assumed to be +1.0. This means that a zero or denormalized operand to these functions sets the DZC flag.

OFC Overflow. The flag is set to 1 if the absolute value of the result of an operation, produced after rounding, is greater than the maximum positive normalized number for the destination precision.

UFC Underflow. The flag is set to 1 if the absolute value of the result of an operation, produced before rounding, is less than the minimum positive normalized number for the destination precision, and the rounded result is inexact.

The criteria for the Underflow exception to occur are different in Flush-to-zero mode. For details, see *Flush-to-zero* on page A2-39.

IXC Inexact. The flag is set to 1 if the result of an operation is not equivalent to the value that would be produced if the operation were performed with unbounded precision and exponent range.

The criteria for the Inexact exception to occur are different in Flush-to-zero mode. For details, see *Flush-to-zero* on page A2-39.

IDC Input Denormal. The flag is set to 1 if a denormalized input operand is replaced in the computation by a zero, as described in *Flush-to-zero* on page A2-39.

With the Advanced SIMD extension and the VFPv3 extension these are non-trapping exceptions and the data-processing instructions do not generate any trapped exceptions.

With the VFPv2 and VFPv3U extensions:

- These exceptions can be trapped, by setting trap enable flags in the FPSCR, see *VFPv3U* on page A2-31. Trapped floating-point exceptions are delivered to user code in an IMPLEMENTATION DEFINED fashion.
- The definitions of the floating-point exceptions change as follows:
 - if the Underflow exception is trapped, it occurs if the absolute value of the result of an operation, produced before rounding, is less than the minimum positive normalized number for the destination precision, regardless of whether the rounded result is inexact
 - higher priority trapped exceptions can prevent lower priority exceptions from occurring, as described in *Combinations of exceptions* on page A2-44.

Table A2-7 shows the default results of the floating-point exceptions:

Table A2-7 Floating-point exception default results

Exception type	Default result for positive sign	Default result for negative sign
IOC, Invalid Operation	Quiet NaN	Quiet NaN
DZC, Division by Zero	$+\infty$ (plus infinity)	$-\infty$ (minus infinity)
OFC, Overflow	RN, RP: $+\infty$ (plus infinity) RM, RZ: +MaxNorm	RN, RM: $-\infty$ (minus infinity) RP, RZ: -MaxNorm
UFC, Underflow	Normal rounded result	Normal rounded result
IXC, Inexact	Normal rounded result	Normal rounded result
IDC, Input Denormal	Normal rounded result	Normal rounded result

In Table A2-7 on page A2-43:

MaxNorm	The maximum normalized number of the destination precision
RM	Round towards Minus Infinity mode, as defined in the IEEE 754 standard
RN	Round to Nearest mode, as defined in the IEEE 754 standard
RP	Round towards Plus Infinity mode, as defined in the IEEE 754 standard
RZ	Round towards Zero mode, as defined in the IEEE 754 standard

- For Invalid Operation exceptions, for details of which quiet NaN is produced as the default result see *NaN handling and the Default NaN* on page A2-41.
- For Division by Zero exceptions, the sign bit of the default result is determined normally for a division. This means it is the exclusive OR of the sign bits of the two operands.
- For Overflow exceptions, the sign bit of the default result is determined normally for the overflowing operation.

Combinations of exceptions

The following pseudocode functions perform *floating-point operations*:

```

FixedToFP()
FPAbs()
FPAdd()
FPCompare()
FPCompareGE()
FPCompareGT()
FPDiv()
FPDoubleToSingle()
FPMax()
FPMin()
FPMul()
FPNeg()
FPRecipEstimate()
FPRecipStep()
FPRSqrtEstimate()
FPRSqrtStep()
FPSingleToDouble()
FPSqrt()
FPSub()
FPToFixed()
    
```

All of these operations except `FPAbs()` and `FPNeg()` can generate floating-point exceptions.

More than one exception can occur on the same operation. The only combinations of exceptions that can occur are:

- Overflow with Inexact
- Underflow with Inexact
- Input Denormal with other exceptions.

When none of the exceptions caused by an operation are trapped, any exception that occurs causes the associated cumulative flag in the FPSCR to be set.

When one or more exceptions caused by an operation are trapped, the behavior of the instruction depends on the priority of the exceptions. The Inexact exception is treated as lowest priority, and Input Denormal as highest priority:

- If the higher priority exception is trapped, its trap handler is called. It is IMPLEMENTATION DEFINED whether the parameters to the trap handler include information about the lower priority exception. Apart from this, the lower priority exception is ignored in this case.
- If the higher priority exception is untrapped, its cumulative bit is set to 1 and its default result is evaluated. Then the lower priority exception is handled normally, using this default result.

Some floating-point instructions specify more than one floating-point operation, as indicated by the pseudocode descriptions of the instruction. In such cases, an exception on one operation is treated as higher priority than an exception on another operation if the occurrence of the second exception depends on the result of the first operation. Otherwise, it is UNPREDICTABLE which exception is treated as higher priority.

For example, a `VMLA.F32` instruction specifies a floating-point multiplication followed by a floating-point addition. The addition can generate Overflow, Underflow and Inexact exceptions, all of which depend on both operands to the addition and so are treated as lower priority than any exception on the multiplication. The same applies to Invalid Operation exceptions on the addition caused by adding opposite-signed infinities.

The addition can also generate an Input Denormal exception, caused by the addend being a denormalized number while in Flush-to-zero mode. It is UNPREDICTABLE which of an Input Denormal exception on the addition and an exception on the multiplication is treated as higher priority, because the occurrence of the Input Denormal exception does not depend on the result of the multiplication. The same applies to an Invalid Operation exception on the addition caused by the addend being a signaling NaN.

———— **Note** —————

Like other details of VFP instruction execution, these rules about exception handling apply to the overall results produced by an instruction when the system uses a combination of hardware and support code to implement it. See *VFP support code* on page B1-70 for more information.

These principles also apply to the multiple floating-point operations generated by VFP instructions in the deprecated VFP vector mode of operation. For details of this mode of operation see Appendix F *VFP Vector Operation Support*.

A2.7.8 Pseudocode details of floating-point operations

This section contains pseudocode definitions of the floating-point operations used by the architecture.

Generation of specific floating-point values

The following pseudocode functions generate specific floating-point values. The sign argument of FPInfinity(), FPMaxNormal(), and FPZero() is '0' for the positive version and '1' for the negative version.

```
// FPZero()
// =====

bits(N) FPZero(bit sign, integer N)
    assert N == 16 || N == 32 || N == 64;
    if N == 16 then
        return sign : '00000 0000000000';
    elsif N == 32 then
        return sign : '00000000 000000000000000000000000';
    else
        return sign : '0000000000 00000000000000000000000000000000000000000000000000000';

// FPTwo()
// =====

bits(N) FPTwo(integer N)
    assert N == 32 || N == 64;
    if N == 32 then
        return '0 10000000 000000000000000000000000';
    else
        return '0 10000000000 00000000000000000000000000000000000000000000000000000000';

// FPThree()
// =====

bits(N) FPThree(integer N)
    assert N == 32 || N == 64;
    if N == 32 then
        return '0 10000000 100000000000000000000000';
    else
        return '0 10000000000 10000000000000000000000000000000000000000000000000000000';

// FPMaxNormal()
// =====

bits(N) FPMaxNormal(bit sign, integer N)
    assert N == 16 || N == 32 || N == 64;
    if N == 16 then
        return sign : '11110 111111111';
    elsif N == 32 then
        return sign : '11111110 111111111111111111111111';
    else
        return sign : '1111111110 1111111111111111111111111111111111111111111111111111111';
```

```

// FPInfinity()
// =====

bits(N) FPInfinity(bit sign, integer N)
    assert N == 16 || N == 32 || N == 64;
    if N == 16 then
        return sign : '11111 0000000000';
    elseif N == 32 then
        return sign : '11111111 0000000000000000000000';
    else
        return sign : '1111111111 000000000000000000000000000000000000000000000000';

// FPDefaultNaN()
// =====

bits(N) FPDefaultNaN(integer N)
    assert N == 16 || N == 32 || N == 64;
    if N == 16 then
        return '0 11111 1000000000';
    elseif N == 32 then
        return '0 11111111 1000000000000000000000';
    else
        return '0 1111111111 100000000000000000000000000000000000000000000000';

```

Note

This definition of FPDefaultNaN() applies to VFPv3 and VFPv3U. For VFPv2, the sign bit of the result is a single-bit UNKNOWN value, instead of 0.

Negation and absolute value

The floating-point negation and absolute value operations only affect the sign bit. They do not treat NaN operands specially, nor denormalized number operands when flush-to-zero is selected.

```

// FPNeg()
// =====

bits(N) FPNeg(bits(N) operand)
    assert N == 32 || N == 64;
    return NOT(operand<N-1>) : operand<N-2:0>;

// FPAbs()
// =====

bits(N) FPAbs(bits(N) operand)
    assert N == 32 || N == 64;
    return '0' : operand<N-2:0>;

```

Floating-point value unpacking

The FPUunpack() function determines the type and numerical value of a floating-point number. It also does flush-to-zero processing on input operands.

```
enumeration FPType {FPType_Nonzero, FPType_Zero, FPType_Infinity, FPType_QNaN, FPType_SNaN};
```

```
// FPUunpack()
// =====
//
// Unpack a floating-point number into its type, sign bit and the real number
// that it represents. The real number result has the correct sign for numbers
// and infinities, is very large in magnitude for infinities, and is 0.0 for
// NaNs. (These values are chosen to simplify the description of comparisons
// and conversions.)
//
// The 'fpscr_val' argument supplies FPSCR control bits. Status information is
// updated directly in the FPSCR where appropriate.

(FPType, bit, real) FPUunpack(bits(N) fpval, bits(32) fpscr_val)
    assert N == 16 || N == 32 || N == 64;

    if N == 16 then
        sign = fpval<15>;
        exp = fpval<14:10>;
        frac = fpval<9:0>;
        if IsZero(exp) then
            // Produce zero if value is zero
            if IsZero(frac) then
                type = FPType_Zero; value = 0.0;
            else
                type = FPType_Nonzero; value = 2-14 * (UInt(frac) * 2-10);
        elsif IsOnes(exp) && fpscr_val<26> == '0' then // Infinity or NaN in IEEE format
            if IsZero(frac) then
                type = FPType_Infinity; value = 21000000;
            else
                type = if frac<9> == '1' then FPType_QNaN else FPType_SNaN;
                value = 0.0;
        else
            type = FPType_Nonzero; value = 2UInt(exp)-15 * (1.0 + UInt(frac) * 2-10);

    elsif N == 32 then

        sign = fpval<31>;
        exp = fpval<30:23>;
        frac = fpval<22:0>;
        if IsZero(exp) then
            // Produce zero if value is zero or flush-to-zero is selected.
            if IsZero(frac) || fpscr_val<24> == '1' then
                type = FPType_Zero; value = 0.0;
                if !IsZero(frac) then // Denormalized input flushed to zero
                    FPProcessException(FPExc_InputDenorm, fpscr_val);
            else
                type = FPType_Nonzero; value = 2-126 * (UInt(frac) * 2-23);
```



```

elseif IsOnes(exp) then
  if IsZero(frac) then
    type = FPType_Infinity; value = 2^1000000;
  else
    type = if frac<22> == '1' then FPType_QNaN else FPType_SNaN;
    value = 0.0;
  else
    type = FPType_Nonzero; value = 2^(UInt(exp)-127) * (1.0 + UInt(frac) * 2^-23));
else // N == 64

sign = fpval<63>;
exp = fpval<62:52>;
frac = fpval<51:0>;
if IsZero(exp) then
  // Produce zero if value is zero or flush-to-zero is selected.
  if IsZero(frac) || fpscr_val<24> == '1' then
    type = FPType_Zero; value = 0.0;
    if !IsZero(frac) then // Denormalized input flushed to zero
      FPProcessException(FPExc_InputDenorm, fpscr_val);
  else
    type = FPType_Nonzero; value = 2^-1022 * (UInt(frac) * 2^-52);
elseif IsOnes(exp) then
  if IsZero(frac) then
    type = FPType_Infinity; value = 2^1000000;
  else
    type = if frac<51> == '1' then FPType_QNaN else FPType_SNaN;
    value = 0.0;
else
  type = FPType_Nonzero; value = 2^(UInt(exp)-1023) * (1.0 + UInt(frac) * 2^-52));

if sign == '1' then value = -value;
return (type, sign, value);

```

Floating-point exception and NaN handling

The `FPProcessException()` procedure checks whether a floating-point exception is trapped, and handles it accordingly:

```

enumeration FPExc (FPExc_InvalidOp, FPExc_DivideByZero, FPExc_Overflow,
                  FPExc_Underflow, FPExc_Inexact, FPExc_InputDenorm);

// FPProcessException()
// =====
//
// The 'fpscr_val' argument supplies FPSCR control bits. Status information is
// updated directly in the FPSCR where appropriate.

FPProcessException(FPExc exception, bits(32) fpscr_val)
// Get appropriate FPSCR bit numbers
case exception of
  when FPExc_InvalidOp   enable = 8;   cumul = 0;
  when FPExc_DivideByZero enable = 9;   cumul = 1;

```

```

        when FPExc_Overflow      enable = 10; cumul = 2;
        when FPExc_Underflow    enable = 11; cumul = 3;
        when FPExc_Inexact      enable = 12; cumul = 4;
        when FPExc_InputDenorm  enable = 15; cumul = 7;
    if fpscr_val<enable> then
        IMPLEMENTATION_DEFINED floating-point trap handling;
    else
        FPSCR<cumul> = '1';
    return;

```

The FPPProcessNaN() function processes a NaN operand, producing the correct result value and generating an Invalid Operation exception if necessary:

```

// FPPProcessNaN()
// =====
//
// The 'fpscr_val' argument supplies FPSCR control bits. Status information is
// updated directly in the FPSCR where appropriate.

bits(N) FPPProcessNaN(FPType type, bits(N) operand, bits(32) fpscr_val)
    assert N == 32 || N == 64;
    topfrac = if N == 32 then 22 else 51;
    result = operand;
    if type = FPType_SNaN then
        result<topfrac> = '1';
        FPPProcessException(FPExc_InvalidOp, fpscr_val);
    if fpscr_val<25> == '1' then // DefaultNaN requested
        result = FPDefaultNaN(N);
    return result;

```

The FPPProcessNaNs() function performs the standard NaN processing for a two-operand operation:

```

// FPPProcessNaNs()
// =====
//
// The boolean part of the return value says whether a NaN has been found and
// processed. The bits(N) part is only relevant if it has and supplies the
// result of the operation.
//
// The 'fpscr_val' argument supplies FPSCR control bits. Status information is
// updated directly in the FPSCR where appropriate.

(boolean, bits(N)) FPPProcessNaNs(FPType type1, FPType type2,
                                bits(N) op1, bits(N) op2,
                                bits(32) fpscr_val)
    assert N == 32 || N == 64;
    if type1 == FPType_SNaN then
        done = TRUE; result = FPPProcessNaN(type1, op1, fpscr_val);
    elsif type2 == FPType_SNaN then
        done = TRUE; result = FPPProcessNaN(type2, op2, fpscr_val);
    elsif type1 == FPType_QNaN then
        done = TRUE; result = FPPProcessNaN(type1, op1, fpscr_val);
    elsif type2 == FPType_QNaN then
        done = TRUE; result = FPPProcessNaN(type2, op2, fpscr_val);

```

```

else
    done = FALSE; result = Zeros(N); // 'Don't care' result
return (done, result);

```

Floating-point rounding

The `FPRound()` function rounds and encodes a floating-point result value to a specified destination format. This includes processing Overflow, Underflow and Inexact floating-point exceptions and performing flush-to-zero processing on result values.

```

// FPRound()
// =====
//
// The 'fpSCR_val' argument supplies FPSCR control bits. Status information is
// updated directly in the FPSCR where appropriate.

bits(N) FPRound(real result, integer N, bits(32) fpSCR_val)
    assert N == 16 || N == 32 || N == 64;
    assert result != 0.0;

    // Obtain format parameters - minimum exponent, numbers of exponent and fraction bits.
    if N == 16 then
        minimum_exp = -14; E = 5; F = 10;
    elseif N == 32 then
        minimum_exp = -126; E = 8; F = 23;
    else // N == 64
        minimum_exp = -1022; E = 11; F = 52;

    // Split value into sign, unrounded mantissa and exponent.
    if result < 0.0 then
        sign = '1'; mantissa = -result;
    else
        sign = '0'; mantissa = result;
    exponent = 0;
    while mantissa < 1.0 do
        mantissa = mantissa * 2.0; exponent = exponent - 1;
    while mantissa >= 2.0 do
        mantissa = mantissa / 2.0; exponent = exponent + 1;

    // Deal with flush-to-zero.
    if fpSCR_val < 24 > == '1' && N != 16 && exponent < minimum_exp then
        result = FPZero(sign, N);
        FPSCR.UFC = '1'; // Flush-to-zero never generates a trapped exception
    else

        // Start creating the exponent value for the result. Start by biasing the actual exponent
        // so that the minimum exponent becomes 1, lower values 0 (indicating possible underflow).
        biased_exp = Max(exponent - minimum_exp + 1, 0);
        if biased_exp == 0 then mantissa = mantissa / 2^(minimum_exp - exponent);

        // Get the unrounded mantissa as an integer, and the "units in last place" rounding error.
        int_mant = RoundDown(mantissa * 2^F); // < 2^F if biased_exp == 0, >= 2^F if not
        error = mantissa * 2^F - int_mant;

```

```

// Underflow occurs if exponent is too small before rounding, and result is inexact or
// the Underflow exception is trapped.
if biased_exp == 0 && (error != 0.0 || fpscr_val<11> == '1') then
    FPProcessException(FPExc_Underflow, fpscr_val);

// Round result according to rounding mode.
case fpscr_val<23:22> of
    when '00' // Round to Nearest (rounding to even if exactly halfway)
        round_up = (error > 0.5 || (error == 0.5 && int_mant<0> == '1'));
        overflow_to_inf = TRUE;
    when '01' // Round towards Plus Infinity
        round_up = (error != 0.0 && sign == '0');
        overflow_to_inf = (sign == '0');
    when '10' // Round towards Minus Infinity
        round_up = (error != 0.0 && sign == '1');
        overflow_to_inf = (sign == '1');
    when '11' // Round towards Zero
        round_up = FALSE;
        overflow_to_inf = FALSE;
if round_up then
    int_mant = int_mant + 1;
    if int_mant == 2^F then // Rounded up from denormalized to normalized
        biased_exp = 1;
    if int_mant == 2^(F+1) then // Rounded up to next exponent
        biased_exp = biased_exp + 1; int_mant = int_mant DIV 2;

// Deal with overflow and generate result.
if N != 16 || fpscr_val<26> == '0' then // Single, double or IEEE half precision
    if biased_exp >= 2^E - 1 then
        result = if overflow_to_inf then FPInfinity(sign, N) else FPMaxNormal(sign, N);
        FPProcessException(FPExc_Overflow, fpscr_val);
    else
        result = sign : biased_exp<E-1:0> : int_mant<F-1:0>;
else // Alternative half precision
    if biased_exp >= 2^E then
        result = sign : Ones(15);
        FPProcessException(FPExc_InvalidOp, fpscr_val);
        error = 0.0; // avoid an Inexact exception
    else
        result = sign : biased_exp<E-1:0> : int_mant<F-1:0>;

// Deal with Inexact exception.
if error != 0 then
    FPProcessException(FPExc_Inexact, fpscr_val);

return result;

```

Selection of ARM standard floating-point arithmetic

StandardFPSCRValue is an FPSCR value that selects ARM standard floating-point arithmetic. Most of the arithmetic functions have a boolean fpscr_controlled argument that is TRUE for VFP operations and FALSE for Advanced SIMD operations, and that selects between using the real FPSCR value and this value.

```
// StandardFPSCRValue()
// =====

bits(32) StandardFPSCRValue()
    return '00000' : FPSCR<26> : '110000000000000000000000';
```

Comparisons

The FPCompare() function compares two floating-point numbers, producing an (N,Z,C,V) flags result as shown in Table A2-8:

Table A2-8 VFP comparison flag values

Comparison result	N	Z	C	V
Equal	0	1	1	0
Less than	1	0	0	0
Greater than	0	0	1	0
Unordered	0	0	1	1

This result is used to define the VCMPI instruction in the VFP extension. The VCMPI instruction writes these flag values in the FPSCR. After using a VMRS instruction to transfer them to the APSR, they can be used to control conditional execution as shown in Table A8-1 on page A8-8.

```
// FPCompare()
// =====

(bit, bit, bit, bit) FPCompare(bits(N) op1, bits(N) op2, boolean quiet_nan_exc,
    boolean fpscr_controlled)
    assert N == 32 || N == 64;
    fpscr_val = if fpscr_controlled then FPSCR else StandardFPSCRValue();
    (type1,sign1,value1) = FPUunpack(op1, fpscr_val);
    (type2,sign2,value2) = FPUunpack(op2, fpscr_val);
    if type1==FPTYPE_SNaN || type1==FPTYPE_QNaN || type2==FPTYPE_SNaN || type2==FPTYPE_QNaN then
        result = ('0','0','1','1');
        if type1==FPTYPE_SNaN || type2==FPTYPE_SNaN || quiet_nan_exc then
            FPPROCESSException(FPEXC_InvalidOp, fpscr_val);
    else
        // All non-NaN cases can be evaluated on the values produced by FPUunpack()
        if value1 == value2 then
            result = ('0','1','1','0');
        elseif value1 < value2 then
            result = ('1','0','0','0');
        else // value1 > value2
            result = ('0','0','1','0');
    return result;
```

The FPCompareEQ(), FPCompareGE() and FPCompareGT() functions are used to describe Advanced SIMD instructions that perform floating-point comparisons.

```
// FPCompareEQ()
// =====

boolean FPCompareEQ(bits(32) op1, bits(32) op2, boolean fpscr_controlled)
    fpscr_val = if fpscr_controlled then FPSCR else StandardFPSCRValue();
    (type1,sign1,value1) = FPUnpack(op1, fpscr_val);
    (type2,sign2,value2) = FPUnpack(op2, fpscr_val);
    if type1==FPTType_SNaN || type1==FPTType_QNaN || type2==FPTType_SNaN || type2==FPTType_QNaN then
        result = FALSE;
        if type1==FPTType_SNaN || type2==FPTType_SNaN then
            FPProcessException(FPExc_InvalidOp, fpscr_val);
    else
        // All non-NaN cases can be evaluated on the values produced by FPUnpack()
        result = (value1 == value2);
    return result;

// FPCompareGE()
// =====

boolean FPCompareGE(bits(32) op1, bits(32) op2, boolean fpscr_controlled)
    fpscr_val = if fpscr_controlled then FPSCR else StandardFPSCRValue();
    (type1,sign1,value1) = FPUnpack(op1, fpscr_val);
    (type2,sign2,value2) = FPUnpack(op2, fpscr_val);
    if type1==FPTType_SNaN || type1==FPTType_QNaN || type2==FPTType_SNaN || type2==FPTType_QNaN then
        result = FALSE;
        FPProcessException(FPExc_InvalidOp, fpscr_val);
    else
        // All non-NaN cases can be evaluated on the values produced by FPUnpack()
        result = (value1 >= value2);
    return result;

// FPCompareGT()
// =====

boolean FPCompareGT(bits(32) op1, bits(32) op2, boolean fpscr_controlled)
    fpscr_val = if fpscr_controlled then FPSCR else StandardFPSCRValue();
    (type1,sign1,value1) = FPUnpack(op1, fpscr_val);
    (type2,sign2,value2) = FPUnpack(op2, fpscr_val);
    if type1==FPTType_SNaN || type1==FPTType_QNaN || type2==FPTType_SNaN || type2==FPTType_QNaN then
        result = FALSE;
        FPProcessException(FPExc_InvalidOp, fpscr_val);
    else
        // All non-NaN cases can be evaluated on the values produced by FPUnpack()
        result = (value1 > value2);
    return result;
```

Maximum and minimum

```

// FPMaX()
// =====

bits(N) FPMaX(bits(N) op1, bits(N) op2, boolean fpscr_controlled)
    assert N == 32 || N == 64;
    fpscr_val = if fpscr_controlled then FPSCR else StandardFPSCRValue();
    (type1,sign1,value1) = FPUnpack(op1, fpscr_val);
    (type2,sign2,value2) = FPUnpack(op2, fpscr_val);
    (done,result) = FPProcessNaNs(type1, type2, op1, op2, fpscr_val);
    if !done then
        if type1 == FPType_Zero && type2 == FPType_Zero && sign1 == NOT(sign2) then
            // Opposite-signed zeros produce +0.0
            result = FPZero('0', N);
        else
            // All other cases can be evaluated on the values produced by FPUnpack()
            result = if value1 > value2 then op1 else op2;
    return result;

// FPMiN()
// =====

bits(N) FPMiN(bits(N) op1, bits(N) op2, boolean fpscr_controlled)
    assert N == 32 || N == 64;
    fpscr_val = if fpscr_controlled then FPSCR else StandardFPSCRValue();
    (type1,sign1,value1) = FPUnpack(op1, fpscr_val);
    (type2,sign2,value2) = FPUnpack(op2, fpscr_val);
    (done,result) = FPProcessNaNs(type1, type2, op1, op2, fpscr_val);
    if !done then
        if type1 == FPType_Zero && type2 == FPType_Zero && sign1 == NOT(sign2) then
            // Opposite-signed zeros produce -0.0
            result = FPZero('1', N);
        else
            // All other cases can be evaluated on the values produced by FPUnpack()
            result = if value1 < value2 then op1 else op2;
    return result;

```

Addition and subtraction

```

// FPAdd()
// =====

bits(N) FPAdd(bits(N) op1, bits(N) op2, boolean fpscr_controlled)
    assert N == 32 || N == 64;
    fpscr_val = if fpscr_controlled then FPSCR else StandardFPSCRValue();
    (type1,sign1,value1) = FPUnpack(op1, fpscr_val);
    (type2,sign2,value2) = FPUnpack(op2, fpscr_val);
    (done,result) = FPProcessNaNs(type1, type2, op1, op2, fpscr_val);
    if !done then
        inf1 = (type1 == FPType_Infinity);  inf2 = (type2 == FPType_Infinity);
        zero1 = (type1 == FPType_Zero);     zero2 = (type2 == FPType_Zero);
        if inf1 && inf2 && sign1 == NOT(sign2) then

```

```

        result = FPDefaultNaN(N);
        FPProcessException(FPExc_InvalidOp, fpscr_val);
    elseif (inf1 && sign1 == '0') || (inf2 && sign2 == '0') then
        result = FPInfinity('0', N);
    elseif (inf1 && sign1 == '1') || (inf2 && sign2 == '1') then
        result = FPInfinity('1', N);
    elseif zero1 && zero2 && sign1 == sign2 then
        result = FPZero(sign1, N);
    else
        result_value = value1 + value2;
        if result_value == 0.0 then // Sign of exact zero result depends on rounding mode
            result_sign = if fpscr_val<23:22> == '10' then '1' else '0';
            result = FPZero(result_sign, N);
        else
            result = FPRound(result_value, N, fpscr_val);
    return result;

// FSub()
// =====

bits(N) FSub(bits(N) op1, bits(N) op2, boolean fpscr_controlled)
    assert N == 32 || N == 64;
    fpscr_val = if fpscr_controlled then FPSCR else StandardFPSCRValue();
    (type1,sign1,value1) = FPUnpack(op1, fpscr_val);
    (type2,sign2,value2) = FPUnpack(op2, fpscr_val);
    (done,result) = FPProcessNaNs(type1, type2, op1, op2, fpscr_val);
    if !done then
        inf1 = (type1 == FPType_Infinity);  inf2 = (type2 == FPType_Infinity);
        zero1 = (type1 == FPType_Zero);      zero2 = (type2 == FPType_Zero);
        if inf1 && inf2 && sign1 == sign2 then
            result = FPDefaultNaN(N);
            FPProcessException(FPExc_InvalidOp, fpscr_val);
        elseif (inf1 && sign1 == '0') || (inf2 && sign2 == '1') then
            result = FPInfinity('0', N);
        elseif (inf1 && sign1 == '1') || (inf2 && sign2 == '0') then
            result = FPInfinity('1', N);
        elseif zero1 && zero2 && sign1 == NOT(sign2) then
            result = FPZero(sign1, N);
        else
            result_value = value1 - value2;
            if result_value == 0.0 then // Sign of exact zero result depends on rounding mode
                result_sign = if fpscr_val<23:22> == '10' then '1' else '0';
                result = FPZero(result_sign, N);
            else
                result = FPRound(result_value, N, fpscr_val);
    return result;

```

Multiplication and division

```

// FPMul()
// =====

bits(N) FPMul(bits(N) op1, bits(N) op2, boolean fpscr_controlled)
    assert N == 32 || N == 64;
    fpscr_val = if fpscr_controlled then FPSCR else StandardFPSCRValue();
    (type1,sign1,value1) = FPUunpack(op1, fpscr_val);
    (type2,sign2,value2) = FPUunpack(op2, fpscr_val);
    (done,result) = FPPProcessNaNs(type1, type2, op1, op2, fpscr_val);
    if !done then
        inf1 = (type1 == FPType_Infinity); inf2 = (type2 == FPType_Infinity);
        zero1 = (type1 == FPType_Zero); zero2 = (type2 == FPType_Zero);
        if (inf1 && zero2) || (zero1 && inf2) then
            result = FPDefaultNaN(N);
            FPPProcessException(FPExc_InvalidOp, fpscr_val);
        elsif inf1 || inf2 then
            result_sign = if sign1 == sign2 then '0' else '1';
            result = FPIfinity(result_sign, N);
        elsif zero1 || zero2 then
            result_sign = if sign1 == sign2 then '0' else '1';
            result = FPZero(result_sign, N);
        else
            result = FPRound(value1*value2, N, fpscr_val);
    return result;

// FPDiv()
// =====

bits(N) FPDiv(bits(N) op1, bits(N) op2, boolean fpscr_controlled)
    assert N == 32 || N == 64;
    fpscr_val = if fpscr_controlled then FPSCR else StandardFPSCRValue();
    (type1,sign1,value1) = FPUunpack(op1, fpscr_val);
    (type2,sign2,value2) = FPUunpack(op2, fpscr_val);
    (done,result) = FPPProcessNaNs(type1, type2, op1, op2, fpscr_val);
    if !done then
        inf1 = (type1 == FPType_Infinity); inf2 = (type2 == FPType_Infinity);
        zero1 = (type1 == FPType_Zero); zero2 = (type2 == FPType_Zero);
        if (inf1 && inf2) || (zero1 && zero2) then
            result = FPDefaultNaN(N);
            FPPProcessException(FPExc_InvalidOp, fpscr_val);
        elsif inf1 || zero2 then
            result_sign = if sign1 == sign2 then '0' else '1';
            result = FPIfinity(result_sign, N);
            if !inf1 then FPPProcessException(FPExc_DivideByZero);
        elsif zero1 || inf2 then
            result_sign = if sign1 == sign2 then '0' else '1';
            result = FPZero(result_sign, N);
        else
            result = FPRound(value1/value2, N, fpscr_val);
    return result;

```

Reciprocal estimate and step

The Advanced SIMD extension includes instructions that support Newton-Raphson calculation of the reciprocal of a number.

The VRECPE instruction produces the initial estimate of the reciprocal. It uses the following pseudocode functions:

```
// FPrecipEstimate()
// =====

bits(32) FPrecipEstimate(bits(32) operand)

    (type,sign,value) = FPUnpack(operand, StandardFPSCRValue());
    if type == FType_SNaN || type == FType_QNaN then
        result = FProcessNaN(type, operand, StandardFPSCRValue());
    elseif type == FType_Infinity then
        result = FPZero(sign, 32);
    elseif type == FType_Zero then
        result = FPinfinity(sign, 32);
        FProcessException(FPExc_DivideByZero, StandardFPSCRValue());
    elseif Abs(value) >= 2^126 then // Result underflows to zero of correct sign
        result = FPZero(sign, 32);
        FProcessException(FPExc_Underflow, StandardFPSCRValue());;
    else
        // Operand must be normalized, since denormalized numbers are flushed to zero. Scale to a
        // double-precision value in the range 0.5 <= x < 1.0, and calculate result exponent.
        // Scaled value has copied sign bit, exponent = 1022 = double-precision biased version of
        // -1, fraction = original fraction extended with zeros.
        scaled = operand<31> : '0111111110' : operand<22:0> : Zeros(29);
        result_exp = 253 - UInt(operand<30:23>); // In range 253-252 = 1 to 253-1 = 252

        // Call C function to get reciprocal estimate of scaled value.
        estimate = recip_estimate(scaled);

        // Result is double-precision and a multiple of 1/256 in the range 1 to 511/256. Convert
        // to scaled single-precision result with copied sign bit and high-order fraction bits,
        // and exponent calculated above.
        result = estimate<63> : result_exp<7:0> : estimate<51:29>;

    return result;

// UnsignedRecipEstimate()
// =====

bits(32) UnsignedRecipEstimate(bits(32) operand)

    if operand<31> == '0' then // Operands <= 0x7FFFFFFF produce 0xFFFFFFFF
        result = Ones(32);
    else
        // Generate double-precision value = operand * 2^(-32). This has zero sign bit,
        // exponent = 1022 = double-precision biased version of -1, fraction taken from
        // operand, excluding its most significant bit.
        dp_operand = '0 0111111110' : operand<30:0> : Zeros(21);
```



```

// Call C function to get reciprocal estimate of scaled value.
estimate = recip_estimate(dp_operand);

// Result is double-precision and a multiple of 1/256 in the range 1 to 511/256.
// Multiply by 2^31 and convert to an unsigned integer - this just involves
// concatenating the implicit units bit with the top 31 fraction bits.
result = '1' : estimate<51:21>;

return result;

```

where recip_estimate() is defined by the following C function:

```

double recip_estimate(double a)
{
    int q, s;
    double r;
    q = (int)(a * 512.0);          /* a in units of 1/512 rounded down */
    r = 1.0 / (((double)q + 0.5) / 512.0); /* reciprocal r */
    s = (int)(256.0 * r + 0.5);    /* r in units of 1/256 rounded to nearest */
    return (double)s / 256.0;
}

```

Table A2-9 shows the results where input values are out of range.

Table A2-9 VRECPE results for out-of-range inputs

Number type	Input Vm[i]	Result Vd[i]
Integer	$\leq 0x7FFFFFFF$	0xFFFFFFFF
Floating-point	NaN	Default NaN
Floating-point	+/- 0 or denormalized number	+/- Infinity ^a
Floating-point	+/- infinity	+/- 0
Floating-point	Absolute value $\geq 2^{126}$	+/- 0

a. The Division by Zero exception bit in the FPSCR (FPSCR[1]) is set

The Newton-Raphson iteration:

$$x_{n+1} = x_n(2 - dx_n)$$

converges to $(1/d)$ if x_0 is the result of VRECPE applied to d .

The VRECPS instruction performs a $2 - op1 * op2$ calculation and can be used with a multiplication to perform a step of this iteration. The functionality of this instruction is defined by the following pseudocode function:

```

// FPrecipStep()
// =====

```

```

bits(32) FPRecipStep(bits(32) op1, bits(32) op2)
    (type1,sign1,value1) = FPUnpack(op1, StandardFPSCRValue());
    (type2,sign2,value2) = FPUnpack(op2, StandardFPSCRValue());
    (done,result) = FPProcessNaNs(type1, type2, op1, op2, StandardFPSCRValue());
    if !done then
        inf1 = (type1 == FPType_Infinity);  inf2 = (type2 == FPType_Infinity);
        zero1 = (type1 == FPType_Zero);    zero2 = (type2 == FPType_Zero);
        if (inf1 && zero2) || (zero1 && inf2) then
            product = FPZero('0', 32);
        else
            product = FPMul(op1, op2, FALSE);
            result = FPSub(FPTwo(32), product, FALSE);
    return result;

```

Table A2-10 shows the results where input values are out of range.

Table A2-10 VRECPS results for out-of-range inputs

Input Vn[i]	Input Vm[i]	Result Vd[i]
Any NaN	-	Default NaN
-	Any NaN	Default NaN
+/- 0.0 or denormalized number	+/- infinity	2.0
+/- infinity	+/- 0.0 or denormalized number	2.0

Square root

```

// FPSqrt()
// =====

```

```

bits(N) FPSqrt(bits(N) operand, boolean fpscr_controlled)
    assert N == 32 || N == 64;
    fpscr_val = if fpscr_controlled then FPSCR else StandardFPSCRValue();
    (type,sign,value) = FPUnpack(operand, fpscr_val);
    if type == FPType_SNaN || type == FPType_QNaN then
        result = FPProcessNaN(type, operand, fpscr_val);
    elsif type == FPType_Zero || (type = FPType_Infinity && sign == '0') then
        result = operand;
    elsif sign == '1' then
        result = FPDefaultNaN(N);
        FPProcessException(FPExc_InvalidOp, fpscr_val);
    else
        result = FPRound(Sqrt(value), N, fpscr_val);
    return result;

```

Reciprocal square root

The Advanced SIMD extension includes instructions that support Newton-Raphson calculation of the reciprocal of the square root of a number.

The VRSQRTE instruction produces the initial estimate of the reciprocal of the square root. It uses the following pseudocode functions:

```
// FPRSqrtEstimate()
// =====

bits(32) FPRSqrtEstimate(bits(32) operand)

    (type,sign,value) = FPUnpack(operand, StandardFPSCRValue());
    if type == FPType_SNaN || type == FPType_QNaN then
        result = FPProcessNaN(type, operand, StandardFPSCRValue());
    elseif type == FPType_Zero then
        result = FPInfinity(sign, 32);
        FPProcessException(FPExc_DivideByZero, StandardFPSCRValue());
    elseif sign == '1' then
        result = FPDefaultNaN(32);
        FPProcessException(FPExc_InvalidOp, StandardFPSCRValue());
    elseif type == FPType_Infinity then
        result = FPZero('0', 32);
    else
        // Operand must be normalized, since denormalized numbers are flushed to zero. Scale to a
        // double-precision value in the range 0.25 <= x < 1.0, with the evenness or oddness of
        // the exponent unchanged, and calculate result exponent. Scaled value has copied sign
        // bit, exponent = 1022 or 1021 = double-precision biased version of -1 or -2, fraction
        // = original fraction extended with zeros.
        if operand<23> == '0' then
            scaled = operand<31> : '0111111110' : operand<22:0> : Zeros(29);
        else
            scaled = operand<31> : '01111111101' : operand<22:0> : Zeros(29);
            result_exp = (380 - UInt(operand<30:23>)) DIV 2;

        // Call C function to get reciprocal estimate of scaled value.
        estimate = recip_sqrt_estimate(scaled);

        // Result is double-precision and a multiple of 1/256 in the range 1 to 511/256. Convert
        // to scaled single-precision result with copied sign bit and high-order fraction bits,
        // and exponent calculated above.
        result = estimate<63> : result_exp<7:0> : estimate<51:29>;

    return result;

// UnsignedRSqrtEstimate()
// =====

bits(32) UnsignedRSqrtEstimate(bits(32) operand)

    if operand<31:30> == '00' then // Operands <= 0x3FFFFFF produce 0xFFFFFFFF
        result = Ones(32);
    else
```

```

// Generate double-precision value = operand * 2-32. This has zero sign bit,
// exponent = 1022 or 1021 = double-precision biased version of -1 or -2,
// fraction taken from operand, excluding its most significant one or two bits.
if operand<31> == '1' then
    dp_operand = '0 01111111110' : operand<30:0> : Zeros(21);
else // operand<31:30> == '01'
    dp_operand = '0 01111111101' : operand<29:0> : Zeros(22);

// Call C function to get reciprocal estimate of scaled value.
estimate = recip_sqrt_estimate(dp_operand);

// Result is double-precision and a multiple of 1/256 in the range 1 to 511/256.
// Multiply by 231 and convert to an unsigned integer - this just involves
// concatenating the implicit units bit with the top 31 fraction bits.
result = '1' : estimate<51:21>;

return result;

```

where recip_sqrt_estimate() is defined by the following C function:

```

double recip_sqrt_estimate(double a)
{
    int q0, q1, s;
    double r;
    if (a < 0.5) /* range 0.25 <= a < 0.5 */
    {
        q0 = (int)(a * 512.0); /* a in units of 1/512 rounded down */
        r = 1.0 / sqrt(((double)q0 + 0.5) / 512.0); /* reciprocal root r */
    }
    else /* range 0.5 <= a < 1.0 */
    {
        q1 = (int)(a * 256.0); /* a in units of 1/256 rounded down */
        r = 1.0 / sqrt(((double)q1 + 0.5) / 256.0); /* reciprocal root r */
    }
    s = (int)(256.0 * r + 0.5); /* r in units of 1/256 rounded to nearest */
    return (double)s / 256.0;
}

```

Table A2-11 shows the results where input values are out of range.

Table A2-11 VRSQRTE results for out-of-range inputs

Number type	Input Vm[i]	Result Vd[i]
Integer	<= 0x3FFFFFFF	0xFFFFFFFF
Floating-point	NaN, – normalized number, – infinity	Default NaN
Floating-point	– 0 or – denormalized number	– infinity ^a
Floating-point	+ 0 or + denormalized number	+ infinity ^a
Floating-point	+ infinity	+ 0

- a. The Division by Zero exception bit in the FPSCR (FPSCR[1]) is set.

The Newton-Raphson iteration:

$$x_{n+1} = x_n(3-dx_n^2)/2$$

converges to $(1/\sqrt{d})$ if x_0 is the result of VRSQRTE applied to d .

The VRSQRTS instruction performs a $(3 - op1*op2)/2$ calculation and can be used with two multiplications to perform a step of this iteration. The functionality of this instruction is defined by the following pseudocode function:

```
// FPRSqrtStep()
// =====

bits(32) FPRSqrtStep(bits(32) op1, bits(32) op2)
    (type1,sign1,value1) = FPUnpack(op1, StandardFPSCRValue());
    (type2,sign2,value2) = FPUnpack(op2, StandardFPSCRValue());
    (done,result) = FPPProcessNaNs(type1, type2, op1, op2, StandardFPSCRValue());
    if !done then
        inf1 = (type1 == FPType_Infinity); inf2 = (type2 == FPType_Infinity);
        zero1 = (type1 == FPType_Zero); zero2 = (type2 == FPType_Zero);
        if (inf1 && zero2) || (zero1 && inf2) then
            product = FPZero('0', 32);
        else
            product = FPMul(op1, op2, FALSE);
        result = FPDIV(FPSub(FPThree(32), product, FALSE), FPTwo(32), FALSE);
    return result;
```

Table A2-12 shows the results where input values are out of range.

Table A2-12 VRSQRTS results for out-of-range inputs

Input Vn[i]	Input Vm[i]	Result Vd[i]
Any NaN	-	Default NaN
-	Any NaN	Default NaN
+/- 0.0 or denormalized number	+/- infinity	1.5
+/- infinity	+/- 0.0 or denormalized number	1.5

Conversions

The following functions perform conversions between half-precision and single-precision floating-point numbers.

```
// FPHalfToSingle()
// =====

bits(32) FPHalfToSingle(bits(16) operand, boolean fpscr_controlled)
    fpscr_val = if fpscr_controlled then FPSCR else StandardFPSCRValue();
    (type,sign,value) = FPUnpack(operand, fpscr_val);
    if type == FPType_SNaN || type == FPType_QNaN then
        if fpscr_val<25> == '1' then // DN bit set
            result = FPDefaultNaN(32);
        else
            result = sign : '11111111 1' : operand<8:0> : Zeros(13);
            if type == FPType_SNaN then
                FPProcessException(FPExc_InvalidOp, fpscr_val);
    elseif type = FPType_Infinity then
        result = FPInfinity(sign, 32);
    elseif type = FPType_Zero then
        result = FPZero(sign, 32);
    else
        result = FPRound(value, 32, fpscr_val); // Rounding will be exact
    return result;

// FPSingleToHalf()
// =====

bits(16) FPSingleToHalf(bits(32) operand, boolean fpscr_controlled)
    fpscr_val = if fpscr_controlled then FPSCR else StandardFPSCRValue();
    (type,sign,value) = FPUnpack(operand, fpscr_val);
    if type == FPType_SNaN || type == FPType_QNaN then
        if fpscr_val<26> == '1' then // AH bit set
            result = FPZero(sign, 16);
        elseif fpscr_val<25> == '1' then // DN bit set
            result = FPDefaultNaN(16);
        else
            result = sign : '11111 1' : operand<21:13>;
            if type == FPType_SNaN || fpscr_val<26> == '1' then
                FPProcessException(FPExc_InvalidOp, fpscr_val);
    elseif type = FPType_Infinity then
        if fpscr_val<26> == '1' then // AH bit set
            result = sign : Ones(15);
            FPProcessException(FPExc_InvalidOp, fpscr_val);
        else
            result = FPInfinity(sign, 16);
    elseif type = FPType_Zero then
        result = FPZero(sign, 16);
    else
        result = FPRound(value, 16, fpscr_val);
    return result;
```

The following functions perform conversions between single-precision and double-precision floating-point numbers.

```
// FPSingleToDouble()
// =====

bits(64) FPSingleToDouble(bits(32) operand, boolean fpscr_controlled)
    fpscr_val = if fpscr_controlled then FPSCR else StandardFPSCRValue();
    (type,sign,value) = FPUnpack(operand, fpscr_val);
    if type == FPType_SNaN || type == FPType_QNaN then
        if fpscr_val<25> == '1' then // DN bit set
            result = FPDefaultNaN(64);
        else
            result = sign : '1111111111 1' : operand<21:0> : Zeros(29);
            if type == FPType_SNaN then
                FPProcessException(FPExc_InvalidOp, fpscr_val);
            elseif type = FPType_Infinity then
                result = FPInfinity(sign, 64);
            elseif type = FPType_Zero then
                result = FPZero(sign, 64);
            else
                result = FPRound(value, 64, fpscr_val); // Rounding will be exact
        return result;

// FPDoubleToSingle()
// =====

bits(32) FPDoubleToSingle(bits(64) operand, boolean fpscr_controlled)
    fpscr_val = if fpscr_controlled then FPSCR else StandardFPSCRValue();
    (type,sign,value) = FPUnpack(operand, fpscr_val);
    if type == FPType_SNaN || type == FPType_QNaN then
        if fpscr_val<25> == '1' then // DN bit set
            result = FPDefaultNaN(32);
        else
            result = sign : '11111111 1' : operand<50:29>;
            if type == FPType_SNaN then
                FPProcessException(FPExc_InvalidOp, fpscr_val);
            elseif type = FPType_Infinity then
                result = FPInfinity(sign, 32);
            elseif type = FPType_Zero then
                result = FPZero(sign, 32);
            else
                result = FPRound(value, 32, fpscr_val);
        return result;
```

The following functions perform conversions between floating-point numbers and integers or fixed-point numbers:

```
// FPToFixed()
// =====

bits(M) FPToFixed(bits(N) operand, integer M, integer fraction_bits, boolean unsigned,
    boolean round_towards_zero, boolean fpscr_controlled)
    assert N == 32 || N == 64;
    fpscr_val = if fpscr_controlled then FPSCR else StandardFPSCRValue();
```

```

if round_towards_zero then fpscr_val<23:22> = '11';
(type,sign,value) = FPUnpack(operand, fpscr_val);

// For NaNs and infinities, FPUnpack() has produced a value that will round to the
// required result of the conversion. Also, the value produced for infinities will
// cause the conversion to overflow and signal an Invalid Operation floating-point
// exception as required. NaNs must also generate such a floating-point exception.
if type == FPType_SNaN || type == FPType_QNaN then
    FPProcessException(FPExc_InvalidOp, fpscr_val);

// Scale value by specified number of fraction bits, then start rounding to an integer
// and determine the rounding error.
value = value * 2^fraction_bits;
int_result = RoundDown(value);
error = value - int_result;

// Apply the specified rounding mode.
case fpscr_val<23:22> of
    when '00' // Round to Nearest (rounding to even if exactly halfway)
        round_up = (error > 0.5 || (error == 0.5 && int_result<0> == '1'));
    when '01' // Round towards Plus Infinity
        round_up = (error != 0.0);
    when '10' // Round towards Minus Infinity
        round_up = FALSE;
    when '11' // Round towards Zero
        round_up = (error != 0.0 && int_result < 0);
if round_up then int_result = int_result + 1;

// Bitstring result is the integer result saturated to the destination size, with
// saturation indicating overflow of the conversion (signaled as an Invalid
// Operation floating-point exception).
(result, overflow) = SatQ(int_result, M, unsigned);
if overflow then
    FPProcessException(FPExc_InvalidOp, fpscr_val);
elseif error != 0 then
    FPProcessException(FPExc_Inexact, fpscr_val);

return result;

// FixedToFP()
// =====

bits(N) FixedToFP(bits(M) operand, integer N, integer fraction_bits, boolean unsigned,
    boolean round_to_nearest, boolean fpscr_controlled)
assert N == 32 || N == 64;
fpscr_val = if fpscr_controlled then FPSCR else StandardFPSCRValue();
if round_to_nearest then fpscr_val<23:22> = '00';
int_operand = if unsigned then UInt(operand) else SInt(operand);
real_operand = int_operand / 2^fraction_bits;
if real_operand == 0.0 then
    result = FPZero('0', N);
else
    result = FPRound(real_operand, N, fpscr_val);
return result;

```

A2.8 Polynomial arithmetic over {0,1}

The polynomial data type represents a polynomial in x of the form $b_{n-1}x^{n-1} + \dots + b_1x + b_0$ where b_k is bit [k] of the value.

The coefficients 0 and 1 are manipulated using the rules of Boolean arithmetic:

- $0 + 0 = 1 + 1 = 0$
- $0 + 1 = 1 + 0 = 1$
- $0 * 0 = 0 * 1 = 1 * 0 = 0$
- $1 * 1 = 1$.

That is:

- adding two polynomials over {0,1} is the same as a bitwise exclusive OR
- multiplying two polynomials over {0,1} is the same as integer multiplication except that partial products are exclusive-ORed instead of being added.

A2.8.1 Pseudocode details of polynomial multiplication

In pseudocode, polynomial addition is described by the EOR operation on bitstrings.

Polynomial multiplication is described by the `PolynomialMult()` function:

```
// PolynomialMult()
// =====

bits(M+N) PolynomialMult(bits(M) op1, bits(N) op2)
    result = Zeros(M+N);
    extended_op2 = Zeros(M) : op2;
    for i=0 to M-1
        if op1<i> == '1' then
            result = result EOR LSL(extended_op2, i);
    return result;
```

A2.9 Coprocessor support

Coprocessor space is used to extend the functionality of an ARM processor. There are sixteen coprocessors defined in the coprocessor instruction space. These are commonly known as CP0 to CP15. The following coprocessors are reserved by ARM for specific purposes:

- Coprocessor 15 (CP15) provides system control functionality. This includes architecture and feature identification, as well as control, status information and configuration support. The following sections describe CP15:

- *CP15 registers for a VMSA implementation* on page B3-64

- *CP15 registers for a PMSA implementation* on page B4-22.

CP15 also provides performance monitor registers, see Chapter C9 *Performance Monitors*.

- Coprocessor 14 (CP14) supports:
 - debug, see Chapter C6 *Debug Register Interfaces*
 - the execution environment features defined by the architecture, see *Execution environment support* on page A2-69.
- Coprocessor 11 (CP11) supports double-precision floating-point operations.
- Coprocessor 10 (CP10) supports single-precision floating-point operations and the control and configuration of both the VFP and the Advanced SIMD architecture extensions.
- Coprocessors 8, 9, 12, and 13 are reserved for future use by ARM.

Note

Any implementation that includes either or both of the Advanced SIMD extension and the VFP extension must enable access to both CP10 and CP11, see *Enabling Advanced SIMD and floating-point support* on page B1-64.

In general, privileged access is required for:

- system control through CP15
- debug control and configuration
- access to the identification registers
- access to any register bits that enable or disable coprocessor features.

For details of the exact split between the privileged and unprivileged coprocessor operations see the relevant sections of this manual.

All load, store, branch and data operation instructions associated with floating-point, Advanced SIMD and execution environment support can execute unprivileged.

Coprocessors 0 to 7 can be used to provide vendor specific features.

A2.10 Execution environment support

The Jazelle and ThumbEE states, introduced in *ISETSTATE* on page A2-15, support execution environments:

- The ThumbEE state is more generic, supporting a variant of the Thumb instruction set that minimizes the code size overhead generated by a *Just-In-Time* (JIT) or *Ahead-Of-Time* (AOT) compiler. JIT and AOT compilers convert execution environment source code to a native executable. For more information, see *Thumb Execution Environment*.
- The Jazelle state is specific to hardware acceleration of Java bytecodes. For more information, see *Jazelle direct bytecode execution support* on page A2-73.

A2.10.1 Thumb Execution Environment

Thumb Execution Environment (ThumbEE) is a variant of the Thumb instruction set designed as a target for dynamically generated code. This is code that is compiled on the device, from a portable bytecode or other intermediate or native representation, either shortly before or during execution. ThumbEE provides support for *Just-In-Time* (JIT), *Dynamic Adaptive Compilation* (DAC) and *Ahead-Of-Time* (AOT) compilers, but cannot interwork freely with the ARM and Thumb instruction sets.

ThumbEE is particularly suited to languages that feature managed pointers and array types.

ThumbEE executes instructions in the ThumbEE instruction set state. For information about instruction set states see *ISETSTATE* on page A2-15.

See *Thumb Execution Environment* on page B1-73 for system level information about ThumbEE.

ThumbEE instructions

In ThumbEE state, the processor executes almost the same instruction set as in Thumb state. However some instructions behave differently, some are removed, and some ThumbEE instructions are added.

The key differences are:

- additional instructions to change instruction set in both Thumb state and ThumbEE state
- new ThumbEE instructions to branch to handlers
- null pointer checking on load/store instructions executed in ThumbEE state
- an additional instruction in ThumbEE state to check array bounds
- some other modifications to load, store, and control flow instructions.

For more information about the ThumbEE instructions see Chapter A9 *ThumbEE*.

ThumbEE configuration

ThumbEE introduces two new registers:

- ThumbEE Configuration Register, TEECR. This contains a single bit, the ThumbEE configuration control bit, XED.

- ThumbEE Handler Base Register. This contains the base address for ThumbEE handlers.
A handler is a short, commonly executed, sequence of instructions. It is typically, but not always, associated directly with one or more bytecodes or other intermediate language elements.

Changes to these CP14 registers have the same synchronization requirements as changes to the CP15 registers. These are described in:

- *Changes to CP15 registers and the memory order model* on page B3-77 for a VMSA implementation
- *Changes to CP15 registers and the memory order model* on page B4-28 for a PMSA implementation.

ThumbEE is an unprivileged, user-level facility, and there are no special provisions for using it securely. For more information, see *ThumbEE and the Security Extensions* on page B1-73.

ThumbEE Configuration Register (TEECR)

The ThumbEE Configuration Register (TEECR) controls unprivileged access to the ThumbEE Handler Base Register.

The TEECR is:

- a CP14 register
- a 32-bit register, with access rights that depend on the current privilege:
 - the result of an unprivileged write to the register is UNDEFINED
 - unprivileged reads, and privileged reads and writes, are permitted.
- when the Security Extensions are implemented, a Common register.

The format of the TEECR is:

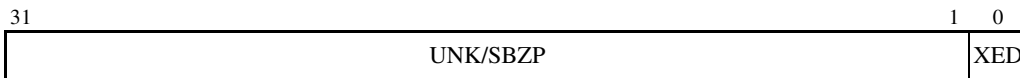

Bits [31:1] UNK/SBZP.

XED, bit [0] Execution Environment Disable bit. Controls unprivileged access to the ThumbEE Handler Base Register:

- 0** Unprivileged access permitted.
- 1** Unprivileged access disabled.

The reset value of this bit is 0.

The effects of a write to this register on ThumbEE configuration are only guaranteed to be visible to subsequent instructions after the execution of an ISB instruction, an exception entry or an exception return. However, a read of this register always returns the value most recently written to the register.

To access the TEECR, read or write the CP14 registers with an MRC or MCR instruction with <opc1> set to 6, <CRn> set to c0, <CRm> set to c0, and <opc2> set to 0. For example:

```
MRC p14, 6, <Rt>, c0, c0, 0 ; Read ThumbEE Configuration Register
MCR p14, 6, <Rt>, c0, c0, 0 ; Write ThumbEE Configuration Register
```

ThumbEE Handler Base Register (TEEHBR)

The ThumbEE Handler Base Register (TEEHBR) holds the base address for ThumbEE handlers.

The TEEHBR is:

- a CP14 register
- a 32-bit read/write register, with access rights that depend on the current privilege and the value of the TEECR.XED bit:
 - privileged accesses are always permitted
 - when TEECR.XED == 0, unprivileged accesses are permitted
 - when TEECR.XED == 1, the result of an unprivileged access is UNDEFINED.
- when the Security Extensions are implemented, a Common register.

The format of the TEEHBR is:

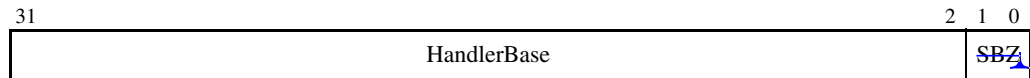
**HandlerBase, bits [31:2]**

The address of the ThumbEE Handler_00 implementation. This is the address of the first of the ThumbEE handlers.

The reset value of this field is UNKNOWN.

bits [1:0] Reserved, **SBZ**

The effects of a write to this register on ThumbEE handler entry are only guaranteed to be visible to subsequent instructions after the execution of an ISB instruction, an exception entry or an exception return. However, a read of this register always returns the value most recently written to the register.

To access the TEEHBR, read or write the CP14 registers with an MRC or MCR instruction with <opc1> set to 6, <CRn> set to c1, <CRm> set to c0, and <opc2> set to 0. For example:

```
MRC p14, 6, <Rt>, c1, c0, 0 ; Read ThumbEE Handler Base Register
MCR p14, 6, <Rt>, c1, c0, 0 ; Write ThumbEE Handler Base Register
```

Use of HandlerBase

ThumbEE handlers are entered by reference to a HandlerBase address, defined by the TEEHBR. See *ThumbEE Handler Base Register (TEEHBR)* on page A2-71. Table A2-13 shows how the handlers are arranged in relation to the value of HandlerBase:

Table A2-13 Access to ThumbEE handlers

Offset from HandlerBase	Name	Value stored
-0x0008	IndexCheck	Branch to IndexCheck handler
-0x0004	NullCheck	Branch to NullCheck handler
+0x0000	Handler_00	Implementation of Handler_00
+0x0020	Handler_01	Implementation of Handler_01
...
+ (0x0000 + 32n)	Handler_<n>	Implementation of Handler_<n>
...	...	Implementation of additional handlers

The IndexCheck occurs when a CHKA instruction detects an index out of range. For more information, see *CHKA* on page A9-15.

The NullCheck occurs when any memory access instruction is executed with a value of 0 in the base register. For more information, see *Null checking* on page A9-3.

Note

Checks are similar to conditional branches, with the added property that they clear the IT bits when taken.

Other handlers are called using explicit handler call instructions. For details see the following sections:

- *HB*, *HBL* on page A9-16
- *HBLP* on page A9-17
- *HBP* on page A9-18.

A2.10.2 Jazelle direct bytecode execution support

From ARMv5TEJ, the architecture requires every system to include an implementation of the Jazelle extension. The Jazelle extension provides architectural support for hardware acceleration of bytecode execution by a *Java Virtual Machine (JVM)*.

In the simplest implementations of the Jazelle extension, the processor does not accelerate the execution of any bytecodes, and the JVM uses software routines to execute all bytecodes. Such an implementation is called a *trivial implementation* of the Jazelle extension, and has minimal additional cost compared with not implementing the Jazelle extension at all. An implementation that provides hardware acceleration of bytecode execution is a non-trivial Jazelle implementation.

These requirements for the Jazelle extension mean a JVM can be written to both:

- function correctly on all processors that include a Jazelle extension implementation
- automatically take advantage of the accelerated bytecode execution provided by a processor that includes a non-trivial implementation.

Typically, a non-trivial implementation of the Jazelle extension implements a subset of the bytecodes in hardware, choosing bytecodes that:

- can have simple hardware implementations
- account for a large percentage of bytecode execution time.

The required features of a non-trivial implementation are:

- provision of the Jazelle state
- a new instruction, BXJ, to enter Jazelle state
- system support that enables an operating system to regulate the use of the Jazelle extension hardware
- system support that enables a JVM to configure the Jazelle extension hardware to its specific needs.

The required features of a trivial implementation are:

- Normally, the Jazelle instruction set state is never entered. If an incorrect exception return causes entry to the Jazelle instruction set state, the next instruction executed is treated as UNDEFINED.
- The BXJ instruction behaves as a BX instruction.
- Configuration support that maintains the interface to the Jazelle extension is permanently disabled.

For more information about trivial implementations see *Trivial implementation of the Jazelle extension* on page B1-81.

A JVM that has been written to take advantage automatically of hardware-accelerated bytecode execution is known as an *Enabled JVM (EJVM)*.

Subarchitectures

A processor implementation that includes the Jazelle extension expects the general-purpose register values and other resources of the ARM processor to conform to an interface standard defined by the Jazelle implementation when Jazelle state is entered and exited. For example, a specific general-purpose register might be reserved for use as the pointer to the current bytecode.

In order for an EJVM and associated debug support to function correctly, it must be written to comply with the interface standard defined by the acceleration hardware at Jazelle state execution entry and exit points.

An implementation of the Jazelle extension might define other configuration registers in addition to the architecturally defined ones.

The interface standard and any additional configuration registers used to communicate with the Jazelle extension are known collectively as the *subarchitecture* of the implementation. They are not described in this manual. Only EJVM implementations and debug or similar software can depend on the subarchitecture. All other software must rely only on the architectural definition of the Jazelle extension given in this manual. A particular subarchitecture is identified by reading the JIDR described in *Jazelle ID Register (JIDR)* on page A2-76.

Jazelle state

While the processor is in Jazelle state, it executes bytecode programs. A bytecode program is defined as an executable object that comprises one or more class files, or is derived from and functionally equivalent to one or more class files. See Lindholm and Yellin, *The Java Virtual Machine Specification 2nd Edition* for the definition of class files.

While the processor is in Jazelle state, the PC identifies the next JVM bytecode to be executed. A JVM bytecode is a bytecode defined in Lindholm and Yellin, or a functionally equivalent transformed version of a bytecode defined in Lindholm and Yellin.

For the Jazelle extension, the functionality of *Native methods*, as described in Lindholm and Yellin, must be specified using only instructions from the ARM, Thumb, and ThumbEE instruction sets.

An implementation of the Jazelle extension must not be documented or promoted as performing any task while it is in Jazelle state other than the acceleration of bytecode programs in accordance with this section and *The Java Virtual Machine Specification*.

Jazelle state entry instruction, BXJ

ARMv7 includes an ARM instruction similar to BX. The BXJ instruction has a single register operand that specifies a target instruction set state, ARM state or Thumb state, and branch target address for use if entry to Jazelle state is not available. For more information, see *BXJ* on page A8-64.

Correct entry into Jazelle state involves the EJVM executing the BXJ instruction at a time when both:

- the Jazelle extension Control and Configuration registers are initialized correctly, see *Application level configuration and control of the Jazelle extension* on page A2-75

- application level registers and any additional configuration registers are initialized as required by the subarchitecture of the implementation.

Executing BXJ with Jazelle extension enabled

Executing a BXJ instruction when the JMCR.JE bit is 1, see *Jazelle Main Configuration Register (JMCR)* on page A2-77, causes the Jazelle hardware to do one of the following:

- enter Jazelle state and start executing bytecodes directly from a SUBARCHITECTURE DEFINED address
- branch to a SUBARCHITECTURE DEFINED handler.

Which of these occurs is SUBARCHITECTURE DEFINED.

The Jazelle subarchitecture can use Application Level registers (but not System Level registers) to transfer information between the Jazelle extension and the EJVM. There are SUBARCHITECTURE DEFINED restrictions on what Application Level registers must contain when a BXJ instruction is executed, and Application Level registers have SUBARCHITECTURE DEFINED values when Jazelle state execution ends and ARM or Thumb state execution resumes.

Jazelle subarchitectures and implementations must not use any unallocated bits in Application Level registers such as the CPSR or FPSCR. All such bits are reserved for future expansion of the ARM architecture.

Executing BXJ with Jazelle extension disabled

If a BXJ instruction is executed when the JMCR.JE bit is 0, it is executed identically to a BX instruction with the same register operand.

This means that BXJ instructions can be executed freely when the JMCR.JE bit is 0. In particular, if an EJVM determines that it is executing on a processor whose Jazelle extension implementation is trivial or uses an incompatible subarchitecture, it can set JE == 0 and execute correctly. In this case it executes without the benefit of any Jazelle hardware acceleration that might be present.

Application level configuration and control of the Jazelle extension

All registers associated with the Jazelle extension are implemented in coprocessor space as part of coprocessor 14 (CP14). The registers are accessed using the instructions:

- MCR, see *MCR, MCR2* on page A8-186
- MRC, see *MRC, MRC2* on page A8-202.

In a non-trivial implementation at least three registers are required. These are described in:

- *Jazelle ID Register (JIDR)* on page A2-76
- *Jazelle Main Configuration Register (JMCR)* on page A2-77
- *Jazelle OS Control Register (JOSCR)* on page B1-77.

Additional configuration registers might be provided and are SUBARCHITECTURE DEFINED.

The following rules apply to all Jazelle extension control and configuration registers:

- All configuration registers are accessed by CP14 MRC and MCR instructions with <opc1> set to 7.

- The values contained in configuration registers are changed only by the execution of MCR instructions. In particular, they are never changed by Jazelle state execution of bytecodes.
- The access policy for the required registers is fully defined in their descriptions. With unprivileged operation:
 - all MCR accesses to the JIDR are UNDEFINED
 - MRC and MCR accesses that are restricted to privileged modes are UNDEFINED.The access policy of other configuration registers is SUBARCHITECTURE DEFINED.
- When the Security Extensions are implemented, the registers are common to the Secure and Non-secure security states. For more information, see *Effect of the Security Extensions on the CP15 registers* on page B3-71. This section applies to some CP14 registers as well as to the CP15 registers.
- When a configuration register is readable, reading the register returns the last value written to it. Reading a readable configuration register has no side effects.
When a configuration register is not readable, attempting to read it returns an UNKNOWN value.
- When a configuration register can be written, the effect of writing to it must be idempotent. That is, the overall effect of writing the same value more than once must not differ from the effect of writing it once.

Changes to these CP14 registers have the same synchronization requirements as changes to the CP15 registers. These are described in:

- *Changes to CP15 registers and the memory order model* on page B3-77 for a VMSA implementation
- *Changes to CP15 registers and the memory order model* on page B4-28 for a PMSA implementation.

For more information, see *Jazelle state configuration and control* on page B1-77.

Jazelle ID Register (JIDR)

The Jazelle ID Register (JIDR) enables an EJVM to determine the architecture and subarchitecture under which it is running.

The JIDR is:

- a CP14 register
- a 32-bit read-only register
- accessible during privileged and unprivileged execution
- when the Security Extensions are implemented, a Common register, see *Common CP15 registers* on page B3-74.

The format of the JIDR is:

31	28 27	20 19	12 11	0
Architecture	Implementer	Subarchitecture	SUBARCHITECTURE DEFINED	

Architecture, bits [31:28]

Architecture code. This uses the same Architecture code that appears in the Main ID register in coprocessor 15, see *c0, Main ID Register (MIDR)* on page B3-81 (VMSA implementation) or *c0, Main ID Register (MIDR)* on page B4-32 (PMSA implementation).

Implementer, bits [27:20]

Implementer code of the designer of the subarchitecture. This uses the same Implementer code that appears in the Main ID register in coprocessor 15, see *c0, Main ID Register (MIDR)* on page B3-81 (VMSA implementation) or *c0, Main ID Register (MIDR)* on page B4-32 (PMSA implementation).

If the trivial implementation of the Jazelle extension is used, the Implementer code is `0x00`.

Subarchitecture, bits [19:12]

Contain the subarchitecture code. The following subarchitecture code is defined:

`0x00` Jazelle v1 subarchitecture, or trivial implementation of Jazelle extension if Implementer code is `0x00`.

bits [11:0] Contain additional SUBARCHITECTURE DEFINED information.

To access the JIDR, read the CP14 registers with an MRC instruction with `<opc1>` set to 7, `<CRn>` set to `c0`, `<CRm>` set to `c0`, and `<opc2>` set to 0. For example:

```
MRC p14, 7, <Rt>, c0, c0, 0 ; Read Jazelle ID register
```

Jazelle Main Configuration Register (JMCR)

The Jazelle Main Configuration Register (JMCR) controls the Jazelle extension.

The JMCR is:

- a CP14 register
- a 32-bit register, with access rights that depend on the current privilege:
 - for privileged operations the register is read/write
 - for unprivileged operations, the register is normally write-only
- when the Security Extensions are implemented, a Common register, see *Common CP15 registers* on page B3-74.

For more information about unprivileged access restrictions see *Access to Jazelle registers* on page A2-78.

The format of the JMCR is:



bit [31:1] SUBARCHITECTURE DEFINED information.

JE, bit [0] Jazelle Enable bit:

0 Jazelle extension disabled. The BXJ instruction does not cause Jazelle state execution. BXJ behaves exactly as a BX instruction, see *Jazelle state entry instruction, BXJ* on page A2-74.

1 Jazelle extension enabled.

The reset value of this bit is 0.

To access the JMCR, read or write the CP14 registers with an MRC or MCR instruction with <opc1> set to 7, <CRn> set to c2, <CRm> set to c0, and <opc2> set to 0. For example:

MRC p14, 7, <Rt>, c2, c0, 0 ; Read Jazelle Main Configuration register

MCR p14, 7, <Rt>, c2, c0, 0 ; Write Jazelle Main Configuration register

Access to Jazelle registers

Table A2-14 shows the access permissions for the Jazelle registers, and how unprivileged access to the registers depends on the value of the JOSCR.

Table A2-14 Access to Jazelle registers

Jazelle register	Unprivileged access		Privileged access
	JOSCR.CD == 0 ^a	JOSCR.CD == 1 ^a	
JIDR	Read access permitted	Read and write access UNDEFINED	Read access permitted
	Write access ignored		Write access ignored
JMCR	Read access UNDEFINED	Read and write access UNDEFINED	Read and write access permitted
	Write access permitted		
SUBARCHITECTURE DEFINED configuration registers	Read access UNDEFINED	Read and write access UNDEFINED	Read access SUBARCHITECTURE DEFINED
	Write access permitted		Write access permitted

a. See *Jazelle OS Control Register (JOSCR)* on page B1-77.

EJVM operation

The following subsections summarize how an EJVM must operate, to meet the requirements of the architecture:

- *Initialization*
- *Bytecode execution*
- *Jazelle exception conditions*
- *Other considerations* on page A2-80.

Initialization

During initialization, the EJVM must first check which subarchitecture is present, by checking the Implementer and Subarchitecture codes in the value read from the JIDR.

If the EJVM is incompatible with the subarchitecture, it must do one of the following:

- write a value with $JE == 0$ to the JMCR
- if unaccelerated bytecode execution is unacceptable, generate an error.

If the EJVM is compatible with the subarchitecture, it must write its required configuration to the JMCR and any SUBARCHITECTURE DEFINED configuration registers.

Bytecode execution

The EJVM must contain a handler for each bytecode.

The EJVM initiates bytecode execution by executing a BXJ instruction with:

- the register operand specifying the target address of the bytecode handler for the first bytecode of the program
- the Application Level registers set up in accordance with the SUBARCHITECTURE DEFINED interface standard.

The bytecode handler:

- performs the data-processing operations required by the bytecode indicated
- determines the address of the next bytecode to be executed
- determines the address of the handler for that bytecode
- performs a BXJ to that handler address with the registers again set up to the SUBARCHITECTURE DEFINED interface standard.

Jazelle exception conditions

During bytecode execution, the EJVM might encounter SUBARCHITECTURE DEFINED Jazelle exception conditions that must be resolved by a software handler. For example, in the case of a *configuration invalid* handler, the handler rewrites the desired configuration to the JMCR and to any SUBARCHITECTURE DEFINED configuration registers.

On entry to a Jazelle exception condition handler the contents of the Application Level registers are SUBARCHITECTURE DEFINED. This interface to the Jazelle exception condition handler might differ from the interface standard for the bytecode handler, in order to supply information about the Jazelle exception condition.

The Jazelle exception condition handler:

- resolves the Jazelle exception condition
- determines the address of the next bytecode to be executed
- determines the address of the handler for that bytecode
- performs a BXJ to that handler address with the registers again set up to the SUBARCHITECTURE DEFINED interface standard.

Other considerations

To ensure application execution and correct interaction with an operating system, an EJVM must only perform operations that are permitted in unprivileged operation. In particular, for register accesses they must only:

- read the JIDR,
- write to the JMCR, and other configuration registers.

An EJVM must not attempt to access the JOSCR.

A2.11 Exceptions, debug events and checks

ARMv7 uses the following terms to describe various types of exceptional condition:

Exceptions In the ARM architecture, *exceptions* cause entry into a privileged mode and execution of a software handler for the exception.

Note

The terms *floating-point exception* and *Jazelle exception condition* do not use this meaning of *exception*. These terms are described later in this list.

Exceptions include:

- reset
- interrupts
- memory system aborts
- undefined instructions
- supervisor calls (SVCs).

Most details of exception handling are not visible to application-level code, and are described in *Exceptions* on page B1-30. Aspects that are visible to application-level code are:

- The SVC instruction causes an SVC exception. This provides a mechanism for unprivileged code to make a call to the operating system (or other privileged component of the software system).
- If the Security Extensions are implemented, the SMC instruction causes an SMC exception, but only if it is executed in a privileged mode. Unprivileged code can only cause SMC exceptions to occur by methods defined by the operating system (or other privileged component of the software system).
- The WFI instruction provides a hint that nothing needs to be done until an interrupt or similar exception is taken, see *Wait For Interrupt* on page B1-47. This permits the processor to enter a low-power state until that happens.
- The WFE instruction provides a hint that nothing needs to be done until either an *event* is generated by an SEV instruction or an interrupt or similar exception is taken, see *Wait For Event and Send Event* on page B1-44. This permits the processor to enter a low-power state until one of these happens.
- The YIELD instruction provides a hint that the current execution thread is of low importance, see *The Yield instruction* on page A2-82.

Floating-point exceptions

These relate to exceptional conditions encountered during floating-point arithmetic, such as division by zero or overflow. For more information see:

- *Floating-point exceptions* on page A2-42
- *Floating-point Status and Control Register (FPSCR)* on page A2-28
- ANSI/IEEE Std. 754-1985, *IEEE Standard for Binary Floating-Point Arithmetic*.

Jazelle exception conditions

These are conditions that cause Jazelle hardware acceleration to exit into a software handler, as described in *Jazelle exception conditions* on page A2-79.

Debug events These are conditions that cause a debug system to take action. Most aspects of debug events are not visible to application-level code, and are described in Chapter C3 *Debug Events*. Aspects that are visible to application-level code include:

- The BKPT instruction causes a BKPT Instruction debug event to occur, see *BKPT Instruction debug events* on page C3-20.
- The DBG instruction provides a hint to the debug system.

Checks These are provided in the ThumbEE extension. A check causes an unconditional branch to a specific handler entry point. The base address of the ThumbEE check handlers is held in the TEEHBR, see *ThumbEE Handler Base Register (TEEHBR)* on page A2-71.

A2.11.1 The Yield instruction

In a *Symmetric Multi-Threading* (SMT) design, a thread can use a Yield instruction to give a hint to the processor that it is running on. The Yield hint indicates that whatever the thread is currently doing is of low importance, and so could yield. For example, the thread might be sitting in a spin-lock. Similar behavior might be used to modify the arbitration priority of the snoop bus in a multiprocessor (MP) system. Defining such an instruction permits binary compatibility between SMT and SMP systems.

ARMv7 defines a YIELD instruction as a specific NOP-hint instruction, see *YIELD* on page A8-812.

The YIELD instruction has no effect in a single-threaded system, but developers of such systems can use the instruction to flag its intended use on migration to a multiprocessor or multithreading system. Operating systems can use YIELD in places where a yield hint is wanted, knowing that it will be treated as a NOP if there is no implementation benefit.

Chapter A3

Application Level Memory Model

This chapter gives an application level view of the memory model. It contains the following sections:

- *Address space* on page A3-2
- *Alignment support* on page A3-4
- *Endian support* on page A3-7
- *Synchronization and semaphores* on page A3-12
- *Memory types and attributes and the memory order model* on page A3-24
- *Access rights* on page A3-38
- *Virtual and physical addressing* on page A3-40
- *Memory access order* on page A3-41
- *Caches and memory hierarchy* on page A3-51.

A3.1 Address space

The ARM architecture uses a single, flat address space of 2^{32} 8-bit bytes. Byte addresses are treated as unsigned numbers, running from 0 to $2^{32} - 1$. The address space is also regarded as:

- 2^{30} 32-bit words:
 - the address of each word is word-aligned, meaning that the address is divisible by 4 and the last two bits of the address are 0b00
 - the word at word-aligned address A consists of the four bytes with addresses A, A+1, A+2 and A+3.
- 2^{31} 16-bit halfwords:
 - the address of each halfword is halfword-aligned, meaning that the address is divisible by 2 and the last bit of the address is 0
 - the halfword at halfword-aligned address A consists of the two bytes with addresses A and A+1.

In some situations the ARM architecture supports accesses to halfwords and words that are not aligned to the appropriate access size, see *Alignment support* on page A3-4.

Normally, address calculations are performed using ordinary integer instructions. This means that the address wraps around if the calculation overflows or underflows the address space. Another way of describing this is that any address calculation is reduced modulo 2^{32} .

A3.1.1 Address incrementing and address space overflow

When a processor performs normal sequential execution of instructions, it effectively calculates:

$$(\text{address_of_current_instruction}) + (\text{size_of_executed_instruction})$$

after each instruction to determine which instruction to execute next.

————— **Note** —————

The size of the executed instruction depends on the current instruction set, and might depend on the instruction executed.

If this address calculation overflows the top of the address space, the result is UNPREDICTABLE. In other words, a program must not rely on sequential execution of the instruction at address 0x00000000 after the instruction at address:

- 0xFFFFF0FC, when a 4-byte instruction is executed
- 0xFFFFF0FE, when a 2-byte instruction is executed
- 0xFFFFF0FF, when a single byte instruction is executed.

This UNPREDICTABLE behavior only applies to instructions that are executed, including those that fail their condition code check. Most ARM implementations prefetch instructions ahead of the currently-executing instruction. If this prefetching overflows the top of the address space, it does not cause UNPREDICTABLE behavior unless a prefetched instruction with an overflowed address is actually executed.

LDC, LDM, LDRD, POP, PUSH, STC, STRD, and STM instructions access a sequence of words at increasing memory addresses, effectively incrementing the memory address by 4 for each load or store. If this calculation overflows the top of the address space, the result is UNPREDICTABLE. In other words, programs must not use these instructions in such a way that they attempt to access the word at address `0x00000000` sequentially after the word at address `0xFFFFFFFFC`.

———— **Note** —————

In some cases instructions that operate on multiple words can decrement the memory address by 4 after each word access. If this calculation underflows the address space, by decrementing the address `0x00000000`, the result is UNPREDICTABLE.

—————

The behavior of any unaligned load or store with a calculated address that would access the byte at `0xFFFFFFFF` and the byte at address `0x00000000` as part of the instruction is UNPREDICTABLE.

A3.2 Alignment support

Instructions in the ARM architecture are aligned as follows:

- ARM instructions are word-aligned
- Thumb and ThumbEE instructions are halfword-aligned
- Java bytecodes are byte-aligned.

The data alignment behavior supported by the ARM architecture has changed significantly between ARMv4 and ARMv7. This behavior is indicated by the SCTL.R.U bit, see:

- *c1, System Control Register (SCTLR)* on page B3-96 for a VMSAv7 implementation
- *c1, System Control Register (SCTLR)* on page B4-45 for a PMSAv7 implementation
- *c1, System Control Register (SCTLR)* on page AppxG-34 for architecture versions before ARMv7.

This bit defines the alignment behavior of the memory system for data accesses. Table A3-1 shows the values of SCTL.R.U for the different architecture versions.

Table A3-1 SCTL.R.U bit values for different architecture versions

Architecture version	SCTL.R.U value
Before ARMv6	0
ARMv6	0 or 1
ARMv7	1

On an ARMv6 processor, the SCTL.R.U bit indicates which of two possible alignment models is selected:

U == 0 The processor implements the legacy alignment model. This is described in *Alignment* on page AppxG-6.

Note

The use of U == 0 is deprecated in ARMv6T2, and is obsolete from ARMv7.

U == 1 The processor implements the alignment model described in this section. This model supports unaligned data accesses.

ARMv7 requires the processor to implement the alignment model described in this section.

A3.2.1 Unaligned data access

An ARMv7 implementation must support unaligned data accesses. The SCTL.R.U bit is RAO to indicate this support. The SCTL.R.A bit, the strict alignment bit, controls whether strict alignment is required. The checking of load and store alignment depends on the value of this bit. For more information, see *c1, System Control Register (SCTLR)* on page B3-96 for a VMSA implementation, or *c1, System Control Register (SCTLR)* on page B4-45 for a PMSA implementation.

Table A3-2 shows how the checking of load and store alignment depends on the instruction type and the value of SCTL.R.A.

Table A3-2 Alignment requirements of load/store instructions

Instructions	Alignment check	Result if check fails when:	
		SCTL.R.A == 0	SCTL.R.A == 1
LDRB, LDREXB, LDRBT, LDRSB, LDRSBT, STRB, STREXB, STRBT, SWPB, TBB	None	-	-
LDRH, LDRHT, LDRSH, LDRSHT, STRH, STRHT, TBH	Halfword	Unaligned access	Alignment fault
LDREXH, STREXH	Halfword	Alignment fault	Alignment fault
LDR, LDRT, STR, STRT	Word	Unaligned access	Alignment fault
LDREX, STREX	Word	Alignment fault	Alignment fault
LDREXD, STREXD	Doubleword	Alignment fault	Alignment fault
All forms of LDM, LDRD, PUSH, POP, RFE, SRS, all forms of STM, STRD, SWP	Word	Alignment fault	Alignment fault
LDC, LDC2, STC, STC2	Word	Alignment fault	Alignment fault
VLDM, VLDR, VSTM, VSTR	Word	Alignment fault	Alignment fault
VLD1, VLD2, VLD3, VLD4, VST1, VST2, VST3, VST4, all with standard alignment ^a	Element size	Unaligned access	Alignment fault
VLD1, VLD2, VLD3, VLD4, VST1, VST2, VST3, VST4, all with @<align> specified ^a	As specified by @<align>	Alignment fault	Alignment fault

- a. These element and structure load/store instructions are only in the Advanced SIMD extension to the ARMv7 ARM and Thumb instruction sets. ARMv7 does not support the pre-ARMv6 alignment model, so you cannot use that model with these instructions.

A3.2.2 Cases where unaligned accesses are UNPREDICTABLE

The following cases cause the resulting unaligned accesses to be UNPREDICTABLE, and overrule any successful load or store behavior described in *Unaligned data access* on page A3-5:

- Any load instruction that is not faulted by the alignment restrictions and that loads the PC has UNPREDICTABLE behavior if ~~it~~ the address it loads from is not word-aligned.
- Any unaligned access that is not faulted by the alignment restrictions and that accesses memory with the Strongly-ordered or Device attribute has UNPREDICTABLE behavior.

———— **Note** —————

These memory attributes are described in *Memory types and attributes and the memory order model* on page A3-24.

—————

A3.2.3 Unaligned data access restrictions in ARMv7 and ARMv6

ARMv7 and ARMv6 have the following restrictions on unaligned data accesses:

- Accesses are not guaranteed to be single-copy atomic, see *Atomicity in the ARM architecture* on page A3-26. An access can be synthesized out of a series of aligned operations in a shared memory system without guaranteeing locked transaction cycles.
- Unaligned accesses typically take a number of additional cycles to complete compared to a naturally aligned transfer. The real-time implications must be analyzed carefully and key data structures might need to have their alignment adjusted for optimum performance.
- If an unaligned access occurs across a page boundary, the operation can abort on either or both halves of the access.

Shared memory schemes must not rely on seeing monotonic updates of non-aligned data of loads and stores for data items larger than byte wide. For more information, see *Atomicity in the ARM architecture* on page A3-26.

Unaligned access operations must not be used for accessing Device memory-mapped registers. They must only be used with care in shared memory structures that are protected by aligned semaphores or synchronization variables.

A3.3 Endian support

The rules in *Address space* on page A3-2 require that for a word-aligned address A:

- the word at address A consists of the bytes at addresses A, A+1, A+2 and A+3
- the halfword at address A consists of the bytes at addresses A and A+1
- the halfword at address A+2 consists of the bytes at addresses A+2 and A+3.
- the word at address A therefore consists of the halfwords at addresses A and A+2.

However, this does not specify completely the mappings between words, halfwords, and bytes.

A memory system uses one of the two following mapping schemes. This choice is known as the endianness of the memory system.

In a *little-endian* memory system:

- the byte or halfword at a word-aligned address is the least significant byte or halfword in the word at that address
- the byte at a halfword-aligned address is the least significant byte in the halfword at that address.

In a *big-endian* memory system:

- the byte or halfword at a word-aligned address is the most significant byte or halfword in the word at that address
- the byte at a halfword-aligned address is the most significant byte in the halfword at that address.

For a word-aligned address A, Table A3-3 and Table A3-4 on page A3-8 show the relationship between:

- the word at address A
- the halfwords at addresses A and A+2
- the bytes at addresses A, A+1, A+2 and A+3.

Table A3-3 shows this relationship for a big-endian memory system, and Table A3-4 on page A3-8 shows the relationship for a little-endian memory system.

Table A3-3 Big-endian memory system

MSByte	MSByte - 1	LSByte + 1	LSByte
Word at Address A			
Halfword at Address A		Halfword at Address A+2	
Byte at Address A	Byte at Address A+1	Byte at Address A+2	Byte at Address A+3

Table A3-4 Little-endian memory system

MSByte	MSByte - 1	LSByte + 1	LSByte
Word at Address A			
Halfword at Address A+2		Halfword at Address A	
Byte at Address A+3	Byte at Address A+2	Byte at Address A+1	Byte at Address A

The big-endian and little-endian mapping schemes determine the order in which the bytes of a word or halfword are interpreted. For example, a load of a word (4 bytes) from address $0x1000$ always results in an access of the bytes at memory locations $0x1000$, $0x1001$, $0x1002$, and $0x1003$. The endianness mapping scheme determines the significance of these four bytes.

A3.3.1 Control of the endianness mapping scheme in ARMv7

In ARMv7-A, the mapping of instruction memory is always little-endian. In ARMv7-R, instruction endianness can be controlled at the system level, see *Instruction endianness*.

For information about data memory endianness control, see *ENDIANSTATE* on page A2-19.

———— Note —————

Versions of the ARM architecture before ARMv7 had a different mechanism to control the endianness, see *Endian configuration and control* on page AppxG-20.

A3.3.2 Instruction endianness

Before ARMv7, the ARM architecture included legacy support for an alternative big-endian memory model, described as BE-32 and controlled by the B bit, bit [7], of the SCTLR, see *c1, System Control Register (SCTLR)* on page AppxG-34. ARMv7 does not support BE-32 operation, and bit [7] of the SCTLR is RAZ.

Where legacy object code for ARM processors contains instructions with a big-endian byte order, the removal of support for BE-32 operation requires the instructions in the object files to have their bytes reversed for the code to be executed on an ARMv7 processor. This means that:

- each Thumb instruction, whether a 32-bit Thumb instruction or a 16-bit Thumb instruction, must have the byte order of each halfword of instruction reversed
- each ARM instruction must have the byte order of each word of instruction reversed.

For most situations, this can be handled in the link stage of a tool-flow, provided the object files include sufficient information to permit this to happen. In practice, this is the situation for all applications with the ARMv7-A profile.

For applications of the ARMv7-R profile, there are some legacy code situations where the arrangement of the bytes in the object files cannot be adjusted by the linker. For these object files to be used by an ARMv7-R processor the byte order of the instructions must be reversed by the processor at runtime. Therefore, the ARMv7-R profile permits configuration of the instruction endianness.

Instruction endianness static configuration, ARMv7-R only

To provide support for legacy big-endian object code, the ARMv7-R profile supports optional byte order reversal hardware as a static option from reset. The ARMv7-R profile includes a read-only bit in the CP15 Control Register, SCTL.R.IE, bit [31]. For more information, see *c1, System Control Register (SCTLR)* on page B4-45.

A3.3.3 Element size and endianness

The effect of the endianness mapping on data transfers depends on the size of the data element or elements transferred by the load/store instructions. Table A3-5 lists the element sizes of all the load/store instructions, for all instruction sets.

Table A3-5 Element size of load/store instructions

Instructions	Element size
LDRB, LDREXB, LDRBT, LDRSB, LDRSBT, STRB, STREXB, STRBT, SWPB, TBB	Byte
LDRH, LDREXH, LDRHT, LDRSH, LDRSHT, STRH, STREXH, STRHT, TBH	Halfword
LDR, LDRT, LDREX, STR, STRT, STREX	Word
LDRD, LDREXD, STRD, STREXD	Word
All forms of LDM, PUSH, POP, RFE, SRS, all forms of STM, SWP	Word
LDC, LDC2, STC, STC2, VLDM, VLDR, VSTM, VSTR	Word
VLD1, VLD2, VLD3, VLD4, VST1, VST2, VST3, VST4	Element size of the Advanced SIMD access

A3.3.4 Instructions to reverse bytes in a general-purpose register

An application or device driver might have to interface to memory-mapped peripheral registers or shared memory structures that are not the same endianness as the internal data structures. Similarly, the endianness of the operating system might not match that of the peripheral registers or shared memory. In these cases, the processor requires an efficient method to transform explicitly the endianness of the data.

In ARMv7, the ARM and Thumb instruction sets provide this functionality. There are instructions to:

- Reverse word (four bytes) register, for transforming big and little-endian 32-bit representations. See *REV* on page A8-272.

- Reverse halfword and sign-extend, for transforming signed 16-bit representations. See *REVSH* on page A8-276.
- Reverse packed halfwords in a register for transforming big- and little-endian 16-bit representations. See *REV16* on page A8-274.

A3.3.5 Endianness in Advanced SIMD

Advanced SIMD element load/store instructions transfer vectors of elements between memory and the Advanced SIMD register bank. An instruction specifies both the length of the transfer and the size of the data elements being transferred. This information is used by the processor to load and store data correctly in both big-endian and little-endian systems.

Consider, for example, the instruction:

```
VLD1.16 {D0}, [R1]
```

This loads a 64-bit register with four 16-bit values. The four elements appear in the register in array order, with the lowest indexed element fetched from the lowest address. The order of bytes in the elements depends on the endianness configuration, as shown in Figure A3-1. Therefore, the order of the elements in the registers is the same regardless of the endianness configuration. This means that Advanced SIMD code is usually independent of endianness.

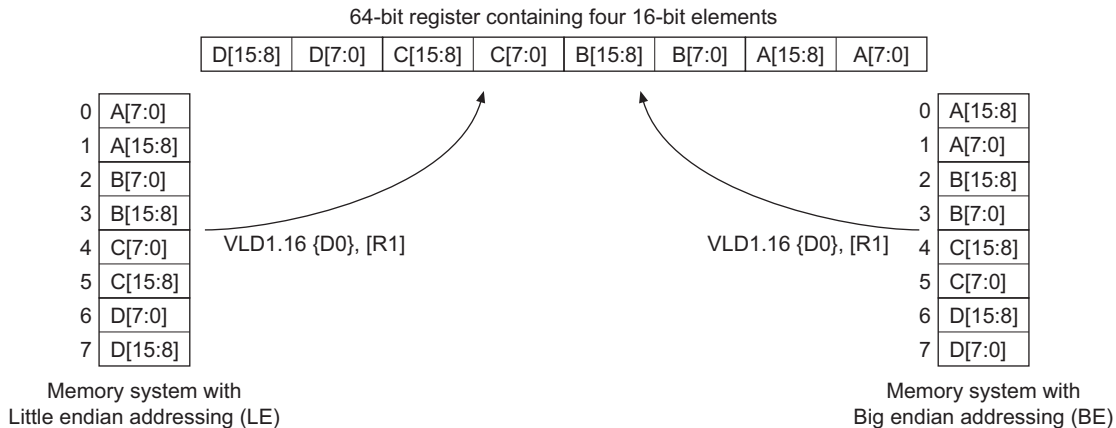

Figure A3-1 Advanced SIMD byte order example

The Advanced SIMD extension supports Little-Endian (LE) and Big-Endian (BE) models.

For information about the alignment of Advanced SIMD instructions see *Unaligned data access* on page A3-5.

———— **Note** ————

Advanced SIMD is an extension to the ARMv7 ARM and Thumb instruction sets. In ARMv7, the SCTL.R.B bit always has the value 0, indicating that ARMv7 does not support the legacy BE-32 endianness model, and you cannot use this model with Advanced SIMD element and structure load/store instructions.

A3.4 Synchronization and semaphores

In architecture versions before ARMv6, support for the synchronization of shared memory depends on the SWP and SWPB instructions. These are read-locked-write operations that swap register contents with memory, and are described in *SWP*, *SWPB* on page A8-432. These instructions support basic busy/free semaphore mechanisms, but do not support mechanisms that require calculation to be performed on the semaphore between the read and write phases.

ARMv6 introduced a new mechanism to support more comprehensive non-blocking synchronization of shared memory, using *synchronization primitives* that scale for multiprocessor system designs. ARMv6 provided a pair of synchronization primitives, LDREX and STREX. ~~ARMv7 extends the new model by:~~

- ~~adding byte, halfword and doubleword versions of the synchronization primitives~~
- ~~adding a Clear-Exclusive instruction, CLREX~~
- ~~adding the synchronization primitives to the Thumb instruction set.~~



Note

From ARMv6, use of the SWP and SWPB instructions is deprecated. ARM strongly recommends that all software migrates to using the new synchronization primitives described in this section.

In ARMv7, the synchronization primitives provided in the ARM and Thumb instruction sets are:

- Load-Exclusives:
 - LDREX, see *LDREX* on page A8-142
 - LDREXB, see *LDREXB* on page A8-144
 - LDREXD, see *LDREXD* on page A8-146
 - LDREXH, see *LDREXH* on page A8-148
- Store-Exclusives:
 - STREX, see *STREX* on page A8-400
 - STREXB, see *STREXB* on page A8-402
 - STREXD, see *STREXD* on page A8-404
 - STREXH, see *STREXH* on page A8-406
- Clear-Exclusive, CLREX, see *CLREX* on page A8-70.

Note

This section describes the operation of a Load-Exclusive/Store-Exclusive pair of synchronization primitives using, as examples, the LDREX and STREX instructions. The same description applies to any other pair of synchronization primitives:

- LDREXB used with STREXB
- LDREXD used with STREXD
- LDREXH used with STREXH.

Each Load-Exclusive instruction must be used only with the corresponding Store-Exclusive instruction.

The model for the use of a Load-Exclusive/Store-Exclusive instruction pair, accessing a non-aborting memory address x is:

- The Load-Exclusive instruction reads a value from memory address x .
- The corresponding Store-Exclusive instruction succeeds in writing back to memory address x only if no other observer, process, or thread has performed a more recent store of address x . The Store-Exclusive operation returns a status bit that indicates whether the memory write succeeded.

A Load-Exclusive instruction tags a small block of memory for exclusive access. The size of the tagged block is IMPLEMENTATION DEFINED, see *Tagging and the size of the tagged memory block* on page A3-20. A Store-Exclusive instruction to the same address clears the tag.

———— **Note** —————

In this section, the term processor includes any observer that can generate a Load-Exclusive or a Store-Exclusive.

A3.4.1 Exclusive access instructions and Non-shareable memory regions

For memory regions that do not have the *Shareable* attribute, the exclusive access instructions rely on a *local monitor* that tags any address from which the processor executes a Load-Exclusive. Any non-aborted attempt by the same processor to use a Store-Exclusive to modify any address is guaranteed to clear the tag.

A Load-Exclusive performs a load from memory, and:

- the executing processor tags the physical memory address for exclusive access
- the local monitor of the executing processor transitions to its Exclusive Access state.

A Store-Exclusive performs a conditional store to memory, that depends on the state of the local monitor:

If the local monitor is in its Exclusive Access state

- If the address of the Store-Exclusive is the same as the address that has been tagged in the monitor by an earlier Load-Exclusive, then the store takes place, otherwise it is IMPLEMENTATION DEFINED whether the store takes place.
- A status value is returned to a register:
 - if the store took place the status value is 0
 - otherwise, the status value is 1.
- The local monitor of the executing processor transitions to its Open Access state.

If the local monitor is in its Open Access state

- no store takes place
- a status value of 1 is returned to a register.
- the local monitor remains in its Open Access state.

The Store-Exclusive instruction defines the register to which the status value is returned.

When a processor writes using any instruction other than a Store-Exclusive:

- if the write is to a physical address that is not covered by its local monitor the write does not affect the state of the local monitor
- if the write is to a physical address that is covered by its local monitor it is IMPLEMENTATION DEFINED whether the write affects the state of the local monitor.

If the local monitor is in its Exclusive Access state and the processor performs a Store-Exclusive to any address other than the last one from which it performed a Load-Exclusive, it is IMPLEMENTATION DEFINED whether the store updates memory, but in all cases the local monitor is reset to its Open Access state. This mechanism:

- is used on a context switch, see *Context switch support* on page A3-21
- must be treated as a software programming error in all other cases.

———— **Note** —————

It is UNPREDICTABLE whether a store to a tagged physical address causes a tag in the local monitor to be cleared if that store is by an observer other than the one that caused the physical address to be tagged.

Figure A3-2 shows the state machine for the local monitor. Table A3-6 on page A3-15 shows the effect of each of the operations shown in the figure.

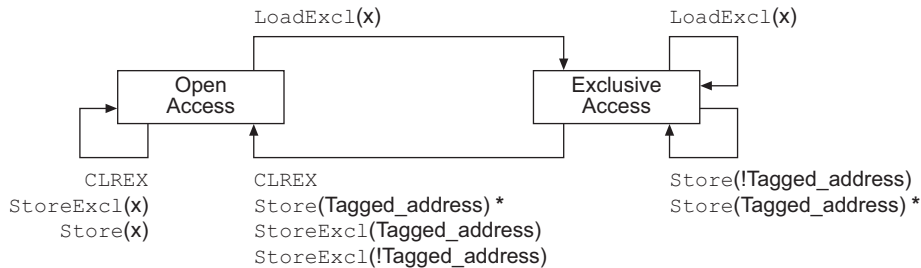

Operations marked * are possible alternative IMPLEMENTATION DEFINED options.

In the diagram: LoadExcl represents any Load-Exclusive instruction
 StoreExcl represents any Store-Exclusive instruction
 Store represents any other store instruction.

Any LoadExcl operation updates the tagged address to the most significant bits of the address x used for the operation. For more information see the section *Size of the tagged memory block*.

Figure A3-2 Local monitor state machine diagram

Note

For the local monitor state machine, as shown in Figure A3-2 on page A3-14:

- The IMPLEMENTATION DEFINED options for the local monitor are consistent with the local monitor being constructed so that it does not hold any physical address, but instead treats any access as matching the address of the previous LoadExc1.
 - A local monitor implementation can be unaware of Load-Exclusive and Store-Exclusive operations from other processors.
 - It is UNPREDICTABLE whether the transition from Exclusive Access to Open Access state occurs when the Store or StoreExc1 is from another observer.
-

Table A3-6 shows the effect of the operations shown in Figure A3-2 on page A3-14.

Table A3-6 Effect of Exclusive instructions and write operations on local monitor

Initial state	Operation ^a	Effect	Final state
Open Access	CLREX	No effect	Open Access
Open Access	StoreExc1(x)	Does not update memory, returns status 1	Open Access
Open Access	LoadExc1(x)	Loads value from memory, tags address x	Exclusive Access
Open Access	Store(x)	Updates memory, no effect on monitor	Open Access
Exclusive Access	CLREX	Clears tagged address	Open Access
Exclusive Access	StoreExc1(t)	Updates memory, returns status 0	Open Access
Exclusive Access	StoreExc1(!t)	Updates memory, returns status 0 ^b Does not update memory, returns status 1 ^b	Open Access
Exclusive Access	LoadExc1(x)	Loads value from memory, changes tag to address to x	Exclusive Access
Exclusive Access	Store(!t)	Updates memory, no effect on monitor	Exclusive Access
Exclusive Access	Store(t)	Updates memory	Exclusive Access ^b Open Access ^b

a. In the table:

LoadExc1 represents any Load-Exclusive instruction

StoreExc1 represents any Store-Exclusive instruction

Store represents any store operation other than a Store-Exclusive operation.

t is the tagged address, bits [31:a] of the address of the last Load-Exclusive instruction. For more information, see *Tagging and the size of the tagged memory block* on page A3-20.

b. IMPLEMENTATION DEFINED alternative actions.

A3.4.2 Exclusive access instructions and Shareable memory regions

For memory regions that have the *Shareable* attribute, exclusive access instructions rely on:

- A *local monitor* for each processor in the system, that tags any address from which the processor executes a Load-Exclusive. The local monitor operates as described in *Exclusive access instructions and Non-shareable memory regions* on page A3-13, except that for Shareable memory any Store-Exclusive is then subject to checking by the global monitor if it is described in that section as doing at least one of:
 - updating memory
 - returning a status value of 0.

The local monitor can ignore exclusive accesses from other processors in the system.

- A *global monitor* that tags a physical address as exclusive access for a particular processor. This tag is used later to determine whether a Store-Exclusive to that address that has not been failed by the local monitor can occur. Any successful write to the tagged address by any other observer in the shareability domain of the memory location is guaranteed to clear the tag. For each processor in the system, the global monitor:
 - holds a single tagged address
 - maintains a state machine.

The global monitor can either reside in a processor block or exist as a secondary monitor at the memory interfaces.

————— **Note** —————

An implementation can combine the functionality of the global and local monitors into a single unit.

Operation of the global monitor

Load-Exclusive from *Shareable* memory performs a load from memory, and causes the physical address of the access to be tagged as exclusive access for the requesting processor. This access also causes the exclusive access tag to be removed from any other physical address that has been tagged by the requesting processor. The global monitor only supports a single outstanding exclusive access to Shareable memory per processor.

Store-Exclusive performs a conditional store to memory:

- The store is guaranteed to succeed only if the physical address accessed is tagged as exclusive access for the requesting processor and both the local monitor and the global monitor state machines for the requesting processor are in the Exclusive Access state. In this case:
 - a status value of 0 is returned to a register to acknowledge the successful store
 - the final state of the global monitor state machine for the requesting processor is IMPLEMENTATION DEFINED
 - if the address accessed is tagged for exclusive access in the global monitor state machine for any other processor then that state machine transitions to Open Access state.

- If no address is tagged as exclusive access for the requesting processor, the store does not succeed:
 - a status value of 1 is returned to a register to indicate that the store failed
 - the global monitor is not affected and remains in Open Access state for the requesting processor.
- If a different physical address is tagged as exclusive access for the requesting processor, it is IMPLEMENTATION DEFINED whether the store succeeds or not:
 - if the store succeeds a status value of 0 is returned to a register, otherwise a value of 1 is returned
 - if the global monitor state machine for the processor was in the Exclusive Access state before the Store-Exclusive it is IMPLEMENTATION DEFINED whether that state machine transitions to the Open Access state.

The Store-Exclusive instruction defines the register to which the status value is returned.

In a shared memory system, the global monitor implements a separate state machine for each processor in the system. The state machine for accesses to Shareable memory by processor (n) can respond to all the Shareable memory accesses visible to it. This means it responds to:

- accesses generated by the associated processor (n)
- accesses generated by the other observers in the shareability domain of the memory location (!n).

In a shared memory system, the global monitor implements a separate state machine for each observer that can generate a Load-Exclusive or a Store-Exclusive in the system.

Figure A3-3 on page A3-18 shows the state machine for processor(n) in a global monitor. Table A3-7 on page A3-19 shows the effect of each of the operations shown in the figure.

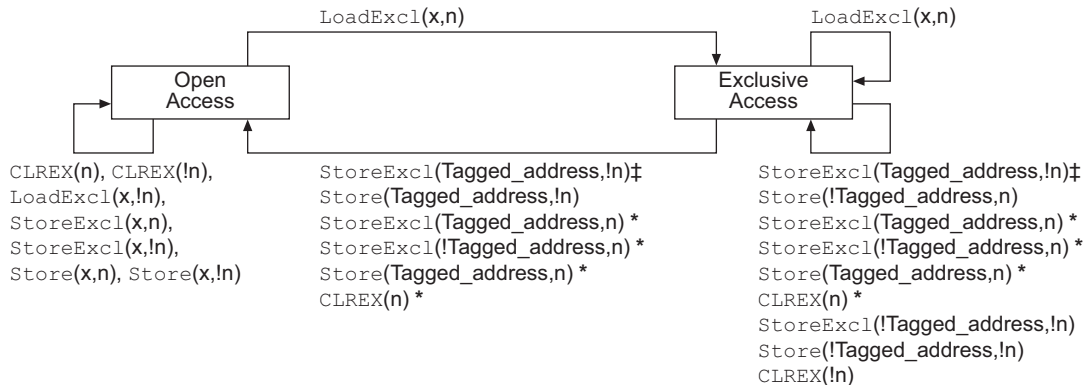

‡ $StoreExcl(Tagged_Address,!n)$ clears the monitor only if the $StoreExcl$ updates memory

Operations marked * are possible alternative IMPLEMENTATION DEFINED options.

In the diagram: $LoadExcl$ represents any Load-Exclusive instruction

$StoreExcl$ represents any Store-Exclusive instruction

$Store$ represents any other store instruction.

Any $LoadExcl$ operation updates the tagged address to the most significant bits of the address x used for the operation. For more information see the section *Size of the tagged memory block*.

Figure A3-3 Global monitor state machine diagram for processor(n) in a multiprocessor system

Note

For the global monitor state machine, as shown in Figure A3-3:

- Whether a Store-Exclusive successfully updates memory or not depends on whether the address accessed matches the tagged Shareable memory address for the processor issuing the Store-Exclusive instruction. For this reason, Figure A3-3 and Table A3-7 on page A3-19 only show how the (!n) entries cause state transitions of the state machine for processor(n).
- An Load-Exclusive can only update the tagged Shareable memory address for the processor issuing the Load-Exclusive instruction.
- The effect of the CLREX instruction on the global monitor is IMPLEMENTATION DEFINED.
- It is IMPLEMENTATION DEFINED:
 - whether a modification to a non-shareable memory location can cause a global monitor to transition from Exclusive Access to Open Access state
 - whether a Load-Exclusive to a non-shareable memory location can cause a global monitor to transition from Open Access to Exclusive Access state.

Table A3-7 shows the effect of the operations shown in Figure A3-3 on page A3-18.

Table A3-7 Effect of load/store operations on global monitor for processor(n)

Initial state ^a	Operation ^b	Effect	Final state ^a
Open	CLREX(n), CLREX(!n)	None	Open
	StoreExc1(x,n)	Does not update memory, returns status 1	Open
	LoadExc1(x,!n)	Loads value from memory, no effect on tag address for processor(n)	Open
	StoreExc1(x,!n)	Depends on state machine and tag address for processor issuing STREX ^c	Open
	Store(x,n), Store(x,!n)	Updates memory, no effect on monitor	Open
	LoadExc1(x,n)	Loads value from memory, tags address x	Exclusive
Exclusive	LoadExc1(x,n)	Loads value from memory, tags address x	Exclusive
	CLREX(n)	None. Effect on the final state is IMPLEMENTATION DEFINED.	Exclusive ^e Open ^e
	CLREX(!n)	None	Exclusive
	StoreExc1(t,!n)	Updates memory, returns status 0 ^c	Open
		Does not update memory, returns status 1 ^c	Exclusive
	StoreExc1(t,n)	Updates memory, returns status 0 ^d	Open Exclusive
		Updates memory, returns status 0 ^e	Open Exclusive
	StoreExc1(!t,n)	Updates memory, returns status 0 ^e	Open Exclusive
		Does not update memory, returns status 1 ^e	Open Exclusive
	StoreExc1(!t,!n)	Depends on state machine and tag address for processor issuing STREX	Exclusive

Table A3-7 Effect of load/store operations on global monitor for processor(n) (continued)

Initial state ^a	Operation ^b	Effect	Final state ^a
Exclusive	Store(t,n)	Updates memory	Exclusive ^c
	Store(t,!n)	Updates memory	Open ^c
	Store(!t,n), Store(!t,!n)	Updates memory, no effect on monitor	Exclusive

- a. Open = Open Access state, Exclusive = Exclusive Access state.
- b. In the table:
 LoadExcl represents any Load-Exclusive instruction
 StoreExcl represents any Store-Exclusive instruction
 Store represents any store operation other than a Store-Exclusive operation.
 t is the tagged address for processor(n), bits [31:a] of the address of the last Load-Exclusive instruction issued by processor(n), see *Tagging and the size of the tagged memory block*.
- c. The result of a STREX(x,!n) or a STREX(t,!n) operation depends on the state machine and tagged address for the processor issuing the STREX instruction. This table shows how each possible outcome affects the state machine for processor(n).
- d. After a successful STREX to the tagged address, the state of the state machine is IMPLEMENTATION DEFINED. However, this state has no effect on the subsequent operation of the global monitor.
- e. Effect is IMPLEMENTATION DEFINED. The table shows all permitted implementations.

A3.4.3 Tagging and the size of the tagged memory block

As stated in the footnotes to Table A3-6 on page A3-15 and Table A3-7 on page A3-19, when a Load-Exclusive instruction is executed, the resulting tag address ignores the least significant bits of the memory address.

$$\text{Tagged_address} = \text{Memory_address}[31:a]$$

The value of a in this assignment is IMPLEMENTATION DEFINED, between a minimum value of 3 and a maximum value of 11. For example, in an implementation where a == 4, a successful LDREX of address 0x000341B4 gives a tag value of bits [31:4] of the address, giving 0x000341B. This means that the four words of memory from 0x000341B0 to 0x000341BF are tagged for exclusive access.

The size of the tagged memory block, called the *Exclusives Reservation Granule*. The Exclusives Reservation Granule is IMPLEMENTATION DEFINED between:

- two words, in an implementation with a == 3
- 512 words, in an implementation with a == 11.

In some implementations the CTR identifies the Exclusives Reservation Granule, see:

- c0, *Cache Type Register (CTR)* on page B3-83 for a VMSA implementation
- c0, *Cache Type Register (CTR)* on page B4-34 for a PMSA implementation.

A3.4.4 Context switch support

After a context switch, software must ensure that the local monitor is in the Open Access state. This requires it to either:

- execute a CLREX instruction
- execute a dummy STREX to a memory address allocated for this purpose.

Note

- Using a dummy STREX for this purpose is backwards-compatible with the ARMv6 implementation of the exclusive operations. The CLREX instruction is introduced in ARMv6K.
 - Context switching is not an application level operation. However, this information is included here to complete the description of the exclusive operations.
-

The STREX or CLREX instruction following a context switch might cause a subsequent Store-Exclusive to fail, requiring a load ... store sequence to be replayed. To minimize the possibility of this happening, ARM recommends that the Store-Exclusive instruction is kept as close as possible to the associated Load-Exclusive instruction, see *Load-Exclusive and Store-Exclusive usage restrictions*.

A3.4.5 Load-Exclusive and Store-Exclusive usage restrictions

The Load-Exclusive and Store-Exclusive instructions are intended to work together, as a pair, for example a LDREX/STREX pair or a LDREXB/STREXB pair. As mentioned in *Context switch support*, ARM recommends that the Store-Exclusive instruction always follows within a few instructions of its associated Load-Exclusive instructions. To support different implementations of these functions, software must follow the notes and restrictions given here.

These notes describe use of an LDREX/STREX pair, but apply equally to any other Load-Exclusive/Store-Exclusive pair:

- The exclusives support a single outstanding exclusive access for each processor thread that is executed. The architecture makes use of this by not requiring an address or size check as part of the `IsExclusiveLocal()` function. If the target address of an STREX is different from the preceding LDREX in the same execution thread, behavior can be UNPREDICTABLE. As a result, an LDREX/STREX pair can only be relied upon to eventually succeed if they are executed with the same address. Where a context switch or exception might result in a change of execution thread, a CLREX instruction or a dummy STREX instruction must be executed to avoid unwanted effects, as described in *Context switch support*. Using an STREX in this way is the only occasion where software can program an STREX with a different address from the previously executed LDREX.
- An explicit store to memory can cause the clearing of exclusive monitors associated with other processors, therefore, performing a store between the LDREX and the STREX can result in a livelock situation. As a result, code must avoid placing an explicit store between an LDREX and an STREX in a single code sequence.

- If two STREX instructions are executed without an intervening LDREX the second STREX returns a status value of 1. This means that:
 - every STREX must have a preceding LDREX associated with it in a given thread of execution
 - it is not necessary for every LDREX to have a subsequent STREX.
- An implementation of the Load-Exclusive and Store-Exclusive instructions can require that, in any thread of execution, the transaction size of a Store-Exclusive is the same as the transaction size of the preceding Load-Exclusive that was executed in that thread. If the transaction size of a Store-Exclusive is different from the preceding Load-Exclusive in the same execution thread, behavior can be UNPREDICTABLE. As a result, an LDREX/STREX pair can only be relied upon to eventually succeed only if they have the same size. Where a context switch or exception might result in a change of execution thread, the software must execute a CLREX instruction or a dummy STREX instruction to avoid unwanted effects, as described in *Context switch support* on page A3-21. Using an STREX in this way is the only occasion where software can use a Store-Exclusive instruction with a different transaction size from the previously executed Load-Exclusive instruction.
- An implementation might clear an exclusive monitor between the LDREX and the STREX, without any application-related cause. For example, this might happen because of cache evictions. Code written for such an implementation must avoid having any explicit memory accesses or cache maintenance operations between the LDREX and STREX instructions.
- Implementations can benefit from keeping the LDREX and STREX operations close together in a single code sequence. This minimizes the likelihood of the exclusive monitor state being cleared between the LDREX instruction and the STREX instruction. Therefore, ARM strongly recommends a limit of 128 bytes between LDREX and STREX instructions in a single code sequence, for best performance.
- Implementations that implement coherent protocols, or have only a single master, might combine the local and global monitors for a given processor. The IMPLEMENTATION DEFINED and UNPREDICTABLE parts of the definitions in *Exclusive monitors operations* on page B2-35 are provided to cover this behavior.
- The architecture sets an upper limit of 2048 bytes on the size of a region that can be marked as exclusive. Therefore, for performance reasons, ARM recommends that software separates objects that will be accessed by exclusive accesses by at least 2048 bytes. This is a performance guideline rather than a functional requirement.
- LDREX and STREX operations must be performed only on memory with the Normal memory attribute.
- ~~The effect of Data Abort exceptions on the state of monitors is UNPREDICTABLE.~~ ARM recommends that abort handling code performs a CLREX instruction or a dummy STREX instruction to clear the monitor state.
- If the memory attributes for the memory being accessed by an LDREX/STREX pair are changed between the LDREX and the STREX, behavior is UNPREDICTABLE.



A3.4.6 Semaphores

The Swap (SWP) and Swap Byte (SWPB) instructions must be used with care to ensure that expected behavior is observed. Two examples are as follows:

1. A system with multiple bus masters that uses Swap instructions to implement semaphores that control interactions between different bus masters.
In this case, the semaphores must be placed in an uncached region of memory, where any buffering of writes occurs at a point common to all bus masters using the mechanism. The Swap instruction then causes a locked read-write bus transaction.
2. A systems with multiple threads running on a uniprocessor that uses the Swap instructions to implement semaphores that control interaction of the threads.
In this case, the semaphores can be placed in a cached region of memory, and a locked read-write bus transaction might or might not occur. The Swap and Swap Byte instructions are likely to have better performance on such a system than they do on a system with multiple bus masters such as that described in example 1.

Note

From ARMv6, use of the Swap and Swap Byte instructions is deprecated. All new software should use the Load-Exclusive and Store-Exclusive synchronization primitives described in *Synchronization and semaphores* on page A3-12, for example LDREX and STREX.

A3.4.7 Synchronization primitives and the memory order model

The synchronization primitives follow the memory order model of the memory type accessed by the instructions. For this reason:

- Portable code for claiming a spin-lock must include a *Data Memory Barrier* (DMB) operation, performed by a DMB instruction, between claiming the spin-lock and making any access that makes use of the spin-lock.
- Portable code for releasing a spin-lock must include a DMB instruction before writing to clear the spin-lock.

This requirement applies to code using:

- the Load-Exclusive/Store-Exclusive instruction pairs, for example LDREX/STREX
- the deprecated synchronization primitives, SWP/SWPB.

A3.4.8 Use of WFE and SEV instructions by spin-locks

ARMv7 and ARMv6K provide Wait For Event and Send Event instructions, WFE and SEV, that can assist with reducing power consumption and bus contention caused by processors repeatedly attempting to obtain a spin-lock. These instructions can be used at application level, but a complete understanding of what they do depends on system-level understanding of exceptions. They are described in *Wait For Event and Send Event* on page B1-44.

A3.5 Memory types and attributes and the memory order model

ARMv6 defined a set of memory attributes with the characteristics required to support the memory and devices in the system memory map. In ARMv7 this set of attributes is extended by the addition of the Outer Shareable attribute for Normal memory.

Note

Whether an ARMv7 implementation ~~supports the Outer Shareable memory attribute~~ is IMPLEMENTATION DEFINED.



The ordering of accesses for regions of memory, referred to as the memory order model, is defined by the memory attributes. This model is described in the following sections:

- *Memory types*
- *Summary of ARMv7 memory attributes* on page A3-25
- *Atomicity in the ARM architecture* on page A3-26
- *Normal memory* on page A3-28
- *Device memory* on page A3-33
- *Strongly-ordered memory* on page A3-34
- *Memory access restrictions* on page A3-35
- *Backwards compatibility* on page A3-37
- *The effect of the Security Extensions* on page A3-37.

A3.5.1 Memory types

For each memory region, the most significant memory attribute specifies the memory type. There are three mutually exclusive memory types:

- Normal
- Device
- Strongly-ordered.

Normal and Device memory regions have additional attributes.

Usually, memory used for program code and for data storage is Normal memory. Examples of Normal memory technologies are:

- programmed Flash ROM

Note

During programming, Flash memory can be ordered more strictly than Normal memory.

- ROM
- SRAM
- DRAM and DDR memory.

System peripherals (I/O) generally conform to different access rules to Normal memory. Examples of I/O accesses are:

- FIFOs where consecutive accesses
 - add queued values on write accesses
 - remove queued values on read accesses.
- interrupt controller registers where an access can be used as an interrupt acknowledge, changing the state of the controller itself
- memory controller configuration registers that are used to set up the timing and correctness of areas of Normal memory
- memory-mapped peripherals, where accessing a memory location can cause side effects in the system.

In ARMv7, regions of the memory map for these accesses are defined as Device or Strongly-ordered memory. To ensure system correctness, access rules for Device and Strongly-ordered memory are more restrictive than those for Normal memory:

- both read and write accesses can have side effects
- accesses must not be repeated, for example, on return from an exception
- the number, order and sizes of the accesses must be maintained.

In addition, for Strongly-ordered memory, all memory accesses are strictly ordered to correspond to the program order of the memory access instructions.

A3.5.2 Summary of ARMv7 memory attributes

Table A3-8 summarizes the memory attributes. For more information about these attributes see:

- *Normal memory* on page A3-28 and *Shareable attribute for Device memory regions* on page A3-34, for the *shareability* attribute
- *Write-Through Cacheable, Write-Back Cacheable and Non-cacheable Normal memory* on page A3-32, for the *cacheability* attribute.

Table A3-8 Memory attribute summary

Memory type attribute	Shareability	Other attributes	Description
Strongly-ordered	-	-	All memory accesses to Strongly-ordered memory occur in program order. All Strongly-ordered regions are assumed to be Shareable.

Table A3-8 Memory attribute summary (continued)

Memory type attribute	Shareability	Other attributes	Description
Device	Shareable	-	Intended to handle memory-mapped peripherals that are shared by several processors.
	Non-shareable	-	Intended to handle memory-mapped peripherals that are used only by a single processor.
Normal	Outer Shareable	Cacheability, one of: ^a Non-cacheable Write-Through Cacheable Write-Back Write-Allocate Cacheable Write-Back no Write-Allocate Cacheable	The Outer Shareable attribute qualifies the Shareable attribute for Normal memory regions and enables two levels of Normal memory sharing. ^b
	Inner Shareable	Cacheability, one of: ^a Non-cacheable Write-Through Cacheable Write-Back Write-Allocate Cacheable Write-Back no Write-Allocate Cacheable	Intended to handle Normal memory that is shared between several processors.
	Non-shareable	Cacheability, one of: ^a Non-cacheable Write-Through Cacheable Write-Back Write-Allocate Cacheable Write-Back no Write-Allocate Cacheable	Intended to handle Normal memory that is used by only a single processor.

a. The cacheability attribute is defined independently for inner and outer cache regions.

b. ~~The significance of the Outer Shareable attribute~~ is IMPLEMENTATION DEFINED.



A3.5.3 Atomicity in the ARM architecture

Atomicity is a feature of memory accesses, described as *atomic* accesses. The ARM architecture description refers to two types of atomicity, defined in:

- *Single-copy atomicity* on page A3-27
- *Multi-copy atomicity* on page A3-28.

Single-copy atomicity

A read or write operation is *single-copy atomic* if the following conditions are both true:

- After any number of write operations to an operand, the value of the operand is the value written by one of the write operations. It is impossible for part of the value of the operand to come from one write operation and another part of the value to come from a different write operation.
- When a read operation and a write operation are made to the same operand, the value obtained by the read operation is one of:
 - the value of the operand before the write operation
 - the value of the operand after the write operation.

It is never the case that the value of the read operation is partly the value of the operand before the write operation and partly the value of the operand after the write operation.

In ARMv7, the single-copy atomic processor accesses are:

- all byte accesses
- all halfword accesses to halfword-aligned locations
- all word accesses to word-aligned locations
- memory accesses caused by LDREXD and STREXD instructions to doubleword-aligned locations.

LDM, LDC, LDC2, LDRD, STM, STC, STC2, STRD, PUSH, POP, RFE, SRS, VLDM, VLDR, VSTM, and VSTR instructions are executed as a sequence of word-aligned word accesses. Each 32-bit word access is guaranteed to be single-copy atomic. A subsequence of two or more word accesses from the sequence might not exhibit single-copy atomicity.

Advanced SIMD element and structure loads and stores are executed as a sequence of accesses of the element or structure size. The element accesses are single-copy atomic if and only if both:

- the element size is 32 bits, or smaller
- the elements are naturally aligned.

Accesses to 64-bit elements or structures that are at least word-aligned are executed as a sequence of 32-bit accesses, each of which is single-copy atomic. Subsequences of two or more 32-bit accesses from the sequence might not be single-copy atomic.

When an access is not single-copy atomic, it is executed as a sequence of smaller accesses, each of which is single-copy atomic, at least at the byte level.

If an instruction is executed as a sequence of accesses according to these rules, some exceptions can be taken in the sequence and cause execution of the instruction to be abandoned. These exceptions are:

- synchronous Data Abort exceptions
- if low interrupt latency configuration is selected and the accesses are to Normal memory, see *Low interrupt latency configuration* on page B1-43:
 - IRQ interrupts
 - FIQ interrupts
 - asynchronous aborts.

If any of these exceptions are returned from using their preferred exception return, the instruction that generated the sequence of accesses is re-executed and so any accesses that had already been performed before the exception was taken are repeated.

———— **Note** —————

The exception behavior for these multiple access instructions means they are not suitable for use for writes to memory for the purpose of software synchronization.

For implicit accesses:

- Cache linefills and evictions have no effect on the single-copy atomicity of explicit transactions or instruction fetches.
- Instruction fetches are single-copy atomic for each instruction fetched.

———— **Note** —————

32-bit Thumb instructions are fetched as two 16-bit items.

- Translation table walks are performed as 32-bit accesses aligned to 32 bits, each of which is single-copy atomic.

Multi-copy atomicity

In a multiprocessing system, writes to a memory location are *multi-copy atomic* if the following conditions are both true:

- All writes to the same location are *serialized*, meaning they are observed in the same order by all observers, although some observers might not observe all of the writes.
- A read of a location does not return the value of a write until all observers observe that write.

Writes to Normal memory are not multi-copy atomic.

All writes to Device and Strongly-ordered memory that are single-copy atomic are also multi-copy atomic.

All write accesses to the same location are serialized. Write accesses to Normal memory can be repeated up to the point that another write to the same address is observed.

For Normal memory, serialization of writes does not prohibit the merging of writes.

A3.5.4 Normal memory

Normal memory is idempotent, meaning that it exhibits the following properties:

- read accesses can be repeated with no side effects
- repeated read accesses return the last value written to the resource being read
- read accesses can prefetch additional memory locations with no side effects

- write accesses can be repeated with no side effects, ~~provided that the contents of the location are unchanged between the repeated writes~~
- unaligned accesses can be supported
- accesses can be merged before accessing the target memory system.



Normal memory can be read/write or read-only, and a Normal memory region is defined as being either Shareable or Non-shareable. In a VMSA implementation, ~~Shareable Normal memory can be either Inner Shareable or Outer Shareable.~~ In a PMSA implementation, no distinction is made between Inner Shareable and Outer Shareable regions.



The Normal memory type attribute applies to most memory used in a system.

Accesses to Normal Memory have a weakly consistent model of memory ordering. See a standard text describing memory ordering issues for a description of weakly consistent memory models, for example chapter 2 of *Memory Consistency Models for Shared Memory-Multiprocessors*, Kourosh Gharachorloo, Stanford University Technical Report CSL-TR-95-685. In general, for Normal memory, barrier operations are required where the order of memory accesses observed by other observers must be controlled. This requirement applies regardless of the cacheability and shareability attributes of the Normal memory region.

The ordering requirements of accesses described in *Ordering requirements for memory accesses* on page A3-45 apply to all explicit accesses.

An instruction that generates a sequence of accesses as described in *Atomicity in the ARM architecture* on page A3-26 might be abandoned as a result of an exception being taken during the sequence of accesses. On return from the exception the instruction is restarted, and therefore one or more of the memory locations might be accessed multiple times. This can result in repeated write accesses to a location that has been changed between the write accesses.

The architecture permits speculative accesses to memory locations marked as Normal if the access permissions and domain permit an access to the locations.

A Normal memory region has shareability attributes that define the data coherency properties of the region. These attributes do not affect the coherency requirements of:

- instruction fetches, see *Instruction coherency issues* on page A3-53
- translation table walks, if supported, in the base ARMv7 architecture and in versions of the architecture before ARMv7, see *TLB maintenance operations and the memory order model* on page B3-59.

Non-shareable Normal memory

For a Normal memory region, the Non-shareable attribute identifies Normal memory that is likely to be accessed only by a single processor.

A region of Normal memory with the Non-shareable attribute does not have any requirement to make data accesses by different observers coherent, unless the memory is non-cacheable. If other observers share the memory system, software must use cache maintenance operations if the presence of caches might lead to coherency issues when communicating between the observers. This cache maintenance requirement is in addition to the barrier operations that are required to ensure memory ordering.

For Non-shareable Normal memory, the Load-Exclusive and Store-Exclusive synchronization primitives do not take account of the possibility of accesses by more than one observer.

Shareable, Inner Shareable, and Outer Shareable Normal memory

For Normal memory, the Shareable and Outer Shareable memory attributes describe Normal memory that is expected to be accessed by multiple processors or other system masters:

- In a VMSA implementation, Normal memory that has the Shareable attribute but not the Outer Shareable attribute assigned is described as having the Inner Shareable attribute.
- In a PMSA implementation, no distinction is made between Inner Shareable and Outer Shareable Normal memory, and you cannot assign the Outer Shareable attribute to Normal memory regions.

A region of Normal memory with the Shareable attribute is one for which data accesses to memory by different observers within the same shareability domain are coherent.

The Outer Shareable attribute is introduced in ARMv7, and can be applied only to a Normal memory region in a VMSA implementation that has the Shareable attribute assigned. It creates three levels of shareability for a Normal memory region:

Non-shareable

A Normal memory region that does not have the Shareable attribute assigned.

Inner Shareable

A Normal memory region that has the Shareable attribute assigned, but not the Outer Shareable attribute.

Outer Shareable

A Normal memory region that has both the Shareable and the Outer Shareable attributes assigned.

These attributes can be used to define sets of observers for which the shareability attributes make the data or unified caches transparent for data accesses. The sets of observers that are affected by the shareability attributes are described as *shareability domains*. The details of the use of these attributes are system-specific. Example A3-1 on page A3-31 shows how they might be used:

Example A3-1 Use of shareability attributes

In a VMSA implementation, a particular sub-system with two clusters of processors has the requirement that:

- in each cluster, the data or unified caches of the processors in the cluster are transparent for all data accesses with the Inner Shareable attribute
- however, between the two clusters, the caches:
 - are not transparent for data accesses that have only the Inner Shareable attribute
 - are transparent for data accesses that have the Outer Shareable attribute.

In this system, each cluster is in a different shareability domain for the Inner Shareable attribute, but all components of the sub-system are in the same shareability domain for the Outer Shareable attribute.

A system might implement two such sub-systems. If the data or unified caches of one subsystem are not transparent to the accesses from the other subsystem, this system has two Outer Shareable shareability domains.

Having two levels of shareability attribute means you can reduce the performance and power overhead for shared memory regions that do not need to be part of the Outer Shareable shareability domain.

~~Whether an ARMv7 implementation supports the Outer Shareable attribute is IMPLEMENTATION DEFINED. If the Outer Shareable attribute is supported, its significance in the implementation is IMPLEMENTATION DEFINED.~~



For Shareable Normal memory, the Load-Exclusive and Store-Exclusive synchronization primitives take account of the possibility of accesses by more than one observer in the same Shareability domain.

———— **Note** ————

The Shareable concept enables system designers to specify the locations in Normal memory that must have coherency requirements. However, to facilitate porting of software, software developers must not assume that specifying a memory region as Non-shareable permits software to make assumptions about the incoherency of memory locations between different processors in a shared memory system. Such assumptions are not portable between different multiprocessing implementations that make use of the Shareable concept. Any multiprocessing implementation might implement caches that, inherently, are shared between different processing elements.

Write-Through Cacheable, Write-Back Cacheable and Non-cacheable Normal memory

In addition to being Outer Shareable, Inner Shareable or Non-shareable, each region of Normal memory can be marked as being one of:

- Write-Through Cacheable
- Write-Back Cacheable, with an additional qualifier that marks it as one of:
 - Write-Back, Write-Allocate
 - Write-Back, no Write-Allocate
- Non-cacheable.

If the same memory locations are marked as having different cacheability attributes, for example by the use of aliases in a virtual to physical address mapping, behavior is UNPREDICTABLE.

The cacheability attributes provide a mechanism of coherency control with observers that lie outside the shareability domain of a region of memory. In some cases, the use of Write-Through Cacheable or Non-cacheable regions of memory might provide a better mechanism for controlling coherency than the use of hardware coherency mechanisms or the use of cache maintenance routines. To this end, the architecture requires the following properties for Non-cacheable or Write-Through Cacheable memory:

- a completed write to a memory location that is Non-cacheable or Write-Through Cacheable for a level of cache made by an observer accessing the memory system inside the level of cache is visible to all observers accessing the memory system outside the level of cache without the need of explicit cache maintenance
- a completed write to a memory location that is Non-cacheable for a level of cache made by an observer accessing the memory system outside the level of cache is visible to all observers accessing the memory system inside the level of cache without the need of explicit cache maintenance.

———— Note —————

Implementations can also use the cacheability attributes to provide a performance hint regarding the performance benefit of caching. For example, it might be known to a programmer that a piece of memory is not going to be accessed again and would be better treated as Non-cacheable. The distinction between Write-Back Write-Allocate and Write-Back no Write-Allocate memory exists only as a hint for performance.

The ARM architecture provides independent cacheability attributes for Normal memory for two conceptual levels of cache, the *inner* and the *outer* cache. The relationship between these conceptual levels of cache and the implemented physical levels of cache is IMPLEMENTATION DEFINED, and can differ from the boundaries between the Inner and Outer Shareability domains. However:

- inner refers to the innermost caches, and always includes the lowest level of cache
- no cache controlled by the Inner cacheability attributes can lie outside a cache controlled by the Outer cacheability attributes
- an implementation might not have any outer cache.

Example A3-2 to Example A3-4 describe the three possible ways of implementing a system with three levels of cache, L1 to L3. L1 is the level closest to the processor, see *Memory hierarchy* on page A3-52.

Example A3-2 Implementation with two inner and one outer cache levels

Implement the three levels of cache in the system, L1 to L3, with:

- the Inner cacheability attribute applied to L1 and L2 cache
 - the Outer cacheability attribute applied to L3 cache.
-

Example A3-3 Implementation with three inner and no outer cache levels

Implement the three levels of cache in the system, L1 to L3, with the Inner cacheability attribute applied to L1, L2, and L3 cache. Do not use the Outer cacheability attribute.

Example A3-4 Implementation with one inner and two outer cache levels

Implement the three levels of cache in the system, L1 to L3, with:

- the Inner cacheability attribute applied to L1 cache
 - the Outer cacheability attribute applied to L2 and L3 cache.
-

A3.5.5 Device memory

The Device memory type attribute defines memory locations where an access to the location can cause side effects, or where the value returned for a load can vary depending on the number of loads performed. Memory-mapped peripherals and I/O locations are examples of memory regions normally marked as being Device memory.

For explicit accesses from the processor to memory marked as Device:

- all accesses occur at their program size
- the number of accesses is the number specified by the program.

An implementation must not ~~repeat an access to a Device memory location if the program has only one access to that location. In other words, accesses to Device memory locations are not restartable.~~



The architecture does not permit speculative accesses to memory marked as Device.

The architecture permits an Advanced SIMD element or structure load instruction to access bytes in Device memory that are not explicitly accessed by the instruction, provided the bytes accessed are within a 16-byte window, aligned to 16-bytes, that contains at least one byte that is explicitly accessed by the instruction.

Address locations marked as Device are never held in a cache.

All explicit accesses to Device memory must comply with the ordering requirements of accesses described in *Ordering requirements for memory accesses* on page A3-45.

An instruction that generates a sequence of accesses as described in *Atomicity in the ARM architecture* on page A3-26 might be abandoned as a result of an exception being taken during the sequence of accesses. On return from the exception the instruction is restarted, and therefore one or more of the memory locations might be accessed multiple times. This can result in repeated write accesses to a location that has been changed between the write accesses.

———— **Note** ————

Do not use an instruction that generates a sequence of accesses to access Device memory if the instruction might generate an ~~abort~~ on any access other than the first one.



Any unaligned access that is not faulted by the alignment restrictions and accesses Device memory has UNPREDICTABLE behavior.

Shareable attribute for Device memory regions

Device memory regions can be given the Shareable attribute. This means that a region of Device memory can be described as either:

- Shareable Device memory
- Non-shareable Device memory.

Non-shareable Device memory is defined as only accessible by a single processor. An example of a system supporting Shareable and Non-shareable Device memory is an implementation that supports both:

- a local bus for its private peripherals
- system peripherals implemented on the main shared system bus.

Such a system might have more predictable access times for local peripherals such as watchdog timers or interrupt controllers. In particular, a specific address in a Non-shareable Device memory region might access a different physical peripheral for each processor.

A3.5.6 Strongly-ordered memory

The Strongly-ordered memory type attribute defines memory locations where an access to the location can cause side effects, or where the value returned for a load can vary depending on the number of loads performed. Examples of memory regions normally marked as being Strongly-ordered are memory-mapped peripherals and I/O locations.

For explicit accesses from the processor to memory marked as Strongly-ordered:

- all accesses occur at their program size
- the number of accesses is the number specified by the program.

An implementation must not ~~repeat an access to a Strongly-ordered memory location if the program has only one access to that location. In other words, accesses to Strongly-ordered memory locations are not restartable.~~



The architecture does not permit speculative accesses to memory marked as Strongly-ordered.

The architecture permits an Advanced SIMD element or structure load instruction to access bytes in Strongly-ordered memory that are not explicitly accessed by the instruction, provided the bytes accessed are within a 16-byte window, aligned to 16-bytes, that contains at least one byte that is explicitly accessed by the instruction.

Address locations in Strongly-ordered memory are not held in a cache, and are always treated as Shareable memory locations.

All explicit accesses to Strongly-ordered memory must correspond to the ordering requirements of accesses described in *Ordering requirements for memory accesses* on page A3-45.

An instruction that generates a sequence of accesses as described in *Atomicity in the ARM architecture* on page A3-26 might be abandoned as a result of an exception being taken during the sequence of accesses. On return from the exception the instruction is restarted, and therefore one or more of the memory locations might be accessed multiple times. This can result in repeated write accesses to a location that has been changed between the write accesses.

———— **Note** —————

Do not use an instruction that generates a sequence of accesses to access Strongly-ordered memory if the instruction might generate ~~an abort~~ on any access other than the first one.



Any unaligned access that is not faulted by the alignment restrictions and accesses Strongly-ordered memory has UNPREDICTABLE behavior.

———— **Note** —————

See *Ordering of instructions that change the CPSR interrupt masks* on page AppxG-8 for additional requirements that apply to accesses to Strongly-ordered memory in ARMv6.

A3.5.7 Memory access restrictions

The following restrictions apply to memory accesses:

- For any access X, the bytes accessed by X must all have the same memory type attribute, otherwise the behavior of the access is UNPREDICTABLE. That is, an unaligned access that spans a boundary between different memory types is UNPREDICTABLE.
- For any two memory accesses X and Y that are generated by the same instruction, the bytes accessed by X and Y must all have the same memory type attribute, otherwise the results are UNPREDICTABLE. For example, an LDC, LDM, LDRD, STC, STM, or STRD that spans a boundary between Normal and Device memory is UNPREDICTABLE.
- An instruction that generates an unaligned memory access to Device or Strongly-ordered memory is UNPREDICTABLE.

- To ensure access rules are maintained, an instruction that causes multiple accesses to Device or Strongly-ordered memory must not cross a 4KB address boundary, otherwise the effect is UNPREDICTABLE. For this reason, it is important that an access to a volatile memory device is not made using a single instruction that crosses a 4KB address boundary.

ARM expects this restriction to impose constraints on the placing of volatile memory devices in the memory map of a system, rather than expecting a compiler to be aware of the alignment of memory accesses.

- For instructions that generate accesses to Device or Strongly-ordered memory, implementations must not change the sequence of accesses specified by the pseudocode of the instruction. This includes not changing:
 - how many accesses there are
 - the time order of the accesses
 - the data sizes and other properties of each access.



In addition, processor implementations expect any attached memory system to be able to identify the memory type of an accesses, and to obey similar restrictions with regard to the number, time order, data sizes and other properties of the accesses.

Exceptions to this rule are:

- An implementation of a processor can break this rule, provided that the information it supplies to the memory system enables the original number, time order, and other details of the accesses to be reconstructed. In addition, the implementation must place a requirement on attached memory systems to do this reconstruction when the accesses are to Device or Strongly-ordered memory.

For example, an implementation with a 64-bit bus might pair the word loads generated by an LDM into 64-bit accesses. This is because the instruction semantics ensure that the 64-bit access is always a word load from the lower address followed by a word load from the higher address. However the implementation must permit the memory systems to unpack the two word loads when the access is to Device or Strongly-ordered memory.
 - Any implementation technique that produces results that cannot be observed to be different from those described above is legitimate.
 - An Advanced SIMD element or structure load instruction can access bytes in Device or Strongly-ordered memory that are not explicitly accessed by the instruction, provided the bytes accessed are within a 16-byte window, aligned to 16-bytes, that contains at least one byte that is explicitly accessed by the instruction.
- Any multi-access instruction that loads or stores the PC must access only Normal memory. If the instruction accesses Device or Strongly-ordered memory the result is UNPREDICTABLE. There is one exception to this restriction. In the VMSA architecture, when the MMU is disabled any multi-access instruction that loads or stores the PC functions correctly, see *Enabling and disabling the MMU* on page B3-5.
 - Any instruction fetch must access only Normal memory. If it accesses Device or Strongly-ordered memory, the result is UNPREDICTABLE. For example, instruction fetches must not be performed to an area of memory that contains read-sensitive devices, because there is no ordering requirement between instruction fetches and explicit accesses.

- Behavior is UNPREDICTABLE if the same memory location:
 - is marked as Shareable Normal and Non-shareable Normal
 - is marked as having different memory types (Normal, Device, or Strongly-ordered)
 - is marked as having different cacheability attributes
 - is marked as being Shareable Device and Non-shareable Device memory.

Such memory marking contradictions can occur, for example, by the use of aliases in a virtual to physical address mapping.

~~Before ARMv6, it is IMPLEMENTATION DEFINED whether a low interrupt latency mode is supported. From ARMv6, low interrupt latency support is controlled by the SCTL.R.FI bit. It is IMPLEMENTATION DEFINED whether multi-access instructions behave correctly in low interrupt latency configurations.~~



A3.5.8 Backwards compatibility

From ARMv6, the memory attributes are significantly different from those in previous versions of the architecture. Table A3-9 shows the interpretation of the earlier memory types in the light of this definition.

Table A3-9 Backwards compatibility

Previous architectures	ARMv6 and ARMv7 attribute
NCNB (Non-cacheable, Non-bufferable)	Strongly-ordered
NCB (Non-cacheable, Bufferable)	Shareable Device
Write-Through Cacheable, Bufferable	Non-shareable Normal, Write-Through Cacheable
Write-Back Cacheable, Bufferable	Non-shareable Normal, Write-Back Cacheable

A3.5.9 The effect of the Security Extensions

The Security Extensions can be included as part of an ARMv7-A implementation, with a VMSA. They provide two distinct 4GByte virtual memory spaces:

- a Secure virtual memory space
- a Non-secure virtual memory space.

The Secure virtual memory space is accessed by memory accesses in the Secure state, and the Non-secure virtual memory space is accessed by memory accesses in the Non-secure state.

By providing different virtual memory spaces, the Security Extensions permit memory accesses made from the Non-secure state to be distinguished from those made from the Secure state.

A3.6 Access rights

ARMv7 includes additional attributes for memory regions, that enable:

- Data accesses to be restricted, based on the privilege of the access. See *Privilege level access controls for data accesses*.
- Instruction fetches to be restricted, based on the privilege of the process or thread making the fetch. See *Privilege level access controls for instruction accesses*.
- On a system that implements the Security Extensions, accesses to be restricted to memory accesses with the Secure memory attribute. See *Memory region security status* on page A3-39.

A3.6.1 Privilege level access controls for data accesses

The memory attributes can define that a memory region is:

- not accessible to any accesses
- accessible only to Privileged accesses
- accessible to Privileged and Unprivileged accesses.

The access privilege level is defined separately for explicit read and explicit write accesses. However, a system that defines the memory attributes is not required to support all combinations of memory attributes for read and write accesses.

A Privileged access is an access made during privileged execution, as a result of a load or store operation other than LDRT, STRT, LDRBT, STRBT, LDRHT, STRHT, LDRSHT, or LDRSBT.

An Unprivileged access is an access made as a result of load or store operation performed in one of these cases:

- when the processor is in an unprivileged mode
- when the processor is in any mode and the access is made as a result of a LDRT, STRT, LDRBT, STRBT, LDRHT, STRHT, LDRSHT, or LDRSBT instruction.

A Data Abort exception is generated if the processor attempts a data access that the access rights do not permit. For example, a Data Abort exception is generated if the processor is in unprivileged mode and attempts to access a memory region that is marked as only accessible to Privileged accesses.

A3.6.2 Privilege level access controls for instruction accesses

Memory attributes can define that a memory region is:

- Not accessible for execution
- Accessible for execution by Privileged processes only
- Accessible for execution by Privileged and Unprivileged processes.

To define the instruction access rights to a memory region, the memory attributes describe, separately, for the region:

- its read access rights, see *Privilege level access controls for data accesses*

- whether it is *suitable for execution*.

For example, a region that is accessible for execution by Privileged processes only has the memory attributes:

- accessible only to Privileged read accesses
- suitable for execution.

This means there is some linkage between the memory attributes that define the accessibility of a region to explicit memory accesses, and those that define that a region can be executed.

A memory fault occurs if a processor attempts to execute code from a memory location with attributes that do not permit code execution.

A3.6.3 Memory region security status

An additional memory attribute determines whether the memory region is Secure or Non-secure in an ARMv7-A system that implements the Security Extensions. When the Security Extensions are implemented, this attribute is checked by the system hardware to ensure that a region of memory that is designated as Secure by the system hardware is not accessed by memory accesses with the Non-secure memory attribute. For more information, see *Memory region attributes* on page B3-32.

A3.7 Virtual and physical addressing

ARMv7 provides three alternative architectural profiles, ARMv7-A, ARMv7-R and ARMv7-M. Each of the profiles specifies a different memory system. This manual describes two of these profiles:

ARMv7-A profile

The ARMv7-A memory system incorporates a *Memory Management Unit* (MMU), controlled by CP15 registers. The memory system supports virtual addressing, with the MMU performing virtual to physical address translation, in hardware, as part of program execution.

ARMv7-R profile

The ARMv7-R memory system incorporates a *Memory Protection Unit* (MPU), controlled by CP15 registers. The MPU does not support virtual addressing.

At the application level, the difference between the ARMv7-A and ARMv7-R memory systems is transparent. Regardless of which profile is implemented, an application accesses the memory map described in *Address space* on page A3-2, and the implemented memory system makes the features described in this chapter available to the application.

For a system-level description of the ARMv7-A and ARMv7-R memory models see:

- Chapter B2 *Common Memory System Architecture Features*
- Chapter B3 *Virtual Memory System Architecture (VMSA)*
- Chapter B4 *Protected Memory System Architecture (PMSA)*.

Note

This manual does not describe the ARMv7-M profile. For details of this profile see:

- *ARMv7-M Architecture Application Level Reference Manual*, for an application-level description
 - *ARMv7-M Architecture Reference Manual*, for a full description.
-

A3.8 Memory access order

ARMv7 provides a set of three memory types, Normal, Device, and Strongly-ordered, with well-defined memory access properties.

The ARMv7 application-level view of the memory attributes is described in:

- *Memory types and attributes and the memory order model* on page A3-24
- *Access rights* on page A3-38.

When considering memory access ordering, an important feature of the ARMv6 memory model is the *Shareable* memory attribute, that indicates whether a region of memory can be shared between multiple processors, and therefore requires an appearance of cache transparency in the ordering model.

The key issues with the memory order model depend on the target audience:

- For software programmers, considering the model at the application level, the key factor is that for accesses to Normal memory barriers are required in some situations where the order of accesses observed by other observers must be controlled.
- For silicon implementers, considering the model at the system level, the Strongly-ordered and Device memory attributes place certain restrictions on the system designer in terms of what can be built and when to indicate completion of an access.

———— **Note** —————

Implementations remain free to choose the mechanisms required to implement the functionality of the memory model.

More information about the memory order model is given in the following subsections:

- *Reads and writes* on page A3-42
- *Ordering requirements for memory accesses* on page A3-45
- *Memory barriers* on page A3-47.

Additional attributes and behaviors relate to the memory system architecture. These features are defined in the system level section of this manual:

- Virtual memory systems based on an MMU, described in Chapter B3 *Virtual Memory System Architecture (VMSA)*.
- Protected memory systems based on an MPU, described in Chapter B4 *Protected Memory System Architecture (PMSA)*.
- Caches, described in *Caches* on page B2-3.

———— **Note** —————

In these system level descriptions, some attributes are described in relation to an MMU. In general, these descriptions can also be applied to an MPU based system.

A3.8.1 Reads and writes

Each memory access is either a read or a write. *Explicit* memory accesses are the memory accesses required by the function of an instruction. The following can cause memory accesses that are not explicit:

- instruction fetches
- cache loads and writebacks
- translation table walks.

Except where otherwise stated, the memory ordering requirements only apply to explicit memory accesses.

Reads

Reads are defined as memory operations that have the semantics of a load.

The memory accesses of the following instructions are reads:

- LDR, LDRB, LDRH, LDRSB, and LDRSH
- LDRT, LDRBT, LDRHT, LDRSBT, and LDRSHT
- LDREX, LDREXB, LDREXD, and LDREXH
- LDM, LDRD, POP, and RFE
- LDC, LDC2, VLDM, VLDR, VLD1, VLD2, VLD3, and VLD4
- the return of status values by STREX, STREXB, STREXD, and STREXH
- in the ARM instruction set only, SWP and SWPB
- in the Thumb instruction set only, TBB and TBH.

Hardware-accelerated opcode execution by the Jazelle extension can cause a number of reads to occur, according to the state of the operand stack and the implementation of the Jazelle hardware acceleration.

Writes

Writes are defined as memory operations that have the semantics of a store.

The memory accesses of the following instructions are Writes:

- STR, STRB, and STRH
- STRT, STRBT, and STRHT
- STREX, STREXB, STREXD, and STREXH
- STM, STRD, PUSH, and SRS
- STC, STC2, VSTM, VSTR, VST1, VST2, VST3, and VST4
- in the ARM instruction set only, SWP and SWPB.

Hardware-accelerated opcode execution by the Jazelle extension can cause a number of writes to occur, according to the state of the operand stack and the implementation of the Jazelle hardware acceleration.

Synchronization primitives

Synchronization primitives must ensure correct operation of system semaphores in the memory order model. The synchronization primitive instructions are defined as those instructions that are used to ensure memory synchronization:

- LDREX, STREX, LDREXB, STREXB, LDREXD, STREXD, LDREXH, STREXH.
- SWP, SWPB. Use of these instructions is deprecated from ARMv6.

Before ARMv6, support consisted of the SWP and SWPB instructions. ARMv6 introduced new Load-Exclusive and Store-Exclusive instructions LDREX and STREX, and deprecated using the SWP and SWPB instructions.

ARMv7 introduces:

- additional Load-Exclusive and Store-Exclusive instructions, LDREXB, LDREXD, LDREXH, STREXB, STREXD, and STREXH
- the Clear-Exclusive instruction CLREX
- the Load-Exclusive, Store-Exclusive and Clear-Exclusive instructions in the Thumb instruction set.

For details of the Load-Exclusive, Store-Exclusive and Clear-Exclusive instructions see *Synchronization and semaphores* on page A3-12.

The Load-Exclusive and Store-Exclusive instructions are supported to Shareable and Non-shareable memory. Non-shareable memory can be used to synchronize processes that are running on the same processor. Shareable memory must be used to synchronize processes that might be running on different processors.

Observability and completion

An *observer* is an agent in the system that can access memory. For a processor, the following mechanisms must be treated as independent observers:

- the mechanism that performs reads or writes to memory
- a mechanism that causes an instruction cache to be filled from memory or that fetches instructions to be executed directly from memory
- a mechanism that performs translation table walks.

The set of observers that can observe a memory access is defined by the system.

For all memory:

- ~~a write to a location in memory is said to be observed by an observer when a subsequent read of the location by the same observer will return the value written by the write~~
- ~~a write to a location in memory is said to be globally observed for a shareability domain when a subsequent read of the location by any observer in that shareability domain will return the value written by the write~~



- a read of a location in memory is said to be observed by an observer when a subsequent write to the location by the same observer will have no effect on the value returned by the read
- a read of a location in memory is said to be globally observed for a shareability domain when a subsequent write to the location by any observer in that shareability domain will have no effect on the value returned by the read.

Additionally, for Strongly-ordered memory:

- A read or write of a memory-mapped location in a peripheral that exhibits side-effects is said to be observed, and globally observed, only when the read or write:
 - meets the general conditions listed
 - can begin to affect the state of the memory-mapped peripheral
 - can trigger all associated side effects, whether they affect other peripheral devices, processors or memory.

For all memory, the completion rules are defined as:

- A read or write is complete for a shareability domain when all of the following are true:
 - the read or write is globally observed for that shareability domain
 - any translation table walks associated with the read or write are complete for that shareability domain.
- A translation table walk is complete for a shareability domain when the memory accesses associated with the translation table walk are globally observed for that shareability domain, and the TLB is updated.
- A cache, branch predictor or TLB maintenance operation is complete for a shareability domain when the effects of operation are globally observed for that shareability domain and any translation table walks that arise from the operation are complete for that shareability domain.

The completion of any cache, branch predictor and TLB maintenance operation includes its completion on all processors that are affected by both the operation and the DSB.

Side effect completion in Strongly-ordered and Device memory

The completion of a memory access in Strongly-ordered or Device memory is not guaranteed to be sufficient to determine that the side effects of the memory access are visible to all observers. The mechanism that ensures the visibility of side-effects of a memory accesses is IMPLEMENTATION DEFINED.

A3.8.2 Ordering requirements for memory accesses

ARMv7 and ARMv6 define access restrictions in the permitted ordering of memory accesses. These restrictions depend on the memory attributes of the accesses involved.

Two terms used in describing the memory access ordering requirements are:

Address dependency

An address dependency exists when the value returned by a read access is used to compute the virtual address of a subsequent read or write access. An address dependency exists even if the value read by the first read access does not change the virtual address of the second read or write access. This might be the case if the value returned is masked off before it is used, or if it has no effect on the predicted address value for the second access.

Control dependency

A control dependency exists when the data value returned by a read access is used to determine the condition code flags, and the values of the flags are used for condition code checking to determine the address of a subsequent read access. This address determination might be through conditional execution, or through the evaluation of a branch.

Figure A3-4 on page A3-46 shows the memory ordering between two explicit accesses A1 and A2, where A1 occurs before A2 in program order. The symbols used in the figure are as follows:

- < Accesses must be observed in program order, that is, A1 must be observed before A2.
- Accesses can be observed in any order, provided that the requirements of uniprocessor semantics, for example respecting dependencies between instructions in a single processor, are maintained.

The following additional restrictions apply to the ordering of memory accesses that have this symbol:

- If there is an address dependency then the two memory accesses are observed in program order by any observer in the common shareability domain of the two accesses.
This ordering restriction does not apply if there is only a control dependency between the two read accesses.
If there is both an address dependency and a control dependency between two read accesses the ordering requirements of the address dependency apply.
- If the value returned by a read access is used as data written by a subsequent write access, then the two memory accesses are observed in program order.
- It is impossible for an observer in the shareability domain of a memory location to observe a write access to that memory location if that location would not be written to in a sequential execution of a program.
- It is impossible for an observer in the shareability domain of a memory location to observe a write value written to that memory location if that value would not be written in a sequential execution of a program.

- It is impossible for an observer in the shareability domain of a memory location to observe two reads to the same memory location performed by the same observer in an order that would not occur in a sequential execution of a program.

In Figure A3-4, an access refers to a read or a write access to the specified memory type. For example, *Device access, Non-shareable* refers to a read or write access to Non-shareable Device memory.

A1 \ A2	Normal access	Device access		Strongly-ordered access
		Non-shareable	Shareable	
Normal access	-	-	-	-
Device access, Non-shareable	-	<	-	<
Device access, Shareable	-	-	<	<
Strongly-ordered access	-	<	<	<

Figure A3-4 Memory ordering restrictions

There are no ordering requirements for implicit accesses to any type of memory.

Program order for instruction execution

The program order of instruction execution is the order of the instructions in the control flow trace.

Explicit memory accesses in an execution can be either:

Strictly Ordered

Denoted by <. Must occur strictly in order.

Ordered

Denoted by <=. Can occur either in order or simultaneously.

Load/store multiple instructions, such as LDM, LDRD, STM, and STRD, generate multiple word accesses, each of which is a separate access for the purpose of determining ordering.

The rules for determining program order for two accesses A1 and A2 are:

If A1 and A2 are generated by two different instructions:

- A1 < A2 if the instruction that generates A1 occurs before the instruction that generates A2 in program order
- A2 < A1 if the instruction that generates A2 occurs before the instruction that generates A1 in program order.

If A1 and A2 are generated by the same instruction:

- If A1 and A2 are the load and store generated by a SWP or SWPB instruction:
 - A1 < A2 if A1 is the load and A2 is the store
 - A2 < A1 if A2 is the load and A1 is the store.

- In these descriptions:
 - an *LDM-class* instruction is any form of LDM, LDMDA, LDMDB, LDMIB, or POP instruction
 - an *LDC-class* instruction is an LDC, VLDM, or VLDR instruction
 - an *STM-class* instruction is any form of STM, STMDA, STMDB, STMIB, or PUSH instruction
 - an *STC-class* instruction is an STC, VSTM, or VSTR instruction.

If A1 and A2 are two word loads generated by an LDC-class or LDM-class instruction, or two word stores generated by an STC-class or STM-class instruction, excluding LDM-class and STM-class instructions with a register list that includes the PC:

- $A1 \leq A2$ if the address of A1 is less than the address of A2
- $A2 \leq A1$ if the address of A2 is less than the address of A1.

If A1 and A2 are two word loads generated by an LDM-class instruction with a register list that includes the PC or two word stores generated by an STM-class instruction with a register list that includes the PC, the program order of the memory accesses is not defined.

- If A1 and A2 are two word loads generated by an LDRD instruction or two word stores generated by an STRD instruction, the program order of the memory accesses is not defined.
- If A1 and A2 are load or store accesses generated by Advanced SIMD element or structure load/store instructions, the program order of the memory accesses is not defined.
- For any instruction or operation not explicitly mentioned in this section, if the single-copy atomicity rules described in *Single-copy atomicity* on page A3-27 mean the operation becomes a sequence of accesses, then the time-ordering of those accesses is not defined.

A3.8.3 Memory barriers

Memory barrier is the general term applied to an instruction, or sequence of instructions, used to force synchronization events by a processor with respect to retiring load/store instructions. The ARM architecture defines a number of memory barriers that provide a range of functionality, including:

- ordering of issued load/store instructions ~~to the programmers' model~~
- completion of preceding load/store instructions ~~to the programmers' model~~
- flushing of any instructions prefetched before the memory barrier operation.



ARMv7 and ARMv6 require three explicit memory barriers to support the memory order model described in this chapter. In ARMv7 the memory barriers are provided as instructions that are available in the ARM and Thumb instruction sets, and in ARMv6 the memory barriers are performed by CP15 register writes. The three memory barriers are:

- Data Memory Barrier, see *Data Memory Barrier (DMB)* on page A3-48
- Data Synchronization Barrier, see *Data Synchronization Barrier (DSB)* on page A3-49
- Instruction Synchronization Barrier, see *Instruction Synchronization Barrier (ISB)* on page A3-49.

Depending on the synchronization needed, a program might use memory barriers on their own, or it might use them in conjunction with cache and memory management maintenance operations that are only available in privileged modes.

The DMB and DSB memory barriers affect reads and writes to the memory system generated by load/store instructions and data or unified cache maintenance operations being executed by the processor. Instruction fetches or accesses caused by a hardware translation table access are not explicit accesses.

Data Memory Barrier (DMB)

The DMB instruction is a data memory barrier. The processor that executes the DMB instruction is referred to as the executing processor, Pe. The DMB instruction takes the *required shareability domain* and *required access types* as arguments. If the required shareability is *Full system* then the operation applies to all observers within the system.

A DMB creates two groups of memory accesses, Group A and Group B:

Group A Contains:

- All explicit memory accesses of the required access types from observers in the same required shareability domain as Pe that are observed by Pe before the DMB instruction. These accesses include any accesses of the required access types and required shareability domain performed by Pe.
- All loads of required access types from observers in the same required shareability domain as Pe that have been observed by any given observer, Py, in the same required shareability domain as Pe before Py has performed a memory access that is a member of Group A.

Group B Contains:

- All explicit memory accesses of the required access types by Pe that occur in program order after the DMB instruction.
- All explicit memory accesses of the required access types by any given observer Px in the same required shareability domain as Pe that can only occur after Px has observed a store that is a member of Group B.

Any observer with the same required shareability domain as Pe observes all members of Group A before it observes any member of Group B to the extent that those group members are required to be observed, as determined by the shareability and cacheability of the memory locations accessed by the group members. Where members of Group A and Group B access the same memory-mapped peripheral, all members of Group A will be visible at the memory-mapped peripheral before any members of Group B are visible at that peripheral.

Note

- A memory access might be in neither Group A nor Group B. The DMB does not affect the order of observation of such a memory access.
- The second part of the definition of Group A is recursive. Ultimately, membership of Group A derives from the observation by Py of a load before Py performs an access that is a member of Group A as a result of the first part of the definition of Group A.

- The second part of the definition of Group B is recursive. Ultimately, membership of Group B derives from the observation by any observer of an access by Pe that is a member of Group B as a result of the first part of the definition of Group B.

DMB only affects memory accesses. It has no effect on the ordering of any other instructions executing on the processor.

For details of the DMB instruction in the Thumb and ARM instruction sets see *DMB* on page A8-90.

Data Synchronization Barrier (DSB)

The DSB instruction is a special memory barrier, that synchronizes the execution stream with memory accesses. The DSB instruction takes the *required shareability domain* and *required access types* as arguments. If the required shareability is *Full system* then the operation applies to all observers within the system.

A DSB behaves as a DMB with the same arguments, and also has the additional properties defined here.

A DSB completes when both:

- all explicit memory accesses that are observed by Pe before the DSB is executed, are of the required access types, and are from observers in the same required shareability domain as Pe, are complete for the set of observers in the required shareability domain
- all cache, branch predictor, and TLB maintenance operations issued by Pe before the DSB are complete for the required shareability domain.

In addition, no instruction that appears in program order after the DSB instruction can execute until the DSB completes.

For details of the DSB instruction in the Thumb and ARM instruction sets see *DSB* on page A8-92.

Note

Historically, this operation was referred to as Drain Write Buffer or Data Write Barrier (DWB). From ARMv6, these names and the use of DWB were deprecated in favor of the new Data Synchronization Barrier name and DSB abbreviation. DSB better reflects the functionality provided from ARMv6, because DSB is architecturally defined to include all cache, TLB and branch prediction maintenance operations as well as explicit memory operations.

Instruction Synchronization Barrier (ISB)

An ISB instruction flushes the pipeline in the processor, so that all instructions that come after the ISB instruction in program order are fetched from cache or memory only after the ISB instruction has completed. Using an ISB ensures that the effects of context altering operations executed before the ISB are visible to the instructions fetched after the ISB instruction. Examples of context altering operations that require the insertion of an ISB instruction to ensure the operations are complete are:

- cache, TLB, and branch predictor maintenance operations
- changes to the CP14 and CP15 registers.



In addition, any branches that appear in program order after the ISB instruction are written into the branch prediction logic with the context that is visible after the ISB instruction. This is needed to ensure correct execution of the instruction stream.

Any context altering operations appearing in program order after the ISB instruction only take effect after the ISB has been executed.

For details of the ISB instruction in the Thumb and ARM instruction sets see *ISB* on page A8-102.

Pseudocode details of memory barriers

The following types define the required shareability domains and required access types used as arguments for DMB and DSB instructions:

```
enumeration MBReqDomain {MBReqDomain_FullSystem,
                        MBReqDomain_OuterShareable,
                        MBReqDomain_InnerShareable,
                        MBReqDomain_Nonshareable};

enumeration MBReqTypes {MBReqTypes_All, MBReqTypes_Writes};
```

The following procedures perform the memory barriers:

```
DataMemoryBarrier(MBReqDomain domain, MBReqTypes types)
DataSynchronizationBarrier(MBReqDomain domain, MBReqTypes types)
InstructionSynchronizationBarrier()
```

A3.9 Caches and memory hierarchy

The implementation of a memory system depends heavily on the microarchitecture and therefore the details of the system are IMPLEMENTATION DEFINED. ARMv7 defines the application level interface to the memory system, and supports a hierarchical memory system with multiple levels of cache. This section provides an application level view of this system. It contains the subsections:

- *Introduction to caches*
- *Memory hierarchy* on page A3-52
- *Implication of caches for the application programmer* on page A3-52
- *Preloading caches* on page A3-54.

A3.9.1 Introduction to caches

A cache is a block of high-speed memory that contains a number of entries, each consisting of:

- main memory address information, commonly known as a *tag*
- the associated data.

Caches are used to increase the average speed of a memory access. Cache operation takes account of two principles of locality:

Spatial locality

An access to one location is likely to be followed by accesses to adjacent locations.

Examples of this principle are:

- sequential instruction execution
- accessing a data structure.

Temporal locality

An access to an area of memory is likely to be repeated in a short time period. An example of this principle is the execution of a code loop

To minimize the quantity of control information stored, the spatial locality property is used to group several locations together under the same tag. This logical block is commonly known as a cache line. When data is loaded into a cache, access times for subsequent loads and stores are reduced, resulting in overall performance benefits. An access to information already in a cache is known as a cache hit, and other accesses are called cache misses.

Normally, caches are self-managing, with the updates occurring automatically. Whenever the processor wants to access a cacheable location, the cache is checked. If the access is a cache hit, the access occurs in the cache, otherwise a location is allocated and the cache line loaded from memory. Different cache topologies and access policies are possible, however, they must comply with the memory coherency model of the underlying architecture.

Caches introduce a number of potential problems, mainly because of:

- Memory accesses occurring at times other than when the programmer would normally expect them
- There being multiple physical locations where a data item can be held

A3.9.2 Memory hierarchy

Memory close to a processor has very low latency, but is limited in size and expensive to implement. Further from the processor it is easier to implement larger blocks of memory but these have increased latency. To optimize overall performance, an ARMv7 memory system can include multiple levels of cache in a hierarchical memory system. Figure A3-5 shows such a system, in an ARMv7-A implementation of a VMSA, supporting virtual addressing.

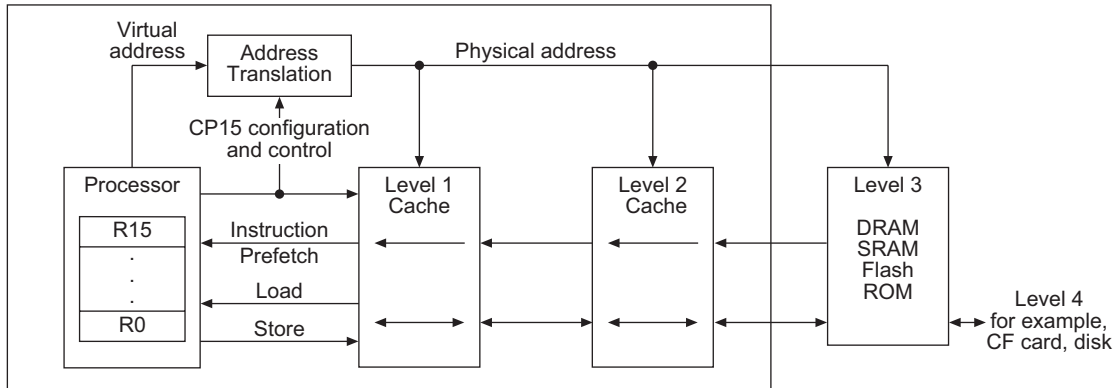

Figure A3-5 Multiple levels of cache in a memory hierarchy

Note

In this manual, in a hierarchical memory system, Level 1 refers to the level closest to the processor, as shown in Figure A3-5.

A3.9.3 Implication of caches for the application programmer

In normal operation, the caches are largely invisible to the application programmer. However they can become visible when there is a breakdown in the coherency of the caches. Such a breakdown can occur:

- when memory locations are updated by other agents in the system
- when memory updates made from the application code must be made visible to other agents in the system.

For example:

- In a system with a DMA controller that reads memory locations that are held in the data cache of a processor, a breakdown of coherency occurs when the processor has written new data in the data cache, but the DMA controller reads the old data held in memory.
- In a Harvard architecture of caches, where there are separate instruction and data caches, a breakdown of coherency occurs when new instruction data has been written into the data cache, but the instruction cache still contains the old instruction data.

Data coherency issues

You can ensure the data coherency of caches in the following ways:

- By not using the caches in situations where coherency issues can arise. You can achieve this by:
 - using Non-cacheable or, in some cases, Write-Through Cacheable memory for the caches
 - not enabling caches in the system.
- By using cache maintenance operations to manage the coherency issues in software, see *Cache maintenance functionality* on page B2-9. Many of these operations are only available to system software.
- By using hardware coherency mechanisms to ensure the coherency of data accesses to memory for cacheable locations by observers within the different shareability domains, see *Non-shareable Normal memory* on page A3-30 and *Shareable, Inner Shareable, and Outer Shareable Normal memory* on page A3-30.

The performance of these hardware coherency mechanisms is highly implementation specific. In some implementations the mechanism suppresses the ability to cache shareable locations. In other implementations, cache coherency hardware can hold data in caches while managing coherency between observers within the shareability domains.

Instruction coherency issues

How far ahead of the current point of execution instructions are prefetched from is IMPLEMENTATION DEFINED. Such prefetching can be either a fixed or a dynamically varying number of instructions, and can follow any or all possible future execution paths. For all types of memory:

- the processor might have fetched the instructions from memory at any time since the last ISB, exception entry or exception return executed by that processor
- any instructions fetched in this way might be executed multiple times, if this is required by the execution of the program, without being refetched from memory

In addition, the ARM architecture does not require the hardware to ensure coherency between instruction caches and memory, even for regions of memory with Shareable attributes. This means that for cacheable regions of memory, an instruction cache can hold instructions that were fetched from memory before the last ISB, exception entry or exception return.

If software requires coherency between instruction execution and memory, it must manage this coherency using the ISB and DSB memory barriers and cache maintenance operations, see *Ordering of cache and branch predictor maintenance operations* on page B2-21. Many of these operations are only available to system software.

A3.9.4 Preloading caches

The ARM architecture provides memory system hints PLD (Preload Data) and PLI (Preload Instruction) to permit software to communicate the expected use of memory locations to the hardware. The memory system can respond by taking actions that are expected to speed up the memory accesses if and when they do occur. The effect of these memory system hints is IMPLEMENTATION DEFINED. Typically, implementations will use this information to bring the data or instruction locations into caches that have faster access times than normal memory.

The Preload instructions are hints, and so implementations can treat them as NOPs without affecting the functional behavior of the device. The instructions do not generate synchronous Data Abort exceptions, but the memory system operations might, under exceptional circumstances, generate asynchronous aborts. For more information, see *Data Abort exception* on page B1-55.

Hardware implementations can provide other implementation-specific mechanisms to prefetch memory locations in the cache. These must comply with the general cache behavior described in *Cache behavior* on page B2-5.

Chapter A4

The Instruction Sets

This chapter describes the ARM and Thumb instruction sets. It contains the following sections:

- *About the instruction sets* on page A4-2
- *Unified Assembler Language* on page A4-4
- *Branch instructions* on page A4-7
- *Data-processing instructions* on page A4-8
- *Status register access instructions* on page A4-18
- *Load/store instructions* on page A4-19
- *Load/store multiple instructions* on page A4-22
- *Miscellaneous instructions* on page A4-23
- *Exception-generating and exception-handling instructions* on page A4-24
- *Coprocessor instructions* on page A4-25
- *Advanced SIMD and VFP load/store instructions* on page A4-26
- *Advanced SIMD and VFP register transfer instructions* on page A4-29
- *Advanced SIMD data-processing operations* on page A4-30
- *VFP data-processing instructions* on page A4-38.

A4.1 About the instruction sets

ARMv7 contains two main instruction sets, the ARM and Thumb instruction sets. Much of the functionality available is identical in the two instruction sets. This chapter describes the functionality available in the instruction sets, and the *Unified Assembler Language* (UAL) that can be assembled to either instruction set.

The two instruction sets differ in how instructions are encoded:

- Thumb instructions are either 16-bit or 32-bit, and are aligned on a two-byte boundary. 16-bit and 32-bit instructions can be intermixed freely. Many common operations are most efficiently executed using 16-bit instructions. However:
 - Most 16-bit instructions can only access eight of the general-purpose registers, R0-R7. These are known as the low registers. A small number of 16-bit instructions can access the high registers, R8-R15.
 - Many operations that would require two or more 16-bit instructions can be more efficiently executed with a single 32-bit instruction.
- ARM instructions are always 32-bit, and are aligned on a four-byte boundary.

The ARM and Thumb instruction sets can *interwork* freely, that is, different procedures can be compiled or assembled to different instruction sets, and still be able to call each other efficiently.

ThumbEE is a variant of the Thumb instruction set that is designed as a target for dynamically generated code. However, it cannot interwork freely with the ARM and Thumb instruction sets.

See:

- Chapter A5 *ARM Instruction Set Encoding* for encoding details of the ARM instruction set
- Chapter A6 *Thumb Instruction Set Encoding* for encoding details of the Thumb instruction set
- Chapter A8 *Instruction Details* for detailed descriptions of the instructions
- Chapter A9 *ThumbEE* for encoding details of the ThumbEE instruction set.

A4.1.1 Changing between Thumb state and ARM state

A processor in Thumb state (that is, executing Thumb instructions) can enter ARM state (and change to executing ARM instructions) by executing any of the following instructions: BX, BLX, or an LDR or LDM that loads the PC.

A processor in ARM state (that is, executing ARM instructions) can enter Thumb state (and change to executing Thumb instructions) by executing any of the same instructions.

In ARMv7, a processor in ARM state can also enter Thumb state (and change to executing Thumb instructions) by executing an ADC, ADD, AND, ASR, BIC, EOR, LSL, LSR, MOV, MVN, ORR, ROR, RRX, RSB, RSC, SBC, or SUB instruction that has the PC as destination register and does not set the condition flags.

Note

This permits calls and returns between ARM code written for ARMv4 processors and Thumb code running on ARMv7 processors to function correctly. In new code, ARM recommends that you use BX or BLX instructions instead. In particular, use BX LR to return from a procedure, not MOV PC, LR.

The target instruction set is either encoded directly in the instruction (for the immediate offset version of BLX), or is held as bit [0] of an *interworking address*. For details, see the description of the BXWritePC() function in *Pseudocode details of operations on ARM core registers* on page A2-12.

Exception entries and returns can also change between ARM and Thumb states. For details see *Exceptions* on page B1-30.

A4.1.2 Conditional execution

Most ARM instructions can be *conditionally executed*. This means that they only have their normal effect on the programmers' model operation, memory and coprocessors if the N, Z, C and V flags in the APSR satisfy a condition specified in the instruction. If the flags do not satisfy this condition, the instruction acts as a NOP, that is, execution advances to the next instruction as normal, including any relevant checks for exceptions being taken, but has no other effect.

Most Thumb instructions are unconditional. Conditional execution in Thumb code can be achieved using any of the following instructions:

- A 16-bit conditional branch instruction, with a branch range of -256 to $+254$ bytes. For details see *B* on page A8-44. Before ARMv6T2, this was the only mechanism for conditional execution in Thumb code.
- A 32-bit conditional branch instruction, with a branch range of approximately ± 1 MB. For details see *B* on page A8-44.
- 16-bit Compare and Branch on Zero and Compare and Branch on Nonzero instructions, with a branch range of $+4$ to $+130$ bytes. For details see *CBNZ*, *CBZ* on page A8-66.
- A 16-bit If-Then instruction that makes up to four following instructions conditional. For details see *IT* on page A8-104. The instructions that are made conditional by an IT instruction are called its *IT block*. Instructions in an IT block must either all have the same condition, or some can have one condition, and others can have the inverse condition.

For more information about conditional execution see *Conditional execution* on page A8-8.

A4.2 Unified Assembler Language

This document uses the ARM *Unified Assembler Language* (UAL). This assembly language syntax provides a canonical form for all ARM and Thumb instructions.

UAL describes the syntax for the mnemonic and the operands of each instruction. In addition, it assumes that instructions and data items can be given labels. It does not specify the syntax to be used for labels, nor what assembler directives and options are available. See your assembler documentation for these details.

Most earlier ARM assembly language mnemonics are still supported as synonyms, as described in the instruction details.

———— Note —————

Most earlier Thumb assembly language mnemonics are *not* supported. For details see Appendix C *Legacy Instruction Mnemonics*.

UAL includes *instruction selection* rules that specify which instruction encoding is selected when more than one can provide the required functionality. For example, both 16-bit and 32-bit encodings exist for an ADD R0,R1,R2 instruction. The most common instruction selection rule is that when both a 16-bit encoding and a 32-bit encoding are available, the 16-bit encoding is selected, to optimize code density.

Syntax options exist to override the normal instruction selection rules and ensure that a particular encoding is selected. These are useful when disassembling code, to ensure that subsequent assembly produces the original code, and in some other situations.

A4.2.1 Conditional instructions

For maximum portability of UAL assembly language between the ARM and Thumb instruction sets, ARM recommends that:

- IT instructions are written before conditional instructions in the correct way for the Thumb instruction set.
- When assembling to the ARM instruction set, assemblers check that any IT instructions are correct, but do not generate any code for them.

Although other Thumb instructions are unconditional, all instructions that are made conditional by an IT instruction must be written with a condition. These conditions must match the conditions imposed by the IT instruction. For example, an ITTEE EQ instruction imposes the EQ condition on the first two following instructions, and the NE condition on the next two. Those four instructions must be written with EQ, EQ, NE and NE conditions respectively.

Some instructions cannot be made conditional by an IT instruction. Some instructions can be conditional if they are the last instruction in the IT block, but not otherwise.

The branch instruction encodings that include a condition field cannot be made conditional by an IT instruction. If the assembler syntax indicates a conditional branch that correctly matches a preceding IT instruction, it is assembled using a branch instruction encoding that does not include a condition field.

A4.2.2 Use of labels in UAL instruction syntax

The UAL syntax for some instructions includes the label of an instruction or a literal data item that is at a fixed offset from the instruction being specified. The assembler must:

1. Calculate the PC or `Align(PC, 4)` value of the instruction. The PC value of an instruction is its address plus 4 for a Thumb instruction, or plus 8 for an ARM instruction. The `Align(PC, 4)` value of an instruction is its PC value ANDed with `0xFFFFF0` to force it to be word-aligned. There is no difference between the PC and `Align(PC, 4)` values for an ARM instruction, but there can be for a Thumb instruction.
2. Calculate the offset from the PC or `Align(PC, 4)` value of the instruction to the address of the labelled instruction or literal data item.
3. Assemble a *PC-relative* encoding of the instruction, that is, one that reads its PC or `Align(PC, 4)` value and adds the calculated offset to form the required address.

————— **Note** —————

For instructions that can encode a subtraction operation, if the instruction cannot encode the calculated offset but can encode minus the calculated offset, the instruction encoding specifies a subtraction of minus the calculated offset.

—————

The syntax of the following instructions includes a label:

- B, BL, and BLX (immediate). The assembler syntax for these instructions always specifies the label of the instruction that they branch to. Their encodings specify a sign-extended immediate offset that is added to the PC value of the instruction to form the target address of the branch.
- CBNZ and CBZ. The assembler syntax for these instructions always specifies the label of the instruction that they branch to. Their encodings specify a zero-extended immediate offset that is added to the PC value of the instruction to form the target address of the branch. They do not support backward branches.
- LDC, LDC2, LDR, LDRB, LDRD, LDRH, LDRSB, LDRSH, PLD, PLDW, PLI, and VLDR. The normal assembler syntax of these load instructions can specify the label of a literal data item that is to be loaded. The encodings of these instructions specify a zero-extended immediate offset that is either added to or subtracted from the `Align(PC, 4)` value of the instruction to form the address of the data item. A few such encodings perform a fixed addition or a fixed subtraction and must only be used when that operation is required, but most contain a bit that specifies whether the offset is to be added or subtracted.

When the assembler calculates an offset of 0 for the normal syntax of these instructions, it must assemble an encoding that adds 0 to the `Align(PC, 4)` value of the instruction. Encodings that subtract 0 from the `Align(PC, 4)` value cannot be specified by the normal syntax.

There is an alternative syntax for these instructions that specifies the addition or subtraction and the immediate offset explicitly. In this syntax, the label is replaced by `[PC, #+/-<imm>]`, where:

+/- Is + or omitted to specify that the immediate offset is to be added to the `Align(PC, 4)` value, or - if it is to be subtracted.

<imm> Is the immediate offset.

This alternative syntax makes it possible to assemble the encodings that subtract 0 from the `Align(PC,4)` value, and to disassemble them to a syntax that can be re-assembled correctly.

- ADR. The normal assembler syntax for this instruction can specify the label of an instruction or literal data item whose address is to be calculated. Its encoding specifies a zero-extended immediate offset that is either added to or subtracted from the `Align(PC,4)` value of the instruction to form the address of the data item, and some opcode bits that determine whether it is an addition or subtraction.

When the assembler calculates an offset of 0 for the normal syntax of this instruction, it must assemble the encoding that adds 0 to the `Align(PC,4)` value of the instruction. The encoding that subtracts 0 from the `Align(PC,4)` value cannot be specified by the normal syntax.

There is an alternative syntax for this instruction that specifies the addition or subtraction and the immediate value explicitly, by writing them as additions `ADD <Rd>,PC,#<imm>` or subtractions `SUB <Rd>,PC,#<imm>`. This alternative syntax makes it possible to assemble the encoding that subtracts 0 from the `Align(PC,4)` value, and to disassemble it to a syntax that can be re-assembled correctly.

Note

ARM recommends that where possible, you avoid using:

- the alternative syntax for the ADR, LDC, LDC2, LDR, LDRB, LDRD, LDRH, LDRSB, LDRSH, PLD, PLI, PLDW, and VLDR instructions
 - the encodings of these instructions that subtract 0 from the `Align(PC,4)` value.
-

A4.3 Branch instructions

Table A4-1 summarizes the branch instructions in the ARM and Thumb instruction sets. In addition to providing for changes in the flow of execution, some branch instructions can change instruction set.

Table A4-1 Branch instructions

Instruction	See	Range (Thumb)	Range (ARM)
Branch to target address	<i>B</i> on page A8-44	+/-16MB	+/-32MB
Compare and Branch on Nonzero, Compare and Branch on Zero	<i>CBNZ</i> , <i>CBZ</i> on page A8-66	0-126B	^a
Call a subroutine	<i>BL</i> , <i>BLX (immediate)</i> on page A8-58	+/-16MB	+/-32MB
Call a subroutine, change instruction set ^b		+/-16MB	+/-32MB
Call a subroutine, optionally change instruction set	<i>BLX (register)</i> on page A8-60	Any	Any
Branch to target address, change instruction set	<i>BX</i> on page A8-62	Any	Any
Change to Jazelle state	<i>BXJ</i> on page A8-64	-	-
Table Branch (byte offsets)	<i>TBB</i> , <i>TBH</i> on page A8-446	0-510B	^a
Table Branch (halfword offsets)		0-131070B	

- a. These instructions do not exist in the ARM instruction set.
- b. The range is determined by the instruction set of the BLX instruction, not of the instruction it branches to.

Branches to loaded and calculated addresses can be performed by LDR, LDM and data-processing instructions. For details see *Load/store instructions* on page A4-19, *Load/store multiple instructions* on page A4-22, *Standard data-processing instructions* on page A4-8, and *Shift instructions* on page A4-10.

A4.4 Data-processing instructions

Core data-processing instructions belong to one of the following groups:

- *Standard data-processing instructions*. These instructions perform basic data-processing operations, and share a common format with some variations.
- *Shift instructions* on page A4-10.
- *Saturating instructions* on page A4-13.
- *Packing and unpacking instructions* on page A4-14.
- *Miscellaneous data-processing instructions* on page A4-15.
- *Parallel addition and subtraction instructions* on page A4-16.
- *Divide instructions* on page A4-17.

For extension data-processing instructions, see *Advanced SIMD data-processing operations* on page A4-30 and *VFP data-processing instructions* on page A4-38.

A4.4.1 Standard data-processing instructions

These instructions generally have a destination register *Rd*, a first operand register *Rn*, and a second operand. The second operand can be another register *Rm*, or an immediate constant.

If the second operand is an immediate constant, it can be:

- Encoded directly in the instruction.
- A *modified immediate constant* that uses 12 bits of the instruction to encode a range of constants. Thumb and ARM instructions have slightly different ranges of modified immediate constants. For details see *Modified immediate constants in Thumb instructions* on page A6-17 and *Modified immediate constants in ARM instructions* on page A5-9.

If the second operand is another register, it can optionally be shifted in any of the following ways:

LSL	Logical Shift Left by 1-31 bits.
LSR	Logical Shift Right by 1-32 bits.
ASR	Arithmetic Shift Right by 1-32 bits.
ROR	Rotate Right by 1-31 bits.
RRX	Rotate Right with Extend. For details see <i>Shift and rotate operations</i> on page A2-5.

In Thumb code, the amount to shift by is always a constant encoded in the instruction. In ARM code, the amount to shift by is either a constant encoded in the instruction, or the value of a register *Rs*.

For instructions other than CMN, CMP, TEQ, and TST, the result of the data-processing operation is placed in the destination register. In the ARM instruction set, the destination register can be the PC, causing the result to be treated as an address to branch to. In the Thumb instruction set, this is only permitted for some 16-bit forms of the ADD and MOV instructions.

These instructions can optionally set the condition code flags, according to the result of the operation. If they do not set the flags, existing flag settings from a previous instruction are preserved.

Table A4-2 summarizes the main data-processing instructions in the Thumb and ARM instruction sets. Generally, each of these instructions is described in three sections in Chapter A8 *Instruction Details*, one section for each of the following:

- INSTRUCTION (immediate) where the second operand is a modified immediate constant.
- INSTRUCTION (register) where the second operand is a register, or a register shifted by a constant.
- INSTRUCTION (register-shifted register) where the second operand is a register shifted by a value obtained from another register. These are only available in the ARM instruction set.

Table A4-2 Standard data-processing instructions

Instruction	Mnemonic	Notes
Add with Carry	ADC	-
Add	ADD	Thumb instruction set permits use of a modified immediate constant or a zero-extended 12-bit immediate constant.
Form PC-relative Address	ADR	First operand is the PC. Second operand is an immediate constant. Thumb instruction set uses a zero-extended 12-bit immediate constant. Operation is an addition or a subtraction.
Bitwise AND	AND	-
Bitwise Bit Clear	BIC	-
Compare Negative	CMN	Sets flags. Like ADD but with no destination register.
Compare	CMP	Sets flags. Like SUB but with no destination register.
Bitwise Exclusive OR	EOR	-
Copy operand to destination	MOV	Has only one operand, with the same options as the second operand in most of these instructions. If the operand is a shifted register, the instruction is an LSL, LSR, ASR, or ROR instruction instead. For details see <i>Shift instructions</i> on page A4-10. The ARM and Thumb instruction sets permit use of a modified immediate constant or a zero-extended 16-bit immediate constant.
Bitwise NOT	MVN	Has only one operand, with the same options as the second operand in most of these instructions.
Bitwise OR NOT	ORN	Not available in the ARM instruction set.
Bitwise OR	ORR	-

Table A4-2 Standard data-processing instructions (continued)

Instruction	Mnemonic	Notes
Reverse Subtract	RSB	Subtracts first operand from second operand. This permits subtraction from constants and shifted registers.
Reverse Subtract with Carry	RSC	Not available in the Thumb instruction set.
Subtract with Carry	SBC	-
Subtract	SUB	Thumb instruction set permits use of a modified immediate constant or a zero-extended 12-bit immediate constant.
Test Equivalence	TEQ	Sets flags. Like EOR but with no destination register.
Test	TST	Sets flags. Like AND but with no destination register.

A4.4.2 Shift instructions

Table A4-3 lists the shift instructions in the ARM and Thumb instruction sets.

Table A4-3 Shift instructions

Instruction	See
Arithmetic Shift Right	<i>ASR (immediate)</i> on page A8-40
Arithmetic Shift Right	<i>ASR (register)</i> on page A8-42
Logical Shift Left	<i>LSL (immediate)</i> on page A8-178
Logical Shift Left	<i>LSL (register)</i> on page A8-180
Logical Shift Right	<i>LSR (immediate)</i> on page A8-182
Logical Shift Right	<i>LSR (register)</i> on page A8-184
Rotate Right	<i>ROR (immediate)</i> on page A8-278
Rotate Right	<i>ROR (register)</i> on page A8-280
Rotate Right with Extend	<i>RRX</i> on page A8-282

In the ARM instruction set only, the destination register of these instructions can be the PC, causing the result to be treated as an address to branch to.

A4.4.3 Multiply instructions

These instructions can operate on signed or unsigned quantities. In some types of operation, the results are same whether the operands are signed or unsigned.

- Table A4-4 summarizes the multiply instructions where there is no distinction between signed and unsigned quantities.
The least significant 32 bits of the result are used. More significant bits are discarded.
- Table A4-5 summarizes the signed multiply instructions.
- Table A4-6 on page A4-12 summarizes the unsigned multiply instructions.

Table A4-4 General multiply instructions

Instruction	See	Operation (number of bits)
Multiply Accumulate	<i>MLA</i> on page A8-190	$32 = 32 + 32 \times 32$
Multiply and Subtract	<i>MLS</i> on page A8-192	$32 = 32 - 32 \times 32$
Multiply	<i>MUL</i> on page A8-212	$32 = 32 \times 32$

Table A4-5 Signed multiply instructions

Instruction	See	Operation (number of bits)
Signed Multiply Accumulate (halfwords)	<i>SMLABB, SMLABT, SMLATB, SMLATT</i> on page A8-330	$32 = 32 + 16 \times 16$
Signed Multiply Accumulate Dual	<i>SMLAD</i> on page A8-332	$32 = 32 + 16 \times 16 + 16 \times 16$
Signed Multiply Accumulate Long	<i>SMLAL</i> on page A8-334	$64 = 64 + 32 \times 32$
Signed Multiply Accumulate Long (halfwords)	<i>SMLALBB, SMLALBT, SMLALTB, SMLALTT</i> on page A8-336	$64 = 64 + 16 \times 16$
Signed Multiply Accumulate Long Dual	<i>SMLALD</i> on page A8-338	$64 = 64 + 16 \times 16 + 16 \times 16$
Signed Multiply Accumulate (word by halfword)	<i>SMLAWB, SMLAWT</i> on page A8-340	$32 = 32 + 32 \times 16^a$
Signed Multiply Subtract Dual	<i>SMLS</i> D on page A8-342	$32 = 32 + 16 \times 16 - 16 \times 16$
Signed Multiply Subtract Long Dual	<i>SMLS</i> LD on page A8-344	$64 = 64 + 16 \times 16 - 16 \times 16$
Signed Most Significant Word Multiply Accumulate	<i>SMMLA</i> on page A8-346	$32 = 32 + 32 \times 32^b$

Table A4-5 Signed multiply instructions (continued)

Instruction	See	Operation (number of bits)
Signed Most Significant Word Multiply Subtract	<i>SMMLS</i> on page A8-348	$32 = 32 - 32 \times 32^b$
Signed Most Significant Word Multiply	<i>SMMUL</i> on page A8-350	$32 = 32 \times 32^b$
Signed Dual Multiply Add	<i>SMUAD</i> on page A8-352	$32 = 16 \times 16 + 16 \times 16$
Signed Multiply (halfwords)	<i>SMULBB</i> , <i>SMULBT</i> , <i>SMULTB</i> , <i>SMULTT</i> on page A8-354	$32 = 16 \times 16$
Signed Multiply Long	<i>SMULL</i> on page A8-356	$64 = 32 \times 32$
Signed Multiply (word by halfword)	<i>SMULWB</i> , <i>SMULWT</i> on page A8-358	$32 = 32 \times 16^a$
Signed Dual Multiply Subtract	<i>SMUSD</i> on page A8-360	$32 = 16 \times 16 - 16 \times 16$

a. The most significant 32 bits of the 48-bit product are used. Less significant bits are discarded.

b. The most significant 32 bits of the 64-bit product are used. Less significant bits are discarded.

Table A4-6 Unsigned multiply instructions

Instruction	See	Operation (number of bits)
Unsigned Multiply Accumulate Accumulate Long	<i>UMAAL</i> on page A8-482	$64 = 32 + 32 + 32 \times 32$
Unsigned Multiply Accumulate Long	<i>UMLAL</i> on page A8-484	$64 = 64 + 32 \times 32$
Unsigned Multiply Long	<i>UMULL</i> on page A8-486	$64 = 32 \times 32$

A4.4.4 Saturating instructions

Table A4-7 lists the saturating instructions in the ARM and Thumb instruction sets. For more information, see *Pseudocode details of saturation* on page A2-9.

Table A4-7 Saturating instructions

Instruction	See	Operation
Signed Saturate	<i>SSAT</i> on page A8-362	Saturates optionally shifted 32-bit value to selected range
Signed Saturate 16	<i>SSAT16</i> on page A8-364	Saturates two 16-bit values to selected range
Unsigned Saturate	<i>USAT</i> on page A8-504	Saturates optionally shifted 32-bit value to selected range
Unsigned Saturate 16	<i>USAT16</i> on page A8-506	Saturates two 16-bit values to selected range

A4.4.5 Packing and unpacking instructions

Table A4-8 lists the packing and unpacking instructions in the ARM and Thumb instruction sets. These are all available from ARMv6T2 in the Thumb instruction set, and from ARMv6 onwards in the ARM instruction set.

Table A4-8 Packing and unpacking instructions

Instruction	See	Operation
Pack Halfword	<i>PKH</i> on page A8-234	Combine halfwords
Signed Extend and Add Byte	<i>SXTAB</i> on page A8-434	Extend 8 bits to 32 and add
Signed Extend and Add Byte 16	<i>SXTAB16</i> on page A8-436	Dual extend 8 bits to 16 and add
Signed Extend and Add Halfword	<i>SXTAH</i> on page A8-438	Extend 16 bits to 32 and add
Signed Extend Byte	<i>SXTB</i> on page A8-440	Extend 8 bits to 32
Signed Extend Byte 16	<i>SXTB16</i> on page A8-442	Dual extend 8 bits to 16
Signed Extend Halfword	<i>SXTH</i> on page A8-444	Extend 16 bits to 32
Unsigned Extend and Add Byte	<i>UXTAB</i> on page A8-514	Extend 8 bits to 32 and add
Unsigned Extend and Add Byte 16	<i>UXTAB16</i> on page A8-516	Dual extend 8 bits to 16 and add
Unsigned Extend and Add Halfword	<i>UXTAH</i> on page A8-518	Extend 16 bits to 32 and add
Unsigned Extend Byte	<i>UXTB</i> on page A8-520	Extend 8 bits to 32
Unsigned Extend Byte 16	<i>UXTB16</i> on page A8-522	Dual extend 8 bits to 16
Unsigned Extend Halfword	<i>UXTH</i> on page A8-524	Extend 16 bits to 32

A4.4.6 Miscellaneous data-processing instructions

Table A4-9 lists the miscellaneous data-processing instructions in the ARM and Thumb instruction sets. Immediate values in these instructions are simple binary numbers.

Table A4-9 Miscellaneous data-processing instructions

Instruction	See	Notes
Bit Field Clear	<i>BFC</i> on page A8-46	-
Bit Field Insert	<i>BFI</i> on page A8-48	-
Count Leading Zeros	<i>CLZ</i> on page A8-72	-
Move Top	<i>MOVT</i> on page A8-200	Moves 16-bit immediate value to top halfword. Bottom halfword unchanged.
Reverse Bits	<i>RBIT</i> on page A8-270	-
Byte-Reverse Word	<i>REV</i> on page A8-272	-
Byte-Reverse Packed Halfword	<i>REV16</i> on page A8-274	-
Byte-Reverse Signed Halfword	<i>REVSH</i> on page A8-276	-
Signed Bit Field Extract	<i>SBFX</i> on page A8-308	-
Select Bytes using GE flags	<i>SEL</i> on page A8-312	-
Unsigned Bit Field Extract	<i>UBFX</i> on page A8-466	-
Unsigned Sum of Absolute Differences	<i>USAD8</i> on page A8-500	-
Unsigned Sum of Absolute Differences and Accumulate	<i>USADA8</i> on page A8-502	-

A4.4.7 Parallel addition and subtraction instructions

These instructions perform additions and subtractions on the values of two registers and write the result to a destination register, treating the register values as sets of two halfwords or four bytes. They are available in ARMv6 and above.

These instructions consist of a prefix followed by a main instruction mnemonic. The prefixes are as follows:

S	Signed arithmetic modulo 2^8 or 2^{16} .
Q	Signed saturating arithmetic.
SH	Signed arithmetic, halving the results.
U	Unsigned arithmetic modulo 2^8 or 2^{16} .
UQ	Unsigned saturating arithmetic.
UH	Unsigned arithmetic, halving the results.

The main instruction mnemonics are as follows:

ADD16	Adds the top halfwords of two operands to form the top halfword of the result, and the bottom halfwords of the same two operands to form the bottom halfword of the result.
ASX	Exchanges halfwords of the second operand, and then adds top halfwords and subtracts bottom halfwords.
SAX	Exchanges halfwords of the second operand, and then subtracts top halfwords and adds bottom halfwords.
SUB16	Subtracts each halfword of the second operand from the corresponding halfword of the first operand to form the corresponding halfword of the result.
ADD8	Adds each byte of the second operand to the corresponding byte of the first operand to form the corresponding byte of the result.
SUB8	Subtracts each byte of the second operand from the corresponding byte of the first operand to form the corresponding byte of the result.

The instruction set permits all 36 combinations of prefix and main instruction operand.

See also *Advanced SIMD parallel addition and subtraction* on page A4-31.

A4.4.8 Divide instructions

In the ARMv7-R profile, the Thumb instruction set includes signed and unsigned integer divide instructions that are implemented in hardware. For details of the instructions see:

- *SDIV* on page A8-310
- *UDIV* on page A8-468.

———— **Note** —————

- *SDIV* and *UDIV* are UNDEFINED in the ARMv7-A profile.
- The ARMv7-M profile also includes the *SDIV* and *UDIV* instructions.

In the ARMv7-R profile, the SCTL.R.DZ bit enables divide by zero fault detection, see *c1, System Control Register (SCTLR)* on page B4-45:

DZ == 0 Divide-by-zero returns a zero result.

DZ == 1 *SDIV* and *UDIV* generate an Undefined Instruction exception on a divide-by-zero.

The SCTL.R.DZ bit is cleared to zero on reset.

A4.5 Status register access instructions

The MRS and MSR instructions move the contents of the *Application Program Status Register* (APSR) to or from a general-purpose register.

The APSR is described in *The Application Program Status Register (APSR)* on page A2-14.

The condition flags in the APSR are normally set by executing data-processing instructions, and are normally used to control the execution of conditional instructions. However, you can set the flags explicitly using the MSR instruction, and you can read the current state of the flags explicitly using the MRS instruction.

For details of the system level use of status register access instructions CPS, MRS, and MSR, see Chapter B6 *System Instructions*.

A4.6 Load/store instructions

Table A4-10 summarizes the general-purpose register load/store instructions in the ARM and Thumb instruction sets. See also:

- *Load/store multiple instructions* on page A4-22
- *Advanced SIMD and VFP load/store instructions* on page A4-26.

Load/store instructions have several options for addressing memory. For more information, see *Addressing modes* on page A4-20.

Table A4-10 Load/store instructions

Data type	Load	Store	Load unprivileged	Store unprivileged	Load-Exclusive	Store-Exclusive
32-bit word	LDR	STR	LDRT	STRT	LDREX	STREX
16-bit halfword	-	STRH	-	STRHT	-	STREXH
16-bit unsigned halfword	LDRH	-	LDRHT	-	LDREXH	-
16-bit signed halfword	LDRSH	-	LDRSHT	-	-	-
8-bit byte	-	STRB	-	STRBT	-	STREXB
8-bit unsigned byte	LDRB	-	LDRBT	-	LDREXB	-
8-bit signed byte	LDRSB	-	LDRSBT	-	-	-
Two 32-bit words	LDRD	STRD	-	-	-	-
64-bit doubleword	-	-	-	-	LDREXD	STREXD

A4.6.1 Loads to the PC

The LDR instruction can be used to load a value into the PC. The value loaded is treated as an interworking address, as described by the LoadWritePC() pseudocode function in *Pseudocode details of operations on ARM core registers* on page A2-12.

A4.6.2 Halfword and byte loads and stores

Halfword and byte stores store the least significant halfword or byte from the register, to 16 or 8 bits of memory respectively. There is no distinction between signed and unsigned stores.

Halfword and byte loads load 16 or 8 bits from memory into the least significant halfword or byte of a register. Unsigned loads zero-extend the loaded value to 32 bits, and signed loads sign-extend the value to 32 bits.

A4.6.3 Unprivileged loads and stores

In an unprivileged mode, unprivileged loads and stores operate in exactly the same way as the corresponding ordinary operations. In a privileged mode, unprivileged loads and stores are treated as though they were executed in an unprivileged mode. For more information, see *Privilege level access controls for data accesses* on page A3-38.

A4.6.4 Exclusive loads and stores

Exclusive loads and stores provide for shared memory synchronization. For more information, see *Synchronization and semaphores* on page A3-12.

A4.6.5 Addressing modes

The address for a load or store is formed from two parts: a value from a base register, and an offset.

The base register can be any one of the general-purpose registers.

For loads, the base register can be the PC. This permits PC-relative addressing for position-independent code. Instructions marked (literal) in their title in Chapter A8 *Instruction Details* are PC-relative loads.

The offset takes one of three formats:

- | | |
|------------------------|--|
| Immediate | The offset is an unsigned number that can be added to or subtracted from the base register value. Immediate offset addressing is useful for accessing data elements that are a fixed distance from the start of the data object, such as structure fields, stack offsets and input/output registers. |
| Register | The offset is a value from a general-purpose register. This register cannot be the PC. The value can be added to, or subtracted from, the base register value. Register offsets are useful for accessing arrays or blocks of data. |
| Scaled register | The offset is a general-purpose register, other than the PC, shifted by an immediate value, then added to or subtracted from the base register. This means an array index can be scaled by the size of each array element. |

The offset and base register can be used in three different ways to form the memory address. The addressing modes are described as follows:

- | | |
|---------------------|--|
| Offset | The offset is added to or subtracted from the base register to form the memory address. |
| Pre-indexed | The offset is added to or subtracted from the base register to form the memory address. The base register is then updated with this new address, to permit automatic indexing through an array or memory block. |
| Post-indexed | The value of the base register alone is used as the memory address. The offset is then added to or subtracted from the base register. The result is stored back in the base register, to permit automatic indexing through an array or memory block. |

———— **Note** ————

Not every variant is available for every instruction, and the range of permitted immediate values and the options for scaled registers vary from instruction to instruction. See Chapter A8 *Instruction Details* for full details for each instruction.

A4.7 Load/store multiple instructions

Load Multiple instructions load a subset, or possibly all, of the general-purpose registers from memory.

Store Multiple instructions store a subset, or possibly all, of the general-purpose registers to memory.

The memory locations are consecutive word-aligned words. The addresses used are obtained from a base register, and can be either above or below the value in the base register. The base register can optionally be updated by the total size of the data transferred.

Table A4-11 summarizes the load/store multiple instructions in the ARM and Thumb instruction sets.

Table A4-11 Load/store multiple instructions

Instruction	See
Load Multiple, Increment After or Full Descending	<i>LDM / LDMIA / LDMFD</i> on page A8-110
Load Multiple, Decrement After or Full Ascending ^a	<i>LDMDA / LDMFA</i> on page A8-112
Load Multiple, Decrement Before or Empty Ascending	<i>LDMDB / LDMEA</i> on page A8-114
Load Multiple, Increment Before or Empty Descending ^a	<i>LDMIB / LDMED</i> on page A8-116
Pop multiple registers off the stack ^b	<i>POP</i> on page A8-246
Push multiple registers onto the stack ^c	<i>PUSH</i> on page A8-248
Store Multiple, Increment After or Empty Ascending	<i>STM / STMIA / STMEA</i> on page A8-374
Store Multiple, Decrement After or Empty Descending ^a	<i>STMDA / STMED</i> on page A8-376
Store Multiple, Decrement Before or Full Descending	<i>STMDB / STMFD</i> on page A8-378
Store Multiple, Increment Before or Full Ascending ^a	<i>STMIB / STMFA</i> on page A8-380

a. Not available in the Thumb instruction set.

b. This instruction is equivalent to an LDM instruction with the SP as base register, and base register updating.

c. This instruction is equivalent to an STMDB instruction with the SP as base register, and base register updating.

System level variants of the LDM and STM instructions load and store User mode registers from a privileged mode. Another system level variant of the LDM instruction performs an exception return. For details, see Chapter B6 *System Instructions*.

A4.7.1 Loads to the PC

The LDM, LDMDA, LDMDB, LDMIB, and POP instructions can be used to load a value into the PC. The value loaded is treated as an interworking address, as described by the `LoadWritePC()` pseudocode function in *Pseudocode details of operations on ARM core registers* on page A2-12.

A4.8 Miscellaneous instructions

Table A4-12 summarizes the miscellaneous instructions in the ARM and Thumb instruction sets.

Table A4-12 Miscellaneous instructions

Instruction	See
Clear-Exclusive	<i>CLREX</i> on page A8-70
Debug hint	<i>DBG</i> on page A8-88
Data Memory Barrier	<i>DMB</i> on page A8-90
Data Synchronization Barrier	<i>DSB</i> on page A8-92
Instruction Synchronization Barrier	<i>ISB</i> on page A8-102
If Then (makes following instructions conditional)	<i>IT</i> on page A8-104
No Operation	<i>NOP</i> on page A8-222
Preload Data	<i>PLD, PLDW (immediate)</i> on page A8-236 <i>PLD (literal)</i> on page A8-238 <i>PLD, PLDW (register)</i> on page A8-240
Preload Instruction	<i>PLI (immediate, literal)</i> on page A8-242 <i>PLI (register)</i> on page A8-244
Set Endianness	<i>SETEND</i> on page A8-314
Send Event	<i>SEV</i> on page A8-316
Supervisor Call	<i>SVC (previously SWI)</i> on page A8-430
Swap, Swap Byte. Use deprecated. ^a	<i>SWP, SWPB</i> on page A8-432
Wait For Event	<i>WFE</i> on page A8-808
Wait For Interrupt	<i>WFI</i> on page A8-810
Yield	<i>YIELD</i> on page A8-812

a. Use LoadStore-Exclusive instructions instead, see *Load/store instructions* on page A4-19.

A4.9 Exception-generating and exception-handling instructions

The following instructions are intended specifically to cause a processor exception to occur:

- The Supervisor Call (SVC, previously SWI) instruction is used to cause an SVC exception to occur. This is the main mechanism for User mode code to make calls to privileged operating system code. For more information, see *Supervisor Call (SVC) exception* on page B1-52.
- The Breakpoint instruction BKPT provides for software breakpoints. For more information, see *About debug events* on page C3-2.
- In privileged system level code, the Secure Monitor Call (SMC, previously SMI) instruction. For more information, see *Secure Monitor Call (SMC) exception* on page B1-53.

System level variants of the SUBS and LDM instructions can be used to return from exceptions. From ARMv6, the SRS instruction can be used near the start of an exception handler to store return information, and the RFE instruction can be used to return from an exception using the stored return information. For details of these instructions, see Chapter B6 *System Instructions*.

A4.10 Coprocessor instructions

There are three types of instruction for communicating with coprocessors. These permit the processor to:

- Initiate a coprocessor data-processing operation. For details see *CDP*, *CDP2* on page A8-68.
- Transfer general-purpose registers to and from coprocessor registers. For details, see:
 - *MCR*, *MCR2* on page A8-186
 - *MCRR*, *MCRR2* on page A8-188
 - *MRC*, *MRC2* on page A8-202
 - *MRRC*, *MRRC2* on page A8-204.
- Load or store the values of coprocessor registers. For details, see:
 - *LDC*, *LDC2 (immediate)* on page A8-106
 - *LDC*, *LDC2 (literal)* on page A8-108
 - *STC*, *STC2* on page A8-372.

The instruction set distinguishes up to 16 coprocessors with a 4-bit field in each coprocessor instruction, so each coprocessor is assigned a particular number.

———— **Note** —————

One coprocessor can use more than one of the 16 numbers if a large coprocessor instruction set is required.

Coprocessors 10 and 11 are used, together, for VFP and some Advanced SIMD functionality. There are different instructions for accessing these coprocessors, of similar types to the instructions for the other coprocessors, that is, to:

- Initiate a coprocessor data-processing operation. For details see *VFP data-processing instructions* on page A4-38.
- Transfer general-purpose registers to and from coprocessor registers. For details, see *Advanced SIMD and VFP register transfer instructions* on page A4-29.
- Load or store the values of coprocessor registers. For details, see *Advanced SIMD and VFP load/store instructions* on page A4-26.

Coprocessors execute the same instruction stream as the processor, ignoring non-coprocessor instructions and coprocessor instructions for other coprocessors. Coprocessor instructions that cannot be executed by any coprocessor hardware cause an Undefined Instruction exception.

For more information about specific coprocessors see *Coprocessor support* on page A2-68.

A4.11 Advanced SIMD and VFP load/store instructions

Table A4-13 summarizes the extension register load/store instructions in the Advanced SIMD and VFP instruction sets.

Advanced SIMD also provides instructions for loading and storing multiple elements, or structures of elements, see *Element and structure load/store instructions* on page A4-27.

Table A4-13 Extension register load/store instructions

Instruction	See	Operation
Vector Load Multiple	<i>VLDM</i> on page A8-626	Load 1-16 consecutive 64-bit registers (Adv. SIMD and VFP) Load 1-16 consecutive 32-bit registers (VFP only)
Vector Load Register	<i>VLDR</i> on page A8-628	Load one 64-bit register (Adv. SIMD and VFP) Load one 32-bit register (VFP only)
Vector Store Multiple	<i>VSTM</i> on page A8-784	Store 1-16 consecutive 64-bit registers (Adv. SIMD and VFP) Store 1-16 consecutive 32-bit registers (VFP only)
Vector Store Register	<i>VSTR</i> on page A8-786	Store one 64-bit register (Adv. SIMD and VFP) Store one 32-bit register (VFP only)

A4.11.1 Element and structure load/store instructions

Table A4-14 shows the element and structure load/store instructions available in the Advanced SIMD instruction set. Loading and storing structures of more than one element automatically de-interleaves or interleaves the elements, see Figure A4-1 on page A4-28 for an example of de-interleaving. Interleaving is the inverse process.

Table A4-14 Element and structure load/store instructions

Instruction	See
Load single element	
Multiple elements	<i>VLD1 (multiple single elements)</i> on page A8-602
To one lane	<i>VLD1 (single element to one lane)</i> on page A8-604
To all lanes	<i>VLD1 (single element to all lanes)</i> on page A8-606
Load 2-element structure	
Multiple structures	<i>VLD2 (multiple 2-element structures)</i> on page A8-608
To one lane	<i>VLD2 (single 2-element structure to one lane)</i> on page A8-610
To all lanes	<i>VLD2 (single 2-element structure to all lanes)</i> on page A8-612
Load 3-element structure	
Multiple structures	<i>VLD3 (multiple 3-element structures)</i> on page A8-614
To one lane	<i>VLD3 (single 3-element structure to one lane)</i> on page A8-616
To all lanes	<i>VLD3 (single 3-element structure to all lanes)</i> on page A8-618
Load 4-element structure	
Multiple structures	<i>VLD4 (multiple 4-element structures)</i> on page A8-620
To one lane	<i>VLD4 (single 4-element structure to one lane)</i> on page A8-622
To all lanes	<i>VLD4 (single 4-element structure to all lanes)</i> on page A8-624
Store single element	
Multiple elements	<i>VST1 (multiple single elements)</i> on page A8-768
From one lane	<i>VST1 (single element from one lane)</i> on page A8-770

Table A4-14 Element and structure load/store instructions (continued)

Instruction	See
Store 2-element structure	
Multiple structures	<i>VST2 (multiple 2-element structures)</i> on page A8-772
From one lane	<i>VST2 (single 2-element structure from one lane)</i> on page A8-774
Store 3-element structure	
Multiple structures	<i>VST3 (multiple 3-element structures)</i> on page A8-776
From one lane	<i>VST3 (single 3-element structure from one lane)</i> on page A8-778
Store 4-element structure	
Multiple structures	<i>VST4 (multiple 4-element structures)</i> on page A8-780
From one lane	<i>VST4 (single 4-element structure from one lane)</i> on page A8-782

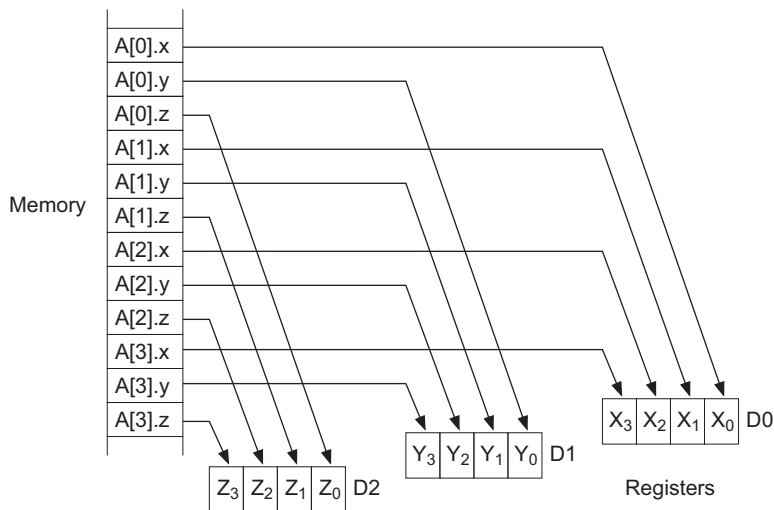

Figure A4-1 De-interleaving an array of 3-element structures

A4.12 Advanced SIMD and VFP register transfer instructions

Table A4-15 summarizes the extension register transfer instructions in the Advanced SIMD and VFP instruction sets. These instructions transfer data from ARM core registers to extension registers, or from extension registers to ARM core registers.

Advanced SIMD vectors, and single-precision and double-precision VFP registers, are all views of the same extension register set. For details see *Advanced SIMD and VFP extension registers* on page A2-21.

Table A4-15 Extension register transfer instructions

Instruction	See
Copy element from ARM core register to every element of Advanced SIMD vector	<i>VDUP (ARM core register)</i> on page A8-594
Copy byte, halfword, or word from ARM core register to extension register	<i>VMOV (ARM core register to scalar)</i> on page A8-644
Copy byte, halfword, or word from extension register to ARM core register	<i>VMOV (scalar to ARM core register)</i> on page A8-646
Copy from single-precision VFP register to ARM core register, or from ARM core register to single-precision VFP register	<i>VMOV (between ARM core register and single-precision register)</i> on page A8-648
Copy two words from ARM core registers to consecutive single-precision VFP registers, or from consecutive single-precision VFP registers to ARM core registers	<i>VMOV (between two ARM core registers and two single-precision registers)</i> on page A8-650
Copy two words from ARM core registers to doubleword extension register, or from doubleword extension register to ARM core registers	<i>VMOV (between two ARM core registers and a doubleword extension register)</i> on page A8-652
Copy from Advanced SIMD and VFP extension System Register to ARM core register	<i>VMRS</i> on page A8-658 <i>VMRS</i> on page B6-27 (system level view)
Copy from ARM core register to Advanced SIMD and VFP extension System Register	<i>VMSR</i> on page A8-660 <i>VMSR</i> on page B6-29 (system level view)

A4.13 Advanced SIMD data-processing operations

Advanced SIMD data-processing operations process registers containing vectors of elements of the same type packed together, enabling the same operation to be performed on multiple items in parallel.

Instructions operate on vectors held in 64-bit or 128-bit registers. Figure A4-2 shows an operation on two 64-bit operand vectors, generating a 64-bit vector result.

Note

Figure A4-2 and other similar figures show 64-bit vectors that consist of four 16-bit elements, and 128-bit vectors that consist of four 32-bit elements. Other element sizes produce similar figures, but with one, two, eight, or sixteen operations performed in parallel instead of four.

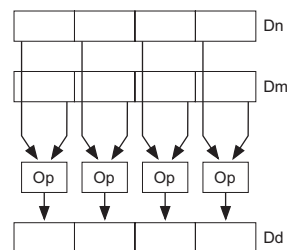

Figure A4-2 Advanced SIMD instruction operating on 64-bit registers

Many Advanced SIMD instructions have variants that produce vectors of elements double the size of the inputs. In this case, the number of elements in the result vector is the same as the number of elements in the operand vectors, but each element, and the whole vector, is double the size.

Figure A4-3 shows an example of an Advanced SIMD instruction operating on 64-bit registers, and generating a 128-bit result.

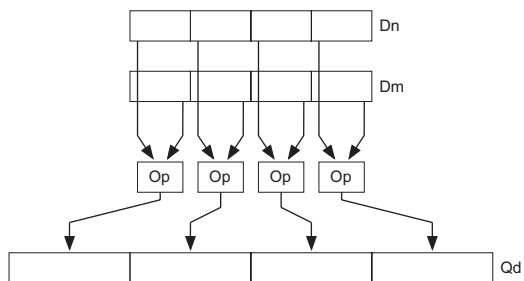

Figure A4-3 Advanced SIMD instruction producing wider result

There are also Advanced SIMD instructions that have variants that produce vectors containing elements half the size of the inputs. Figure A4-4 on page A4-31 shows an example of an Advanced SIMD instruction operating on one 128-bit register, and generating a 64-bit result.

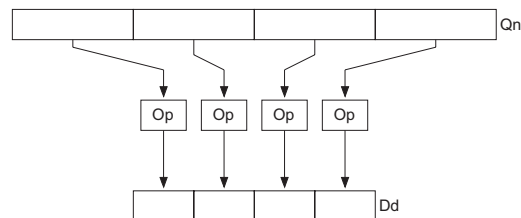

Figure A4-4 Advanced SIMD instruction producing narrower result

Some Advanced SIMD instructions do not conform to these standard patterns. Their operation patterns are described in the individual instruction descriptions.

Advanced SIMD instructions that perform floating-point arithmetic use the ARM standard floating-point arithmetic defined in *Floating-point data types and arithmetic* on page A2-32.

A4.13.1 Advanced SIMD parallel addition and subtraction

Table A4-16 shows the Advanced SIMD parallel add and subtract instructions.

Table A4-16 Advanced SIMD parallel add and subtract instructions

Instruction	See
Vector Add	<i>VADD (integer)</i> on page A8-536 <i>VADD (floating-point)</i> on page A8-538
Vector Add and Narrow, returning High Half	<i>VADDHN</i> on page A8-540
Vector Add Long, Vector Add Wide	<i>VADDL</i> , <i>VADDW</i> on page A8-542
Vector Halving Add, Vector Halving Subtract	<i>VHADD</i> , <i>VHSUB</i> on page A8-600
Vector Pairwise Add and Accumulate Long	<i>VPADAL</i> on page A8-682
Vector Pairwise Add	<i>VPADD (integer)</i> on page A8-684 <i>VPADD (floating-point)</i> on page A8-686
Vector Pairwise Add Long	<i>VPADDL</i> on page A8-688
Vector Rounding Add and Narrow, returning High Half	<i>VRADDHN</i> on page A8-726
Vector Rounding Halving Add	<i>VRHADD</i> on page A8-734
Vector Rounding Subtract and Narrow, returning High Half	<i>VRSUBHN</i> on page A8-748
Vector Saturating Add	<i>VQADD</i> on page A8-700
Vector Saturating Subtract	<i>VQSUB</i> on page A8-724

Table A4-16 Advanced SIMD parallel add and subtract instructions (continued)

Instruction	See
Vector Subtract	<i>VSUB (integer)</i> on page A8-788 <i>VSUB (floating-point)</i> on page A8-790
Vector Subtract and Narrow, returning High Half	<i>VSUBHN</i> on page A8-792
Vector Subtract Long, Vector Subtract Wide	<i>VSUBL, VSUBW</i> on page A8-794

A4.13.2 Bitwise Advanced SIMD data-processing instructions

Table A4-17 shows bitwise Advanced SIMD data-processing instructions. These operate on the doubleword (64-bit) or quadword (128-bit) extension registers, and there is no division into vector elements.

Table A4-17 Bitwise Advanced SIMD data-processing instructions

Instruction	See
Vector Bitwise AND	<i>VAND (register)</i> on page A8-544
Vector Bitwise Bit Clear (AND complement)	<i>VBIC (immediate)</i> on page A8-546 <i>VBIC (register)</i> on page A8-548
Vector Bitwise Exclusive OR	<i>VEOR</i> on page A8-596
Vector Bitwise Insert if False	<i>VBIF, VBIT, VBSL</i> on page A8-550
Vector Bitwise Insert if True	
Vector Bitwise Move	<i>VMOV (immediate)</i> on page A8-640 <i>VMOV (register)</i> on page A8-642
Vector Bitwise NOT	<i>VMVN (immediate)</i> on page A8-668 <i>VMVN (register)</i> on page A8-670
Vector Bitwise OR	<i>VORR (immediate)</i> on page A8-678 <i>VORR (register)</i> on page A8-680
Vector Bitwise OR NOT	<i>VORN (register)</i> on page A8-676
Vector Bitwise Select	<i>VBIF, VBIT, VBSL</i> on page A8-550

A4.13.3 Advanced SIMD comparison instructions

Table A4-18 shows Advanced SIMD comparison instructions.

Table A4-18 Advanced SIMD comparison instructions

Instruction	See
Vector Absolute Compare	<i>VACGE, VACGT, VACLE, VACL</i> T on page A8-534
Vector Compare Equal	<i>VCEQ</i> (<i>register</i>) on page A8-552
Vector Compare Equal to Zero	<i>VCEQ</i> (<i>immediate #0</i>) on page A8-554
Vector Compare Greater Than or Equal	<i>VCGE</i> (<i>register</i>) on page A8-556
Vector Compare Greater Than or Equal to Zero	<i>VCGE</i> (<i>immediate #0</i>) on page A8-558
Vector Compare Greater Than	<i>VCGT</i> (<i>register</i>) on page A8-560
Vector Compare Greater Than Zero	<i>VCGT</i> (<i>immediate #0</i>) on page A8-562
Vector Compare Less Than or Equal to Zero	<i>VCLE</i> (<i>immediate #0</i>) on page A8-564
Vector Compare Less Than Zero	<i>VCLT</i> (<i>immediate #0</i>) on page A8-568
Vector Test Bits	<i>VTST</i> on page A8-802

A4.13.4 Advanced SIMD shift instructions

Table A4-19 lists the shift instructions in the Advanced SIMD instruction set.

Table A4-19 Advanced SIMD shift instructions

Instruction	See
Vector Saturating Rounding Shift Left	<i>VQRSHL</i> on page A8-714
Vector Saturating Rounding Shift Right and Narrow	<i>VQRSHRN</i> , <i>VQRSHRUN</i> on page A8-716
Vector Saturating Shift Left	<i>VQSHL</i> (<i>register</i>) on page A8-718 <i>VQSHL</i> , <i>VQSHLU</i> (<i>immediate</i>) on page A8-720
Vector Saturating Shift Right and Narrow	<i>VQSHRN</i> , <i>VQSHRUN</i> on page A8-722
Vector Rounding Shift Left	<i>VRSHL</i> on page A8-736
Vector Rounding Shift Right	<i>VRSHR</i> on page A8-738
Vector Rounding Shift Right and Accumulate	<i>VRSRA</i> on page A8-746
Vector Rounding Shift Right and Narrow	<i>VRSHRN</i> on page A8-740
Vector Shift Left	<i>VSHL</i> (<i>immediate</i>) on page A8-750 <i>VSHL</i> (<i>register</i>) on page A8-752
Vector Shift Left Long	<i>VSHLL</i> on page A8-754
Vector Shift Right	<i>VSHR</i> on page A8-756
Vector Shift Right and Narrow	<i>VSHRN</i> on page A8-758
Vector Shift Left and Insert	<i>VSLI</i> on page A8-760
Vector Shift Right and Accumulate	<i>VSRA</i> on page A8-764
Vector Shift Right and Insert	<i>VSRI</i> on page A8-766

A4.13.5 Advanced SIMD multiply instructions

Table A4-20 summarizes the Advanced SIMD multiply instructions.

Table A4-20 Advanced SIMD multiply instructions

Instruction	See
Vector Multiply Accumulate	<i>VMLA, VMLAL, VMLS, VMLSL (integer)</i> on page A8-634
Vector Multiply Accumulate Long	<i>VMLA, VMLS (floating-point)</i> on page A8-636
Vector Multiply Subtract	<i>VMLA, VMLAL, VMLS, VMLSL (by scalar)</i> on page A8-638
Vector Multiply Subtract Long	
Vector Multiply	<i>VMUL, VMULL (integer and polynomial)</i> on page A8-662
Vector Multiply Long	<i>VMUL (floating-point)</i> on page A8-664 <i>VMUL, VMULL (by scalar)</i> on page A8-666
Vector Saturating Doubling Multiply Accumulate Long	<i>VQDMLAL, VQDMLSL</i> on page A8-702
Vector Saturating Doubling Multiply Subtract Long	
Vector Saturating Doubling Multiply Returning High Half	<i>VQDMULH</i> on page A8-704
Vector Saturating Rounding Doubling Multiply Returning High Half	<i>VQRDMULH</i> on page A8-712
Vector Saturating Doubling Multiply Long	<i>VQDMULL</i> on page A8-706

Advanced SIMD multiply instructions can operate on vectors of:

- 8-bit, 16-bit, or 32-bit unsigned integers
- 8-bit, 16-bit, or 32-bit signed integers
- 8-bit or 16-bit polynomials over $\{0,1\}$ (*VMUL* and *VMULL* only)
- single-precision (32-bit) floating-point numbers.

They can also act on one vector and one scalar.

Long instructions have doubleword (64-bit) operands, and produce quadword (128-bit) results. Other Advanced SIMD multiply instructions can have either doubleword or quadword operands, and produce results of the same size.

VFP multiply instructions can operate on:

- single-precision (32-bit) floating-point numbers
- double-precision (64-bit) floating-point numbers.

Some VFP implementations do not support double-precision numbers.

A4.13.6 Miscellaneous Advanced SIMD data-processing instructions

Table A4-21 shows miscellaneous Advanced SIMD data-processing instructions.

Table A4-21 Miscellaneous Advanced SIMD data-processing instructions

Instruction	See
Vector Absolute Difference and Accumulate	<i>VABA</i> , <i>VABAL</i> on page A8-526
Vector Absolute Difference	<i>VABD</i> , <i>VABDL</i> (<i>integer</i>) on page A8-528 <i>VABD</i> (<i>floating-point</i>) on page A8-530
Vector Absolute	<i>VABS</i> on page A8-532
Vector Convert between floating-point and fixed point	<i>VCVT</i> (<i>between floating-point and fixed-point, Advanced SIMD</i>) on page A8-580
Vector Convert between floating-point and integer	<i>VCVT</i> (<i>between floating-point and integer, Advanced SIMD</i>) on page A8-576
Vector Convert between half-precision and single-precision	<i>VCVT</i> (<i>between half-precision and single-precision, Advanced SIMD</i>) on page A8-586
Vector Count Leading Sign Bits	<i>VCLS</i> on page A8-566
Vector Count Leading Zeros	<i>VCLZ</i> on page A8-570
Vector Count Set Bits	<i>VCNT</i> on page A8-574
Vector Duplicate scalar	<i>VDUP</i> (<i>scalar</i>) on page A8-592
Vector Extract	<i>VEXT</i> on page A8-598
Vector Move and Narrow	<i>VMOVN</i> on page A8-656
Vector Move Long	<i>VMOVL</i> on page A8-654
Vector Maximum, Minimum	<i>VMAX</i> , <i>VMIN</i> (<i>integer</i>) on page A8-630 <i>VMAX</i> , <i>VMIN</i> (<i>floating-point</i>) on page A8-632
Vector Negate	<i>VNEG</i> on page A8-672
Vector Pairwise Maximum, Minimum	<i>VPMAX</i> , <i>VPMIN</i> (<i>integer</i>) on page A8-690 <i>VPMAX</i> , <i>VPMIN</i> (<i>floating-point</i>) on page A8-692
Vector Reciprocal Estimate	<i>VRECPE</i> on page A8-728
Vector Reciprocal Step	<i>VRECPS</i> on page A8-730
Vector Reciprocal Square Root Estimate	<i>VRSQRTE</i> on page A8-742

Table A4-21 Miscellaneous Advanced SIMD data-processing instructions (continued)

Instruction	See
Vector Reciprocal Square Root Step	<i>VRSQRTS</i> on page A8-744
Vector Reverse	<i>VREV16</i> , <i>VREV32</i> , <i>VREV64</i> on page A8-732
Vector Saturating Absolute	<i>VQABS</i> on page A8-698
Vector Saturating Move and Narrow	<i>VQMOVN</i> , <i>VQMOVUN</i> on page A8-708
Vector Saturating Negate	<i>VQNEG</i> on page A8-710
Vector Swap	<i>VSWP</i> on page A8-796
Vector Table Lookup	<i>VTBL</i> , <i>VTBX</i> on page A8-798
Vector Transpose	<i>VTRN</i> on page A8-800
Vector Unzip	<i>VUZP</i> on page A8-804
Vector Zip	<i>VZIP</i> on page A8-806

A4.14 VFP data-processing instructions

Table A4-22 summarizes the data-processing instructions in the VFP instruction set.

For details of the floating-point arithmetic used by VFP instructions, see *Floating-point data types and arithmetic* on page A2-32.

Table A4-22 VFP data-processing instructions

Instruction	See
Absolute value	<i>VABS</i> on page A8-532
Add	<i>VADD (floating-point)</i> on page A8-538
Compare (optionally with exceptions enabled)	<i>VCMP, VCMPE</i> on page A8-572
Convert between floating-point and integer	<i>VCVT, VCVTR (between floating-point and integer, VFP)</i> on page A8-578
Convert between floating-point and fixed-point	<i>VCVT (between floating-point and fixed-point, VFP)</i> on page A8-582
Convert between double-precision and single-precision	<i>VCVT (between double-precision and single-precision)</i> on page A8-584
Convert between half-precision and single-precision	<i>VCVTB, VCVTT (between half-precision and single-precision, VFP)</i> on page A8-588
Divide	<i>VDIV</i> on page A8-590
Multiply Accumulate, Multiply Subtract	<i>VMLA, VMLS (floating-point)</i> on page A8-636
Move immediate value to extension register	<i>VMOV (immediate)</i> on page A8-640
Copy from one extension register to another	<i>VMOV (register)</i> on page A8-642
Multiply	<i>VMUL (floating-point)</i> on page A8-664
Negate (invert the sign bit)	<i>VNEG</i> on page A8-672
Multiply Accumulate and Negate, Multiply Subtract and Negate, Multiply and Negate	<i>VNMLA, VNMLS, VNMUL</i> on page A8-674
Square Root	<i>VSQRT</i> on page A8-762
Subtract	<i>VSUB (floating-point)</i> on page A8-790

Chapter A5

ARM Instruction Set Encoding

This chapter describes the encoding of the ARM instruction set. It contains the following sections:

- *ARM instruction set encoding* on page A5-2
- *Data-processing and miscellaneous instructions* on page A5-4
- *Load/store word and unsigned byte* on page A5-19
- *Media instructions* on page A5-21
- *Branch, branch with link, and block data transfer* on page A5-27
- *Supervisor Call, and coprocessor instructions* on page A5-28
- *Unconditional instructions* on page A5-30.

Note

- Architecture variant information in this chapter describes the architecture variant or extension in which the instruction encoding was introduced into the ARM instruction set. *All* means that the instruction encoding was introduced in ARMv4 or earlier, and so is in all variants of the ARM instruction set covered by this manual.
 - In the decode tables in this chapter, an entry of - for a field value means the value of the field does not affect the decoding.
-

A5.1 ARM instruction set encoding

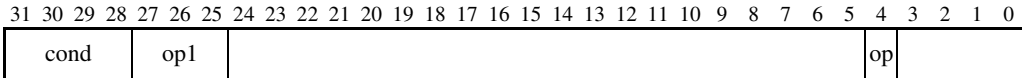

The ARM instruction stream is a sequence of word-aligned words. Each ARM instruction is a single 32-bit word in that stream.

Table A5-1 shows the major subdivisions of the ARM instruction set, determined by bits [31:25,4].

Most ARM instructions can be conditional, with a condition determined by bits [31:28] of the instruction, the cond field. For details see *The condition field*. This applies to all instructions except those with the cond field equal to 0b1111.

Table A5-1 ARM instruction encoding

cond	op1	op	Instruction classes
not 1111	00x	-	<i>Data-processing and miscellaneous instructions on page A5-4.</i>
	010	-	<i>Load/store word and unsigned byte on page A5-19.</i>
	011	0	<i>Load/store word and unsigned byte on page A5-19.</i>
		1	<i>Media instructions on page A5-21.</i>
	10x	-	<i>Branch, branch with link, and block data transfer on page A5-27.</i>
	11x	-	<i>Supervisor Call, and coprocessor instructions on page A5-28.</i> Includes VFP instructions and Advanced SIMD data transfers, see Chapter A7 <i>Advanced SIMD and VFP Instruction Encoding</i> .
1111	-	-	If the cond field is 0b1111, the instruction can only be executed unconditionally, see <i>Unconditional instructions on page A5-30.</i> Includes Advanced SIMD instructions, see Chapter A7 <i>Advanced SIMD and VFP Instruction Encoding</i> .

A5.1.1 The condition field

Every conditional instruction contains a 4-bit condition code field in bits 31 to 28:

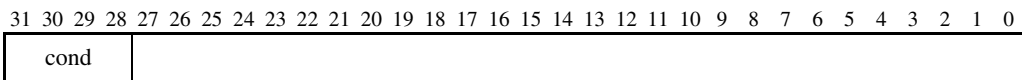

This field contains one of the values 0b0000-0b1110 described in Table A8-1 on page A8-8. Most instruction mnemonics can be extended with the letters defined in the mnemonic extension field.

If the *always* (AL) condition is specified, the instruction is executed irrespective of the value of the condition code flags. The absence of a condition code on an instruction mnemonic implies the AL condition code.

A5.1.2 UNDEFINED and UNPREDICTABLE instruction set space

An attempt to execute an unallocated instruction results in either:

- Unpredictable behavior. The instruction is described as UNPREDICTABLE.
- An Undefined Instruction exception. The instruction is described as UNDEFINED.

An instruction is UNDEFINED if it is declared as UNDEFINED in an instruction description, or in this chapter.

An instruction is UNPREDICTABLE if:

- it is declared as UNPREDICTABLE in an instruction description or in this chapter
- the pseudocode for that encoding does not indicate that a different special case applies, and a bit marked (0) or (1) in the encoding diagram of an instruction is not 0 or 1 respectively.

Unless otherwise specified:

- ARM instructions introduced in an architecture variant are UNDEFINED in earlier architecture variants.
- ARM instructions introduced in one or more architecture extensions are UNDEFINED if none of those extensions are implemented.

A5.1.3 The PC and the use of 0b1111 as a register specifier

In ARM instructions, the use of 0b1111 as a register specifier specifies the PC.

Many instructions are UNPREDICTABLE if they use 0b1111 as a register specifier. This is specified by pseudocode in the instruction description.

———— **Note** —————

Use of the PC as the base register in any store instruction is deprecated in ARMv7.

A5.1.4 The SP and the use of 0b1101 as a register specifier

In ARM instructions, the use of 0b1101 as a register specifier specifies the SP.

ARM deprecates:

- using SP for any purpose other than as a stack pointer
- using the SP in ARM instructions in ways other than those listed in *32-bit Thumb instruction support for R13* on page A6-4, except that ARM does not deprecate the use of instructions of the following form that write a word-aligned address to SP:

```
SUB SP, <Rd>, #<const>
```

A5.2 Data-processing and miscellaneous instructions

31	30	29	28	27	26	25	24	23	22	21	20	19	18	17	16	15	14	13	12	11	10	9	8	7	6	5	4	3	2	1	0
cond				0	0	op	op1										op2														

Table A5-2 shows the allocation of encodings in this space.

Table A5-2 Data-processing and miscellaneous instructions

op	op1	op2	Instruction or instruction class	Variant
0	not 10xx0	xxx0	<i>Data-processing (register)</i> on page A5-5	-
		0xx1	<i>Data-processing (register-shifted register)</i> on page A5-7	-
	10xx0	0xxx	<i>Miscellaneous instructions</i> on page A5-18	-
		1xx0	<i>Halfword multiply and multiply-accumulate</i> on page A5-13	-
	0xxxx	1001	<i>Multiply and multiply-accumulate</i> on page A5-12	-
	1xxxx	1001	<i>Synchronization primitives</i> on page A5-16	-
	not 0xx1x	1011	<i>Extra load/store instructions</i> on page A5-14	-
		11x1	<i>Extra load/store instructions</i> on page A5-14	-
	0xx1x	1011	<i>Extra load/store instructions (unprivileged)</i> on page A5-15	-
		11x1	<i>Extra load/store instructions (unprivileged)</i> on page A5-15	-
1	not 10xx0	-	<i>Data-processing (immediate)</i> on page A5-8	-
	10000	-	16-bit immediate load (<i>MOV (immediate)</i>) on page A8-194	v6T2
	10100	-	High halfword 16-bit immediate load (<i>MOVT</i>) on page A8-200	v6T2
	10x10	-	<i>MSR (immediate), and hints</i> on page A5-17	-

A5.2.1 Data-processing (register)

31	30	29	28	27	26	25	24	23	22	21	20	19	18	17	16	15	14	13	12	11	10	9	8	7	6	5	4	3	2	1	0
cond	0	0	0	op1								op2								op3	0										

If op1 == 0b10xx0, see *Data-processing and miscellaneous instructions* on page A5-4.

Table A5-3 shows the allocation of encodings in this space. These encodings are in all architecture variants.

Table A5-3 Data-processing (register) instructions

op1	op2	op3	Instruction	See
0000x	-	-	Bitwise AND	<i>AND (register)</i> on page A8-36
0001x	-	-	Bitwise Exclusive OR	<i>EOR (register)</i> on page A8-96
0010x	-	-	Subtract	<i>SUB (register)</i> on page A8-422
0011x	-	-	Reverse Subtract	<i>RSB (register)</i> on page A8-286
0100x	-	-	Add	<i>ADD (register)</i> on page A8-24
0101x	-	-	Add with Carry	<i>ADC (register)</i> on page A8-16
0110x	-	-	Subtract with Carry	<i>SBC (register)</i> on page A8-304
0111x	-	-	Reverse Subtract with Carry	<i>RSC (register)</i> on page A8-292
10001	-	-	Test	<i>TST (register)</i> on page A8-456
10011	-	-	Test Equivalence	<i>TEQ (register)</i> on page A8-450
10101	-	-	Compare	<i>CMP (register)</i> on page A8-82
10111	-	-	Compare Negative	<i>CMN (register)</i> on page A8-76
1100x	-	-	Bitwise OR	<i>ORR (register)</i> on page A8-230
1101x	00000	00	Move	<i>MOV (register)</i> on page A8-196
	not 00000	00	Logical Shift Left	<i>LSL (immediate)</i> on page A8-178
	-	01	Logical Shift Right	<i>LSR (immediate)</i> on page A8-182
	-	10	Arithmetic Shift Right	<i>ASR (immediate)</i> on page A8-40
	00000	11	Rotate Right with Extend	<i>RRX</i> on page A8-282
	not 00000	11	Rotate Right	<i>ROR (immediate)</i> on page A8-278

Table A5-3 Data-processing (register) instructions (continued)

op1	op2	op3	Instruction	See
1110x	-	-	Bitwise Bit Clear	<i>BIC (register)</i> on page A8-52
1111x	-	-	Bitwise NOT	<i>MVN (register)</i> on page A8-216

A5.2.2 Data-processing (register-shifted register)

31	30	29	28	27	26	25	24	23	22	21	20	19	18	17	16	15	14	13	12	11	10	9	8	7	6	5	4	3	2	1	0
cond			0 0 0			op1										0	op2		1												

If op1 == 0b10xx0, see *Data-processing and miscellaneous instructions* on page A5-4.

Table A5-4 shows the allocation of encodings in this space. These encodings are in all architecture variants.

Table A5-4 Data-processing (register-shifted register) instructions

op1	op2	Instruction	See
0000x	-	Bitwise AND	<i>AND</i> (register-shifted register) on page A8-38
0001x	-	Bitwise Exclusive OR	<i>EOR</i> (register-shifted register) on page A8-98
0010x	-	Subtract	<i>SUB</i> (register-shifted register) on page A8-424
0011x	-	Reverse Subtract	<i>RSB</i> (register-shifted register) on page A8-288
0100x	-	Add	<i>ADD</i> (register-shifted register) on page A8-26
0101x	-	Add with Carry	<i>ADC</i> (register-shifted register) on page A8-18
0110x	-	Subtract with Carry	<i>SBC</i> (register-shifted register) on page A8-306
0111x	-	Reverse Subtract with Carry	<i>RSC</i> (register-shifted register) on page A8-294
10001	-	Test	<i>TST</i> (register-shifted register) on page A8-458
10011	-	Test Equivalence	<i>TEQ</i> (register-shifted register) on page A8-452
10101	-	Compare	<i>CMP</i> (register-shifted register) on page A8-84
10111	-	Compare Negative	<i>CMN</i> (register-shifted register) on page A8-78
1100x	-	Bitwise OR	<i>ORR</i> (register-shifted register) on page A8-232
1101x	00	Logical Shift Left	<i>LSL</i> (register) on page A8-180
	01	Logical Shift Right	<i>LSR</i> (register) on page A8-184
	10	Arithmetic Shift Right	<i>ASR</i> (register) on page A8-42
	11	Rotate Right	<i>ROR</i> (register) on page A8-280
1110x	-	Bitwise Bit Clear	<i>BIC</i> (register-shifted register) on page A8-54
1111x	-	Bitwise NOT	<i>MVN</i> (register-shifted register) on page A8-218

A5.2.3 Data-processing (immediate)

31	30	29	28	27	26	25	24	23	22	21	20	19	18	17	16	15	14	13	12	11	10	9	8	7	6	5	4	3	2	1	0
cond				0 0 1			op				Rn																				

If op == 0b10xx0, see *Data-processing and miscellaneous instructions* on page A5-4.

Table A5-5 shows the allocation of encodings in this space. These encodings are in all architecture variants.

Table A5-5 Data-processing (immediate) instructions

op	Rn	Instruction	See
0000x	-	Bitwise AND	<i>AND (immediate)</i> on page A8-34
0001x	-	Bitwise Exclusive OR	<i>EOR (immediate)</i> on page A8-94
0010x	not 1111	Subtract	<i>SUB (immediate, ARM)</i> on page A8-420
	1111	Form PC-relative address	<i>ADR</i> on page A8-32
0011x	-	Reverse Subtract	<i>RSB (immediate)</i> on page A8-284
0100x	not 1111	Add	<i>ADD (immediate, ARM)</i> on page A8-22
	1111	Form PC-relative address	<i>ADR</i> on page A8-32
0101x	-	Add with Carry	<i>ADC (immediate)</i> on page A8-14
0110x	-	Subtract with Carry	<i>SBC (immediate)</i> on page A8-302
0111x	-	Reverse Subtract with Carry	<i>RSC (immediate)</i> on page A8-290
10001	-	Test	<i>TST (immediate)</i> on page A8-454
10011	-	Test Equivalence	<i>TEQ (immediate)</i> on page A8-448
10101	-	Compare	<i>CMP (immediate)</i> on page A8-80
10111	-	Compare Negative	<i>CMN (immediate)</i> on page A8-74
1100x	-	Bitwise OR	<i>ORR (immediate)</i> on page A8-228
1101x	-	Move	<i>MOV (immediate)</i> on page A8-194
1110x	-	Bitwise Bit Clear	<i>BIC (immediate)</i> on page A8-50
1111x	-	Bitwise NOT	<i>MVN (immediate)</i> on page A8-214

These instructions all have modified immediate constants, rather than a simple 12-bit binary number. This provides a more useful range of values. For details see *Modified immediate constants in ARM instructions* on page A5-9.

A5.2.4 Modified immediate constants in ARM instructions

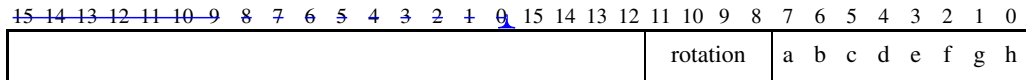

Table A5-6 shows the range of modified immediate constants available in ARM data-processing instructions, and how they are encoded in the a, b, c, d, e, f, g, h, and rotation fields in the instruction.

Table A5-6 Encoding of modified immediates in ARM processing instructions

rotation	<const> ^a
0000	00000000 00000000 00000000 abcdefgh
0001	gh000000 00000000 00000000 00abcdef
0010	efgh0000 00000000 00000000 0000abcd
0011	cdefgh00 00000000 00000000 000000ab
0100	abcdefgh 00000000 00000000 00000000
.	.
.	. 8-bit values shifted to other even-numbered positions
.	.
1001	00000000 00abcdef gh000000 00000000
.	.
.	. 8-bit values shifted to other even-numbered positions
.	.
1110	00000000 00000000 0000abcd efgh0000
1111	00000000 00000000 000000ab cdefgh00

- a. In this table, the immediate constant value is shown in binary form, to relate abcdefgh to the encoding diagram. In assembly syntax, the immediate value is specified in the usual way (a decimal number by default).

Note

The range of values available in ARM modified immediate constants is slightly different from the range of values available in 32-bit Thumb instructions. See *Modified immediate constants in Thumb instructions* on page A6-17.

Carry out

A logical instruction with rotation == 0b0000 does not affect APSR.C. Otherwise, a logical instruction that sets the flags sets APSR.C to the value of bit [31] of the modified immediate constant.

Constants with multiple encodings

Some constant values have multiple possible encodings. In this case, a UAL assembler must select the encoding with the lowest unsigned value of the rotation field. This is the encoding that appears first in Table A5-6 on page A5-9. For example, the constant #3 must be encoded with (rotation, abcdefgh) == (0b0000, 0b00000011), not (0b0001, 0b00001100), (0b0010, 0b00110000), or (0b0011, 0b11000000).

In particular, this means that all constants in the range 0-255 are encoded with rotation == 0b0000, and permitted constants outside that range are encoded with rotation != 0b0000. A flag-setting logical instruction with a modified immediate constant therefore leaves APSR.C unchanged if the constant is in the range 0-255 and sets it to the most significant bit of the constant otherwise. This matches the behavior of Thumb modified immediate constants for all constants that are permitted in both the ARM and Thumb instruction sets.

An alternative syntax is available for a modified immediate constant that permits the programmer to specify the encoding directly. In this syntax, #<const> is instead written as #<byte>, #<rot>, where:

<byte> is the numeric value of abcdefgh, in the range 0-255

<rot> is twice the numeric value of rotation, an even number in the range 0-30.

This syntax permits all ARM data-processing instructions with modified immediate constants to be disassembled to assembler syntax that will assemble to the original instruction.

This syntax also makes it possible to write variants of some flag-setting logical instructions that have different effects on APSR.C to those obtained with the normal #<const> syntax. For example, ANDS R1, R2, #12, #2 has the same behavior as ANDS R1, R2, #3 except that it sets APSR.C to 0 instead of leaving it unchanged. Such variants of flag-setting logical instructions do not have equivalents in the Thumb instruction set, and their use is deprecated.

Operation

```
// ARMEExpandImm()
// =====

bits(32) ARMEExpandImm(bits(12) imm12)

    // APSR.C argument to following function call does not affect the imm32 result.
    (imm32, -) = ARMEExpandImm_C(imm12, APSR.C);

    return imm32;

// ARMEExpandImm_C()
// =====

(bits(32), bit) ARMEExpandImm_C(bits(12) imm12, bit carry_in)
```



```
unrotated_value = ZeroExtend(imm12<7:0>, 32);  
(imm32, carry_out) = Shift_C(unrotated_value, SRTYPE_ROR, 2*UInt(imm12<11:8>), carry_in);  
  
return (imm32, carry_out);
```

A5.2.5 Multiply and multiply-accumulate

31	30	29	28	27	26	25	24	23	22	21	20	19	18	17	16	15	14	13	12	11	10	9	8	7	6	5	4	3	2	1	0
cond	0	0	0	0	op													1	0	0	1										

Table A5-7 shows the allocation of encodings in this space.

Table A5-7 Multiply and multiply-accumulate instructions

op	Instruction	See	Variant
000x	Multiply	<i>MUL</i> on page A8-212	All
001x	Multiply Accumulate	<i>MLA</i> on page A8-190	All
0100	Unsigned Multiply Accumulate Accumulate Long	<i>UMAAL</i> on page A8-482	v6
0101	UNDEFINED	-	-
0110	Multiply and Subtract	<i>MLS</i> on page A8-192	v6T2
0111	UNDEFINED	-	-
100x	Unsigned Multiply Long	<i>UMULL</i> on page A8-486	All
101x	Unsigned Multiply Accumulate Long	<i>UMLAL</i> on page A8-484	All
110x	Signed Multiply Long	<i>SMULL</i> on page A8-356	All
111x	Signed Multiply Accumulate Long	<i>SMLAL</i> on page A8-334	All

A5.2.6 Saturating addition and subtraction

31	30	29	28	27	26	25	24	23	22	21	20	19	18	17	16	15	14	13	12	11	10	9	8	7	6	5	4	3	2	1	0				
cond		0	0	0	1	0	op		0														0	1	0	1									

Table A5-8 shows the allocation of encodings in this space. These encodings are all available in ARMv5TE and above, and are UNDEFINED in earlier variants of the architecture.

Table A5-8 Saturating addition and subtraction instructions

op	Instruction	See
00	Saturating Add	<i>QADD</i> on page A8-250
01	Saturating Subtract	<i>QSUB</i> on page A8-264
10	Saturating Double and Add	<i>QDADD</i> on page A8-258
11	Saturating Double and Subtract	<i>QDSUB</i> on page A8-260

A5.2.7 Halfword multiply and multiply-accumulate

31	30	29	28	27	26	25	24	23	22	21	20	19	18	17	16	15	14	13	12	11	10	9	8	7	6	5	4	3	2	1	0			
cond		0	0	0	1	0	op1		0														1			op	0							

Table A5-9 shows the allocation of encodings in this space.

These encodings are signed multiply (SMUL) and signed multiply-accumulate (SMLA) instructions, operating on 16-bit values, or mixed 16-bit and 32-bit values. The results and accumulators are 32-bit or 64-bit.

These encodings are all available in ARMv5TE and above, and are UNDEFINED in earlier variants of the architecture.

Table A5-9 Halfword multiply and multiply-accumulate instructions

op1	op	Instruction	See
00	-	Signed 16-bit multiply, 32-bit accumulate	<i>SMLABB</i> , <i>SMLABT</i> , <i>SMLATB</i> , <i>SMLATT</i> on page A8-330
01	0	Signed 16-bit x 32-bit multiply, 32-bit accumulate	<i>SMLAWB</i> , <i>SMLAWT</i> on page A8-340
01	1	Signed 16-bit x 32-bit multiply, 32-bit result	<i>SMULWB</i> , <i>SMULWT</i> on page A8-358
10	-	Signed 16-bit multiply, 64-bit accumulate	<i>SMLALBB</i> , <i>SMLALBT</i> , <i>SMLALTB</i> , <i>SMLALTT</i> on page A8-336
11	-	Signed 16-bit multiply, 32-bit result	<i>SMULBB</i> , <i>SMULBT</i> , <i>SMULTB</i> , <i>SMULTT</i> on page A8-354

A5.2.8 Extra load/store instructions

31	30	29	28	27	26	25	24	23	22	21	20	19	18	17	16	15	14	13	12	11	10	9	8	7	6	5	4	3	2	1	0
cond			0	0	0	op1			Rn						1	op2		1													

If op1 == 0b0xx1x or op2 == 0b00, see *Data-processing and miscellaneous instructions* on page A5-4.

Table A5-10 shows the allocation of encodings in this space.

Table A5-10 Extra load/store instructions

op2	op1	Rn	Instruction	See	Variant
01	xx0x0	-	Store Halfword	<i>STRH (register)</i> on page A8-412	All
	xx0x1	-	Load Halfword	<i>LDRH (register)</i> on page A8-156	All
	xx1x0	-	Store Halfword	<i>STRH (immediate, ARM)</i> on page A8-410	All
	xx1x1	not 1111	Load Halfword	<i>LDRH (immediate, ARM)</i> on page A8-152	All
		1111	Load Halfword	<i>LDRH (literal)</i> on page A8-154	All
10	xx0x0	-	Load Dual	<i>LDRD (register)</i> on page A8-140	v5TE
	xx0x1	-	Load Signed Byte	<i>LDRSB (register)</i> on page A8-164	All
	xx1x0	not 1111	Load Dual	<i>LDRD (immediate)</i> on page A8-136	v5TE
		1111	Load Dual	<i>LDRD (literal)</i> on page A8-138	v5TE
	xx1x1	not 1111	Load Signed Byte	<i>LDRSB (immediate)</i> on page A8-160	All
		1111	Load Signed Byte	<i>LDRSB (literal)</i> on page A8-162	All
11	xx0x0	-	Store Dual	<i>STRD (register)</i> on page A8-398	All
	xx0x1	-	Load Signed Halfword	<i>LDRSH (register)</i> on page A8-172	All
	xx1x0	-	Store Dual	<i>STRD (immediate)</i> on page A8-396	All
	xx1x1	not 1111	Load Signed Halfword	<i>LDRSH (immediate)</i> on page A8-168	All
		1111	Load Signed Halfword	<i>LDRSH (literal)</i> on page A8-170	All

A5.2.9 Extra load/store instructions (unprivileged)

	31	30	29	28	27	26	25	24	23	22	21	20	19	18	17	16	15	14	13	12	11	10	9	8	7	6	5	4	3	2	1	0
	cond				0	0	0	0		1	op														1	op2	1					

If op2 == 0b00, see *Data-processing and miscellaneous instructions* on page A5-4.

Table A5-11 shows the allocation of encodings in this space. The instruction encodings are all available in ARMv6T2 and above, and are UNDEFINED in earlier variants of the architecture.

Table A5-11 Extra load/store instructions (unprivileged)

op2	op	Rt	Instruction	See
01	0	-	Store Halfword Unprivileged	<i>STRHT</i> on page A8-414
	1	-	Load Halfword Unprivileged	<i>LDRHT</i> on page A8-158
1x	0	xxx0	UNPREDICTABLE	-
		xxx1	UNDEFINED	-
10	1	-	Load Signed Byte Unprivileged	<i>LDRSBT</i> on page A8-166
11	1	-	Load Signed Halfword Unprivileged	<i>LDRSHT</i> on page A8-174

A5.2.10 Synchronization primitives

31	30	29	28	27	26	25	24	23	22	21	20	19	18	17	16	15	14	13	12	11	10	9	8	7	6	5	4	3	2	1	0
cond				0 0 0 1				op								1 0 0 1															

Table A5-12 shows the allocation of encodings in this space.

Other encodings in this space are UNDEFINED.

Table A5-12 Synchronization primitives

op	Instruction	See	Variant
0x00	Swap Word, Swap Byte	<i>SWP, SWPB</i> on page A8-432 ^a	All
1000	Store Register Exclusive	<i>STREX</i> on page A8-400	v6
1001	Load Register Exclusive	<i>LDREX</i> on page A8-142	v6
1010	Store Register Exclusive Doubleword	<i>STREXD</i> on page A8-404	v6K
1011	Load Register Exclusive Doubleword	<i>LDREXD</i> on page A8-146	v6K
1100	Store Register Exclusive Byte	<i>STREXB</i> on page A8-402	v6K
1101	Load Register Exclusive Byte	<i>LDREXB</i> on page A8-144	v6K
1110	Store Register Exclusive Halfword	<i>STREXH</i> on page A8-406	v6K
1111	Load Register Exclusive Halfword	<i>LDREXH</i> on page A8-148	v6K

a. Use of these instructions is deprecated.

A5.2.11 MSR (immediate), and hints

31	30	29	28	27	26	25	24	23	22	21	20	19	18	17	16	15	14	13	12	11	10	9	8	7	6	5	4	3	2	1	0
cond				0 0 1 1 0				op	1 0		op1								op2												

Table A5-13 shows the allocation of encodings in this space.

Other encodings in this space are unallocated hints. They execute as NOPs, but software must not use them.

Table A5-13 MSR (immediate), and hints

op	op1	op2	Instruction	See	Variant
0	0000	00000000	No Operation hint	<i>NOP</i> on page A8-222	v6K, v6T2
		00000001	Yield hint	<i>YIELD</i> on page A8-812	v6K
		00000010	Wait For Event hint	<i>WFE</i> on page A8-808	v6K
		00000011	Wait For Interrupt hint	<i>WFI</i> on page A8-810	v6K
		00000100	Send Event hint	<i>SEV</i> on page A8-316	v6K
		1111xxxx	Debug hint	<i>DBG</i> on page A8-88	v7
	0100	-	Move to Special Register, application level	<i>MSR (immediate)</i> on page A8-208	All
	1x00	-			
	xx01	-	Move to Special Register, system level	<i>MSR (immediate)</i> on page B6-12	All
	xx1x	-			
1	-	-	Move to Special Register, system level	<i>MSR (immediate)</i> on page B6-12	All

A5.2.12 Miscellaneous instructions

Table A5-14 shows the allocation of encodings in this space.

Other encodings in this space are UNDEFINED.

Table A5-14 Miscellaneous instructions

op2	op	op1	Instruction or instruction class	See	Variant
000	x0	xxxx	Move Special Register to Register	<i>MRS</i> on page A8-206 <i>MRS</i> on page B6-10	All
	01	xx00	Move to Special Register, application level	<i>MSR (register)</i> on page A8-210	All
		xx01 xx1x	Move to Special Register, system level	<i>MSR (register)</i> on page B6-14	All
	11	-	Move to Special Register, system level	<i>MSR (register)</i> on page B6-14	All
001	01	-	Branch and Exchange	<i>BX</i> on page A8-62	v4T
	11	-	Count Leading Zeros	<i>CLZ</i> on page A8-72	v6
010	01	-	Branch and Exchange Jazelle	<i>BXJ</i> on page A8-64	v5TEJ
011	01	-	Branch with Link and Exchange	<i>BLX (register)</i> on page A8-60	v5T
101	-	-	Saturating addition and subtraction	<i>Saturating addition and subtraction</i> on page A5-13	-
111	01	-	Breakpoint	<i>BKPT</i> on page A8-56	v5T
	11	-	Secure Monitor Call	<i>SMC (previously SMI)</i> on page B6-18	Security Extensions

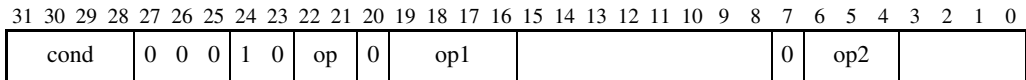
A5.3 Load/store word and unsigned byte

31	30	29	28	27	26	25	24	23	22	21	20	19	18	17	16	15	14	13	12	11	10	9	8	7	6	5	4	3	2	1	0
cond				0	1	A	op1				Rn								B												

These instructions have either A == 0 or B == 0. For instructions with A == 1 and B == 1, see *Media instructions* on page A5-21.

Table A5-15 shows the allocation of encodings in this space. These encodings are in all architecture variants.

Table A5-15 Single data transfer instructions

A	op1	B	Rn	Instruction	See
0	xx0x0 not 0x010	-	-	Store Register	<i>STR (immediate, ARM)</i> on page A8-384
1	xx0x0 not 0x010	0	-	Store Register	<i>STR (register)</i> on page A8-386
0	0x010	-	-	Store Register Unprivileged	<i>STRT</i> on page A8-416
1	0x010	0	-		
0	xx0x1 not 0x011	-	not 1111	Load Register (immediate)	<i>LDR (immediate, ARM)</i> on page A8-120
	xx0x1 not 0x011	-	1111	Load Register (literal)	<i>LDR (literal)</i> on page A8-122
1	xx0x1 not 0x011	0	-	Load Register	<i>LDR (register)</i> on page A8-124
0	0x011	-	-	Load Register Unprivileged	<i>LDRT</i> on page A8-176
1	0x011	0	-		
0	xx1x0 not 0x110	-	-	Store Register Byte (immediate)	<i>STRB (immediate, ARM)</i> on page A8-390
1	xx1x0 not 0x110	0	-	Store Register Byte (register)	<i>STRB (register)</i> on page A8-392
0	0x110	-	-	Store Register Byte Unprivileged	<i>STRBT</i> on page A8-394
1	0x110	0	-		
0	xx1x1 not 0x111	-	not 1111	Load Register Byte (immediate)	<i>LDRB (immediate, ARM)</i> on page A8-128
	xx1x1 not 0x111	-	1111	Load Register Byte (literal)	<i>LDRB (literal)</i> on page A8-130

Table A5-15 Single data transfer instructions (continued)

A	op1	B	Rn	Instruction	See
1	xx1x1 not 0x111	0	-	Load Register Byte (register)	<i>LDRB (register)</i> on page A8-132
0	0x111	-	-	Load Register Byte Unprivileged	<i>LDRBT</i> on page A8-134
1	0x111	0	-		

A5.4 Media instructions

31	30	29	28	27	26	25	24	23	22	21	20	19	18	17	16	15	14	13	12	11	10	9	8	7	6	5	4	3	2	1	0
cond				0	1	1	op1				Rd				op2				1	Rn											

Table A5-16 shows the allocation of encodings in this space.

Other encodings in this space are UNDEFINED.

Table A5-16 Media instructions

op1	op2	Rd	Rn	Instructions	See	Variant
000xx	-	-	-	-	<i>Parallel addition and subtraction, signed on page A5-22</i>	-
001xx	-	-	-	-	<i>Parallel addition and subtraction, unsigned on page A5-23</i>	-
01xxx	-	-	-	-	<i>Packing, unpacking, saturation, and reversal on page A5-24</i>	-
10xxx	-	-	-	-	<i>Signed multiplies on page A5-26</i>	-
11000	000	1111	-	Unsigned Sum of Absolute Differences	<i>USAD8 on page A8-500</i>	v6
	000	not 1111	-	Unsigned Sum of Absolute Differences and Accumulate	<i>USADA8 on page A8-502</i>	v6
1101x	x10	-	-	Signed Bit Field Extract	<i>SBFX on page A8-308</i>	v6T2
1110x	x00	-	1111	Bit Field Clear	<i>BFC on page A8-46</i>	v6T2
		-	not 1111	Bit Field Insert	<i>BFI on page A8-48</i>	v6T2
1111x	x10	-	-	Unsigned Bit Field Extract	<i>UBFX on page A8-466</i>	v6T2
11111	111	-	-	Permanently UNDEFINED. This space will not be allocated in future.		

A5.4.1 Parallel addition and subtraction, signed

31	30	29	28	27	26	25	24	23	22	21	20	19	18	17	16	15	14	13	12	11	10	9	8	7	6	5	4	3	2	1	0	
cond				0	1	1	0	0	0	op1																op2		1				

Table A5-17 shows the allocation of encodings in this space. These encodings are all available in ARMv6 and above, and are UNDEFINED in earlier variants of the architecture.

Other encodings in this space are UNDEFINED.

Table A5-17 Signed parallel addition and subtraction instructions

op1	op2	Instruction	See
01	000	Add 16-bit	<i>SADD16</i> on page A8-296
01	001	Add and Subtract with Exchange	<i>SASX</i> on page A8-300
01	010	Subtract and Add with Exchange	<i>SSAX</i> on page A8-366
01	011	Subtract 16-bit	<i>SSUB16</i> on page A8-368
01	100	Add 8-bit	<i>SADD8</i> on page A8-298
01	111	Subtract 8-bit	<i>SSUB8</i> on page A8-370
Saturating instructions			
10	000	Saturating Add 16-bit	<i>QADD16</i> on page A8-252
10	001	Saturating Add and Subtract with Exchange	<i>QASX</i> on page A8-256
10	010	Saturating Subtract and Add with Exchange	<i>QSAX</i> on page A8-262
10	011	Saturating Subtract 16-bit	<i>QSUB16</i> on page A8-266
10	100	Saturating Add 8-bit	<i>QADD8</i> on page A8-254
10	111	Saturating Subtract 8-bit	<i>QSUB8</i> on page A8-268
Halving instructions			
11	000	Halving Add 16-bit	<i>SHADD16</i> on page A8-318
11	001	Halving Add and Subtract with Exchange	<i>SHASX</i> on page A8-322
11	010	Halving Subtract and Add with Exchange	<i>SHSAX</i> on page A8-324
11	011	Halving Subtract 16-bit	<i>SHSUB16</i> on page A8-326
11	100	Halving Add 8-bit	<i>SHADD8</i> on page A8-320
11	111	Halving Subtract 8-bit	<i>SHSUB8</i> on page A8-328

A5.4.2 Parallel addition and subtraction, unsigned

31	30	29	28	27	26	25	24	23	22	21	20	19	18	17	16	15	14	13	12	11	10	9	8	7	6	5	4	3	2	1	0
cond				0	1	1	0	0	1	op1												op2		1							

Table A5-18 shows the allocation of encodings in this space. These encodings are all available in ARMv6 and above, and are UNDEFINED in earlier variants of the architecture.

Other encodings in this space are UNDEFINED.

Table A5-18 Unsigned parallel addition and subtractions instructions

op1	op2	Instruction	See
01	000	Add 16-bit	<i>UADD16</i> on page A8-460
01	001	Add and Subtract with Exchange	<i>UASX</i> on page A8-464
01	010	Subtract and Add with Exchange	<i>USAX</i> on page A8-508
01	011	Subtract 16-bit	<i>USUB16</i> on page A8-510
01	100	Add 8-bit	<i>UADD8</i> on page A8-462
01	111	Subtract 8-bit	<i>USUB8</i> on page A8-512
Saturating instructions			
10	000	Saturating Add 16-bit	<i>UQADD16</i> on page A8-488
10	001	Saturating Add and Subtract with Exchange	<i>UQASX</i> on page A8-492
10	010	Saturating Subtract and Add with Exchange	<i>UQSAX</i> on page A8-494
10	011	Saturating Subtract 16-bit	<i>UQSUB16</i> on page A8-496
10	100	Saturating Add 8-bit	<i>UQADD8</i> on page A8-490
10	111	Saturating Subtract 8-bit	<i>UQSUB8</i> on page A8-498
Halving instructions			
11	000	Halving Add 16-bit	<i>UHADD16</i> on page A8-470
11	001	Halving Add and Subtract with Exchange	<i>UHASX</i> on page A8-474
11	010	Halving Subtract and Add with Exchange	<i>UHSAX</i> on page A8-476
11	011	Halving Subtract 16-bit	<i>UHSUB16</i> on page A8-478
11	100	Halving Add 8-bit	<i>UHADD8</i> on page A8-472
11	111	Halving Subtract 8-bit	<i>UHSUB8</i> on page A8-480

A5.4.3 Packing, unpacking, saturation, and reversal

	31	30	29	28	27	26	25	24	23	22	21	20	19	18	17	16	15	14	13	12	11	10	9	8	7	6	5	4	3	2	1	0
	cond				0	1	1	0	1	op1				A								op2		1								

Table A5-19 shows the allocation of encodings in this space.

Other encodings in this space are UNDEFINED.

Table A5-19 Packing, unpacking, saturation, and reversal instructions

op1	op2	A	Instructions	See	Variant
000	xx0	-	Pack Halfword	<i>PKH</i> on page A8-234	v6
01x	xx0	-	Signed Saturate	<i>SSAT</i> on page A8-362	v6
11x	xx0	-	Unsigned Saturate	<i>USAT</i> on page A8-504	v6
000	011	not 1111	Signed Extend and Add Byte 16	<i>SXTAB16</i> on page A8-436	v6
		1111	Signed Extend Byte 16	<i>SXTB16</i> on page A8-442	v6
		101	Select Bytes	<i>SEL</i> on page A8-312	v6
010	001	-	Signed Saturate 16	<i>SSAT16</i> on page A8-364	v6
	011	not 1111	Signed Extend and Add Byte	<i>SXTAB</i> on page A8-434	v6
		1111	Signed Extend Byte	<i>SXTB</i> on page A8-440	v6
011	001	-	Byte-Reverse Word	<i>REV</i> on page A8-272	v6
	011	not 1111	Signed Extend and Add Halfword	<i>SXTAH</i> on page A8-438	v6
		1111	Signed Extend Halfword	<i>SXTH</i> on page A8-444	v6
011	101	-	Byte-Reverse Packed Halfword	<i>REV16</i> on page A8-274	v6
100	011	not 1111	Unsigned Extend and Add Byte 16	<i>UXTAB16</i> on page A8-516	v6
		1111	Unsigned Extend Byte 16	<i>UXTB16</i> on page A8-522	v6
110	001	-	Unsigned Saturate 16	<i>USAT16</i> on page A8-506	v6
	011	not 1111	Unsigned Extend and Add Byte	<i>UXTAB</i> on page A8-514	v6
		1111	Unsigned Extend Byte	<i>UXTB</i> on page A8-520	v6

Table A5-19 Packing, unpacking, saturation, and reversal instructions (continued)

op1	op2	A	Instructions	See	Variant
111	001	-	Reverse Bits	<i>RBIT</i> on page A8-270	v6T2
	011	not 1111	Unsigned Extend and Add Halfword	<i>UXTAH</i> on page A8-518	v6
		1111	Unsigned Extend Halfword	<i>UXTH</i> on page A8-524	v6
	101	-	Byte-Reverse Signed Halfword	<i>REVSH</i> on page A8-276	v6

A5.4.4 Signed multiplies

31	30	29	28	27	26	25	24	23	22	21	20	19	18	17	16	15	14	13	12	11	10	9	8	7	6	5	4	3	2	1	0
cond				0	1	1	1	0	op1				A				op2				1										

Table A5-20 shows the allocation of encodings in this space. These encodings are all available in ARMv6T2 and above, and are UNDEFINED in earlier variants of the architecture.

Other encodings in this space are UNDEFINED.

Table A5-20 Signed multiply instructions

op1	op2	A	Instruction	See
000	00x	not 1111	Signed Multiply Accumulate Dual	<i>SMLAD</i> on page A8-332
		1111	Signed Dual Multiply Add	<i>SMUAD</i> on page A8-352
	01x	not 1111	Signed Multiply Subtract Dual	<i>SMLSD</i> on page A8-342
		1111	Signed Dual Multiply Subtract	<i>SMUSD</i> on page A8-360
100	00x	-	Signed Multiply Accumulate Long Dual	<i>SMLALD</i> on page A8-338
	01x	-	Signed Multiply Subtract Long Dual	<i>SMLS LD</i> on page A8-344
101	00x	not 1111	Signed Most Significant Word Multiply Accumulate	<i>SMMLA</i> on page A8-346
		1111	Signed Most Significant Word Multiply	<i>SMMUL</i> on page A8-350
	11x	-	Signed Most Significant Word Multiply Subtract	<i>SMMLS</i> on page A8-348

A5.5 Branch, branch with link, and block data transfer

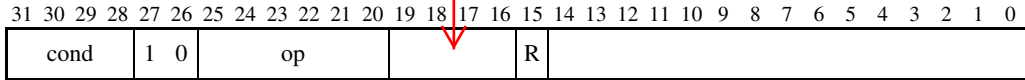

Table A5-21 shows the allocation of encodings in this space. These encodings are in all architecture variants.

Table A5-21 Branch, branch with link, and block data transfer instructions

op	R	Instructions	See
0000x0	-	Store Multiple Decrement After	<i>STMDA / STMED</i> on page A8-376
0000x1	-	Load Multiple Decrement After	<i>LDMDA / LDMFA</i> on page A8-112
0010x0	-	Store Multiple (Increment After)	<i>STM / STMIA / STMEA</i> on page A8-374
0010x1	-	Load Multiple (Increment After)	<i>LDM / LDMIA / LDMFD</i> on page A8-110
0100x0	-	Store Multiple Decrement Before	<i>STMDB / STMFD</i> on page A8-378
0100x1	-	Load Multiple Decrement Before	<i>LDMDB / LDMEA</i> on page A8-114
0110x0	-	Store Multiple Increment Before	<i>STMIB / STMFA</i> on page A8-380
0110x1	-	Load Multiple Increment Before	<i>LDMIB / LDMED</i> on page A8-116
0xx1x0	-	Store Multiple (user registers)	<i>STM (user registers)</i> on page B6-22
0xx1x1	0	Load Multiple (user registers)	<i>LDM (user registers)</i> on page B6-7
	1	Load Multiple (exception return)	<i>LDM (exception return)</i> on page B6-5
10xxxx	-	Branch	<i>B</i> on page A8-44
11xxxx	-	Branch with Link	<i>BL, BLX (immediate)</i> on page A8-58

A5.6 Supervisor Call, and coprocessor instructions

31	30	29	28	27	26	25	24	23	22	21	20	19	18	17	16	15	14	13	12	11	10	9	8	7	6	5	4	3	2	1	0
cond		1	1	op1				Rn				coproc				op															

Table A5-22 shows the allocation of encodings in this space.

Table A5-22 Supervisor Call, and coprocessor instructions

op1	op	coproc	Rn	Instructions	See	Variant
0xxxxx ^a	-	101x	-	Advanced SIMD, VFP	<i>Extension register load/store instructions on page A7-26</i>	
0xxxx0 ^a	-	not 101x	-	Store Coprocessor	<i>STC, STC2 on page A8-372</i>	All
0xxxx1 ^a	-	not 101x	not 1111	Load Coprocessor	<i>LDC, LDC2 (immediate) on page A8-106</i>	All
			1111	Load Coprocessor	<i>LDC, LDC2 (literal) on page A8-108</i>	All
00000x	-	-	-	UNDEFINED	-	-
00010x	-	101x	-	Advanced SIMD, VFP	<i>64-bit transfers between ARM core and extension registers on page A7-32</i>	
000100	-	not 101x	-	Move to Coprocessor from two ARM core registers	<i>MCRR, MCRR2 on page A8-188</i>	v5TE
000101	-	not 101x	-	Move to two ARM core registers from Coprocessor	<i>MRRC, MRRC2 on page A8-204</i>	v5TE
10xxxx	0	101x	-	-	<i>VFP data-processing instructions on page A7-24</i>	
		not 101x	-	Coprocessor data operations	<i>CDP, CDP2 on page A8-68</i>	All
	1	101x	-	Advanced SIMD, VFP	<i>8, 16, and 32-bit transfer between ARM core and extension registers on page A7-31</i>	
10xxx0	1	not 101x	-	Move to Coprocessor from ARM core register	<i>MCR, MCR2 on page A8-186</i>	All

Table A5-22 Supervisor Call, and coprocessor instructions (continued)

op1	op	coproc	Rn	Instructions	See	Variant
10xxx1	1	not 101x	-	Move to ARM core register from Coprocessor	<i>MRC</i> , <i>MRC2</i> on page A8-202	All
11xxxx	-	-	-	Supervisor Call	<i>SVC</i> (<i>previously SWI</i>) on page A8-430	All

a. But not 000x0x

For more information about specific coprocessors see *Coprocessor support* on page A2-68.

A5.7 Unconditional instructions

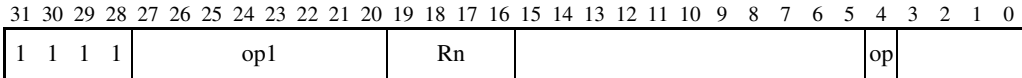

Table A5-23 shows the allocation of encodings in this space.

Other encodings in this space are UNDEFINED in ARMv5 and above.

All encodings in this space are UNPREDICTABLE in ARMv4 and ARMv4T.

Table A5-23 Unconditional instructions

op1	op	Rn	Instruction	See	Variant
0xxxxxxx	-	-	-	<i>Miscellaneous instructions, memory hints, and Advanced SIMD instructions</i> on page A5-31	
100xx1x0	-	-	Store Return State	<i>SRS</i> on page B6-20	v6
100xx0x1	-	-	Return From Exception	<i>RFE</i> on page B6-16	v6
101xxxxx	-	-	Branch with Link and Exchange	<i>BL, BLX (immediate)</i> on page A8-58	v5
11000x11	-	not 1111	Load Coprocessor (immediate)	<i>LDC, LDC2 (immediate)</i> on page A8-106	v5
11001xx1	-	1111	Load Coprocessor (literal)	<i>LDC, LDC2 (literal)</i> on page A8-108	v5
1101xxx1	-	1111			
11000x10 11001xx0 1101xxx0	-	-	Store Coprocessor	<i>STC, STC2</i> on page A8-372	v5
11000100	-	-	Move to Coprocessor from two ARM core registers	<i>MCRR, MCRR2</i> on page A8-188	v6
11000101	-	-	Move to two ARM core registers from Coprocessor	<i>MRRC, MRRC2</i> on page A8-204	v6
1110xxxx	0	-	Coprocessor data operations	<i>CDP, CDP2</i> on page A8-68	v5
1110xxx0	1	-	Move to Coprocessor from ARM core register	<i>MCR, MCR2</i> on page A8-186	v5
1110xxx1	1	-	Move to ARM core register from Coprocessor	<i>MRC, MRC2</i> on page A8-202	v5

A5.7.1 Miscellaneous instructions, memory hints, and Advanced SIMD instructions

31	30	29	28	27	26	25	24	23	22	21	20	19	18	17	16	15	14	13	12	11	10	9	8	7	6	5	4	3	2	1	0
1	1	1	1	0	op1						Rn				op2																

Table A5-24 shows the allocation of encodings in this space.

Other encodings in this space are UNDEFINED in ARMv5 and above. All these encodings are UNPREDICTABLE in ARMv4 and ARMv4T.

Table A5-24 Hints, and Advanced SIMD instructions

op1	op2	Rn	Instruction	See	Variant
0010000	xx0x	xxx0	Change Processor State	<i>CPS</i> on page B6-3	v6
0010000	0000	xxx1	Set Endianness	<i>SETEND</i> on page A8-314	v6
01xxxxx	-	-	See <i>Advanced SIMD data-processing instructions</i> on page A7-10		v7
100xxx0	-	-	See <i>Advanced SIMD element or structure load/store instructions</i> on page A7-27		v7
100x001	-	-	Unallocated memory hint (treat as NOP)		MP ^a Extensions
100x101	-	-	Preload Instruction	<i>PLI (immediate, literal)</i> on page A8-242	v7
101x001	-	not 1111	Preload Data with intent to Write	<i>PLD, PLDW (immediate)</i> on page A8-236	MP ^a Extensions
		1111	UNPREDICTABLE	-	-
101x101	-	not 1111	Preload Data	<i>PLD, PLDW (immediate)</i> on page A8-236	v5TE
		1111	Preload Data	<i>PLD (literal)</i> on page A8-238	v5TE
1010111	0001	-	Clear-Exclusive	<i>CLREX</i> on page A8-70	v6K
	0100	-	Data Synchronization Barrier	<i>DSB</i> on page A8-92	v6T2
	0101	-	Data Memory Barrier	<i>DMB</i> on page A8-90	v7
	0110	-	Instruction Synchronization Barrier	<i>ISB</i> on page A8-102	v6T2
10xxx11	-	-	UNPREDICTABLE except as shown above		-

Table A5-24 Hints, and Advanced SIMD instructions (continued)

op1	op2	Rn	Instruction	See	Variant
110x001	xxx0	-	Unallocated memory hint (treat as NOP)		MP ^a Extensions
110x101	xxx0	-	Preload Instruction	<i>PLI (register)</i> on page A8-244	v7
111x001	xxx0	-	Preload Data with intent to Write	<i>PLD, PLDW (register)</i> on page A8-240	MP ^a Extensions
111x101	xxx0	-	Preload Data	<i>PLD, PLDW (register)</i> on page A8-240	v5TE
11xxx11	xxx0	-	UNPREDICTABLE	-	-

a. Multiprocessing Extensions.

Chapter A6

Thumb Instruction Set Encoding

This chapter introduces the Thumb instruction set and describes how it uses the ARM programmers' model. It contains the following sections:

- *Thumb instruction set encoding* on page A6-2
- *16-bit Thumb instruction encoding* on page A6-6
- *32-bit Thumb instruction encoding* on page A6-14.

For details of the differences between the Thumb and ThumbEE instruction sets see Chapter A9 *ThumbEE*.

Note

- Architecture variant information in this chapter describes the architecture variant or extension in which the instruction encoding was introduced into the Thumb instruction set.
 - In the decode tables in this chapter, an entry of - for a field value means the value of the field does not affect the decoding.
-

A6.1 Thumb instruction set encoding

The Thumb instruction stream is a sequence of halfword-aligned halfwords. Each Thumb instruction is either a single 16-bit halfword in that stream, or a 32-bit instruction consisting of two consecutive halfwords in that stream.

If bits [15:11] of the halfword being decoded take any of the following values, the halfword is the first halfword of a 32-bit instruction:

- 0b11101
- 0b11110
- 0b11111.

Otherwise, the halfword is a 16-bit instruction.

For details of the encoding of 16-bit Thumb instructions see *16-bit Thumb instruction encoding* on page A6-6.

For details of the encoding of 32-bit Thumb instructions see *32-bit Thumb instruction encoding* on page A6-14.

A6.1.1 UNDEFINED and UNPREDICTABLE instruction set space

An attempt to execute an unallocated instruction results in either:

- Unpredictable behavior. The instruction is described as UNPREDICTABLE.
- An Undefined Instruction exception. The instruction is described as UNDEFINED.

An instruction is UNDEFINED if it is declared as UNDEFINED in an instruction description, or in this chapter.

An instruction is UNPREDICTABLE if:

- a bit marked (0) or (1) in the encoding diagram of an instruction is not 0 or 1 respectively, and the pseudocode for that encoding does not indicate that a different special case applies
- it is declared as UNPREDICTABLE in an instruction description or in this chapter.

Unless otherwise specified:

- Thumb instructions introduced in an architecture variant are either UNPREDICTABLE or UNDEFINED in earlier architecture variants.
- A Thumb instruction that is provided by one or more of the architecture extensions is either UNPREDICTABLE or UNDEFINED in an implementation that does not include any of those extensions.

In both cases, the instruction is UNPREDICTABLE if it is a 32-bit instruction in an architecture variant before ARMv6T2, and UNDEFINED otherwise.

A6.1.2 Use of 0b1111 as a register specifier

The use of 0b1111 as a register specifier is not normally permitted in Thumb instructions. When a value of 0b1111 is permitted, a variety of meanings is possible. For register reads, these meanings are:

- Read the PC value, that is, the address of the current instruction + 4. The base register of the table branch instructions TBB and TBH can be the PC. This enables branch tables to be placed in memory immediately after the instruction.

———— **Note** —————

Use of the PC as the base register in the STC instruction is deprecated in ARMv7.

- Read the word-aligned PC value, that is, the address of the current instruction + 4, with bits [1:0] forced to zero. The base register of LDC, LDR, LDRB, LDRD (pre-indexed, no writeback), LDRH, LDRSB, and LDRSH instructions can be the word-aligned PC. This enables PC-relative data addressing. In addition, some encodings of the ADD and SUB instructions permit their source registers to be 0b1111 for the same purpose.
- Read zero. This is done in some cases when one instruction is a special case of another, more general instruction, but with one operand zero. In these cases, the instructions are listed on separate pages, with a special case in the pseudocode for the more general instruction cross-referencing the other page.

For register writes, these meanings are:

- The PC can be specified as the destination register of an LDR instruction. This is done by encoding Rt as 0b1111. The loaded value is treated as an address, and the effect of execution is a branch to that address. bit [0] of the loaded value selects whether to execute ARM or Thumb instructions after the branch.

Some other instructions write the PC in similar ways, either implicitly (for example branch instructions) or by using a register mask rather than a register specifier (LDM). The address to branch to can be:

- a loaded value, for example, RFE
- a register value, for example, BX
- the result of a calculation, for example, TBB or TBH.

The method of choosing the instruction set used after the branch can be:

- similar to the LDR case, for LDM or BX
 - a fixed instruction set other than the one currently being used, for example, the immediate form of BLX
 - unchanged, for example branch instructions
 - set from the (J,T) bits of the SPSR, for RFE and SUBS PC,LR,#imm8.
- Discard the result of a calculation. This is done in some cases when one instruction is a special case of another, more general instruction, but with the result discarded. In these cases, the instructions are listed on separate pages, with a special case in the pseudocode for the more general instruction cross-referencing the other page.

- If the destination register specifier of an LDRB, LDRH, LDRSB, or LDRSH instruction is 0b1111, the instruction is a memory hint instead of a load operation.
- If the destination register specifier of an MRC instruction is 0b1111, bits [31:28] of the value transferred from the coprocessor are written to the N, Z, C, and V flags in the APSR, and bits [27:0] are discarded.

A6.1.3 Use of 0b1101 as a register specifier

R13 is defined in the Thumb instruction set so that its use is primarily as a stack pointer, and R13 is normally identified as SP in Thumb instructions. In 32-bit Thumb instructions, if you use R13 as a general-purpose register beyond the architecturally defined constraints described in this section, the results are UNPREDICTABLE.

The restrictions applicable to R13 are described in:

- *R13[1:0] definition*
- *32-bit Thumb instruction support for R13.*

See also *16-bit Thumb instruction support for R13* on page A6-5.

R13[1:0] definition

Bits [1:0] of R13 are SBZP. Writing a nonzero value to bits [1:0] causes UNPREDICTABLE behavior.

32-bit Thumb instruction support for R13

R13 instruction support is restricted to the following:

- R13 as the source or destination register of a MOV instruction. Only register to register transfers without shifts are supported, with no flag setting:

```
MOV    SP, <Rm>
MOV    <Rn>, SP
```
- Using the following instructions to adjust R13 up or down by a multiple of 4:

```
ADD{W} SP, SP, #<imm>
SUB{W} SP, SP, #<imm>
ADD    SP, SP, <Rm>
ADD    SP, SP, <Rm>, LSL #<n>      ; For <n> = 1, 2, 3
SUB    SP, SP, <Rm>
SUB    SP, SP, <Rm>, LSL #<n>      ; For <n> = 1, 2, 3
```
- R13 as a base register <Rn> of any load/store instruction. This supports SP-based addressing for load, store, or memory hint instructions, with positive or negative offsets, with and without writeback.
- R13 as the first operand <Rn> in any ADD{S}, CMN, CMP, or SUB{S} instruction. The add and subtract instructions support SP-based address generation, with the address going into a general-purpose register. CMN and CMP are useful for stack checking in some circumstances.
- R13 as the transferred register <Rt> in any LDR or STR instruction.

16-bit Thumb instruction support for R13

For 16-bit data-processing instructions that affect high registers, R13 can only be used as described in *32-bit Thumb instruction support for R13* on page A6-4. Any other use is deprecated. This affects the high register forms of CMP and ADD, where the use of R13 as $\langle Rn \rangle$ is deprecated.

A6.2 16-bit Thumb instruction encoding

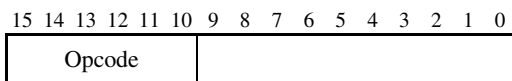

Table A6-1 shows the allocation of 16-bit instruction encodings.

Table A6-1 16-bit Thumb instruction encoding

Opcode	Instruction or instruction class	Variant
00xxxx	<i>Shift (immediate), add, subtract, move, and compare</i> on page A6-7	-
010000	<i>Data-processing</i> on page A6-8	-
010001	<i>Special data instructions and branch and exchange</i> on page A6-9	-
01001x	Load from Literal Pool, see <i>LDR (literal)</i> on page A8-122	v4T
0101xx	<i>Load/store single data item</i> on page A6-10	-
011xxx		
100xxx		
10100x	Generate PC-relative address, see <i>ADR</i> on page A8-32	v4T
10101x	Generate SP-relative address, see <i>ADD (SP plus immediate)</i> on page A8-28	v4T
1011xx	<i>Miscellaneous 16-bit instructions</i> on page A6-11	-
11000x	Store multiple registers, see <i>STM / STMIA / STMEA</i> on page A8-374 ^a	v4T
11001x	Load multiple registers, see <i>LDM / LDMIA / LDMFD</i> on page A8-110 ^a	v4T
1101xx	<i>Conditional branch, and Supervisor Call</i> on page A6-13	-
11100x	Unconditional Branch, see <i>B</i> on page A8-44	v4T

a. In ThumbEE, 16-bit load/store multiple instructions are not available. This encoding is used for special ThumbEE instructions. For details see Chapter A9 *ThumbEE*.

A6.2.1 Shift (immediate), add, subtract, move, and compare

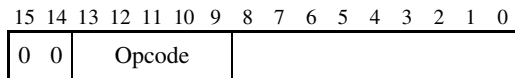

Table A6-2 shows the allocation of encodings in this space.

All these instructions are available since the Thumb instruction set was introduced in ARMv4T.

Table A6-2 16-bit Thumb shift (immediate), add, subtract, move, and compare instructions

Opcode	Instruction	See
000xx	Logical Shift Left	<i>LSL (immediate)</i> on page A8-178
001xx	Logical Shift Right	<i>LSR (immediate)</i> on page A8-182
010xx	Arithmetic Shift Right	<i>ASR (immediate)</i> on page A8-40
01100	Add register	<i>ADD (register)</i> on page A8-24
01101	Subtract register	<i>SUB (register)</i> on page A8-422
01110	Add 3-bit immediate	<i>ADD (immediate, Thumb)</i> on page A8-20
01111	Subtract 3-bit immediate	<i>SUB (immediate, Thumb)</i> on page A8-418
100xx	Move	<i>MOV (immediate)</i> on page A8-194
101xx	Compare	<i>CMP (immediate)</i> on page A8-80
110xx	Add 8-bit immediate	<i>ADD (immediate, Thumb)</i> on page A8-20
111xx	Subtract 8-bit immediate	<i>SUB (immediate, Thumb)</i> on page A8-418

A6.2.2 Data-processing

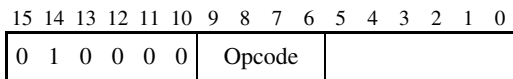

Table A6-3 shows the allocation of encodings in this space.

All these instructions are available since the Thumb instruction set was introduced in ARMv4T.

Table A6-3 16-bit Thumb data-processing instructions

Opcode	Instruction	See
0000	Bitwise AND	<i>AND (register)</i> on page A8-36
0001	Bitwise Exclusive OR	<i>EOR (register)</i> on page A8-96
0010	Logical Shift Left	<i>LSL (register)</i> on page A8-180
0011	Logical Shift Right	<i>LSR (register)</i> on page A8-184
0100	Arithmetic Shift Right	<i>ASR (register)</i> on page A8-42
0101	Add with Carry	<i>ADC (register)</i> on page A8-16
0110	Subtract with Carry	<i>SBC (register)</i> on page A8-304
0111	Rotate Right	<i>ROR (register)</i> on page A8-280
1000	Test	<i>TST (register)</i> on page A8-456
1001	Reverse Subtract from 0	<i>RSB (immediate)</i> on page A8-284
1010	Compare High Registers	<i>CMP (register)</i> on page A8-82
1011	Compare Negative	<i>CMN (register)</i> on page A8-76
1100	Bitwise OR	<i>ORR (register)</i> on page A8-230
1101	Multiply Two Registers	<i>MUL</i> on page A8-212
1110	Bitwise Bit Clear	<i>BIC (register)</i> on page A8-52
1111	Bitwise NOT	<i>MVN (register)</i> on page A8-216

A6.2.3 Special data instructions and branch and exchange

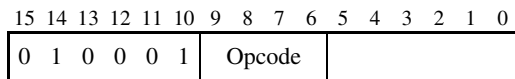

Table A6-4 shows the allocation of encodings in this space.

Table A6-4 16-bit Thumb special data instructions and branch and exchange

Opcode	Instruction	See	Variant
0000	Add Low Registers	<i>ADD (register)</i> on page A8-24	v6T2 ^a
0001 001x	Add High Registers	<i>ADD (register)</i> on page A8-24	v4T
0100	UNPREDICTABLE	-	-
0101 011x	Compare High Registers	<i>CMP (register)</i> on page A8-82	v4T
1000	Move Low Registers	<i>MOV (register)</i> on page A8-196	v6 ^a
1001 101x	Move High Registers	<i>MOV (register)</i> on page A8-196	v4T
110x	Branch and Exchange	<i>BX</i> on page A8-62	v4T
111x	Branch with Link and Exchange	<i>BLX (register)</i> on page A8-60	v5T ^a

a. UNPREDICTABLE in earlier variants.

A6.2.4 Load/store single data item

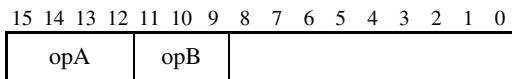

These instructions have one of the following values in opA:

- 0b0101
- 0b011x
- 0b100x.

Table A6-5 shows the allocation of encodings in this space.

All these instructions are available since the Thumb instruction set was introduced in ARMv4T.

Table A6-5 16-bit Thumb Load/store instructions

opA	opB	Instruction	See
0101	000	Store Register	<i>STR (register)</i> on page A8-386
	001	Store Register Halfword	<i>STRH (register)</i> on page A8-412
	010	Store Register Byte	<i>STRB (register)</i> on page A8-392
	011	Load Register Signed Byte	<i>LDRSB (register)</i> on page A8-164
	100	Load Register	<i>LDR (register)</i> on page A8-124
	101	Load Register Halfword	<i>LDRH (register)</i> on page A8-156
	110	Load Register Byte	<i>LDRB (register)</i> on page A8-132
	111	Load Register Signed Halfword	<i>LDRSH (register)</i> on page A8-172
0110	0xx	Store Register	<i>STR (immediate, Thumb)</i> on page A8-382
	1xx	Load Register	<i>LDR (immediate, Thumb)</i> on page A8-118
0111	0xx	Store Register Byte	<i>STRB (immediate, Thumb)</i> on page A8-388
	1xx	Load Register Byte	<i>LDRB (immediate, Thumb)</i> on page A8-126
1000	0xx	Store Register Halfword	<i>STRH (immediate, Thumb)</i> on page A8-408
	1xx	Load Register Halfword	<i>LDRH (immediate, Thumb)</i> on page A8-150
1001	0xx	Store Register SP relative	<i>STR (immediate, Thumb)</i> on page A8-382
	1xx	Load Register SP relative	<i>LDR (immediate, Thumb)</i> on page A8-118

A6.2.5 Miscellaneous 16-bit instructions

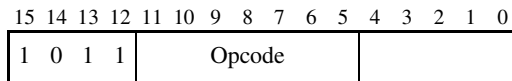

Table A6-6 shows the allocation of encodings in this space. Other encodings in this space are UNDEFINED.

Table A6-6 Miscellaneous 16-bit instructions

Opcode	Instruction	See	Variant
0110010	Set Endianness	<i>SETEND</i> on page A8-314	v6
0110011	Change Processor State	<i>CPS</i> on page B6-3	v6
00000xx	Add Immediate to SP	<i>ADD (SP plus immediate)</i> on page A8-28	v4T
00001xx	Subtract Immediate from SP	<i>SUB (SP minus immediate)</i> on page A8-426	v4T
0001xxx	Compare and Branch on Zero	<i>CBNZ, CBZ</i> on page A8-66	v6T2
001000x	Signed Extend Halfword	<i>SXTH</i> on page A8-444	v6
001001x	Signed Extend Byte	<i>SXTB</i> on page A8-440	v6
001010x	Unsigned Extend Halfword	<i>UXTH</i> on page A8-524	v6
001011x	Unsigned Extend Byte	<i>UXTB</i> on page A8-520	v6
0011xxx	Compare and Branch on Zero	<i>CBNZ, CBZ</i> on page A8-66	v6T2
010xxxx	Push Multiple Registers	<i>PUSH</i> on page A8-248	v4T
1001xxx	Compare and Branch on Nonzero	<i>CBNZ, CBZ</i> on page A8-66	v6T2
101000x	Byte-Reverse Word	<i>REV</i> on page A8-272	v6
101001x	Byte-Reverse Packed Halfword	<i>REV16</i> on page A8-274	v6
101011x	Byte-Reverse Signed Halfword	<i>REVSH</i> on page A8-276	v6
1011xxx	Compare and Branch on Nonzero	<i>CBNZ, CBZ</i> on page A8-66	v6T2
110xxxx	Pop Multiple Registers	<i>POP</i> on page A8-246	v4T
1110xxx	Breakpoint	<i>BKPT</i> on page A8-56	v5
1111xxx	If-Then, and hints	<i>If-Then, and hints</i> on page A6-12	-

If-Then, and hints

15	14	13	12	11	10	9	8	7	6	5	4	3	2	1	0
1	0	1	1	1	1	1	1	opA				opB			

Table A6-7 shows the allocation of encodings in this space.

Other encodings in this space are unallocated hints. They execute as NOPs, but software must not use them.

Table A6-7 Miscellaneous 16-bit instructions

opA	opB	Instruction	See	Variant
-	not 0000	If-Then	<i>IT</i> on page A8-104	v6T2
0000	0000	No Operation hint	<i>NOP</i> on page A8-222	v6T2
0001	0000	Yield hint	<i>YIELD</i> on page A8-812	v7
0010	0000	Wait For Event hint	<i>WFE</i> on page A8-808	v7
0011	0000	Wait For Interrupt hint	<i>WFI</i> on page A8-810	v7
0100	0000	Send Event hint	<i>SEV</i> on page A8-316	v7

A6.2.6 Conditional branch, and Supervisor Call

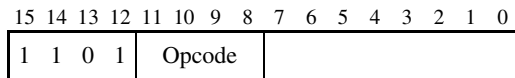

Table A6-8 shows the allocation of encodings in this space.

All these instructions are available since the Thumb instruction set was introduced in ARMv4T.

Table A6-8 Conditional branch and Supervisor Call instructions

Opcode	Instruction	See
not 111x	Conditional branch	<i>B</i> on page A8-44
1110	Permanently UNDEFINED. This space will not be allocated in future.	
1111	Supervisor Call	<i>SVC</i> (<i>previously SWI</i>) on page A8-430

A6.3 32-bit Thumb instruction encoding

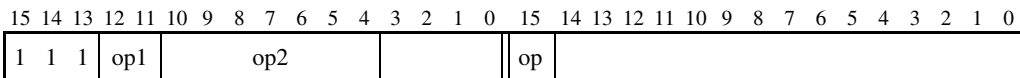

If op1 == 0b00, a 16-bit instruction is encoded, see *16-bit Thumb instruction encoding* on page A6-6.

Table A6-9 shows the allocation of encodings in this space.

Table A6-9 32-bit Thumb instruction encoding

op1	op2	op	Instruction class, see
01	00xx0xx	-	<i>Load/store multiple</i> on page A6-23
	00xx1xx	-	<i>Load/store dual, load/store exclusive, table branch</i> on page A6-24
	01xxxxx	-	<i>Data-processing (shifted register)</i> on page A6-31
	1xxxxxx	-	<i>Coprocessor instructions</i> on page A6-40
10	x0xxxxx	0	<i>Data-processing (modified immediate)</i> on page A6-15
	x1xxxxx	0	<i>Data-processing (plain binary immediate)</i> on page A6-19
	-	1	<i>Branches and miscellaneous control</i> on page A6-20
11	000xxx0	-	<i>Store single data item</i> on page A6-30
	001xxx0	-	<i>Advanced SIMD element or structure load/store instructions</i> on page A7-27
	00xx001	-	<i>Load byte, memory hints</i> on page A6-28
	00xx011	-	<i>Load halfword, memory hints</i> on page A6-26
	00xx101	-	<i>Load word</i> on page A6-25
	00xx111	-	UNDEFINED
	010xxxx	-	<i>Data-processing (register)</i> on page A6-33
	0110xxx	-	<i>Multiply, multiply accumulate, and absolute difference</i> on page A6-38
	0111xxx	-	<i>Long multiply, long multiply accumulate, and divide</i> on page A6-39
	1xxxxxx	-	<i>Coprocessor instructions</i> on page A6-40

A6.3.1 Data-processing (modified immediate)

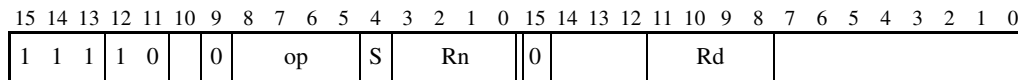

Table A6-10 shows the allocation of encodings in this space. Other encodings in this space are UNDEFINED.

~~In the Rn, Rd and S columns, indicates that the field value of the field does affect the decoding.~~



These encodings are all available in ARMv6T2 and above.

Table A6-10 32-bit modified immediate data-processing instructions

op	Rn	Rd	S	Instruction	See
0000	-	not 1111	x	Bitwise AND	<i>AND (immediate)</i> on page A8-34
		1111	0	UNPREDICTABLE	-
		1111	1	Test	<i>TST (immediate)</i> on page A8-454
0001	-	-	-	Bitwise Bit Clear	<i>BIC (immediate)</i> on page A8-50
0010	not 1111	-	-	Bitwise OR	<i>ORR (immediate)</i> on page A8-228
	1111	-	-	Move	<i>MOV (immediate)</i> on page A8-194
0011	not 1111	-	-	Bitwise OR NOT	<i>ORN (immediate)</i> on page A8-224
	1111	-	-	Bitwise NOT	<i>MVN (immediate)</i> on page A8-214
0100	-	not 1111	x	Bitwise Exclusive OR	<i>EOR (immediate)</i> on page A8-94
		1111	0	UNPREDICTABLE	-
			1	Test Equivalence	<i>TEQ (immediate)</i> on page A8-448
1000	-	not 1111	-	Add	<i>ADD (immediate, Thumb)</i> on page A8-20
		1111	0	UNPREDICTABLE	-
			1	Compare Negative	<i>CMN (immediate)</i> on page A8-74
1010	-	-	-	Add with Carry	<i>ADC (immediate)</i> on page A8-14
1011	-	-	-	Subtract with Carry	<i>SBC (immediate)</i> on page A8-302

Table A6-10 32-bit modified immediate data-processing instructions (continued)

op	Rn	Rd	S	Instruction	See
1101	-	not 1111	-	Subtract	<i>SUB (immediate, Thumb)</i> on page A8-418
		1111	0	UNPREDICTABLE	-
			1	Compare	<i>CMP (immediate)</i> on page A8-80
1110	-	-	-	Reverse Subtract	<i>RSB (immediate)</i> on page A8-284

These instructions all have modified immediate constants, rather than a simple 12-bit binary number. This provides a more useful range of values. For details see *Modified immediate constants in Thumb instructions* on page A6-17.

A6.3.2 Modified immediate constants in Thumb instructions

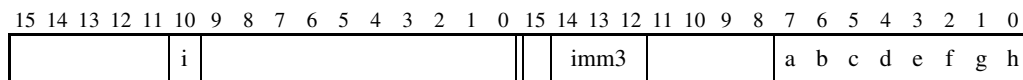

Table A6-11 shows the range of modified immediate constants available in Thumb data-processing instructions, and how they are encoded in the a, b, c, d, e, f, g, h, i, and imm3 fields in the instruction.

Table A6-11 Encoding of modified immediates in Thumb data-processing instructions

i:imm3:a	<const> ^a
0000x	00000000 00000000 00000000 abcdefgh
0001x	00000000 abcdefgh 00000000 abcdefgh ^b
0010x	abcdefgh 00000000 abcdefgh 00000000 ^b
0011x	abcdefgh abcdefgh abcdefgh abcdefgh ^b
01000	1bcdefgh 00000000 00000000 00000000
01001	01bcdefg h0000000 00000000 00000000 ^c
01010	001bcdef gh000000 00000000 00000000
01011	0001bcde fgh00000 00000000 00000000 ^c
.	.
.	. 8-bit values shifted to other positions
.	.
11101	00000000 00000000 000001bc defgh000 ^c
11110	00000000 00000000 0000001b cdefgh00
11111	00000000 00000000 00000001 bcdefgh0 ^c

- a. In this table, the immediate constant value is shown in binary form, to relate abcdefgh to the encoding diagram. In assembly syntax, the immediate value is specified in the usual way (a decimal number by default).
- b. Not available in ARM instructions. UNPREDICTABLE if abcdefgh == 00000000.
- c. Not available in ARM instructions if h == 1.

Note

The range of values available in Thumb modified immediate constants is slightly different from the range of values available in ARM instructions. See *Modified immediate constants in ARM instructions* on page A5-9 for the ARM values.

Carry out

A logical instruction with `i:imm3:a == '00xxx'` does not affect the carry flag. Otherwise, a logical instruction that sets the flags sets the Carry flag to the value of bit [31] of the modified immediate constant.

Operation

```
// ThumbExpandImm()
// =====

bits(32) ThumbExpandImm(bits(12) imm12)

    // APSR.C argument to following function call does not affect the imm32 result.
    (imm32, -) = ThumbExpandImm_C(imm12, APSR.C);

    return imm32;

// ThumbExpandImm_C()
// =====

(bits(32), bit) ThumbExpandImm_C(bits(12) imm12, bit carry_in)

    if imm12<11:10> == '00' then

        case imm12<9:8> of
            when '00'
                imm32 = ZeroExtend(imm12<7:0>, 32);
            when '01'
                if imm12<7:0> == '00000000' then UNPREDICTABLE;
                imm32 = '00000000' : imm12<7:0> : '00000000' : imm12<7:0>;
            when '10'
                if imm12<7:0> == '00000000' then UNPREDICTABLE;
                imm32 = imm12<7:0> : '00000000' : imm12<7:0> : '00000000';
            when '11'
                if imm12<7:0> == '00000000' then UNPREDICTABLE;
                imm32 = imm12<7:0> : imm12<7:0> : imm12<7:0> : imm12<7:0>;
            carry_out = carry_in;

    else

        unrotated_value = ZeroExtend('1':imm12<6:0>, 32);
        (imm32, carry_out) = ROR_C(unrotated_value, UInt(imm12<11:7>));

    return (imm32, carry_out);
```

A6.3.3 Data-processing (plain binary immediate)

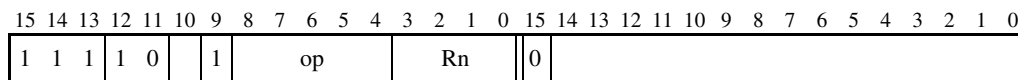

Table A6-12 shows the allocation of encodings in this space. Other encodings in this space are UNDEFINED.

These encodings are all available in ARMv6T2 and above.

Table A6-12 32-bit unmodified immediate data-processing instructions

op	Rn	Instruction	See
00000	not 1111	Add Wide (12-bit)	<i>ADD (immediate, Thumb)</i> on page A8-20
	1111	Form PC-relative Address	<i>ADR</i> on page A8-32
00100	-	Move Wide (16-bit)	<i>MOV (immediate)</i> on page A8-194
01010	not 1111	Subtract Wide (12-bit)	<i>SUB (immediate, Thumb)</i> on page A8-418
	1111	Form PC-relative Address	<i>ADR</i> on page A8-32
01100	-	Move Top (16-bit)	<i>MOVT</i> on page A8-200
100x0 a	-	Signed Saturate	<i>SSAT</i> on page A8-362
10010 ^b	-	Signed Saturate (two 16-bit)	<i>SSAT16</i> on page A8-364
10100	-	Signed Bit Field Extract	<i>SBFX</i> on page A8-308
10110	not 1111	Bit Field Insert	<i>BFI</i> on page A8-48
	1111	Bit Field Clear	<i>BFC</i> on page A8-46
110x0 a	-	Unsigned Saturate	<i>USAT</i> on page A8-504
11010 ^b	-	Unsigned Saturate 16	<i>USAT16</i> on page A8-506
11100	-	Unsigned Bit Field Extract	<i>UBFX</i> on page A8-466

- a. In the second halfword of the instruction, bits [14:12.7:6] != 0b000000.
 b. In the second halfword of the instruction, bits [14:12.7:6] == 0b000000.

A6.3.4 Branches and miscellaneous control

Table A6-13 shows the allocation of encodings in this space. Other encodings in this space are UNDEFINED.

Table A6-13 Branches and miscellaneous control instructions

op1	op	op2	Instruction	See	Variant
0x0	not x111xxx	-	Conditional branch	<i>B</i> on page A8-44	v6T2
	0111000	xx00	Move to Special Register, application level	<i>MSR (register)</i> on page A8-210	All
		xx01	Move to Special Register, system level	<i>MSR (register)</i> on page B6-14	All
		xx1x			
	0111001	-			
	0111010	-	-	<i>Change Processor State, and hints</i> on page A6-21	-
	0111011	-	-	<i>Miscellaneous control instructions</i> on page A6-21	-
	0111100	-	Branch and Exchange Jazelle	<i>BXJ</i> on page A8-64	v6T2
	0111101	-	Exception Return	<i>SUBS PC, LR and related instructions</i> on page B6-25	v6T2
	011111x	-	Move from Special Register	<i>MRS</i> on page A8-206	v6T2
000	1111111	-	Secure Monitor Call	<i>SMC (previously SMI)</i> on page B6-18	Security Extensions
010	1111111	-	Permanently UNDEFINED. This space will not be allocated in future.		
0x1	-	-	Branch	<i>B</i> on page A8-44	v6T2
1x0	-	-	Branch with Link and Exchange	<i>BL, BLX (immediate)</i> on page A8-58	v5T ^a
1x1	-	-	Branch with Link		v4T

a. UNDEFINED in ARMv4T.

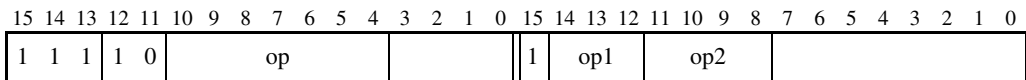
Change Processor State, and hints

15	14	13	12	11	10	9	8	7	6	5	4	3	2	1	0	15	14	13	12	11	10	9	8	7	6	5	4	3	2	1	0
1	1	1	1	0	0	1	1	1	0	1	0					1	0		0												

Table A6-14 shows the allocation of encodings in this space. Other encodings in this space are unallocated hints that execute as NOPs. These unallocated hint encodings are reserved and software must not use them.

Table A6-14 Change Processor State, and hint instructions

op1	op2	Instruction	See	Variant
not 000	-	Change Processor State	<i>CPS</i> on page B6-3	v6T2
000	00000000	No Operation hint	<i>NOP</i> on page A8-222	v6T2
	00000001	Yield hint	<i>YIELD</i> on page A8-812	v7
	00000010	Wait For Event hint	<i>WFE</i> on page A8-808	v7
	00000011	Wait For Interrupt hint	<i>WFI</i> on page A8-810	v7
	00000100	Send Event hint	<i>SEV</i> on page A8-316	v7
	1111xxxx	Debug hint	<i>DBG</i> on page A8-88	v7

Miscellaneous control instructions

15	14	13	12	11	10	9	8	7	6	5	4	3	2	1	0	15	14	13	12	11	10	9	8	7	6	5	4	3	2	1	0
1	1	1	1	0	0	1	1	1	0	1	1					1	0		0												

Table A6-15 shows the allocation of encodings in this space. Other encodings in this space are UNDEFINED in ARMv7. They are UNPREDICTABLE in ARMv6.

Table A6-15 Miscellaneous control instructions

op	Instruction	See	Variant
0000	Leave ThumbEE state ^a	<i>ENTERX</i> , <i>LEAVEX</i> on page A9-7	ThumbEE
0001	Enter ThumbEE state	<i>ENTERX</i> , <i>LEAVEX</i> on page A9-7	ThumbEE
0010	Clear-Exclusive	<i>CLREX</i> on page A8-70	v7

Table A6-15 Miscellaneous control instructions (continued)

op	Instruction	See	Variant
0100	Data Synchronization Barrier	<i>DSB</i> on page A8-92	v7
0101	Data Memory Barrier	<i>DMB</i> on page A8-90	v7
0110	Instruction Synchronization Barrier	<i>ISB</i> on page A8-102	v7

a. This instruction is a NOP in Thumb state.

A6.3.5 Load/store multiple

Table A6-16 shows the allocation of encodings in this space.

These encodings are all available in ARMv6T2 and above.

Table A6-16 Load/store multiple instructions

op	L	Rn	Instruction	See
00	0	-	Store Return State	<i>SRS</i> on page B6-20
	1	-	Return From Exception	<i>RFE</i> on page B6-16
01	0	-	Store Multiple (Increment After, Empty Ascending)	<i>STM / STMIA / STMEA</i> on page A8-374
	1	not 1101 ₁	Load Multiple (Increment After, Full Descending)	<i>LDM / LDMIA / LDMFD</i> on page A8-110
	1101 ₁	-	Pop Multiple Registers from the stack	<i>POP</i> on page A8-246
10	0	not 1101 ₁	Store Multiple (Decrement Before, Full Descending)	<i>STMDB / STMFD</i> on page A8-378
	1101 ₁	-	Push Multiple Registers to the stack.	<i>PUSH</i> on page A8-248
	1	-	Load Multiple (Decrement Before, Empty Ascending)	<i>LDMDB / LDMEA</i> on page A8-114
11	0	-	Store Return State	<i>SRS</i> on page B6-20
	1	-	Return From Exception	<i>RFE</i> on page B6-16

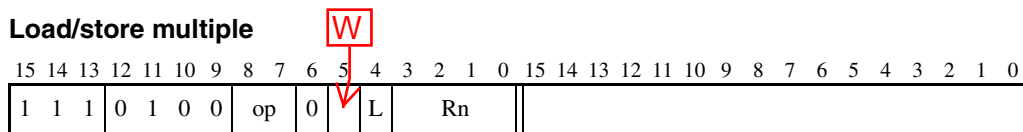
A6.3.6 Load/store dual, load/store exclusive, table branch

Table A6-17 shows the allocation of encodings in this space. Other encodings in this space are UNDEFINED.

Table A6-17 Load/store double or exclusive, table branch

op1	op2	op3	Rn	Instruction	See	Variant
00	00	-	-	Store Register Exclusive	<i>STREX</i> on page A8-400	v6T2
	01	-	-	Load Register Exclusive	<i>LDREX</i> on page A8-142	v6T2
0x 1x	10 x0	-	-	Store Register Dual	<i>STRD (immediate)</i> on page A8-396	v6T2
0x 1x	11 x1	-	not 1111 not 1111	Load Register Dual (immediate)	<i>LDRD (immediate)</i> on page A8-136	v6T2
0x 1x	11 x1	-	1111 1111	Load Register Dual (literal)	<i>LDRD (literal)</i> on page A8-138	v6T2
01	00	0100	-	Store Register Exclusive Byte	<i>STREXB</i> on page A8-402	v7
		0101	-	Store Register Exclusive Halfword	<i>STREXH</i> on page A8-406	v7
		0111	-	Store Register Exclusive Doubleword	<i>STREXD</i> on page A8-404	v7
01	00	0000	-	Table Branch Byte	<i>TBB, TBH</i> on page A8-446	v6T2
		0001	-	Table Branch Halfword	<i>TBB, TBH</i> on page A8-446	v6T2
		0100	-	Load Register Exclusive Byte	<i>LDREXB</i> on page A8-144	v7
		0101	-	Load Register Exclusive Halfword	<i>LDREXH</i> on page A8-148	v7
		0111	-	Load Register Exclusive Doubleword	<i>LDREXD</i> on page A8-146	v7

A6.3.7 Load word

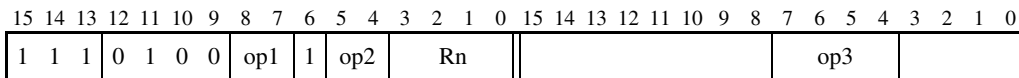
Table A6-18 shows the allocation of encodings in this space. Other encodings in this space are UNDEFINED. These encodings are all available in ARMv6T2 and above.

Table A6-18 Load word

op1	op2	Rn	Instruction	See
01	-	not 1111	Load Register	<i>LDR (immediate, Thumb)</i> on page A8-118
00	1xx1xx	not 1111		
	1100xx	not 1111		
	1110xx	not 1111	Load Register Unprivileged	<i>LDRT</i> on page A8-176
	000000	not 1111	Load Register	<i>LDR (register)</i> on page A8-124
0x	-	1111	Load Register	<i>LDR (literal)</i> on page A8-122

A6.3.8 Load halfword, memory hints

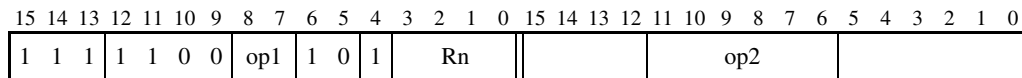
Table A6-19 shows the allocation of encodings in this space. Other encodings in this space are UNDEFINED.

Except where otherwise noted, these encodings are available in ARMv6T2 and above.

Table A6-19 Load halfword, preload

op1	op2	Rn	Rt	Instruction	See
0x	-	1111	not 1111	Load Register Halfword	<i>LDRH (literal)</i> on page A8-154
01	-	not 1111	not 1111	Load Register Halfword	<i>LDRH (immediate, Thumb)</i> on page A8-150
00	1xx1xx	not 1111	not 1111		
	1100xx	not 1111	not 1111		
	1110xx	not 1111	not 1111	Load Register Halfword Unprivileged	<i>LDRHT</i> on page A8-158
	000000	not 1111	not 1111	Load Register Halfword	<i>LDRH (register)</i> on page A8-156
1x	-	1111	not 1111	Load Register Signed Halfword	<i>LDRSH (literal)</i> on page A8-170
11	-	not 1111	not 1111	Load Register Signed Halfword	<i>LDRSH (immediate)</i> on page A8-168
10	1xx1xx	not 1111	not 1111		
	1100xx	not 1111	not 1111		
	1110xx	not 1111	not 1111	Load Register Signed Halfword Unprivileged	<i>LDRSHT</i> on page A8-174
	000000	not 1111	not 1111	Load Register Signed Halfword	<i>LDRSH (register)</i> on page A8-172
0x	-	1111	1111	UNPREDICTABLE	-
01	-	not 1111	1111	Preload Data with intent to Write ^a	<i>PLD, PLDW (immediate)</i> on page A8-236
00	1100xx	not 1111	1111	Preload Data with intent to Write ^a	<i>PLD, PLDW (immediate)</i> on page A8-236
	000000	not 1111	1111	Preload Data with intent to Write ^a	<i>PLD, PLDW (register)</i> on page A8-240

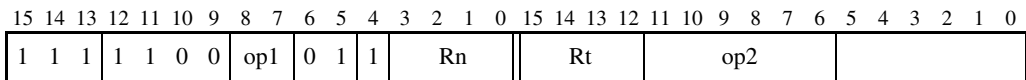
Table A6-19 Load halfword, preload (continued)

op1	op2	Rn	Rt	Instruction	See
00	1xx1xx	not 1111	1111	UNPREDICTABLE	-
	1110xx	not 1111	1111		
1x	-	1111	1111	Unallocated memory hint (treat as NOP)	
10	1100xx	not 1111	1111		
	000000	not 1111	1111		
10	1xx1xx	not 1111	1111	UNPREDICTABLE	-
	1110xx	not 1111	1111		
11	-	not 1111	1111	Unallocated memory hint (treat as NOP)	

- a. Available in ARMv7 with the Multiprocessing Extensions. In the ARMv7 base architecture and in ARMv6T2 these are unallocated memory hints (treat as NOP).

A6.3.9 Load byte, memory hints

Table A6-20 shows the allocation of encodings in this space. Other encodings in this space are UNDEFINED.

These encodings are all available in ARMv6T2 and above.

Table A6-20 Load byte, preload

op1	op2	Rn	Rt	Instruction	See
0x	-	1111	not 1111	Load Register Byte	<i>LDRB (literal)</i> on page A8-130
01	-	not 1111	not 1111	Load Register Byte	<i>LDRB (immediate, Thumb)</i> on page A8-126
00	1xx1xx	not 1111	not 1111		
	1100xx	not 1111	not 1111		
	1110xx	not 1111	not 1111	Load Register Byte Unprivileged	<i>LDRBT</i> on page A8-134
	000000	not 1111	not 1111	Load Register Byte	<i>LDRB (register)</i> on page A8-132
1x	-	1111	not 1111	Load Register Signed Byte	<i>LDRSB (literal)</i> on page A8-162
11	-	not 1111	not 1111	Load Register Signed Byte	<i>LDRSB (immediate)</i> on page A8-160
10	1xx1xx	not 1111	not 1111		
	1100xx	not 1111	not 1111		
	1110xx	not 1111	not 1111	Load Register Signed Byte Unprivileged	<i>LDRSBT</i> on page A8-166
	000000	not 1111	not 1111	Load Register Signed Byte	<i>LDRSB (register)</i> on page A8-164
0x	-	1111	1111	Preload Data	<i>PLD (literal)</i> on page A8-238
01	-	not 1111	1111	Preload Data	<i>PLD, PLDW (immediate)</i> on page A8-236
00	1100xx	not 1111	1111	Preload Data	<i>PLD, PLDW (immediate)</i> on page A8-236
	000000	not 1111	1111	Preload Data	<i>PLD, PLDW (register)</i> on page A8-240
	1xx1xx	not 1111	1111	UNPREDICTABLE	-
	1110xx	not 1111	1111		

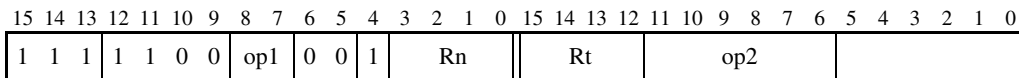
Table A6-20 Load byte, preload (continued)

op1	op2	Rn	Rt	Instruction	See
1x	-	1111	1111	Preload Instruction	<i>PLI (immediate, literal)</i> on page A8-242
11	-	not 1111	1111		
10	1100xx	not 1111	1111		
	000000	not 1111	1111	Preload Instruction	<i>PLI (register)</i> on page A8-244
	1xx1xx	not 1111	1111	UNPREDICTABLE	-
	1110xx	not 1111	1111		

A6.3.10 Store single data item

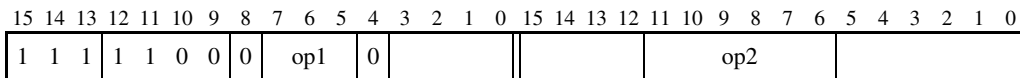





Table A6-21 show the allocation of encodings in this space. Other encodings in this space are UNDEFINED. These encodings are all available in ARMv6T2 and above.

Table A6-21 Store single data item

op1	op2	Instruction	See
100	-	Store Register Byte	<i>STRB (immediate, Thumb)</i> on page A8-388
000	1xx1xx		
	1100xx		
	1110xx	Store Register Byte Unprivileged	<i>STRBT</i> on page A8-394
	0xxxxx	Store Register Byte	<i>STRB (register)</i> on page A8-392 
101	-	Store Register Halfword	<i>STRH (immediate, Thumb)</i> on page A8-408
001	1xx1xx		
	1100xx		
	1110xx	Store Register Halfword Unprivileged	<i>STRHT</i> on page A8-414
001	0xxxxx	Store Register Halfword	<i>STRH (register)</i> on page A8-412 
110	-	Store Register (immediate)	<i>STR (immediate, Thumb)</i> on page A8-382
010	1xx1xx		
	1100xx		
	1110xx	Store Register Unprivileged	<i>STRT</i> on page A8-416
	0xxxxx	Store Register (register)	<i>STR (register)</i> on page A8-386 

A6.3.11 Data-processing (shifted register)

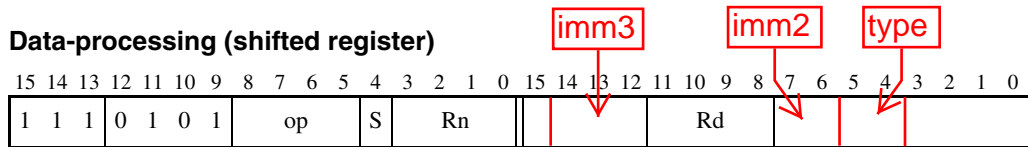

Table A6-22 shows the allocation of encodings in this space.

Other encodings in this space are UNDEFINED.

These encodings are all available in ARMv6T2 and above.

Table A6-22 Data-processing (shifted register)

op	Rn	Rd	S	Instruction	See
0000	-	not 1111	x	Bitwise AND	<i>AND (register)</i> on page A8-36
		1111	0	UNPREDICTABLE	-
			1	Test	<i>TST (register)</i> on page A8-456
0001	-	-	-	Bitwise Bit Clear	<i>BIC (register)</i> on page A8-52
0010	not 1111	-	-	Bitwise OR	<i>ORR (register)</i> on page A8-230
	1111	-	-	Move	<i>MOV (register)</i> on page A8-196
0011	not 1111	-	-	Bitwise OR NOT	<i>ORN (register)</i> on page A8-226
	1111	-	-	Bitwise NOT	<i>MVN (register)</i> on page A8-216
0100	-	not 1111	-	Bitwise Exclusive OR	<i>EOR (register)</i> on page A8-96
		1111	0	UNPREDICTABLE	-
			1	Test Equivalence	<i>TEQ (register)</i> on page A8-450
0110	-	-	-	Pack Halfword	<i>PKH</i> on page A8-234
1000	-	not 1111	-	Add	<i>ADD (register)</i> on page A8-24
		1111	0	UNPREDICTABLE	-
			1	Compare Negative	<i>CMN (register)</i> on page A8-76
1010	-	-	-	Add with Carry	<i>ADC (register)</i> on page A8-16
1011	-	-	-	Subtract with Carry	<i>SBC (register)</i> on page A8-304

Table A6-22 Data-processing (shifted register) (continued)

op	Rn	Rd	S	Instruction	See
1101	-	not 1111	-	Subtract	<i>SUB (register)</i> on page A8-422
		1111	0	UNPREDICTABLE	-
			1	Compare	<i>CMP (register)</i> on page A8-82
1110	-	-	-	Reverse Subtract	<i>RSB (register)</i> on page A8-286

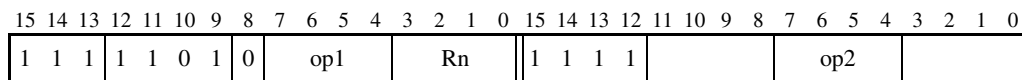
A6.3.12 Data-processing (register)

If, in the second halfword of the instruction, bits [15:12] != 0b1111, the instruction is UNDEFINED.

Table A6-23 shows the allocation of encodings in this space. Other encodings in this space are UNDEFINED.

These encodings are all available in ARMv6T2 and above.

Table A6-23 Data-processing (register)

op1	op2	Rn	Instruction	See
000x	0000	-	Logical Shift Left	<i>LSL (register)</i> on page A8-180
001x	0000	-	Logical Shift Right	<i>LSR (register)</i> on page A8-184
010x	0000	-	Arithmetic Shift Right	<i>ASR (register)</i> on page A8-42
011x	0000	-	Rotate Right	<i>ROR (register)</i> on page A8-280
0000	1xxx	not 1111	Signed Extend and Add Halfword	<i>SXTAH</i> on page A8-438
		1111	Signed Extend Halfword	<i>SXTH</i> on page A8-444
0001	1xxx	not 1111	Unsigned Extend and Add Halfword	<i>UXTAH</i> on page A8-518
		1111	Unsigned Extend Halfword	<i>UXTH</i> on page A8-524
0010	1xxx	not 1111	Signed Extend and Add Byte 16	<i>SXTAB16</i> on page A8-436
		1111	Signed Extend Byte 16	<i>SXTB16</i> on page A8-442
0011	1xxx	not 1111	Unsigned Extend and Add Byte 16	<i>UXTAB16</i> on page A8-516
		1111	Unsigned Extend Byte 16	<i>UXTB16</i> on page A8-522
0100	1xxx	not 1111	Signed Extend and Add Byte	<i>SXTAB</i> on page A8-434
		1111	Signed Extend Byte	<i>SXTB</i> on page A8-440
0101	1xxx	not 1111	Unsigned Extend and Add Byte	<i>UXTAB</i> on page A8-514
		1111	Unsigned Extend Byte	<i>UXTB</i> on page A8-520

Table A6-23 Data-processing (register) (continued)

op1	op2	Rn	Instruction	See
1xxx	00xx	-	-	<i>Parallel addition and subtraction, signed on page A6-35</i>
	01xx	-	-	<i>Parallel addition and subtraction, unsigned on page A6-36</i>
10xx	10xx	-	-	<i>Miscellaneous operations on page A6-37</i>

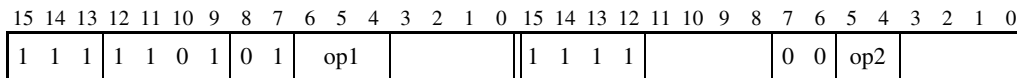
A6.3.13 Parallel addition and subtraction, signed

If, in the second halfword of the instruction, bits [15:12] != 0b1111, the instruction is UNDEFINED.

Table A6-24 shows the allocation of encodings in this space. Other encodings in this space are UNDEFINED. These encodings are all available in ARMv6T2 and above.

Table A6-24 Signed parallel addition and subtraction instructions

op1	op2	Instruction	See
001	00	Add 16-bit	<i>SADD16</i> on page A8-296
010	00	Add, Subtract	<i>SASX</i> on page A8-300
110	00	Subtract, Add	<i>SSAX</i> on page A8-366
101	00	Subtract 16-bit	<i>SSUB16</i> on page A8-368
000	00	Add 8-bit	<i>SADD8</i> on page A8-298
100	00	Subtract 8-bit	<i>SSUB8</i> on page A8-370
Saturating instructions			
001	01	Saturating Add 16-bit	<i>QADD16</i> on page A8-252
010	01	Saturating Add, Subtract	<i>QASX</i> on page A8-256
110	01	Saturating Subtract, Add	<i>QSAX</i> on page A8-262
101	01	Saturating Subtract 16-bit	<i>QSUB16</i> on page A8-266
000	01	Saturating Add 8-bit	<i>QADD8</i> on page A8-254
100	01	Saturating Subtract 8-bit	<i>QSUB8</i> on page A8-268
Halving instructions			
001	10	Halving Add 16-bit	<i>SHADD16</i> on page A8-318
010	10	Halving Add, Subtract	<i>SHASX</i> on page A8-322
110	10	Halving Subtract, Add	<i>SHSAX</i> on page A8-324
101	10	Halving Subtract 16-bit	<i>SHSUB16</i> on page A8-326
000	10	Halving Add 8-bit	<i>SHADD8</i> on page A8-320
100	10	Halving Subtract 8-bit	<i>SHSUB8</i> on page A8-328

A6.3.14 Parallel addition and subtraction, unsigned

15	14	13	12	11	10	9	8	7	6	5	4	3	2	1	0	15	14	13	12	11	10	9	8	7	6	5	4	3	2	1	0
1	1	1	1	1	0	1	0	1	op1						1	1	1	1	0	1	op2										

If, in the second halfword of the instruction, bits [15:12] != 0b1111, the instruction is UNDEFINED.

Table A6-25 shows the allocation of encodings in this space. Other encodings in this space are UNDEFINED. These encodings are all available in ARMv6T2 and above.

Table A6-25 Unsigned parallel addition and subtraction instructions

op1	op2	Instruction	See
001	00	Add 16-bit	<i>UADD16</i> on page A8-460
010	00	Add, Subtract	<i>UASX</i> on page A8-464
110	00	Subtract, Add	<i>USAX</i> on page A8-508
101	00	Subtract 16-bit	<i>USUB16</i> on page A8-510
000	00	Add 8-bit	<i>UADD8</i> on page A8-462
100	00	Subtract 8-bit	<i>USUB8</i> on page A8-512
Saturating instructions			
001	01	Saturating Add 16-bit	<i>UQADD16</i> on page A8-488
010	01	Saturating Add, Subtract	<i>UQASX</i> on page A8-492
110	01	Saturating Subtract, Add	<i>UQSAX</i> on page A8-494
101	01	Saturating Subtract 16-bit	<i>UQSUB16</i> on page A8-496
000	01	Saturating Add 8-bit	<i>UQADD8</i> on page A8-490
100	01	Saturating Subtract 8-bit	<i>UQSUB8</i> on page A8-498
Halving instructions			
001	10	Halving Add 16-bit	<i>UHADD16</i> on page A8-470
010	10	Halving Add, Subtract	<i>UHASX</i> on page A8-474
110	10	Halving Subtract, Add	<i>UHSAX</i> on page A8-476
101	10	Halving Subtract 16-bit	<i>UHSUB16</i> on page A8-478
000	10	Halving Add 8-bit	<i>UHADD8</i> on page A8-472
100	10	Halving Subtract 8-bit	<i>UHSUB8</i> on page A8-480

A6.3.15 Miscellaneous operations

15	14	13	12	11	10	9	8	7	6	5	4	3	2	1	0	15	14	13	12	11	10	9	8	7	6	5	4	3	2	1	0														
1	1	1	1	1	0	1	0	1	0	op1						1	1	1	1	1											1	0	op2												

If, in the second halfword of the instruction, bits [15:12] != 0b1111, the instruction is UNDEFINED.

Table A6-26 shows the allocation of encodings in this space. Other encodings in this space are UNDEFINED. These encodings are all available in ARMv6T2 and above.

Table A6-26 Miscellaneous operations

op1	op2	Instruction	See
00	00	Saturating Add	<i>QADD</i> on page A8-250
	01	Saturating Double and Add	<i>QDADD</i> on page A8-258
	10	Saturating Subtract	<i>QSUB</i> on page A8-264
	11	Saturating Double and Subtract	<i>QDSUB</i> on page A8-260
01	00	Byte-Reverse Word	<i>REV</i> on page A8-272
	01	Byte-Reverse Packed Halfword	<i>REV16</i> on page A8-274
	10	Reverse Bits	<i>RBIT</i> on page A8-270
	11	Byte-Reverse Signed Halfword	<i>REVSH</i> on page A8-276
10	00	Select Bytes	<i>SEL</i> on page A8-312
11	00	Count Leading Zeros	<i>CLZ</i> on page A8-72

A6.3.16 Multiply, multiply accumulate, and absolute difference

15	14	13	12	11	10	9	8	7	6	5	4	3	2	1	0	15	14	13	12	11	10	9	8	7	6	5	4	3	2	1	0
1	1	1	1	1	0	1	1	0	op1				Ra				0 0		op2												

If, in the second halfword of the instruction, bits [7:6] != 0b00, the instruction is UNDEFINED.

Table A6-27 shows the allocation of encodings in this space. Other encodings in this space are UNDEFINED. These encodings are all available in ARMv6T2 and above.

Table A6-27 Multiply, multiply accumulate, and absolute difference operations

op1	op2	Ra	Instruction	See
000	00	not 1111	Multiply Accumulate	<i>MLA</i> on page A8-190
		1111	Multiply	<i>MUL</i> on page A8-212
	01	-	Multiply and Subtract	<i>MLS</i> on page A8-192
001	-	not 1111	Signed Multiply Accumulate (Halfwords)	<i>SMLABB</i> , <i>SMLABT</i> , <i>SMLATB</i> , <i>SMLATT</i> on page A8-330
		1111	Signed Multiply (Halfwords)	<i>SMULBB</i> , <i>SMULBT</i> , <i>SMULTB</i> , <i>SMULTT</i> on page A8-354
010	0x	not 1111	Signed Multiply Accumulate Dual	<i>SMLAD</i> on page A8-332
		1111	Signed Dual Multiply Add	<i>SMUAD</i> on page A8-352
011	0x	not 1111	Signed Multiply Accumulate (Word by halfword)	<i>SMLAWB</i> , <i>SMLAWT</i> on page A8-340
		1111	Signed Multiply (Word by halfword)	<i>SMULWB</i> , <i>SMULWT</i> on page A8-358
100	0x	not 1111	Signed Multiply Subtract Dual	<i>SMLSD</i> on page A8-342
		1111	Signed Dual Multiply Subtract	<i>SMUSD</i> on page A8-360
101	0x	not 1111	Signed Most Significant Word Multiply Accumulate	<i>SMMLA</i> on page A8-346
		1111	Signed Most Significant Word Multiply	<i>SMMUL</i> on page A8-350
110	0x	-	Signed Most Significant Word Multiply Subtract	<i>SMMLS</i> on page A8-348
111	00	not 1111	Unsigned Sum of Absolute Differences	<i>USAD8</i> on page A8-500
		1111	Unsigned Sum of Absolute Differences, Accumulate	<i>USADA8</i> on page A8-502

A6.3.17 Long multiply, long multiply accumulate, and divide

Table A6-28 shows the allocation of encodings in this space. Other encodings in this space are UNDEFINED.

Table A6-28 Multiply, multiply accumulate, and absolute difference operations

op1	op2	Instruction	See	Variant
000	0000	Signed Multiply Long	<i>SMULL</i> on page A8-356	v6T2
001	1111	Signed Divide	<i>SDIV</i> on page A8-310	v7-R ^a
010	0000	Unsigned Multiply Long	<i>UMULL</i> on page A8-486	v6T2
011	1111	Unsigned Divide	<i>UDIV</i> on page A8-468	v7-R ^a
100	0000	Signed Multiply Accumulate Long	<i>SMLAL</i> on page A8-334	v6T2
	10xx	Signed Multiply Accumulate Long (Halfwords)	<i>SMLALBB</i> , <i>SMLALBT</i> , <i>SMLALTB</i> , <i>SMLALTT</i> on page A8-336	v6T2
	110x	Signed Multiply Accumulate Long Dual	<i>SMLALD</i> on page A8-338	v6T2
101	110x	Signed Multiply Subtract Long Dual	<i>SMLSLLD</i> on page A8-344	v6T2
110	0000	Unsigned Multiply Accumulate Long	<i>UMLAL</i> on page A8-484	v6T2
	0110	Unsigned Multiply Accumulate Accumulate Long	<i>UMAAL</i> on page A8-482	v6T2

a. UNDEFINED in ARMv7-A.

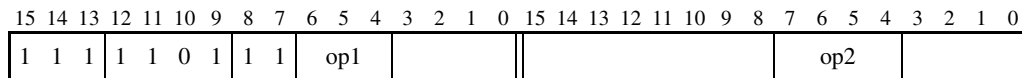
A6.3.18 Coprocessor instructions

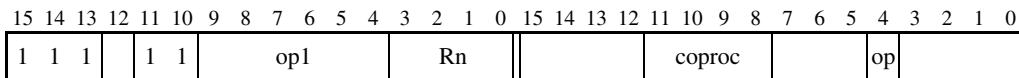

Table A6-29 shows the allocation of encodings in this space. These encodings are all available in ARMv6T2 and above.

Table A6-29 Coprocessor instructions

op1	op	coproc	Rn	Instructions	See
000x1x 001xxx 01xxxx	-	101x	-	Advanced SIMD, VFP	<i>Extension register load/store instructions on page A7-26</i>
000x10 001xx0 01xxx0	-	not 101x	-	Store Coprocessor	<i>STC, STC2 on page A8-372</i>
000x11 001xx1 01xxx1	-	not 101x	not 1111	Load Coprocessor (immediate)	<i>LDC, LDC2 (immediate) on page A8-106</i>
000x11 001xx1 01xxx1	-	not 101x	1111	Load Coprocessor (literal)	<i>LDC, LDC2 (literal) on page A8-108</i>
00000x	-	-	-	UNDEFINED	-
00010x	-	101x	-	Advanced SIMD, VFP	<i>64-bit transfers between ARM core and extension registers on page A7-32</i>
000100	-	not 101x	-	Move to Coprocessor from two ARM core registers	<i>MCRR, MCRR2 on page A8-188</i>
000101	-	not 101x	-	Move to two ARM core registers from Coprocessor	<i>MRRC, MRRC2 on page A8-204</i>
10xxxx	0	101x	-	VFP	<i>VFP data-processing instructions on page A7-24</i>
		not 101x	-	Coprocessor data operations	<i>CDP, CDP2 on page A8-68</i>

Table A6-29 Coprocessor instructions (continued)

op1	op	coproc	Rn	Instructions	See
10xxxx	1	101x	-	Advanced SIMD, VFP	<i>8, 16, and 32-bit transfer between ARM core and extension registers on page A7-31</i>
10xxx0	1	not 101x	-	Move to Coprocessor from ARM core register	<i>MCR, MCR2 on page A8-186</i>
10xxx1	1	not 101x	-	Move to ARM core register from Coprocessor	<i>MRC, MRC2 on page A8-202</i>
11xxxx	-	-	-	Advanced SIMD	<i>Advanced SIMD data-processing instructions on page A7-10</i>

For more information about specific coprocessors see *Coprocessor support* on page A2-68.

Chapter A7

Advanced SIMD and VFP

Instruction Encoding

This chapter gives an overview of the Advanced SIMD and VFP instruction sets. It contains the following sections:

- *Overview* on page A7-2
- *Advanced SIMD and VFP instruction syntax* on page A7-3
- *Register encoding* on page A7-8
- *Advanced SIMD data-processing instructions* on page A7-10
- *VFP data-processing instructions* on page A7-24
- *Extension register load/store instructions* on page A7-26
- *Advanced SIMD element or structure load/store instructions* on page A7-27
- *8, 16, and 32-bit transfer between ARM core and extension registers* on page A7-31
- *64-bit transfers between ARM core and extension registers* on page A7-32.

Note

- The Advanced SIMD architecture extension, its associated implementations, and supporting software, are commonly referred to as NEON™ technology.
 - In the decode tables in this chapter, an entry of - for a field value means the value of the field does not affect the decoding.
-

A7.1 Overview

All Advanced SIMD and VFP instructions are available in both ARM state and Thumb state.

A7.1.1 Advanced SIMD

The following sections describe the classes of instruction in the Advanced SIMD extension:

- *Advanced SIMD data-processing instructions* on page A7-10
- *Advanced SIMD element or structure load/store instructions* on page A7-27
- *Extension register load/store instructions* on page A7-26
- *8, 16, and 32-bit transfer between ARM core and extension registers* on page A7-31
- *64-bit transfers between ARM core and extension registers* on page A7-32.

A7.1.2 VFP

The following sections describe the classes of instruction in the VFP extension:

- *Extension register load/store instructions* on page A7-26
- *8, 16, and 32-bit transfer between ARM core and extension registers* on page A7-31
- *64-bit transfers between ARM core and extension registers* on page A7-32
- *VFP data-processing instructions* on page A7-24.

A7.2 Advanced SIMD and VFP instruction syntax

Advanced SIMD and VFP instructions use the general conventions of the ARM instruction set.

Advanced SIMD and VFP data-processing instructions use the following general format:

```
V{<modifier>}<operation>{<shape>}<c><q>{.<dt>} {<dest>}, {<src1>, <src2>}
```

All Advanced SIMD and VFP instructions begin with a V. This distinguishes Advanced SIMD vector and VFP instructions from ARM scalar instructions.

The main operation is specified in the <operation> field. It is usually a three letter mnemonic the same as or similar to the corresponding scalar integer instruction.

The <c> and <q> fields are standard assembler syntax fields. For details see *Standard assembler syntax fields* on page A8-7.

A7.2.1 Advanced SIMD Instruction modifiers

The <modifier> field provides additional variants of some instructions. Table A7-1 provides definitions of the modifiers. Modifiers are not available for every instruction.

Table A7-1 Advanced SIMD instruction modifiers

<modifier>	Meaning
Q	The operation uses saturating arithmetic.
R	The operation performs rounding.
D	The operation doubles the result (before accumulation, if any).
H	The operation halves the result.

A7.2.2 Advanced SIMD Operand shapes

The <shape> field provides additional variants of some instructions. Table A7-2 provides definitions of the shapes. Operand shapes are not available for every instruction.

Table A7-2 Advanced SIMD operand shapes

<shape>	Meaning	Typical register shape
(none)	The operands and result are all the same width.	Dd, Dn, Dm Qd, Qn, Qm
L	Long operation - result is twice the width of both operands	Qd, Dn, Dm
N	Narrow operation - result is half the width of both operands	Dd, Qn, Qm
W	Wide operation - result and first operand are twice the width of the second operand	Qd, Qn, Dm

A7.2.3 Data type specifiers

The <dt> field normally contains one data type specifier. This indicates the data type contained in

- the second operand, if any
- the operand, if there is no second operand
- the result, if there are no operand registers.

The data types of the other operand and result are implied by the <dt> field combined with the instruction shape. For information about data type formats see *Data types supported by the Advanced SIMD extension* on page A2-25.

In the instruction syntax descriptions in Chapter A8 *Instruction Details*, the <dt> field is usually specified as a single field. However, where more convenient, it is sometimes specified as a concatenation of two fields, <type><size>.

Syntax flexibility

There is some flexibility in the data type specifier syntax:

- You can specify three data types, specifying the result and both operand data types. For example:
`VSUBW.I16.I16.S8 Q3,Q5,D0`
 instead of:
`VSUBW.S8 Q3,Q5,D0`
- You can specify two data types, specifying the data types of the two operands. The data type of the result is implied by the instruction shape.
- You can specify two data types, specifying the data types of the single operand and the result.
- Where an instruction requires a less specific data type, you can instead specify a more specific type, as shown in Table A7-3.
- Where an instruction does not require a data type, you can provide one.
- The F32 data type can be abbreviated to F.
- The F64 data type can be abbreviated to D.

In all cases, if you provide additional information, the additional information must match the instruction shape. Disassembly does not regenerate this additional information.

Table A7-3 Data type specification flexibility

Specified data type	Permitted more specific data types				
None	Any				
.I<size>	-	.S<size>	.U<size>	-	-
.8	.I8	.S8	.U8	.P8	-
.16	.I16	.S16	.U16	.P16	.F16
.32	.I32	.S32	.U32	-	.F32 or .F
.64	.I64	.S64	.U64	-	.F64 or .D

A7.2.4 Register specifiers

The <dest>, <src1>, and <src2> fields contain register specifiers, or in some cases scalar specifiers or register lists. Table A7-4 shows the register and scalar specifier formats that appear in the instruction descriptions.

If <dest> is omitted, it is the same as <src1>.

Table A7-4 Advanced SIMD and VFP register specifier formats

<specifier>	Usual meaning ^a
<Qd>	A quadword destination register for the result vector (Advanced SIMD only).
<Qn>	A quadword source register for the first operand vector (Advanced SIMD only).
<Qm>	A quadword source register for the second operand vector (Advanced SIMD only).
<Dd>	A doubleword destination register for the result vector.
<Dn>	A doubleword source register for the first operand vector.
<Dm>	A doubleword source register for the second operand vector.
<Sd>	A singleword destination register for the result vector (VFP only).
<Sn>	A singleword source register for the first operand vector (VFP only).
<Sm>	A singleword source register for the second operand vector (VFP only).
<Dd[x]>	A destination scalar for the result. Element x of vector <Dd>. (Advanced SIMD only).
<Dn[x]>	A source scalar for the first operand. Element x of vector <Dn>. (Advanced SIMD only).
<Dm[x]>	A source scalar for the second operand. Element x of vector <Dm>. (Advanced SIMD only).
<Rd>	An ARM core register. Can be source or destination.
<Rm>	An ARM core register. Can be source or destination.

a. In some instructions the roles of registers are different.

A7.2.5 Register lists

A register list is a list of register specifiers separated by commas and enclosed in brackets { and }. There are restrictions on what registers can appear in a register list. These restrictions are described in the individual instruction descriptions. Table A7-5 shows some register list formats, with examples of actual register lists corresponding to those formats.

Note

Register lists must not wrap around the end of the register bank.

Syntax flexibility

There is some flexibility in the register list syntax:

- Where a register list contains consecutive registers, they can be specified as a range, instead of listing every register, for example {D0-D3} instead of {D0,D1,D2,D3}.
- Where a register list contains an even number of consecutive doubleword registers starting with an even numbered register, it can be written as a list of quadword registers instead, for example {Q1,Q2} instead of {D2-D5}.
- Where a register list contains only one register, the enclosing braces can be omitted, for example VLD1.8 D0,[R0] instead of VLD1.8 {D0},[R0].

Table A7-5 Example register lists

Format	Example	Alternative
{<Dd>}	{D3}	D3
{<Dd>,<Dd+1>,<Dd+2>}	{D3,D4,D5}	{D3-D5}
{<Dd[x]>,<Dd+2[x]>}	{D0[3],D2[3]}	-
{<Dd[]>}	{D7[]}	D7[]

A7.3 Register encoding

Advanced SIMD registers are either *quadword* (128 bits wide) or *doubleword* (64 bits wide). Some instructions have options for either doubleword or quadword registers. This is normally encoded in Q (bit [6]) as Q = 0 for doubleword operations, Q = 1 for quadword operations.

VFP registers are either double-precision (64 bits wide) or single-precision (32 bits wide). This is encoded in the sz field (bit [8]) as sz = 1 for double-precision operations, or sz = 0 for single-precision operations.

Some instructions use only one or two registers, and use the unused register fields as additional opcode bits.

Table A7-6 shows the encodings for the registers.

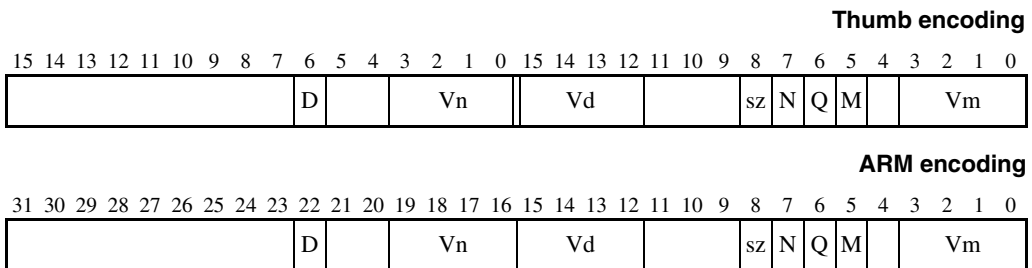

Table A7-6 Encoding of register numbers

Register mnemonic	Usual usage	Register number encoded in	Notes ^a	Used in
<Qd>	Destination (quadword)	D, Vd (bits [22,15:13])	bit [12] == 0	Adv. SIMD
<Qn>	First operand (quadword)	N, Vn (bits [7,19:17])	bit [16] == 0	Adv. SIMD
<Qm>	Second operand (quadword)	M, Vm (bits [5,3:1])	bit [0] == 0	Adv. SIMD
<Dd>	Destination (doubleword)	D, Vd (bits [22,15:12])	-	Both
<Dn>	First operand (doubleword)	N, Vn (bits [7,19:16])	-	Both
<Dm>	Second operand (doubleword)	M, Vm (bits [5,3:0])	-	Both
<Sd>	Destination (single-precision)	Vd, D (bits [15:12,22])	-	VFP
<Sn>	First operand (single-precision)	Vn, N (bits [19:16,7])	-	VFP
<Sm>	Second operand (single-precision)	Vm, M (bits [3:0,5])	-	VFP

a. If one of these bits is 1, the instruction is UNDEFINED.

A7.3.1 Advanced SIMD scalars

Advanced SIMD scalars can be 8-bit, 16-bit, 32-bit, or 64-bit. Instructions other than multiply instructions can access any element in the register set. The instruction syntax refers to the scalars using an index into a doubleword vector. The descriptions of the individual instructions contain details of the encodings.

Table A7-7 shows the form of encoding for scalars used in multiply instructions. These instructions cannot access scalars in some registers. The descriptions of the individual instructions contain cross references to this section where appropriate.

32-bit Advanced SIMD scalars, when used as single-precision floating-point numbers, are equivalent to VFP single-precision registers. That is, $D_m[x]$ in a 32-bit context ($0 \leq m \leq 15$, $0 \leq x \leq 1$) is equivalent to $S[2m + x]$.

Table A7-7 Encoding of scalars in multiply instructions

Scalar mnemonic	Usual usage	Scalar size	Register specifier	Index specifier	Accessible registers
<D _m [x]>	Second operand	16-bit	V _m [2:0]	M, V _m [3]	D0-D7
		32-bit	V _m [3:0]	M	D0-D15

A7.4 Advanced SIMD data-processing instructions

Thumb encoding

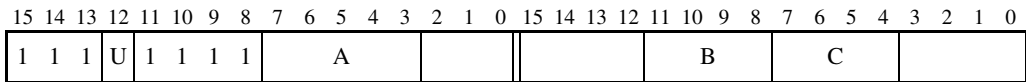

ARM encoding

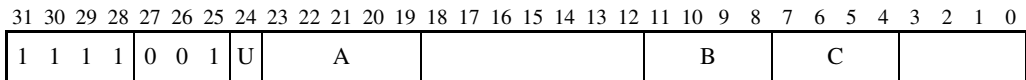

Table A7-8 shows the encoding for Advanced SIMD data-processing instructions. Other encodings in this space are UNDEFINED.

In these instructions, the U bit is in a different location in ARM and Thumb instructions. This is bit [12] of the first halfword in the Thumb encoding, and bit [24] in the ARM encoding. Other variable bits are in identical locations in the two encodings, after adjusting for the fact that the ARM encoding is held in memory as a single word and the Thumb encoding is held as two consecutive halfwords.

The ARM instructions can only be executed unconditionally. The Thumb instructions can be executed conditionally by using the IT instruction. For details see *IT* on page A8-104.

Table A7-8 Data-processing instructions

U	A	B	C	See
-	0xxxx	-	-	<i>Three registers of the same length on page A7-12</i>
	1x000	-	0xx1	<i>One register and a modified immediate value on page A7-21</i>
	1x001	-	0xx1	<i>Two registers and a shift amount on page A7-17</i>
	1x01x	-	0xx1	
	1x1xx	-	0xx1	
	1xxxx	-	1xx1	
	1x0xx	-	x0x0	<i>Three registers of different lengths on page A7-15</i>
	1x10x	-	x0x0	
	1x0xx	-	x1x0	<i>Two registers and a scalar on page A7-16</i>
	1x10x	-	x1x0	

Table A7-8 Data-processing instructions (continued)

U	A	B	C	See
0	1x11x	-	xxx0	Vector Extract, <i>VEXT</i> on page A8-598
1	1x11x	0xxx	xxx0	<i>Two registers, miscellaneous</i> on page A7-19
		10xx	xxx0	Vector Table Lookup, <i>VTBL</i> , <i>VTBX</i> on page A8-798
		1100	0xx0	Vector Duplicate, <i>VDUP (scalar)</i> on page A8-592

A7.4.1 Three registers of the same length

Thumb encoding

15	14	13	12	11	10	9	8	7	6	5	4	3	2	1	0	15	14	13	12	11	10	9	8	7	6	5	4	3	2	1	0
1	1	1	U	1	1	1	1	0		C												A			B						

ARM encoding

31	30	29	28	27	26	25	24	23	22	21	20	19	18	17	16	15	14	13	12	11	10	9	8	7	6	5	4	3	2	1	0
1	1	1	1	0	0	1	U	0		C													A				B				

Table A7-9 shows the allocation of encodings in this space. Other encodings in this space are UNDEFINED.

Table A7-9 Three registers of the same length

A	B	U	C	Instruction	See
0000	0	-	-	Vector Halving Add	<i>VHADD</i> , <i>VHSUB</i> on page A8-600
	1	-	-	Vector Saturating Add	<i>VQADD</i> on page A8-700
0001	0	-	-	Vector Rounding Halving Add	<i>VRHADD</i> on page A8-734
	1	0	00	Vector Bitwise AND	<i>VAND</i> (<i>register</i>) on page A8-544
			01	Vector Bitwise Bit Clear (AND complement)	<i>VBIC</i> (<i>register</i>) on page A8-548
			10	Vector Bitwise OR (if source registers differ)	<i>VORR</i> (<i>register</i>) on page A8-680
				Vector Move (if source registers identical)	<i>VMOV</i> (<i>register</i>) on page A8-642
	11	Vector Bitwise OR NOT	<i>VORN</i> (<i>register</i>) on page A8-676		
	1	00	Vector Bitwise Exclusive OR	<i>VEOR</i> on page A8-596	
		01	Vector Bitwise Select	<i>VBIF</i> , <i>VBIT</i> , <i>VBSL</i> on page A8-550	
		10	Vector Bitwise Insert if True	<i>VBIF</i> , <i>VBIT</i> , <i>VBSL</i> on page A8-550	
11	Vector Bitwise Insert if False	<i>VBIF</i> , <i>VBIT</i> , <i>VBSL</i> on page A8-550			
0010	0	-	-	Vector Halving Subtract	<i>VHADD</i> , <i>VHSUB</i> on page A8-600
	1	-	-	Vector Saturating Subtract	<i>VQSUB</i> on page A8-724
0011	0	-	-	Vector Compare Greater Than	<i>VCGT</i> (<i>register</i>) on page A8-560
	1	-	-	Vector Compare Greater Than or Equal	<i>VCGE</i> (<i>register</i>) on page A8-556

Table A7-9 Three registers of the same length (continued)

A	B	U	C	Instruction	See
0100	0	-	-	Vector Shift Left	<i>VSHL</i> (register) on page A8-752
	1	-	-	Vector Saturating Shift Left	<i>VQSHL</i> (register) on page A8-718
0101	0	-	-	Vector Rounding Shift Left	<i>VRSHL</i> on page A8-736
	1	-	-	Vector Saturating Rounding Shift Left	<i>VQRSHL</i> on page A8-714
0110	-	-	-	Vector Maximum or Minimum	<i>VMAX</i> , <i>VMIN</i> (integer) on page A8-630
0111	0	-	-	Vector Absolute Difference	<i>VABD</i> , <i>VABDL</i> (integer) on page A8-528
	1	-	-	Vector Absolute Difference and Accumulate	<i>VABA</i> , <i>VABAL</i> on page A8-526
1000	0	0	-	Vector Add	<i>VADD</i> (integer) on page A8-536
		1	-	Vector Subtract	<i>VSUB</i> (integer) on page A8-788
	1	0	-	Vector Test Bits	<i>VTST</i> on page A8-802
		1	-	Vector Compare Equal	<i>VCEQ</i> (register) on page A8-552
1001	0	-	-	Vector Multiply Accumulate or Subtract	<i>VMLA</i> , <i>VMLAL</i> , <i>VMLS</i> , <i>VMLSL</i> (integer) on page A8-634
	1	-	-	Vector Multiply	<i>VMUL</i> , <i>VMULL</i> (integer and polynomial) on page A8-662
1010	-	-	-	Vector Pairwise Maximum or Minimum	<i>VPMAX</i> , <i>VPMIN</i> (integer) on page A8-690
1011	0	0	-	Vector Saturating Doubling Multiply Returning High Half	<i>VQDMULH</i> on page A8-704
		1	-	Vector Saturating Rounding Doubling Multiply Returning High Half	<i>VQRDMULH</i> on page A8-712
	1	0	-	Vector Pairwise Add	<i>VPADD</i> (integer) on page A8-684

Table A7-9 Three registers of the same length (continued)

A	B	U	C	Instruction	See	
1101	0	0	0x	Vector Add	<i>VADD</i> (floating-point) on page A8-538	
			1x	Vector Subtract	<i>VSUB</i> (floating-point) on page A8-790	
	1	0x	0x	Vector Pairwise Add	<i>VPADD</i> (floating-point) on page A8-686	
			1x	Vector Absolute Difference	<i>VABD</i> (floating-point) on page A8-530	
1	0	-	0x	Vector Multiply Accumulate or Subtract	<i>VMLA</i> , <i>VMLS</i> (floating-point) on page A8-636	
			1x	Vector Multiply	<i>VMUL</i> (floating-point) on page A8-664	
1110	0	0	0x	Vector Compare Equal	<i>VCEQ</i> (register) on page A8-552	
			1	0x	Vector Compare Greater Than or Equal	<i>VCGE</i> (register) on page A8-556
				1x	Vector Compare Greater Than	<i>VCGT</i> (register) on page A8-560
1	1	-	Vector Absolute Compare Greater or Less Than (or Equal)	<i>VACGE</i> , <i>VACGT</i> , <i>VACLE</i> , <i>VACLT</i> on page A8-534		
1111	0	0	-	Vector Maximum or Minimum	<i>VMAX</i> , <i>VMIN</i> (floating-point) on page A8-632	
			1	-	Vector Pairwise Maximum or Minimum	<i>VPMAX</i> , <i>VPMIN</i> (floating-point) on page A8-692
	1	0	0x	Vector Reciprocal Step	<i>VRECPS</i> on page A8-730	
0		1x	Vector Reciprocal Square Root Step	<i>VRSQRTS</i> on page A8-744		

A7.4.2 Three registers of different lengths

Thumb encoding

15	14	13	12	11	10	9	8	7	6	5	4	3	2	1	0	15	14	13	12	11	10	9	8	7	6	5	4	3	2	1	0
1	1	1	U	1	1	1	1	1		B												A		0	0						

ARM encoding

31	30	29	28	27	26	25	24	23	22	21	20	19	18	17	16	15	14	13	12	11	10	9	8	7	6	5	4	3	2	1	0																	
1	1	1	1	0	0	1	U	1			B																											A		0	0							

If B == 0b11, see *Advanced SIMD data-processing instructions* on page A7-10.

Table A7-10 shows the allocation of encodings in this space. Other encodings in this space are UNDEFINED.

Table A7-10 Data-processing instructions with three registers of different lengths

A	U	Instruction	See
000x	-	Vector Add Long or Wide	<i>VADDL</i> , <i>VADDW</i> on page A8-542
001x	-	Vector Subtract Long or Wide	<i>VSUBL</i> , <i>VSUBW</i> on page A8-794
0100	0	Vector Add and Narrow, returning High Half	<i>VADDHN</i> on page A8-540
	1	Vector Rounding Add and Narrow, returning High Half	<i>VRADDHN</i> on page A8-726
0101	-	Vector Absolute Difference and Accumulate	<i>VABA</i> , <i>VABAL</i> on page A8-526
0110	0	Vector Subtract and Narrow, returning High Half	<i>VSUBHN</i> on page A8-792
	1	Vector Rounding Subtract and Narrow, returning High Half	<i>VRSUBHN</i> on page A8-748
0111	-	Vector Absolute Difference	<i>VABD</i> , <i>VABDL</i> (<i>integer</i>) on page A8-528
10x0	-	Vector Multiply Accumulate or Subtract	<i>VMLA</i> , <i>VMLAL</i> , <i>VMLS</i> , <i>VMLSL</i> (<i>integer</i>) on page A8-634
10x1	0	Vector Saturating Doubling Multiply Accumulate or Subtract Long	<i>VQDMLAL</i> , <i>VQDMLSL</i> on page A8-702
1100	-	Vector Multiply (<i>integer</i>)	<i>VMUL</i> , <i>VMULL</i> (<i>integer and polynomial</i>) on page A8-662
1101	0	Vector Saturating Doubling Multiply Long	<i>VQDMULL</i> on page A8-706
1110	-	Vector Multiply (<i>polynomial</i>)	<i>VMUL</i> , <i>VMULL</i> (<i>integer and polynomial</i>) on page A8-662

A7.4.3 Two registers and a scalar**Thumb encoding**

15	14	13	12	11	10	9	8	7	6	5	4	3	2	1	0	15	14	13	12	11	10	9	8	7	6	5	4	3	2	1	0
1	1	1	U	1	1	1	1	1			B											A			1		0				

ARM encoding

31	30	29	28	27	26	25	24	23	22	21	20	19	18	17	16	15	14	13	12	11	10	9	8	7	6	5	4	3	2	1	0
1	1	1	1	0	0	1	U	1			B												A			1		0			

If B == 0b11, see *Advanced SIMD data-processing instructions* on page A7-10.

Table A7-11 shows the allocation of encodings in this space. Other encodings in this space are UNDEFINED.

Table A7-11 Data-processing instructions with two registers and a scalar

A	U	Instruction	See
0x0x	-	Vector Multiply Accumulate or Subtract	<i>VMLA, VMLAL, VMLS, VMLS</i> (by scalar) on page A8-638
0x10	-	Vector Multiply Accumulate or Subtract Long	<i>VMLA, VMLAL, VMLS, VMLS</i> (by scalar) on page A8-638
0x11	0	Vector Saturating Doubling Multiply Accumulate or Subtract Long	<i>VQDMLAL, VQDMLS</i> on page A8-702
100x	-	Vector Multiply	<i>VMUL, VMULL</i> (by scalar) on page A8-666
1010	-	Vector Multiply Long	<i>VMUL, VMULL</i> (by scalar) on page A8-666
1011	0	Vector Saturating Doubling Multiply Long	<i>VQDMULL</i> on page A8-706
1100	-	Vector Saturating Doubling Multiply returning High Half	<i>VQDMULH</i> on page A8-704
1101	-	Vector Saturating Rounding Doubling Multiply returning High Half	<i>VQRDMULH</i> on page A8-712

A7.4.4 Two registers and a shift amount

Thumb encoding

15	14	13	12	11	10	9	8	7	6	5	4	3	2	1	0	15	14	13	12	11	10	9	8	7	6	5	4	3	2	1	0
1	1	1	U	1	1	1	1	1			imm3											A	L	B		1					

ARM encoding

31	30	29	28	27	26	25	24	23	22	21	20	19	18	17	16	15	14	13	12	11	10	9	8	7	6	5	4	3	2	1	0												
1	1	1	1	0	0	1	U	1			imm3																											A	L	B		1	



If [L, imm3] == 0b0000, see *One register and a modified immediate value* on page A7-21.

Table A7-12 shows the allocation of encodings in this space. Other encodings in this space are UNDEFINED.

Table A7-12 Data-processing instructions with two registers and a shift amount

A	U	B	L	Instruction	See
0000	-	-	-	Vector Shift Right	<i>VSHR</i> on page A8-756
0001	-	-	-	Vector Shift Right and Accumulate	<i>VSRA</i> on page A8-764
0010	-	-	-	Vector Rounding Shift Right	<i>VRSHR</i> on page A8-738
0011	-	-	-	Vector Rounding Shift Right and Accumulate	<i>VRSRA</i> on page A8-746
0100	1	-	-	Vector Shift Right and Insert	<i>VSRI</i> on page A8-766
0101	0	-	-	Vector Shift Left	<i>VSHL (immediate)</i> on page A8-750
0101	1	-	-	Vector Shift Left and Insert	<i>VSLI</i> on page A8-760
011x	-	-	-	Vector Saturating Shift Left	<i>VQSHL, VQSHLU (immediate)</i> on page A8-720
1000	0	0	0	Vector Shift Right Narrow	<i>VSHRN</i> on page A8-758
		1		Vector Rounding Shift Right Narrow	<i>VRSHRN</i> on page A8-740
	1	0		Vector Saturating Shift Right, Unsigned Narrow	<i>VQSHRN, VQSHRUN</i> on page A8-722
		1		Vector Saturating Shift Right, Rounded Unsigned Narrow	<i>VQRSHRN, VQRSHRUN</i> on page A8-716
1001	-	0		Vector Saturating Shift Right, Narrow	<i>VQSHRN, VQSHRUN</i> on page A8-722
		1		Vector Saturating Shift Right, Rounded Narrow	<i>VQRSHRN, VQRSHRUN</i> on page A8-716

Table A7-12 Data-processing instructions with two registers and a shift amount (continued)

A	U	B	L	Instruction	See
1010	-	0		Vector Shift Left Long	<i>VSHLL</i> on page A8-754
				Vector Move Long	<i>VMOVL</i> on page A8-654
111x	-	-		Vector Convert	<i>VCVT</i> (between floating-point and fixed-point, <i>Advanced SIMD</i>) on page A8-580

A7.4.5 Two registers, miscellaneous

Thumb encoding

15	14	13	12	11	10	9	8	7	6	5	4	3	2	1	0	15	14	13	12	11	10	9	8	7	6	5	4	3	2	1	0
1	1	1	1	1	1	1	1	1			1	1			A					0			B			0					

ARM encoding

31	30	29	28	27	26	25	24	23	22	21	20	19	18	17	16	15	14	13	12	11	10	9	8	7	6	5	4	3	2	1	0
1	1	1	1	0	0	1	1	1			1	1			A						0			B			0				

The allocation of encodings in this space is shown in Table A7-13. Other encodings in this space are UNDEFINED.

Table A7-13 Instructions with two registers, miscellaneous

A	B	Instruction	See
00	0000x	Vector Reverse in doublewords	<i>VREV16</i> , <i>VREV32</i> , <i>VREV64</i> on page A8-732
	0001x	Vector Reverse in words	<i>VREV16</i> , <i>VREV32</i> , <i>VREV64</i> on page A8-732
	0010x	Vector Reverse in halfwords	<i>VREV16</i> , <i>VREV32</i> , <i>VREV64</i> on page A8-732
	010xx	Vector Pairwise Add Long	<i>VPADDL</i> on page A8-688
	1000x	Vector Count Leading Sign Bits	<i>VCLS</i> on page A8-566
	1001x	Vector Count Leading Zeros	<i>VCLZ</i> on page A8-570
	1010x	Vector Count	<i>VCNT</i> on page A8-574
	1011x	Vector Bitwise NOT	<i>VMVN</i> (<i>register</i>) on page A8-670
	110xx	Vector Pairwise Add and Accumulate Long	<i>VPADAL</i> on page A8-682
	1110x	Vector Saturating Absolute	<i>VQABS</i> on page A8-698
	1111x	Vector Saturating Negate	<i>VQNEG</i> on page A8-710

Table A7-13 Instructions with two registers, miscellaneous (continued)

A	B	Instruction	See
01	x000x	Vector Compare Greater Than Zero	<i>VCGT (immediate #0)</i> on page A8-562
	x001x	Vector Compare Greater Than or Equal to Zero	<i>VCGE (immediate #0)</i> on page A8-558
	x010x	Vector Compare Equal to zero	<i>VCEQ (immediate #0)</i> on page A8-554
	x011x	Vector Compare Less Than or Equal to Zero	<i>VCLE (immediate #0)</i> on page A8-564
	x100x	Vector Compare Less Than Zero	<i>VCLT (immediate #0)</i> on page A8-568
	x110x	Vector Absolute	<i>VABS</i> on page A8-532
	x111x	Vector Negate	<i>VNEG</i> on page A8-672
	0000x	Vector Swap	<i>VSWP</i> on page A8-796
	0001x	Vector Transpose	<i>VTRN</i> on page A8-800
	0010x	Vector Unzip	<i>VUZP</i> on page A8-804
	0011x	Vector Zip	<i>VZIP</i> on page A8-806
10	01000	Vector Move and Narrow	<i>VMOVN</i> on page A8-656
	01001	Vector Saturating Move and Unsigned Narrow	<i>VQMOVN, VQMOVUN</i> on page A8-708
	0101x	Vector Saturating Move and Narrow	<i>VQMOVN, VQMOVUN</i> on page A8-708
	01100	Vector Shift Left Long (maximum shift)	<i>VSHLL</i> on page A8-754
	11x00	Vector Convert	<i>VCVT (between half-precision and single-precision, Advanced SIMD)</i> on page A8-586
11	10x0x	Vector Reciprocal Estimate	<i>VRECPE</i> on page A8-728
	10x1x	Vector Reciprocal Square Root Estimate	<i>VRSQRTE</i> on page A8-742
	11xxx	Vector Convert	<i>VCVT (between floating-point and integer, Advanced SIMD)</i> on page A8-576

10



A7.4.6 One register and a modified immediate value

Thumb encoding

15	14	13	12	11	10	9	8	7	6	5	4	3	2	1	0	15	14	13	12	11	10	9	8	7	6	5	4	3	2	1	0
1	1	1	a	1	1	1	1	1		0	0	0	b	c	d																
																cmode		0		op	1	e	f	g	h						

ARM encoding

31	30	29	28	27	26	25	24	23	22	21	20	19	18	17	16	15	14	13	12	11	10	9	8	7	6	5	4	3	2	1	0
1	1	1	1	0	0	1	a	1		0	0	0	b	c	d																
																cmode		0		op	1	e	f	g	h						

Table A7-14 shows the allocation of encodings in this space.

Table A7-15 on page A7-22 shows the modified immediate constants available with these instructions, and how they are encoded.

Table A7-14 Data-processing instructions with one register and a modified immediate value

op	cmode	Instruction	See
0	0xx0	Vector Move	<i>VMOV (immediate)</i> on page A8-640
	0xx1	Vector Bitwise OR	<i>VORR (immediate)</i> on page A8-678
	10x0	Vector Move	<i>VMOV (immediate)</i> on page A8-640
	10x1	Vector Bitwise OR	<i>VORR (immediate)</i> on page A8-678
	11xx	Vector Move	<i>VMOV (immediate)</i> on page A8-640
1	0xx0	Vector Bitwise NOT	<i>VMVN (immediate)</i> on page A8-668
	0xx1	Vector Bit Clear	<i>VBIC (immediate)</i> on page A8-546
	10x0	Vector Bitwise NOT	<i>VMVN (immediate)</i> on page A8-668
	10x1	Vector Bit Clear	<i>VBIC (immediate)</i> on page A8-546
	110x	Vector Bitwise NOT	<i>VMVN (immediate)</i> on page A8-668
	1110	Vector Move	<i>VMOV (immediate)</i> on page A8-640
	1111	UNDEFINED	-

Table A7-15 Modified immediate values for Advanced SIMD instructions

op	cmode	Constant ^a	<dt> ^b	Notes
-	000x	00000000 00000000 00000000 abcdefgh 00000000 00000000 00000000 abcdefgh	I32	c
	001x	00000000 00000000 abcdefgh 00000000 00000000 00000000 abcdefgh 00000000	I32	c, d
	010x	00000000 abcdefgh 00000000 00000000 00000000 abcdefgh 00000000 00000000	I32	c, d
	011x	abcdefgh 00000000 00000000 00000000 abcdefgh 00000000 00000000 00000000	I32	c, d
	100x	00000000 abcdefgh 00000000 abcdefgh 00000000 abcdefgh 00000000 abcdefgh	I16	c
	101x	abcdefgh 00000000 abcdefgh 00000000 abcdefgh 00000000 abcdefgh 00000000	I16	c, d
	1100	00000000 00000000 abcdefgh 11111111 00000000 00000000 abcdefgh 11111111	I32	d, e
	1101	00000000 abcdefgh 11111111 11111111 00000000 abcdefgh 11111111 11111111	I32	d, e
0	1110	abcdefgh abcdefgh abcdefgh abcdefgh abcdefgh abcdefgh abcdefgh abcdefgh	I8	f
1	1110	aaaaaaaa bbbbbbbb cccccccc dddddddd eeeeeeee ffffffff gggggggg hhhhhhhh	I64	f
0	1111	aBbbbbc defgh000 00000000 00000000 aBbbbbc defgh000 00000000 00000000	F32	f, g
1	1111	UNDEFINED	-	-

- a. In this table, the immediate value is shown in binary form, to relate abcdefgh to the encoding diagram. In assembler syntax, the constant is specified by a data type and a value of that type. That value is specified in the normal way (a decimal number by default) and is replicated enough times to fill the 64-bit immediate. For example, a data type of I32 and a value of 10 specify the 64-bit constant `0x0000000A0000000A`.
- b. This specifies the data type used when the instruction is disassembled. On assembly, the data type must be matched in the table if possible. Other data types are permitted as pseudo-instructions when code is assembled, provided the 64-bit constant specified by the data type and value is available for the instruction (if it is available in more than one way, the first entry in this table that can produce it is used). For example, `VMOV.I64 D0, #0x8000000080000000` does not specify a 64-bit constant that is available from the I64 line of the table, but does specify one that is available from the fourth I32 line or the F32 line. It is assembled to the former, and therefore is disassembled as `VMOV.I32 D0, #0x80000000`.
- c. This constant is available for the VBIC, VMOV, VMVN, and VORR instructions.
- d. UNPREDICTABLE if abcdefgh == 00000000.
- e. This constant is available for the VMOV and VMVN instructions only.
- f. This constant is available for the VMOV instruction only.
- g. In this entry, $B = \text{NOT}(b)$. The bit pattern represents the floating-point number $(-1)^S * 2^{\text{exp}} * \text{mantissa}$, where $S = \text{UInt}(a)$, $\text{exp} = \text{UInt}(\text{NOT}(b):c:d) - 3$ and $\text{mantissa} = (16 + \text{UInt}(e:f:g:h)) / 16$.

Operation

```

// AdvSIMDEExpandImm()
// =====

bits(64) AdvSIMDEExpandImm(bit op, bits(4) cmode, bits(8) imm8)

case cmode<3:1> of
  when '000'
    testimm8 = FALSE; imm64 = Replicate(Zeros(24):imm8, 2);
  when '001'
    testimm8 = TRUE; imm64 = Replicate(Zeros(16):imm8:Zeros(8), 2);
  when '010'
    testimm8 = TRUE; imm64 = Replicate(Zeros(8):imm8:Zeros(16), 2);
  when '011'
    testimm8 = TRUE; imm64 = Replicate(imm8:Zeros(24), 2);
  when '100'
    testimm8 = FALSE; imm64 = Replicate(Zeros(8):imm8, 4);
  when '101'
    testimm8 = TRUE; imm64 = Replicate(imm8:Zeros(8), 4);
  when '110'
    testimm8 = TRUE;
    if cmode<0> == '0' then
      imm64 = Replicate(Zeros(16):imm8:Ones(8), 2);
    else
      imm64 = Replicate(Zeros(8):imm8:Ones(16), 2);
  when '111'
    testimm8 = FALSE;
    if cmode<0> == '0' && op == '0' then
      imm64 = Replicate(imm8, 8);
    if cmode<0> == '0' && op == '1' then
      imm8a = Replicate(imm8<7>, 8); imm8b = Replicate(imm8<6>, 8);
      imm8c = Replicate(imm8<5>, 8); imm8d = Replicate(imm8<4>, 8);
      imm8e = Replicate(imm8<3>, 8); imm8f = Replicate(imm8<2>, 8);
      imm8g = Replicate(imm8<1>, 8); imm8h = Replicate(imm8<0>, 8);
      imm64 = imm8a:imm8b:imm8c:imm8d:imm8e:imm8f:imm8g:imm8h;
    if cmode<0> == '1' && op == '0' then
      imm32 = imm8<7>:NOT(imm8<6>):Replicate(imm8<6>,5):imm8<5:0>:Zeros(19);
      imm64 = Replicate(imm32, 2);
    if cmode<0> == '1' && op == '1' then
      UNDEFINED;

if testimm8 && imm8 == '00000000' then
  UNPREDICTABLE;

return imm64;

```

A7.5 VFP data-processing instructions

Thumb encoding

15	14	13	12	11	10	9	8	7	6	5	4	3	2	1	0	15	14	13	12	11	10	9	8	7	6	5	4	3	2	1	0
1	1	1	T	1	1	1	0	opc1				opc2								1	0	1	opc3		0	opc4					

ARM encoding

31	30	29	28	27	26	25	24	23	22	21	20	19	18	17	16	15	14	13	12	11	10	9	8	7	6	5	4	3	2	1	0
cond				1	1	1	0	opc1				opc2								1	0	1	opc3		0	opc4					

If T == 1 in the Thumb encoding or cond == 0b1111 in the ARM encoding, the instruction is UNDEFINED.

Otherwise:

- Table A7-16 shows the encodings for three-register VFP data-processing instructions. Other encodings in this space are UNDEFINED.
- Table A7-17 on page A7-25 applies only if Table A7-16 indicates that it does. It shows the encodings for VFP data-processing instructions with two registers or a register and an immediate. Other encodings in this space are UNDEFINED.
- Table A7-18 on page A7-25 shows the immediate constants available in the VMOV (immediate) instruction.

These instructions are CDP instructions for coprocessors 10 and 11.

Table A7-16 Three-register VFP data-processing instructions

opc1	opc3	Instruction	See
0x00	-	Vector Multiply Accumulate or Subtract	<i>VMLA</i> , <i>VMLS</i> (<i>floating-point</i>) on page A8-636
0x01	-	Vector Negate Multiply Accumulate or Subtract	<i>VNMLA</i> , <i>VNMLS</i> , <i>VNMUL</i> on page A8-674
0x10	x1		
	x0	Vector Multiply	<i>VMUL</i> (<i>floating-point</i>) on page A8-664
0x11	x0	Vector Add	<i>VADD</i> (<i>integer</i>) on page A8-536
	x1	Vector Subtract	<i>VSUB</i> (<i>integer</i>) on page A8-788
1x00	x0	Vector Divide	<i>VDIV</i> on page A8-590
1x11	-	Other VFP data-processing instructions	Table A7-17 on page A7-25

Table A7-17 Other VFP data-processing instructions

opc2	opc3	Instruction	See
-	x0	Vector Move	<i>VMOV (immediate)</i> on page A8-640
0000	01	Vector Move	<i>VMOV (register)</i> on page A8-642
	11	Vector Absolute	<i>VABS</i> on page A8-532
0001	01	Vector Negate	<i>VNEG</i> on page A8-672
	11	Vector Square Root	<i>VSQRT</i> on page A8-762
001x	x1	Vector Convert	<i>VCVTB, VCVTT</i> (between half-precision and single-precision, VFP) on page A8-588
010x	x1	Vector Compare	<i>VCMP, VCMPE</i> on page A8-572
0111	11	Vector Convert	<i>VCVT</i> (between double-precision and single-precision) on page A8-584
1000	x1	Vector Convert	<i>VCVT, VCVTR</i> (between floating-point and integer, VFP) on page A8-578
101x	x1	Vector Convert	<i>VCVT</i> (between floating-point and fixed-point, VFP) on page A8-582
110x	x1	Vector Convert	<i>VCVT, VCVTR</i> (between floating-point and integer, VFP) on page A8-578
111x	x1	Vector Convert	<i>VCVT</i> (between floating-point and fixed-point, VFP) on page A8-582

Table A7-18 VFP modified immediate constants

Data type	opc2	opc4	Constant ^a
F32	abcd	efgh	aBbbbbbc defgh000 00000000 00000000
F64	abcd	efgh	aBbbbbbb bbcdefgh 00000000 00000000 00000000 00000000 00000000 00000000

a. In this column, B = NOT(b). The bit pattern represents the floating-point number $(-1)^S * 2^{\text{exp}} * \text{mantissa}$, where $S = \text{UInt}(a)$, $\text{exp} = \text{UInt}(\text{NOT}(b):c:d)-3$ and $\text{mantissa} = (\text{16} + \text{UInt}(e:f:g:h))/16$.

A7.5.1 Operation

```
// VFPEExpandImm()
// =====

bits(N) VFPEExpandImm(bits(8) imm8, integer N)
  assert N == 32 || N == 64;
  if N == 32 then
    return imm8<7>:NOT(imm8<6>):Replicate(imm8<6>,5):imm8<5:0>:Zeros(19);
  else
    return imm8<7>:NOT(imm8<6>):Replicate(imm8<6>,8):imm8<5:0>:Zeros(48);
```

A7.6 Extension register load/store instructions

Thumb encoding

15	14	13	12	11	10	9	8	7	6	5	4	3	2	1	0	15	14	13	12	11	10	9	8	7	6	5	4	3	2	1	0
1	1	1	T	1	1	0	Opcode				Rn								1	0	1										

ARM encoding

31	30	29	28	27	26	25	24	23	22	21	20	19	18	17	16	15	14	13	12	11	10	9	8	7	6	5	4	3	2	1	0
cond				1	1	0	Opcode				Rn								1	0	1										

If T == 1 in the Thumb encoding or cond == 0b1111 in the ARM encoding, the instruction is UNDEFINED.

Otherwise, the allocation of encodings in this space is shown in Table A7-19. Other encodings in this space are UNDEFINED.

These instructions are LDC and STC instructions for coprocessors 10 and 11.

Table A7-19 Extension register load/store instructions

Opcode	Rn	Instruction	See
0010x	-	-	<i>64-bit transfers between ARM core and extension registers on page A7-32</i>
01x00	-	Vector Store Multiple (Increment After, no writeback)	<i>VSTM on page A8-784</i>
01x10	-	Vector Store Multiple (Increment After, writeback)	<i>VSTM on page A8-784</i>
1xx00	-	Vector Store Register	<i>VSTR on page A8-786</i>
10x10	not 1101	Vector Store Multiple (Decrement Before, writeback)	<i>VSTM on page A8-784</i>
	1101	Vector Push Registers	<i>VPUSH on page A8-696</i>
01x01	-	Vector Load Multiple (Increment After, no writeback)	<i>VLDM on page A8-626</i>
01x11	not 1101	Vector Load Multiple (Increment After, writeback)	<i>VLDM on page A8-626</i>
	1101	Vector Pop Registers	<i>VPOP on page A8-694</i>
1xx01	-	Vector Load Register	<i>VLDR on page A8-628</i>
10x11	-	Vector Load Multiple (Decrement Before, writeback)	<i>VLDM on page A8-626</i>

A7.7 Advanced SIMD element or structure load/store instructions

Thumb encoding

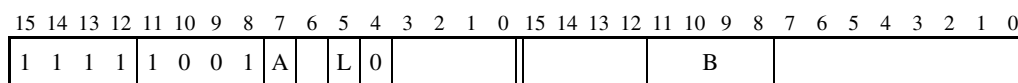

ARM encoding

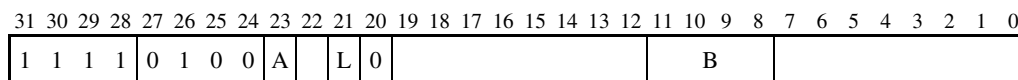

The allocation of encodings in this space is shown in:

- Table A7-20 if L == 0, store instructions
- Table A7-21 on page A7-28 if L == 1, load instructions.

Other encodings in this space are UNDEFINED.

The variable bits are in identical locations in the two encodings, after adjusting for the fact that the ARM encoding is held in memory as a single word and the Thumb encoding is held as two consecutive halfwords.

The ARM instructions can only be executed unconditionally. The Thumb instructions can be executed conditionally by using the IT instruction. For details see *IT* on page A8-104.

Table A7-20 Element and structure store instructions (L == 0)

A	B	Instruction	See
0	0010 011x 1010	Vector Store	<i>VST1</i> (multiple single elements) on page A8-768
	0011 100x	Vector Store	<i>VST2</i> (multiple 2-element structures) on page A8-772
	010x	Vector Store	<i>VST3</i> (multiple 3-element structures) on page A8-776
	000x	Vector Store	<i>VST4</i> (multiple 4-element structures) on page A8-780

Table A7-20 Element and structure store instructions (L == 0) (continued)

A	B	Instruction	See
1	0x00 1000	Vector Store	<i>VST1 (single element from one lane)</i> on page A8-770
	0x01 1001	Vector Store	<i>VST2 (single 2-element structure from one lane)</i> on page A8-774
	0x10 1010	Vector Store	<i>VST3 (single 3-element structure from one lane)</i> on page A8-778
	0x11 1011	Vector Store	<i>VST4 (single 4-element structure from one lane)</i> on page A8-782

Table A7-21 Element and structure load instructions (L == 1)

A	B	Instruction	See
0	0010 011x 1010	Vector Load	<i>VLD1 (multiple single elements)</i> on page A8-602
	0011 100x	Vector Load	<i>VLD2 (multiple 2-element structures)</i> on page A8-608
	010x	Vector Load	<i>VLD3 (multiple 3-element structures)</i> on page A8-614
	000x	Vector Load	<i>VLD4 (multiple 4-element structures)</i> on page A8-620

Table A7-21 Element and structure load instructions (L == 1) (continued)

A	B	Instruction	See
1	0x00 1000	Vector Load	<i>VLD1</i> (single element to one lane) on page A8-604
	1100	Vector Load	<i>VLD1</i> (single element to all lanes) on page A8-606
	0x01 1001	Vector Load	<i>VLD2</i> (single 2-element structure to one lane) on page A8-610
	1101	Vector Load	<i>VLD2</i> (single 2-element structure to all lanes) on page A8-612
	0x10 1010	Vector Load	<i>VLD3</i> (single 3-element structure to one lane) on page A8-616
	1110	Vector Load	<i>VLD3</i> (single 3-element structure to all lanes) on page A8-618
	0x11 1011	Vector Load	<i>VLD4</i> (single 4-element structure to one lane) on page A8-622
	1111	Vector Load	<i>VLD4</i> (single 4-element structure to all lanes) on page A8-624

A7.7.1 Advanced SIMD addressing mode

All the element and structure load/store instructions use this addressing mode. There is a choice of three formats:

[<Rn>{@<align>}] The address is contained in ARM core register Rn.
 Rn is not updated by this instruction.
 Encoded as Rm = 0b1111.
 If Rn is encoded as 0b1111, the instruction is UNPREDICTABLE.

[<Rn>{@<align>}]! The address is contained in ARM core register Rn.
 Rn is updated by this instruction: $Rn = Rn + \text{transfer_size}$
 Encoded as Rm = 0b1101.
 transfer_size is the number of bytes transferred by the instruction. This means that, after the instruction is executed, Rn points to the address in memory immediately following the last address loaded from or stored to.
 If Rn is encoded as 0b1111, the instruction is UNPREDICTABLE.
 This addressing mode can also be written as:
 [<Rn>{@align}], #<transfer_size>
 However, disassembly produces the [<Rn>{@align}]! form.

[<Rn>{@<align>}], <Rm>
 The address is contained in ARM core register <Rn>.
 Rn is updated by this instruction: $Rn = Rn + Rm$
 Encoded as Rm = Rm. Rm must not be encoded as 0b1111 or 0b1101 (the PC or the SP).
 If Rn is encoded as 0b1111, the instruction is UNPREDICTABLE.

In all cases, <align> specifies an optional alignment. Details are given in the individual instruction descriptions.

A7.8 8, 16, and 32-bit transfer between ARM core and extension registers

Thumb encoding

15	14	13	12	11	10	9	8	7	6	5	4	3	2	1	0	15	14	13	12	11	10	9	8	7	6	5	4	3	2	1	0
1	1	1	T	1	1	1	0	A	L							1	0	1	C			B	1								

ARM encoding

31	30	29	28	27	26	25	24	23	22	21	20	19	18	17	16	15	14	13	12	11	10	9	8	7	6	5	4	3	2	1	0	
cond				1	1	1	0	A	L												1	0	1	C			B	1				

If T == 1 in the Thumb encoding or cond == 0b1111 in the ARM encoding, the instruction is UNDEFINED.

Otherwise, the allocation of encodings in this space is shown in Table A7-22. Other encodings in this space are UNDEFINED.

These instructions are MRC and MCR instructions for coprocessors 10 and 11.

Table A7-22 8-bit, 16-bit and 32-bit data transfer instructions

L	C	A	B	Instruction	See
0	0	000	-	Vector Move	<i>VMOV</i> (between ARM core register and single-precision register) on page A8-648
		111	-	Move to VFP Special Register from ARM core register	<i>VMSR</i> on page A8-660 <i>VMSR</i> on page B6-29 (System level view)
0	1	0xx	-	Vector Move	<i>VMOV</i> (ARM core register to scalar) on page A8-644
		1xx	0x	Vector Duplicate	<i>VDUP</i> (ARM core register) on page A8-594
1	0	000	-	Vector Move	<i>VMOV</i> (between ARM core register and single-precision register) on page A8-648
		111	-	Move to ARM core register from VFP Special Register	<i>VMRS</i> on page A8-658 <i>VMRS</i> on page B6-27 (System level view)
		1	xxx	Vector Move	<i>VMOV</i> (scalar to ARM core register) on page A8-646

A7.9 64-bit transfers between ARM core and extension registers

Thumb encoding

15	14	13	12	11	10	9	8	7	6	5	4	3	2	1	0	15	14	13	12	11	10	9	8	7	6	5	4	3	2	1	0
1	1	1	T	1	1	0	0	0	1	0						1	0	1	C		op										

ARM encoding

31	30	29	28	27	26	25	24	23	22	21	20	19	18	17	16	15	14	13	12	11	10	9	8	7	6	5	4	3	2	1	0
			cond	1	1	0	0	0	1	0											1	0	1	C		op					

If T == 1 in the Thumb encoding or cond == 0b1111 in the ARM encoding, the instruction is UNDEFINED.

Otherwise, the allocation of encodings in this space is shown in Table A7-23. Other encodings in this space are UNDEFINED.

These instructions are MRRC and MCRR instructions for coprocessors 10 and 11.

Table A7-23 ~~8-bit, 16-bit and 32-bit~~ data transfer instructions

C	op	Instruction
0	00x1	VMOV (between two ARM core registers and two single-precision registers) on page A8-650
1	00x1	VMOV (between two ARM core registers and a doubleword extension register) on page A8-652

Chapter A8

Instruction Details

This chapter describes each instruction. It contains the following sections:

- *Format of instruction descriptions* on page A8-2
- *Standard assembler syntax fields* on page A8-7
- *Conditional execution* on page A8-8
- *Shifts applied to a register* on page A8-10
- *Memory accesses* on page A8-13
- *Alphabetical list of instructions* on page A8-14.

A8.1 Format of instruction descriptions

The instruction descriptions in *Alphabetical list of instructions* on page A8-14 normally use the following format:

- instruction section title
- introduction to the instruction
- instruction encoding(s) with architecture information
- assembler syntax
- pseudocode describing how the instruction operates
- exception information
- notes (where applicable).

Each of these items is described in more detail in the following subsections.

A few instruction descriptions describe alternative mnemonics for other instructions and use an abbreviated and modified version of this format.

A8.1.1 Instruction section title

The instruction section title gives the base mnemonic for the instructions described in the section. When one mnemonic has multiple forms described in separate instruction sections, this is followed by a short description of the form in parentheses. The most common use of this is to distinguish between forms of an instruction in which one of the operands is an immediate value and forms in which it is a register.

Parenthesized text is also used to document the former mnemonic in some cases where a mnemonic has been replaced entirely by another mnemonic in the new assembler syntax.

A8.1.2 Introduction to the instruction

The instruction section title is followed by text that briefly describes the main features of the instruction. This description is not necessarily complete and is not definitive. If there is any conflict between it and the more detailed information that follows, the latter takes priority.

A8.1.3 Instruction encodings

This is a list of one or more instruction encodings. Each instruction encoding is labelled as:

- T1, T2, T3 ... for the first, second, third and any additional Thumb encodings
- A1, A2, A3 ... for the first, second, third and any additional ARM encodings
- E1, E2, E3 ... for the first, second, third and any additional ThumbEE encodings that are not also Thumb encodings.

Where Thumb and ARM encodings are very closely related, the two encodings are described together, for example as encoding T1 / A1.

Each instruction encoding description consists of:

- Information about which architecture variants include the particular encoding of the instruction. This is presented in one of two ways:
 - For instruction encodings that are in the main instruction set architecture, as a list of the architecture variants that include the encoding. See *Architecture versions, profiles, and variants* on page A1-4 for a summary of these variants.
 - For instruction encodings that are in the architecture extensions, as a list of the architecture extensions that include the encoding. See *Architecture extensions* on page A1-6 for a summary of the architecture extensions and the architecture variants that they can extend.

In architecture variant lists:

- ARMv7 means ARMv7-A and ARMv7-R profiles. The architecture variant information in this manual does not cover the ARMv7-M profile.
 - * is used as a wildcard. For example, ARMv5T* means ARMv5T, ARMv5TE, and ARMv5TEJ.
- An assembly syntax that ensures that the assembler selects the encoding in preference to any other encoding. In some cases, multiple syntaxes are given. The correct one to use is sometimes indicated by annotations to the syntax, such as *Inside IT block* and *Outside IT block*. In other cases, the correct one to use can be determined by looking at the assembler syntax description and using it to determine which syntax corresponds to the instruction being disassembled.

There is usually more than one syntax that ensures re-assembly to any particular encoding, and the exact set of syntaxes that do so usually depends on the register numbers, immediate constants and other operands to the instruction. For example, when assembling to the Thumb instruction set, the syntax `AND R0,R0,R8` ensures selection of a 32-bit encoding but `AND R0,R0,R1` selects a 16-bit encoding.

The assembly syntax documented for the encoding is chosen to be the simplest one that ensures selection of that encoding for all operand combinations supported by that encoding. This often means that it includes elements that are only necessary for a small subset of operand combinations. For example, the assembler syntax documented for the 32-bit Thumb `AND (register)` encoding includes the `.W` qualifier to ensure that the 32-bit encoding is selected even for the small proportion of operand combinations for which the 16-bit encoding is also available.

The assembly syntax given for an encoding is therefore a suitable one for a disassembler to disassemble that encoding to. However, disassemblers might wish to use simpler syntaxes when they are suitable for the operand combination, in order to produce more readable disassembled code.

- An encoding diagram, or a Thumb encoding diagram followed by an ARM encoding diagram when they are being described together. This is half-width for 16-bit Thumb encodings and full-width for 32-bit Thumb and ARM encodings. The 32-bit Thumb encodings use a double vertical line between the two halfwords of the instruction to distinguish them from ARM encodings and to act as a reminder that 32-bit Thumb instructions consist of two consecutive halfwords rather than a word.

In particular, if instructions are stored using the standard little-endian instruction endianness, the encoding diagram for an ARM instruction at address `A` shows the bytes at addresses `A+3`, `A+2`, `A+1`, `A` from left to right, but the encoding diagram for a 32-bit Thumb instruction shows them in the order `A+1`, `A` for the first halfword, followed by `A+3`, `A+2` for the second halfword.

- Encoding-specific pseudocode. This is pseudocode that translates the encoding-specific instruction fields into inputs to the encoding-independent pseudocode in the later *Operation* subsection, and that picks out any special cases in the encoding. For a detailed description of the pseudocode used and of the relationship between the encoding diagram, the encoding-specific pseudocode and the encoding-independent pseudocode, see Appendix I *Pseudocode Definition*.

A8.1.4 Assembler syntax

The *Assembly syntax* subsection describes the standard UAL syntax for the instruction.

Each syntax description consists of the following elements:

- One or more syntax prototype lines written in a typewriter font, using the conventions described in *Assembler syntax prototype line conventions* on page A8-5. Each prototype line documents the mnemonic and (where appropriate) operand parts of a full line of assembler code. When there is more than one such line, each prototype line is annotated to indicate required results of the encoding-specific pseudocode. For each instruction encoding, this information can be used to determine whether any instructions matching that encoding are available when assembling that syntax, and if so, which ones.
- The line *where:* followed by descriptions of all of the variable or optional fields of the prototype syntax line.

Some syntax fields are standardized across all or most instructions. *Standard assembler syntax fields* on page A8-7 describes these fields.

By default, syntax fields that specify registers, such as <Rd>, <Rn>, or <Rt>, can be any of R0-R12 or LR in Thumb instructions, and any of R0-R12, SP or LR in ARM instructions. These require that the encoding-specific pseudocode set the corresponding integer variable (such as d, n, or t) to the corresponding register number (0-12 for R0-R12, 13 for SP, 14 for LR). This can normally be done by setting the corresponding bitfield in the instruction (named Rd, Rn, Rt...) to the binary encoding of that number. In the case of 16-bit Thumb encodings, this bitfield is normally of length 3 and so the encoding is only available when one of R0-R7 is specified in the assembler syntax. It is also common for such encodings to use a bitfield name such as Rdn. This indicates that the encoding is only available if <Rd> and <Rn> specify the same register, and that the register number of that register is encoded in the bitfield if they do.

The description of a syntax field that specifies a register sometimes extends or restricts the permitted range of registers or documents other differences from the default rules for such fields. Typical extensions are to permit the use of the SP in Thumb instructions and to permit the use of the PC (using register number 15).

- Where appropriate, text that briefly describes changes from the pre-UAL ARM assembler syntax. Where present, this usually consists of an alternative pre-UAL form of the assembler mnemonic. The pre-UAL ARM assembler syntax does not conflict with UAL, and support for it is a recommended optional extension to UAL, to enable the assembly of pre-UAL ARM assembler source files.

Note

The pre-UAL Thumb assembler syntax is incompatible with UAL and is not documented in the instruction sections. For details see Appendix C *Legacy Instruction Mnemonics*.

Assembler syntax prototype line conventions

The following conventions are used in assembler syntax prototype lines and their subfields:

- < > Any item bracketed by < and > is a short description of a type of value to be supplied by the user in that position. A longer description of the item is normally supplied by subsequent text. Such items often correspond to a similarly named field in an encoding diagram for an instruction. When the correspondence simply requires the binary encoding of an integer value or register number to be substituted into the instruction encoding, it is not described explicitly. For example, if the assembler syntax for an ARM instruction contains an item <Rn> and the instruction encoding diagram contains a 4-bit field named Rn, the number of the register specified in the assembler syntax is encoded in binary in the instruction field. If the correspondence between the assembler syntax item and the instruction encoding is more complex than simple binary encoding of an integer or register number, the item description indicates how it is encoded. This is often done by specifying a required output from the encoding-specific pseudocode, such as `add = TRUE`. The assembler must only use encodings that produce that output.
- { } Any item bracketed by { and } is optional. A description of the item and of how its presence or absence is encoded in the instruction is normally supplied by subsequent text. Many instructions have an optional destination register. Unless otherwise stated, if such a destination register is omitted, it is the same as the immediately following source register in the instruction syntax.
- spaces** Single spaces are used for clarity, to separate items. When a space is obligatory in the assembler syntax, two or more consecutive spaces are used.
- +/- This indicates an optional + or - sign. If neither is coded, + is assumed.

All other characters must be encoded precisely as they appear in the assembler syntax. Apart from { and }, the special characters described above do not appear in the basic forms of assembler instructions documented in this manual. The { and } characters need to be encoded in a few places as part of a variable item. When this happens, the long description of the variable item indicates how they must be used.

A8.1.5 Pseudocode describing how the instruction operates

The *Operation* subsection contains encoding-independent pseudocode that describes the main operation of the instruction. For a detailed description of the pseudocode used and of the relationship between the encoding diagram, the encoding-specific pseudocode and the encoding-independent pseudocode, see Appendix I *Pseudocode Definition*.

A8.1.6 Exception information

The *Exceptions* subsection contains a list of the exceptional conditions that can be caused by execution of the instruction.

Processor exceptions are listed as follows:

- Resets and interrupts (both IRQs and FIQs) are not listed. They can occur before or after the execution of any instruction, and in some cases during the execution of an instruction, but they are not in general caused by the instruction concerned.
- Prefetch Abort exceptions are normally caused by a memory abort when an instruction is fetched, followed by an attempt to execute that instruction. This can happen for any instruction, but is caused by the aborted attempt to fetch the instruction rather than by the instruction itself, and so is not listed. A special case is the BKPT instruction, that is defined as causing a Prefetch Abort exception in some circumstances.
- Data Abort exceptions are listed for all instructions that perform data memory accesses.
- Undefined Instruction exceptions are listed when they are part of the effects of a defined instruction. For example, all coprocessor instructions are defined to produce the Undefined Instruction exception if not accepted by their coprocessor. Undefined Instruction exceptions caused by the execution of an UNDEFINED instruction are not listed, even when the UNDEFINED instruction is a special case of one or more of the encodings of the instruction. Such special cases are instead indicated in the encoding-specific pseudocode for the encoding.
- Supervisor Call and Secure Monitor Call exceptions are listed for the SVC and SMC instructions respectively. Supervisor Call exceptions and the SVC instruction were previously called Software Interrupt exceptions and the SWI instruction. Secure Monitor Call exceptions and the SMC instruction were previously called Secure Monitor interrupts and the SMI instruction.

Floating-point exceptions are listed for instructions that can produce them. *Floating-point exceptions* on page A2-42 describes these exceptions. They do not normally result in processor exceptions.

A8.1.7 Notes

Where appropriate, other notes about the instruction appear under additional subheadings.

———— **Note** —————

Information that was documented in notes in previous versions of the ARM Architecture Reference Manual and its supplements has often been moved elsewhere. For example, operand restrictions on the values of bitfields in an instruction encoding are now normally documented in the encoding-specific pseudocode for that encoding.

—————

A8.2 Standard assembler syntax fields

The following assembler syntax fields are standard across all or most instructions:

- <c> Is an optional field. It specifies the condition under which the instruction is executed. See *Conditional execution* on page A8-8 for the range of available conditions and their encoding. If <c> is omitted, it defaults to *always* (AL).
- <q> Specifies optional assembler qualifiers on the instruction. The following qualifiers are defined:
- .N Meaning narrow, specifies that the assembler must select a 16-bit encoding for the instruction. If this is not possible, an assembler error is produced.
 - .W Meaning wide, specifies that the assembler must select a 32-bit encoding for the instruction. If this is not possible, an assembler error is produced.

If neither .W nor .N is specified, the assembler can select either 16-bit or 32-bit encodings. If both are available, it must select a 16-bit encoding. In a few cases, more than one encoding of the same length can be available for an instruction. The rules for selecting between such encodings are instruction-specific and are part of the instruction description.

———— **Note** —————

When assembling to the ARM instruction set, the .N qualifier produces an assembler error and the .W qualifier has no effect.

—————

Although the instruction descriptions throughout this manual show the <c> and <q> fields without { } around them, these fields are optional as described in this section.

A8.3 Conditional execution

Most ARM instructions, and most Thumb instructions from ARMv6T2 onwards, can be executed conditionally, based on the values of the APSR condition flags. Before ARMv6T2, the only conditional Thumb instruction was the 16-bit conditional branch instruction. Table A8-1 lists the available conditions.

In Thumb instructions, the condition (if it is not AL) is normally encoded in a preceding IT instruction. For details see *Conditional instructions* on page A4-4 and *IT* on page A8-104. Some conditional branch instructions do not require a preceding IT instruction, and include a condition code in their encoding.

In ARM instructions, bits [31:28] of the instruction contain the condition, or contain 1111 for some ARM instructions that can only be executed unconditionally.

Table A8-1 Condition codes

cond	Mnemonic extension	Meaning (integer)	Meaning (floating-point) ^a	Condition flags
0000	EQ	Equal	Equal	Z == 1
0001	NE	Not equal	Not equal, or unordered	Z == 0
0010	CS ^b	Carry set	Greater than, equal, or unordered	C == 1
0011	CC ^c	Carry clear	Less than	C == 0
0100	MI	Minus, negative	Less than	N == 1
0101	PL	Plus, positive or zero	Greater than, equal, or unordered	N == 0
0110	VS	Overflow	Unordered	V == 1
0111	VC	No overflow	Not unordered	V == 0
1000	HI	Unsigned higher	Greater than, or unordered	C == 1 and Z == 0
1001	LS	Unsigned lower or same	Less than or equal	C == 0 or Z == 1
1010	GE	Signed greater than or equal	Greater than or equal	N == V
1011	LT	Signed less than	Less than, or unordered	N != V
1100	GT	Signed greater than	Greater than	Z == 0 and N == V
1101	LE	Signed less than or equal	Less than, equal, or unordered	Z == 1 or N != V
1110	None (AL) ^d	Always (unconditional)	Always (unconditional)	Any

a. Unordered means at least one NaN operand.

b. HS (unsigned higher or same) is a synonym for CS.

c. LO (unsigned lower) is a synonym for CC.

d. AL is an optional mnemonic extension for always, except in IT instructions. For details see *IT* on page A8-104.

A8.3.1 Pseudocode details of conditional execution

The `CurrentCond()` pseudocode function has prototype:

```
bits(4) CurrentCond()
```

and returns a 4-bit condition specifier as follows:

- For ARM instructions, it returns bits[31:28] of the instruction.
- For the T1 and T3 encodings of the Branch instruction (see *B* on page A8-44), it returns the 4-bit 'cond' field of the encoding.
- For all other Thumb and ThumbEE instructions, it returns `ITSTATE.IT<7:4>`. See *ITSTATE* on page A2-17.

The `ConditionPassed()` function uses this condition specifier and the APSR condition flags to determine whether the instruction must be executed:

```
// ConditionPassed()
// =====

boolean ConditionPassed()
    cond = CurrentCond();

    // Evaluate base condition.
    case cond<3:1> of
        when '000' result = (APSR.Z == '1');           // EQ or NE
        when '001' result = (APSR.C == '1');           // CS or CC
        when '010' result = (APSR.N == '1');           // MI or PL
        when '011' result = (APSR.V == '1');           // VS or VC
        when '100' result = (APSR.C == '1') && (APSR.Z == '0'); // HI or LS
        when '101' result = (APSR.N == APSR.V);        // GE or LT
        when '110' result = (APSR.N == APSR.V) && (APSR.Z == '0'); // GT or LE
        when '111' result = TRUE;                       // AL

    // Condition bits '111x' indicate the instruction is always executed. Otherwise,
    // invert condition if necessary.
    if cond<0> == '1' && cond != '1111' then
        result = !result;

    return result;
```

A8.4 Shifts applied to a register

ARM register offset load/store word and unsigned byte instructions can apply a wide range of different constant shifts to the offset register. Both Thumb and ARM data-processing instructions can apply the same range of different constant shifts to the second operand register. For details see *Constant shifts*.

ARM data-processing instructions can apply a register-controlled shift to the second operand register.

A8.4.1 Constant shifts

These are the same in Thumb and ARM instructions, except that the input bits come from different positions.

`<shift>` is an optional shift to be applied to `<Rm>`. It can be any one of:

(omitted)	No shift.
LSL #<n>	Logical shift left <n> bits. 1 <= <n> <= 31.
LSR #<n>	Logical shift right <n> bits. 1 <= <n> <= 32.
ASR #<n>	Arithmetic shift right <n> bits. 1 <= <n> <= 32.
ROR #<n>	Rotate right <n> bits. 1 <= <n> <= 31.
RRX	Rotate right one bit, with extend. Bit [0] is written to <code>shifter_carry_out</code> , bits [31:1] are shifted right one bit, and the Carry Flag is shifted into bit [31].

———— Note —————

Assemblers can permit the use of some or all of `ASR #0`, `LSL #0`, `LSR #0`, and `ROR #0` to specify that no shift is to be performed. This is not standard UAL, and the encoding selected for Thumb instructions might vary between UAL assemblers if it is used. To ensure disassembled code assembles to the original instructions, disassemblers must omit the shift specifier when the instruction specifies no shift.

Similarly, assemblers can permit the use of `#0` in the immediate forms of `ASR`, `LSL`, `LSR`, and `ROR` instructions to specify that no shift is to be performed, that is, that a `MOV (register)` instruction is wanted. Again, this is not standard UAL, and the encoding selected for Thumb instructions might vary between UAL assemblers if it is used. To ensure disassembled code assembles to the original instructions, disassemblers must use the `MOV (register)` syntax when the instruction specifies no shift.

Encoding

The assembler encodes <shift> into two type bits and five immediate bits, as follows:

(omitted)	type = 0b00, immediate = 0.
LSL #<n>	type = 0b00, immediate = <n>.
LSR #<n>	type = 0b01. If <n> < 32, immediate = <n>. If <n> == 32, immediate = 0.
ASR #<n>	type = 0b10. If <n> < 32, immediate = <n>. If <n> == 32, immediate = 0.
ROR #<n>	type = 0b11, immediate = <n>.
RRX	type = 0b11, immediate = 0.

A8.4.2 Register controlled shifts

These are only available in ARM instructions.

<type> is the type of shift to apply to the value read from <Rm>. It must be one of:

ASR	Arithmetic shift right, encoded as type = 0b10
LSL	Logical shift left, encoded as type = 0b00
LSR	Logical shift right, encoded as type = 0b01
ROR	Rotate right, encoded as type = 0b11.

The bottom byte of <Rs> contains the shift amount.

A8.4.3 Pseudocode details of instruction-specified shifts and rotates

```
enumeration SRType (SRType_LSL, SRType_LSR, SRType_ASX, SRType_ROR, SRType_RRX);
```

```
// DecodeImmShift()
// =====
```

```
(SRType, integer) DecodeImmShift(bits(2) type, bits(5) imm5)
```

```
case type of
  when '00'
    shift_t = SRType_LSL; shift_n = UInt(imm5);
  when '01'
    shift_t = SRType_LSR; shift_n = if imm5 == '00000' then 32 else UInt(imm5);
  when '10'
    shift_t = SRType_ASX; shift_n = if imm5 == '00000' then 32 else UInt(imm5);
  when '11'
```

```

        if imm5 == '00000' then
            shift_t = SRTYPE_RRX; shift_n = 1;
        else
            shift_t = SRTYPE_ROR; shift_n = UInt(imm5);

    return (shift_t, shift_n);

// DecodeRegShift()
// =====

SRTYPE DecodeRegShift(bits(2) type)
    case type of
        when '00' shift_t = SRTYPE_LSL;
        when '01' shift_t = SRTYPE_LSR;
        when '10' shift_t = SRTYPE_ASR;
        when '11' shift_t = SRTYPE_ROR;
    return shift_t;

// Shift()
// =====

bits(N) Shift(bits(N) value, SRTYPE type, integer amount, bit carry_in)
    (result, -) = Shift_C(value, type, amount, carry_in);
    return result;

// Shift_C()
// =====

(bits(N), bit) Shift_C(bits(N) value, SRTYPE type, integer amount, bit carry_in)
    assert !(type == SRTYPE_RRX && amount != 1);

    if amount == 0 then
        (result, carry_out) = (value, carry_in);
    else
        case type of
            when SRTYPE_LSL
                (result, carry_out) = LSL_C(value, amount);
            when SRTYPE_LSR
                (result, carry_out) = LSR_C(value, amount);
            when SRTYPE_ASR
                (result, carry_out) = ASR_C(value, amount);
            when SRTYPE_ROR
                (result, carry_out) = ROR_C(value, amount);
            when SRTYPE_RRX
                (result, carry_out) = RRX_C(value, carry_in);

    return (result, carry_out);

```

A8.5 Memory accesses

Commonly, the following addressing modes are permitted for memory access instructions:

Offset addressing

The offset value is applied to an address obtained from the base register. The result is used as the address for the memory access. The value of the base register is unchanged.

The assembly language syntax for this mode is:

[<Rn>, <offset>]

Pre-indexed addressing

The offset value is applied to an address obtained from the base register. The result is used as the address for the memory access, and written back into the base register.

The assembly language syntax for this mode is:

[<Rn>, <offset>]!

Post-indexed addressing

The address obtained from the base register is used, unchanged, as the address for the memory access. The offset value is applied to the address, and written back into the base register.

The assembly language syntax for this mode is:

[<Rn>], <offset>

In each case, <Rn> is the base register. <offset> can be:

- an immediate constant, such as <imm8> or <imm12>
- an index register, <Rm>
- a shifted index register, such as <Rm>, LSL #<shift>.

For information about unaligned access, endianness, and exclusive access, see:

- *Alignment support* on page A3-4
- *Endian support* on page A3-7
- *Synchronization and semaphores* on page A3-12.

A8.6 Alphabetical list of instructions

Every instruction is listed in this section. For details of the format used see *Format of instruction descriptions* on page A8-2.

A8.6.1 ADC (immediate)

Add with Carry (immediate) adds an immediate value and the carry flag value to a register value, and writes the result to the destination register. It can optionally update the condition flags based on the result.

Encoding T1 ARMv6T2, ARMv7

ADC{S}<c> <Rd>, <Rn>, #<const>

15	14	13	12	11	10	9	8	7	6	5	4	3	2	1	0	15	14	13	12	11	10	9	8	7	6	5	4	3	2	1	0
1	1	1	1	0	i	0	1	0	1	0	S	Rn			0	imm3			Rd			imm8									

d = UInt(Rd); n = UInt(Rn); setflags = (S == '1'); imm32 = ThumbExpandImm(i:imm3:imm8);
 if BadReg(d) || BadReg(n) then UNPREDICTABLE;

Encoding A1 ARMv4*, ARMv5T*, ARMv6*, ARMv7

ADC{S}<c> <Rd>, <Rn>, #<const>

31	30	29	28	27	26	25	24	23	22	21	20	19	18	17	16	15	14	13	12	11	10	9	8	7	6	5	4	3	2	1	0
cond		0	0	1	0	1	0	1	S	Rn			Rd			imm12															

if Rd == '1111' && S == '1' then SEE SUBS PC, LR and related instructions;
 d = UInt(Rd); n = UInt(Rn); setflags = (S == '1'); imm32 = ARMEExpandImm(imm12);

Assembler syntax

ADC{S}<C><Q> {<Rd>}, <Rn>, #<const>

where:

- S If S is present, the instruction updates the flags. Otherwise, the flags are not updated.
- <C><Q> See *Standard assembler syntax fields* on page A8-7.
- <Rd> The destination register.
- <Rn> The first operand register.
- <const> The immediate value to be added to the value obtained from <Rn>. See *Modified immediate constants in Thumb instructions* on page A6-17 or *Modified immediate constants in ARM instructions* on page A5-9 for the range of values.

The pre-UAL syntax ADC<C>S is equivalent to ADCS<C>.

Operation

```

if ConditionPassed() then
    EncodingSpecificOperations();
    (result, carry, overflow) = AddWithCarry(R[n], imm32, APSR.C);
    if d == 15 then // Can only occur for ARM encoding
        ALUWritePC(result); // setflags is always FALSE here
    else
        R[d] = result;
        if setflags then
            APSR.N = result<31>;
            APSR.Z = IsZeroBit(result);
            APSR.C = carry;
            APSR.V = overflow;

```

Exceptions

None.

A8.6.2 ADC (register)

Add with Carry (register) adds a register value, the carry flag value, and an optionally-shifted register value, and writes the result to the destination register. It can optionally update the condition flags based on the result.

Encoding T1 ARMv4T, ARMv5T*, ARMv6*, ARMv7

ADCS <Rdn>, <Rm>

Outside IT block.

ADC<c> <Rdn>, <Rm>

Inside IT block.

15	14	13	12	11	10	9	8	7	6	5	4	3	2	1	0
0	1	0	0	0	0	0	1	0	1	Rm				Rdn	

```
d = UInt(Rdn); n = UInt(Rdn); m = UInt(Rm); setflags = !InITBlock();
(shift_t, shift_n) = (SRTYPE_LSL, 0);
```

Encoding T2 ARMv6T2, ARMv7

ADC{S}<c>.W <Rd>, <Rn>, <Rm>{, <shift>}

15	14	13	12	11	10	9	8	7	6	5	4	3	2	1	0	15	14	13	12	11	10	9	8	7	6	5	4	3	2	1	0
1	1	1	0	1	0	1	1	0	1	0	S	Rn	(0)	imm3	Rd	imm2	type	Rm													

```
d = UInt(Rd); n = UInt(Rn); m = UInt(Rm); setflags = (S == '1');
(shift_t, shift_n) = DecodeImmShift(type, imm3:imm2);
if BadReg(d) || BadReg(n) || BadReg(m) then UNPREDICTABLE;
```

Encoding A1 ARMv4*, ARMv5T*, ARMv6*, ARMv7

ADC{S}<c> <Rd>, <Rn>, <Rm>{, <shift>}

31	30	29	28	27	26	25	24	23	22	21	20	19	18	17	16	15	14	13	12	11	10	9	8	7	6	5	4	3	2	1	0
cond	0	0	0	0	1	0	1	S	Rn	Rd	imm5	type	0	Rm																	

```
if Rd == '1111' && S == '1' then SEE SUBS PC, LR and related instructions;
d = UInt(Rd); n = UInt(Rn); m = UInt(Rm); setflags = (S == '1');
(shift_t, shift_n) = DecodeImmShift(type, imm5);
```

Assembler syntax

ADC{S}<C><Q> {<Rd>}, <Rn>, <Rm> {,<shift>}

where:

S	If S is present, the instruction updates the flags. Otherwise, the flags are not updated.
<C><Q>	See <i>Standard assembler syntax fields</i> on page A8-7.
<Rd>	The destination register. ↴
<Rn>	The first operand register. ↴
<Rm>	The optionally shifted second operand register. ↴
<shift>	The shift to apply to the value read from <Rm>. If present, encoding T1 is not permitted. If absent, no shift is applied and any encoding is permitted. <i>Shifts applied to a register</i> on page A8-10 describes the shifts and how they are encoded.

In Thumb assembly:

- outside an IT block, if ADCS <Rd>, <Rn>, <Rd> has <Rd> and <Rn> both in the range R0-R7, it is assembled using encoding T1 as though ADCS <Rd>, <Rn> had been written.
- inside an IT block, if ADC<C> <Rd>, <Rn>, <Rd> has <Rd> and <Rn> both in the range R0-R7, it is assembled using encoding T1 as though ADC<C> <Rd>, <Rn> had been written.

To prevent either of these happening, use the .W qualifier.

The pre-UAL syntax ADC<C>S is equivalent to ADCS<C>.

Operation

```

if ConditionPassed() then
    EncodingSpecificOperations();
    shifted = Shift(R[m], shift_t, shift_n, APSR.C);
    (result, carry, overflow) = AddWithCarry(R[n], shifted, APSR.C);
    if d == 15 then // Can only occur for ARM encoding
        ALUWritePC(result); // setflags is always FALSE here
    else
        R[d] = result;
        if setflags then
            APSR.N = result<31>;
            APSR.Z = IsZeroBit(result);
            APSR.C = carry;
            APSR.V = overflow;

```

Exceptions

None.

A8.6.3 ADC (register-shifted register)

Add with Carry (register-shifted register) adds a register value, the carry flag value, and a register-shifted register value. It writes the result to the destination register, and can optionally update the condition flags based on the result.

Encoding A1 ARMv4*, ARMv5T*, ARMv6*, ARMv7

ADC{S}<c> <Rd>, <Rn>, <Rm>, <type> <Rs>

31	30	29	28	27	26	25	24	23	22	21	20	19	18	17	16	15	14	13	12	11	10	9	8	7	6	5	4	3	2	1	0
cond				0	0	0	0	1	0	1	S	Rn				Rd				Rs				0	type		1	Rm			

```
d = UInt(Rd); n = UInt(Rn); m = UInt(Rm); s = UInt(Rs);
setflags = (S == '1'); shift_t = DecodeRegShift(type);
if d == 15 || n == 15 || m == 15 || s == 15 then UNPREDICTABLE;
```

Assembler syntax

ADC{S}<C><Q> {<Rd>}, <Rn>, <Rm>, <type> <Rs>

where:

S	If S is present, the instruction updates the flags. Otherwise, the flags are not updated.								
<C><Q>	See <i>Standard assembler syntax fields</i> on page A8-7.								
<Rd>	The destination register.								
<Rn>	The first operand register.								
<Rm>	The register that is shifted and used as the second operand.								
<type>	The type of shift to apply to the value read from <Rm>. It must be one of: <table> <tr> <td>ASR</td> <td>Arithmetic shift right, encoded as type = 0b10</td> </tr> <tr> <td>LSL</td> <td>Logical shift left, encoded as type = 0b00</td> </tr> <tr> <td>LSR</td> <td>Logical shift right, encoded as type = 0b01</td> </tr> <tr> <td>ROR</td> <td>Rotate right, encoded as type = 0b11.</td> </tr> </table>	ASR	Arithmetic shift right, encoded as type = 0b10	LSL	Logical shift left, encoded as type = 0b00	LSR	Logical shift right, encoded as type = 0b01	ROR	Rotate right, encoded as type = 0b11.
ASR	Arithmetic shift right, encoded as type = 0b10								
LSL	Logical shift left, encoded as type = 0b00								
LSR	Logical shift right, encoded as type = 0b01								
ROR	Rotate right, encoded as type = 0b11.								
<Rs>	The register whose bottom byte contains the amount to shift by.								

The pre-UAL syntax ADC<C>S is equivalent to ADCS<C>.

Operation

```

if ConditionPassed() then
    EncodingSpecificOperations();
    shift_n = UInt(R[s]<7:0>);
    shifted = Shift(R[m], shift_t, shift_n, APSR.C);
    (result, carry, overflow) = AddWithCarry(R[n], shifted, APSR.C);
    R[d] = result;
    if setflags then
        APSR.N = result<31>;
        APSR.Z = IsZeroBit(result);
        APSR.C = carry;
        APSR.V = overflow;
  
```

Exceptions

None.

A8.6.4 ADD (immediate, Thumb)

This instruction adds an immediate value to a register value, and writes the result to the destination register. It can optionally update the condition flags based on the result.

Encoding T1 ARMv4T, ARMv5T*, ARMv6*, ARMv7
 ADDS <Rd>, <Rn>, #<imm3> Outside IT block.
 ADD<c> <Rd>, <Rn>, #<imm3> Inside IT block.

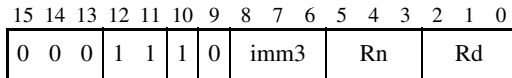

d = UInt(Rd); n = UInt(Rn); setflags = !InITBlock(); imm32 = ZeroExtend(imm3, 32);

Encoding T2 ARMv4T, ARMv5T*, ARMv6*, ARMv7
 ADDS <Rdn>, #<imm8> Outside IT block.
 ADD<c> <Rdn>, #<imm8> Inside IT block.

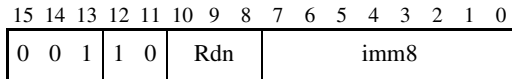

d = UInt(Rdn); n = UInt(Rdn); setflags = !InITBlock(); imm32 = ZeroExtend(imm8, 32);

Encoding T3 ARMv6T2, ARMv7
 ADD{S}<c>.W <Rd>, <Rn>, #<const>

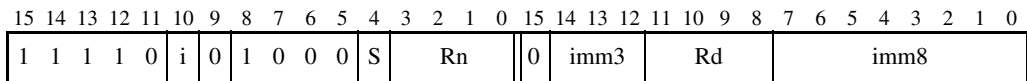

if Rd == '1111' && S == '1' then SEE CMN (immediate);
 if Rn == '1101' then SEE ADD (SP plus immediate);
 d = UInt(Rd); n = UInt(Rn); setflags = (S == '1'); imm32 = ThumbExpandImm(i:imm3:imm8);
 if BadReg(d) || n == 15 then UNPREDICTABLE;

Encoding T4 ARMv6T2, ARMv7
 ADDW<c> <Rd>, <Rn>, #<imm12>

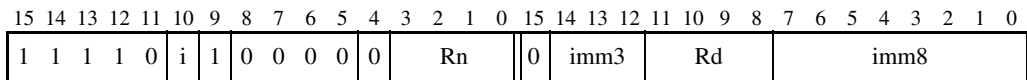

if Rn == '1111' then SEE ADR;
 if Rn == '1101' then SEE ADD (SP plus immediate);
 d = UInt(Rd); n = UInt(Rn); setflags = FALSE; imm32 = ZeroExtend(i:imm3:imm8, 32);
 if BadReg(d) then UNPREDICTABLE;

Assembler syntax

ADD{S}<C><Q> {<Rd>}, <Rn>, #<const> All encodings permitted
 ADDW<C><Q> {<Rd>}, <Rn>, #<const> Only encoding T4 permitted

where:

S If S is present, the instruction updates the flags. Otherwise, the flags are not updated.

<C><Q> See *Standard assembler syntax fields* on page A8-7.

<Rd> The destination register.

<Rn> The first operand register. If <Rn> is SP, see *ADD (SP plus immediate)* on page A8-28. If <Rn> is PC, see *ADR* on page A8-32.

<const> The immediate value to be added to the value obtained from <Rn>. The range of values is 0-7 for encoding T1, 0-255 for encoding T2 and 0-4095 for encoding T4. See *Modified immediate constants in Thumb instructions* on page A6-17 for the range of values for encoding T3.

When multiple encodings of the same length are available for an instruction, encoding T3 is preferred to encoding T4 (if encoding T4 is required, use the ADDW syntax). Encoding T1 is preferred to encoding T2 if <Rd> is specified and encoding T2 is preferred to encoding T1 if <Rd> is omitted.

The pre-UAL syntax ADD<C>S is equivalent to ADDS<C>.

Operation

```
if ConditionPassed() then
    EncodingSpecificOperations();
    (result, carry, overflow) = AddWithCarry(R[n], imm32, '0');
    R[d] = result;
    if setflags then
        APSR.N = result<31>;
        APSR.Z = IsZeroBit(result);
        APSR.C = carry;
        APSR.V = overflow;
```

Exceptions

None.

A8.6.5 ADD (immediate, ARM)

This instruction adds an immediate value to a register value, and writes the result to the destination register. It can optionally update the condition flags based on the result.

Encoding A1 ARMv4*, ARMv5T*, ARMv6*, ARMv7

ADD{S}<C> <Rd>, <Rn>, #<const>

31	30	29	28	27	26	25	24	23	22	21	20	19	18	17	16	15	14	13	12	11	10	9	8	7	6	5	4	3	2	1	0
cond			0	0	1	0	1	0	0	S	Rn				Rd				imm12												

```

if Rn == '1111' && S == '0' then SEE ADR;
if Rn == '1101' then SEE ADD (SP plus immediate);
if Rd == '1111' && S == '1' then SEE SUBS PC, LR and related instructions;
d = UInt(Rd); n = UInt(Rn); setflags = (S == '1'); imm32 = ARMEExpandImm(imm12);
    
```

Assembler syntax

ADD{S}<C><Q> {<Rd>}, <Rn>, #<const>

where:

S If S is present, the instruction updates the flags. Otherwise, the flags are not updated.

<C><Q> See *Standard assembler syntax fields* on page A8-7.

<Rd> The destination register [↗](#)

<Rn> The first operand register. If the SP is specified for <Rn>, see *ADD (SP plus immediate)* on page A8-28. If the PC is specified for <Rn>, see *ADR* on page A8-32.

<const> The immediate value to be added to the value obtained from <Rn>. See *Modified immediate constants in ARM instructions* on page A5-9 for the range of values.

The pre-UAL syntax ADD<C>S is equivalent to ADDS<C>.

Operation

```

if ConditionPassed() then
    EncodingSpecificOperations();
    (result, carry, overflow) = AddWithCarry(R[n], imm32, '0');
    if d == 15 then
        ALUWritePC(result); // setflags is always FALSE here
    else
        R[d] = result;
        if setflags then
            APSR.N = result<31>;
            APSR.Z = IsZeroBit(result);
            APSR.C = carry;
            APSR.V = overflow;

```

Exceptions

None.

A8.6.6 ADD (register)

This instruction adds a register value and an optionally-shifted register value, and writes the result to the destination register. It can optionally update the condition flags based on the result.

Encoding T1 ARMv4T, ARMv5T*, ARMv6*, ARMv7

ADDS <Rd>, <Rn>, <Rm> Outside IT block.

ADD<c> <Rd>, <Rn>, <Rm> Inside IT block.

15	14	13	12	11	10	9	8	7	6	5	4	3	2	1	0
0	0	0	1	1	0	0	Rm		Rn		Rd				

d = UInt(Rd); n = UInt(Rn); m = UInt(Rm); setflags = !InITBlock();

(shift_t, shift_n) = (SRTYPE_LSL, 0);

Encoding T2 ARMv6T2, ARMv7 if <Rdn> and <Rm> are both from R0-R7

ARMv4T, ARMv5T*, ARMv6*, ARMv7 otherwise

ADD<c> <Rdn>, <Rm> If <Rdn> is the PC, must be outside or last in IT block.

15	14	13	12	11	10	9	8	7	6	5	4	3	2	1	0
0	1	0	0	0	1	0	0	DN	Rm		Rdn				

if (DN:Rdn == '1101' || Rm == '1101') then SEE ADD (SP plus register);

d = UInt(DN:Rdn); n = d; m = UInt(Rm); setflags = FALSE; (shift_t, shift_n) = (SRTYPE_LSL, 0);

if n == 15 && m == 15 then UNPREDICTABLE;

if d == 15 && InITBlock() && !LastInITBlock() then UNPREDICTABLE;

Encoding T3 ARMv6T2, ARMv7

ADD{S}<c>.W <Rd>, <Rn>, <Rm>{, <shift>}

15	14	13	12	11	10	9	8	7	6	5	4	3	2	1	0	15	14	13	12	11	10	9	8	7	6	5	4	3	2	1	0
1	1	1	0	1	0	1	1	0	0	0	S	Rn		(0)	imm3	Rd	imm2	type	Rm												

if Rd == '1111' && S == '1' then SEE CMN (register);

if Rn == '1101' then SEE ADD (SP plus register);

d = UInt(Rd); n = UInt(Rn); m = UInt(Rm); setflags = (S == '1');

(shift_t, shift_n) = DecodeImmShift(type, imm3:imm2);

if BadReg(d) || n == 15 || BadReg(m) then UNPREDICTABLE;

Encoding A1 ARMv4*, ARMv5T*, ARMv6*, ARMv7

ADD{S}<c> <Rd>, <Rn>, <Rm>{, <shift>}

31	30	29	28	27	26	25	24	23	22	21	20	19	18	17	16	15	14	13	12	11	10	9	8	7	6	5	4	3	2	1	0
cond		0	0	0	0	1	0	0	S	Rn		Rd		imm5		type	0	Rm													

if Rd == '1111' && S == '1' then SEE SUBS PC, LR and related instructions;

if Rn == '1101' then SEE ADD (SP plus register);

d = UInt(Rd); n = UInt(Rn); m = UInt(Rm); setflags = (S == '1');

(shift_t, shift_n) = DecodeImmShift(type, imm5);

Assembler syntax

ADD{S}<C><Q> {<Rd>}, <Rn>, <Rm> {,<shift>}

where:

S	If S is present, the instruction updates the flags. Otherwise, the flags are not updated.
<C><Q>	See <i>Standard assembler syntax fields</i> on page A8-7.
<Rd>	The destination register. If omitted, <Rd> is the same as <Rn> and encoding T2 is preferred to encoding T1 inside an IT block. If <Rd> is present, encoding T1 is preferred to encoding T2.
<Rn>	The first operand register. If <Rn> is SP, see <i>ADD (SP plus register)</i> on page A8-30.
<Rm>	The register that is optionally shifted and used as the second operand.
<shift>	The shift to apply to the value read from <Rm>. If present, only encoding T3 or A1 is permitted. If omitted, no shift is applied and any encoding is permitted. <i>Shifts applied to a register</i> on page A8-10 describes the shifts and how they are encoded.

In Thumb assembly, inside an IT block, if ADD<C> <Rd>, <Rn>, <Rd> cannot be assembled using encoding T1, it is assembled using encoding T2 as though ADD<C> <Rd>, <Rn> had been written.

To prevent this happening, use the .W qualifier.

The pre-UAL syntax ADD<C>S is equivalent to ADDS<C>.

Operation

```

if ConditionPassed() then
    EncodingSpecificOperations();
    shifted = Shift(R[m], shift_t, shift_n, APSR.C);
    (result, carry, overflow) = AddWithCarry(R[n], shifted, '0');
    if d == 15 then
        ALUWritePC(result); // setflags is always FALSE here
    else
        R[d] = result;
        if setflags then
            APSR.N = result<31>;
            APSR.Z = IsZeroBit(result);
            APSR.C = carry;
            APSR.V = overflow;

```

Exceptions

None.

A8.6.7 ADD (register-shifted register)

Add (register-shifted register) adds a register value and a register-shifted register value. It writes the result to the destination register, and can optionally update the condition flags based on the result.

Encoding A1 ARMv4*, ARMv5T*, ARMv6*, ARMv7

ADD{S}<c> <Rd>, <Rn>, <Rm>, <type> <Rs>

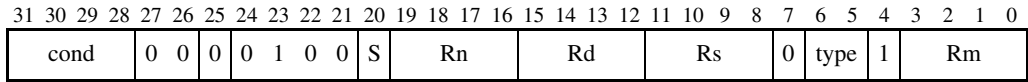

```
d = UInt(Rd); n = UInt(Rn); m = UInt(Rm); s = UInt(Rs);
setflags = (S == '1'); shift_t = DecodeRegShift(type);
if d == 15 || n == 15 || m == 15 || s == 15 then UNPREDICTABLE;
```

Assembler syntax

ADD{S}<C><Q> {<Rd>}, <Rn>, <Rm>, <type> <Rs>

where:

S	If S is present, the instruction updates the flags. Otherwise, the flags are not updated.								
<C><Q>	See <i>Standard assembler syntax fields</i> on page A8-7.								
<Rd>	The destination register.								
<Rn>	The first operand register.								
<Rm>	The register that is shifted and used as the second operand.								
<type>	The type of shift to apply to the value read from <Rm>. It must be one of: <table> <tr> <td>ASR</td> <td>Arithmetic shift right, encoded as type = 0b10</td> </tr> <tr> <td>LSL</td> <td>Logical shift left, encoded as type = 0b00</td> </tr> <tr> <td>LSR</td> <td>Logical shift right, encoded as type = 0b01</td> </tr> <tr> <td>ROR</td> <td>Rotate right, encoded as type = 0b11.</td> </tr> </table>	ASR	Arithmetic shift right, encoded as type = 0b10	LSL	Logical shift left, encoded as type = 0b00	LSR	Logical shift right, encoded as type = 0b01	ROR	Rotate right, encoded as type = 0b11.
ASR	Arithmetic shift right, encoded as type = 0b10								
LSL	Logical shift left, encoded as type = 0b00								
LSR	Logical shift right, encoded as type = 0b01								
ROR	Rotate right, encoded as type = 0b11.								
<Rs>	The register whose bottom byte contains the amount to shift by.								

The pre-UAL syntax ADD<C>S is equivalent to ADDS<C>.

Operation

```

if ConditionPassed() then
    EncodingSpecificOperations();
    shift_n = UInt(R[s]<7:0>);
    shifted = Shift(R[m], shift_t, shift_n, APSR.C);
    (result, carry, overflow) = AddWithCarry(R[n], shifted, '0');
    R[d] = result;
    if setflags then
        APSR.N = result<31>;
        APSR.Z = IsZeroBit(result);
        APSR.C = carry;
        APSR.V = overflow;
  
```

Exceptions

None.

A8.6.8 ADD (SP plus immediate)

This instruction adds an immediate value to the SP value, and writes the result to the destination register.

Encoding T1 ARMv4T, ARMv5T*, ARMv6*, ARMv7

ADD<c> <Rd>,SP,#<imm>

15	14	13	12	11	10	9	8	7	6	5	4	3	2	1	0
1	0	1	0	1				Rd							imm8

d = UInt(Rd); setflags = FALSE; imm32 = ZeroExtend(imm8:'00', 32);

Encoding T2 ARMv4T, ARMv5T*, ARMv6*, ARMv7

ADD<c> SP,SP,#<imm>

15	14	13	12	11	10	9	8	7	6	5	4	3	2	1	0
1	0	1	1	0	0	0	0	0							imm7

d = 13; setflags = FALSE; imm32 = ZeroExtend(imm7:'00', 32);

Encoding T3 ARMv6T2, ARMv7

ADD{S}<c>.W <Rd>,SP,#<const>

15	14	13	12	11	10	9	8	7	6	5	4	3	2	1	0	15	14	13	12	11	10	9	8	7	6	5	4	3	2	1	0
1	1	1	1	0	i	0	1	0	0	0	S	1	1	0	1	0	imm3		Rd						imm8						

if Rd == '1111' && S == '1' then SEE CMN (immediate);

d = UInt(Rd); setflags = (S == '1'); imm32 = ThumbExpandImm(i:imm3:imm8);

if d == 15 then UNPREDICTABLE;

Encoding T4 ARMv6T2, ARMv7

ADDW<c> <Rd>,SP,#<imm12>

15	14	13	12	11	10	9	8	7	6	5	4	3	2	1	0	15	14	13	12	11	10	9	8	7	6	5	4	3	2	1	0
1	1	1	1	0	i	1	0	0	0	0	0	1	1	0	1	0	imm3		Rd						imm8						

d = UInt(Rd); setflags = FALSE; imm32 = ZeroExtend(i:imm3:imm8, 32);

if d == 15 then UNPREDICTABLE;

Encoding A1 ARMv4*, ARMv5T*, ARMv6*, ARMv7

ADD{S}<c> <Rd>,SP,#<const>

31	30	29	28	27	26	25	24	23	22	21	20	19	18	17	16	15	14	13	12	11	10	9	8	7	6	5	4	3	2	1	0
			cond		0	0	1	0	1	0	0	S	1	1	0	1				Rd											imm12

if Rd == '1111' && S == '1' then SEE SUBS PC, LR and related instructions;

d = UInt(Rd); setflags = (S == '1'); imm32 = ARMExpandImm(imm12);

Assembler syntax

ADD{S}<c><q> {<Rd>}, SP, #<const> All encodings permitted
 ADDW<c><q> {<Rd>}, SP, #<const> Only encoding T4 is permitted

where:

S If S is present, the instruction updates the flags. Otherwise, the flags are not updated.

<c><q> See *Standard assembler syntax fields* on page A8-7.

<Rd> The destination register. If omitted, <Rd> is SP.

<const> The immediate value to be added to the value obtained from SP. Values are multiples of 4 in the range 0-1020 for encoding T1, multiples of 4 in the range 0-508 for encoding T2 and any value in the range 0-4095 for encoding T4. See *Modified immediate constants in Thumb instructions* on page A6-17 or *Modified immediate constants in ARM instructions* on page A5-9 for the range of values for encodings T3 and A1.

When both 32-bit encodings are available for an instruction, encoding T3 is preferred to encoding T4 (if encoding T4 is required, use the ADDW syntax).

The pre-UAL syntax ADD<c>S is equivalent to ADDS<c>.

Operation

```
if ConditionPassed() then
    EncodingSpecificOperations();
    (result, carry, overflow) = AddWithCarry(SP, imm32, '0');
    if d == 15 then                    // Can only occur for ARM encoding
        ALUWritePC(result); // setflags is always FALSE here
    else
        R[d] = result;
        if setflags then
            APSR.N = result<31>;
            APSR.Z = IsZeroBit(result);
            APSR.C = carry;
            APSR.V = overflow;
```

Exceptions

None.

A8.6.9 ADD (SP plus register)

This instruction adds an optionally-shifted register value to the SP value, and writes the result to the destination register.

Encoding T1 ARMv4T, ARMv5T*, ARMv6*, ARMv7

ADD<c> <Rdm>, SP, <Rdm>

15	14	13	12	11	10	9	8	7	6	5	4	3	2	1	0
0	1	0	0	0	1	0	0	DM	1	1	0	1	Rdm		

d = UInt(DM:Rdm); m = UInt(DM:Rdm); setflags = FALSE;
 (shift_t, shift_n) = (SRType_LSL, 0);

Encoding T2 ARMv4T, ARMv5T*, ARMv6*, ARMv7

ADD<c> SP, <Rm>

15	14	13	12	11	10	9	8	7	6	5	4	3	2	1	0
0	1	0	0	0	1	0	0	1	Rm	1	0	1			

if Rm == '1101' then SEE encoding T1;
 d = 13; m = UInt(Rm); setflags = FALSE;
 (shift_t, shift_n) = (SRType_LSL, 0);

Encoding T3 ARMv6T2, ARMv7

ADD{S}<c>.W <Rd>, SP, <Rm>{, <shift>}

15	14	13	12	11	10	9	8	7	6	5	4	3	2	1	0	15	14	13	12	11	10	9	8	7	6	5	4	3	2	1	0
1	1	1	0	1	0	1	1	0	0	0	S	1	1	0	1	0	imm3	Rd	imm2	type	Rm										

d = UInt(Rd); m = UInt(Rm); setflags = (S == '1');
 (shift_t, shift_n) = DecodeImmShift(type, imm3:imm2);
 if d == 13 && (shift_t != SRType_LSL || shift_n > 3) then UNPREDICTABLE;
 if d == 15 || BadReg(m) then UNPREDICTABLE;

Encoding A1 ARMv4*, ARMv5T*, ARMv6*, ARMv7

ADD{S}<c> <Rd>, SP, <Rm>{, <shift>}

31	30	29	28	27	26	25	24	23	22	21	20	19	18	17	16	15	14	13	12	11	10	9	8	7	6	5	4	3	2	1	0
cond		0	0	0	0	1	0	0	S	1	1	0	1	Rd	imm5	type	0	Rm													

if Rd == '1111' && S == '1' then SEE SUBS PC, LR and related instructions;
 d = UInt(Rd); m = UInt(Rm); setflags = (S == '1');
 (shift_t, shift_n) = DecodeImmShift(type, imm5);

Assembler syntax

ADD{S}<C><Q> {<Rd>}, SP, <Rm>{, <shift>}

where:

- S If S is present, the instruction updates the flags. Otherwise, the flags are not updated.
- <C><Q> See *Standard assembler syntax fields* on page A8-7.
- <Rd> The destination register. This register can be SP. If omitted, <Rd> is SP. This register can be the PC, but if it is, encoding T3 is not permitted. Using the PC is deprecated.
- <Rm> The register that is optionally shifted and used as the second operand. This register can be the PC, but if it is, encoding T3 is not permitted. Using the PC is deprecated. This register can be SP in both ARM and Thumb instructions, but:
- the use of SP is deprecated
 - when assembling for the Thumb instruction set, only encoding T1 is available and so the instruction can only be ADD SP, SP, SP.
- <shift> The shift to apply to the value read from <Rm>. If omitted, no shift is applied and any encoding is permitted. If present, only encoding T3 or A1 is permitted. *Shifts applied to a register* on page A8-10 describes the shifts and how they are encoded.
- In the Thumb instruction set, if <Rd> is SP or omitted, <shift> is only permitted to be omitted, LSL #1, LSL #2, or LSL #3.

The pre-UAL syntax ADD<C>S is equivalent to ADDS<C>.

Operation

```

if ConditionPassed() then
    EncodingSpecificOperations();
    shifted = Shift(R[m], shift_t, shift_n, APSR.C);
    (result, carry, overflow) = AddWithCarry(SP, shifted, '0');
    if d == 15 then
        ALUWritePC(result); // setflags is always FALSE here
    else
        R[d] = result;
        if setflags then
            APSR.N = result<31>;
            APSR.Z = IsZeroBit(result);
            APSR.C = carry;
            APSR.V = overflow;

```

Exceptions

None.

A8.6.10 ADR

This instruction adds an immediate value to the PC value to form a PC-relative address, and writes the result to the destination register.

Encoding T1 ARMv4T, ARMv5T*, ARMv6*, ARMv7

ADR<c> <Rd>, <label>

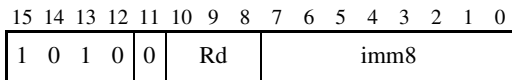

d = UInt(Rd); imm32 = ZeroExtend(imm8:'00', 32); add = TRUE;

Encoding T2 ARMv6T2, ARMv7

ADR<c>.W <Rd>, <label>

<label> before current instruction

SUB <Rd>, PC, #0

Special case for subtraction of zero

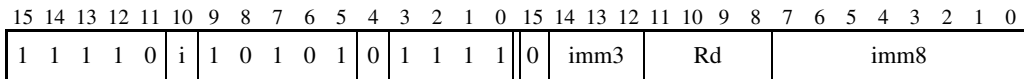

d = UInt(Rd); imm32 = ZeroExtend(i:imm3:imm8, 32); add = FALSE;
if BadReg(d) then UNPREDICTABLE;

Encoding T3 ARMv6T2, ARMv7

ADR<c>.W <Rd>, <label>

<label> after current instruction

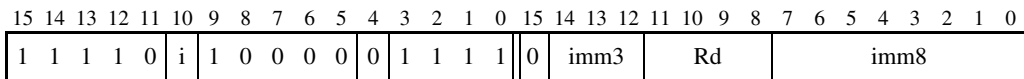

d = UInt(Rd); imm32 = ZeroExtend(i:imm3:imm8, 32); add = TRUE;
if BadReg(d) then UNPREDICTABLE;

Encoding A1 ARMv4*, ARMv5T*, ARMv6*, ARMv7

ADR<c> <Rd>, <label>

<label> after current instruction

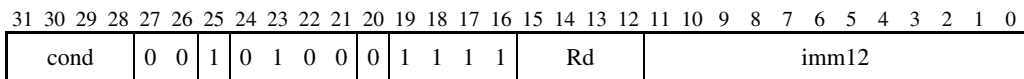

d = UInt(Rd); imm32 = ARMEExpandImm(imm12); add = TRUE;

Encoding A2 ARMv4*, ARMv5T*, ARMv6*, ARMv7

ADR<c> <Rd>, <label>

<label> before current instruction

SUB <Rd>, PC, #0

Special case for subtraction of zero

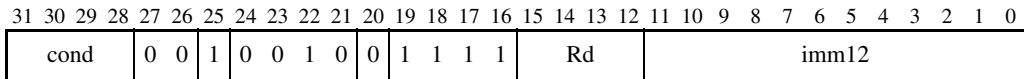

d = UInt(Rd); imm32 = ARMEExpandImm(imm12); add = FALSE;

Assembler syntax

ADR<c><q> <Rd>, <label>	Normal syntax
ADD<c><q> <Rd>, PC, #<const>	Alternative for encodings T1, T3, A1
SUB<c><q> <Rd>, PC, #<const>	Alternative for encoding T2, A2

where:

<c><q>	See <i>Standard assembler syntax fields</i> on page A8-7.
<Rd>	The destination register 4 .
<label>	The label of an instruction or literal data item whose address is to be loaded into <Rd>. The assembler calculates the required value of the offset from the <code>Align(PC,4)</code> value of the ADR instruction to this label. Permitted values of the offset are:

Encoding T1

multiples of 4 in the range -1020 to 1020

Encodings T2 and T3

any value in the range -4095 to 4095

Encodings A1 and A2

plus or minus any of the constants described in *Modified immediate constants in ARM instructions* on page A5-9.

If the offset is zero or positive, encodings T1, T3, and A1 are permitted with `imm32` equal to the offset.

If the offset is negative, encodings T2 and A2 are permitted with `imm32` equal to minus the offset.

The alternative syntax permits the addition or subtraction of the offset and the immediate offset to be specified separately, including permitting a subtraction of 0 that cannot be specified using the normal syntax. For more information, see *Use of labels in UAL instruction syntax* on page A4-5.

Operation

```

if ConditionPassed() then
    EncodingSpecificOperations();
    result = if add then (Align(PC,4) + imm32) else (Align(PC,4) - imm32);
    if d == 15 then // Can only occur for ARM encodings
        ALUWritePC(result);
    else
        R[d] = result;

```

Exceptions

None.

A8.6.11 AND (immediate)

This instruction performs a bitwise AND of a register value and an immediate value, and writes the result to the destination register.

Encoding T1 ARMv6T2, ARMv7

AND{S}<C> <Rd>, <Rn>, #<const>

15	14	13	12	11	10	9	8	7	6	5	4	3	2	1	0	15	14	13	12	11	10	9	8	7	6	5	4	3	2	1	0
1	1	1	1	0	i	0	0	0	0	0	S	Rn				0	imm3				Rd				imm8						

```
if Rd == '1111' && S == '1' then SEE TST (immediate);
d = UInt(Rd); n = UInt(Rn); setflags = (S == '1');
(imm32, carry) = ThumbExpandImm_C(i:imm3:imm8, APSR.C);
if BadReg(d) || BadReg(n) then UNPREDICTABLE;
```

Encoding A1 ARMv4*, ARMv5T*, ARMv6*, ARMv7

AND{S}<C> <Rd>, <Rn>, #<const>

31	30	29	28	27	26	25	24	23	22	21	20	19	18	17	16	15	14	13	12	11	10	9	8	7	6	5	4	3	2	1	0
cond				0	0	1	0	0	0	0	S	Rn				Rd				imm12											

```
if Rd == '1111' && S == '1' then SEE SUBS PC, LR and related instructions;
d = UInt(Rd); n = UInt(Rn); setflags = (S == '1');
(imm32, carry) = ARMEExpandImm_C(imm12, APSR.C);
```

Assembler syntax

AND{S}<C><Q> {<Rd>}, <Rn>, #<const>

where:

- S If S is present, the instruction updates the flags. Otherwise, the flags are not updated.
- <C><Q> See *Standard assembler syntax fields* on page A8-7.
- <Rd> The destination register.
- <Rn> The first operand register.
- <const> The immediate value to be ANDed with the value obtained from <Rn>. See *Modified immediate constants in Thumb instructions* on page A6-17 or *Modified immediate constants in ARM instructions* on page A5-9 for the range of values.

The pre-UAL syntax AND<C>S is equivalent to ANDS<C>.

Operation

```

if ConditionPassed() then
    EncodingSpecificOperations();
    result = R[n] AND imm32;
    if d == 15 then // Can only occur for ARM encoding
        ALUWritePC(result); // setflags is always FALSE here
    else
        R[d] = result;
        if setflags then
            APSR.N = result<31>;
            APSR.Z = IsZeroBit(result);
            APSR.C = carry;
            // APSR.V unchanged

```

Exceptions

None.

A8.6.12 AND (register)

This instruction performs a bitwise AND of a register value and an optionally-shifted register value, and writes the result to the destination register. It can optionally update the condition flags based on the result.

Encoding T1 ARMv4T, ARMv5T*, ARMv6*, ARMv7

ANDS <Rdn>, <Rm> Outside IT block.

AND<c> <Rdn>, <Rm> Inside IT block.

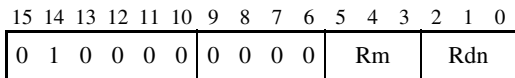

```
d = UInt(Rdn); n = UInt(Rdn); m = UInt(Rm); setflags = !InITBlock();
(shift_t, shift_n) = (SRTYPE_LSL, 0);
```

Encoding T2 ARMv6T2, ARMv7

AND{S}<c>.W <Rd>, <Rn>, <Rm>{, <shift>}

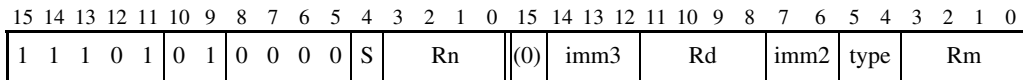

```
if Rd == '1111' && S == '1' then SEE TST (register);
d = UInt(Rd); n = UInt(Rn); m = UInt(Rm); setflags = (S == '1');
(shift_t, shift_n) = DecodeImmShift(type, imm3:imm2);
if BadReg(d) || BadReg(n) || BadReg(m) then UNPREDICTABLE;
```

Encoding A1 ARMv4*, ARMv5T*, ARMv6*, ARMv7

AND{S}<c> <Rd>, <Rn>, <Rm>{, <shift>}

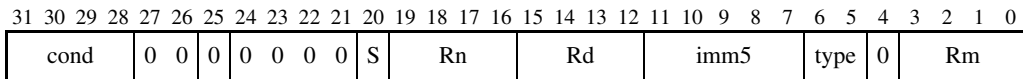

```
if Rd == '1111' && S == '1' then SEE SUBS PC, LR and related instructions;
d = UInt(Rd); n = UInt(Rn); m = UInt(Rm); setflags = (S == '1');
(shift_t, shift_n) = DecodeImmShift(type, imm5);
```

Assembler syntax

AND{S}<C><Q> {<Rd>}, <Rn>, <Rm> {,<shift>}

where:

S	If S is present, the instruction updates the flags. Otherwise, the flags are not updated.
<C><Q>	See <i>Standard assembler syntax fields</i> on page A8-7.
<Rd>	The destination register. ↓
<Rn>	The first operand register. ↓
<Rm>	The register that is optionally shifted and used as the second operand. ↓
<shift>	The shift to apply to the value read from <Rm>. If present, encoding T1 is not permitted. If absent, no shift is applied and all encodings are permitted. <i>Shifts applied to a register</i> on page A8-10 describes the shifts and how they are encoded.

In Thumb assembly:

- outside an IT block, if ANDS <Rd>, <Rn>, <Rd> has <Rd> and <Rn> both in the range R0-R7, it is assembled using encoding T1 as though ANDS <Rd>, <Rn> had been written
- inside an IT block, if AND<C> <Rd>, <Rn>, <Rd> has <Rd> and <Rn> both in the range R0-R7, it is assembled using encoding T1 as though AND<C> <Rd>, <Rn> had been written.

To prevent either of these happening, use the .W qualifier.

The pre-UAL syntax AND<C>S is equivalent to ANDS<C>.

Operation

```

if ConditionPassed() then
    EncodingSpecificOperations();
    (shifted, carry) = Shift_C(R[m], shift_t, shift_n, APSR.C);
    result = R[n] AND shifted;
    if d == 15 then // Can only occur for ARM encoding
        ALUWritePC(result); // setflags is always FALSE here
    else
        R[d] = result;
        if setflags then
            APSR.N = result<31>;
            APSR.Z = IsZeroBit(result);
            APSR.C = carry;
            // APSR.V unchanged

```

Exceptions

None.

A8.6.13 AND (register-shifted register)

This instruction performs a bitwise AND of a register value and a register-shifted register value. It writes the result to the destination register, and can optionally update the condition flags based on the result.

Encoding A1 ARMv4*, ARMv5T*, ARMv6*, ARMv7

AND{S}<c> <Rd>, <Rn>, <Rm>, <type> <Rs>

31 30 29 28 27 26 25 24 23 22 21 20 19 18 17 16 15 14 13 12 11 10 9 8 7 6 5 4 3 2 1 0																															
cond	0	0	0	0	0	0	0	0	S	Rn	Rd	Rs	0	type	1	Rm															

```
d = UInt(Rd); n = UInt(Rn); m = UInt(Rm); s = UInt(Rs);
setflags = (S == '1'); shift_t = DecodeRegShift(type);
if d == 15 || n == 15 || m == 15 || s == 15 then UNPREDICTABLE;
```

Assembler syntax

AND{S}<C><Q> {<Rd>}, <Rn>, <Rm>, <type> <Rs>

where:

S	If S is present, the instruction updates the flags. Otherwise, the flags are not updated.								
<C><Q>	See <i>Standard assembler syntax fields</i> on page A8-7.								
<Rd>	The destination register.								
<Rn>	The first operand register.								
<Rm>	The register that is shifted and used as the second operand.								
<type>	The type of shift to apply to the value read from <Rm>. It must be one of: <table> <tr> <td>ASR</td> <td>Arithmetic shift right, encoded as type = 0b10</td> </tr> <tr> <td>LSL</td> <td>Logical shift left, encoded as type = 0b00</td> </tr> <tr> <td>LSR</td> <td>Logical shift right, encoded as type = 0b01</td> </tr> <tr> <td>ROR</td> <td>Rotate right, encoded as type = 0b11.</td> </tr> </table>	ASR	Arithmetic shift right, encoded as type = 0b10	LSL	Logical shift left, encoded as type = 0b00	LSR	Logical shift right, encoded as type = 0b01	ROR	Rotate right, encoded as type = 0b11.
ASR	Arithmetic shift right, encoded as type = 0b10								
LSL	Logical shift left, encoded as type = 0b00								
LSR	Logical shift right, encoded as type = 0b01								
ROR	Rotate right, encoded as type = 0b11.								
<Rs>	The register whose bottom byte contains the amount to shift by.								

The pre-UAL syntax AND<C>S is equivalent to ANDS<C>.

Operation

```

if ConditionPassed() then
    EncodingSpecificOperations();
    shift_n = UInt(R[s]<7:0>);
    (shifted, carry) = Shift_C(R[m], shift_t, shift_n, APSR.C);
    result = R[n] AND shifted;
    R[d] = result;
    if setflags then
        APSR.N = result<31>;
        APSR.Z = IsZeroBit(result);
        APSR.C = carry;
        // APSR.V unchanged
  
```

Exceptions

None.

A8.6.14 ASR (immediate)

Arithmetic Shift Right (immediate) shifts a register value right by an immediate number of bits, shifting in copies of its sign bit, and writes the result to the destination register. It can optionally update the condition flags based on the result.

Encoding T1 ARMv4T, ARMv5T*, ARMv6*, ARMv7

ASRS <Rd>, <Rm>, #<imm> Outside IT block.

ASR<c> <Rd>, <Rm>, #<imm> Inside IT block.

15	14	13	12	11	10	9	8	7	6	5	4	3	2	1	0
0	0	0	1	0	imm5					Rm			Rd		

```
d = UInt(Rd); m = UInt(Rm); setflags = !InITBlock();
(-, shift_n) = DecodeImmShift('10', imm5);
```

Encoding T2 ARMv6T2, ARMv7

ASR{S}<c>.W <Rd>, <Rm>, #<imm>

15	14	13	12	11	10	9	8	7	6	5	4	3	2	1	0	15	14	13	12	11	10	9	8	7	6	5	4	3	2	1	0
1	1	1	0	1	0	1	0	0	0	1	0	S	1	1	1	1	(0)	imm3			Rd			imm2		1 0		Rm			

```
d = UInt(Rd); m = UInt(Rm); setflags = (S == '1');
(-, shift_n) = DecodeImmShift('10', imm3:imm2);
if BadReg(d) || BadReg(m) then UNPREDICTABLE;
```

Encoding A1 ARMv4*, ARMv5T*, ARMv6*, ARMv7

ASR{S}<c> <Rd>, <Rm>, #<imm>

31	30	29	28	27	26	25	24	23	22	21	20	19	18	17	16	15	14	13	12	11	10	9	8	7	6	5	4	3	2	1	0
cond			0	0	0	1	1	0	1	S	(0)	(0)	(0)	(0)	Rd			imm5			1 0 0			Rm							

```
d = UInt(Rd); m = UInt(Rm); setflags = (S == '1');
(-, shift_n) = DecodeImmShift('10', imm5);
```

Assembler syntax

ASR{S}<C><Q> {<Rd>}, <Rm>, #<imm>

where:

- S If S is present, the instruction updates the flags. Otherwise, the flags are not updated.
- <C><Q> See *Standard assembler syntax fields* on page A8-7.
- <Rd> The destination register. [↴](#)
- <Rm> The first operand register. [↴](#)
- <imm> The shift amount, in the range 1 to 32. See *Shifts applied to a register* on page A8-10.

Operation

```

if ConditionPassed() then
    EncodingSpecificOperations();
    (result, carry) = Shift_C(R[m], SRTYPE_ASR, shift_n, APSR.C);
    if d == 15 then // Can only occur for ARM encoding
        ALUWritePC(result); // setflags is always FALSE here
    else
        R[d] = result;
        if setflags then
            APSR.N = result<31>;
            APSR.Z = IsZeroBit(result);
            APSR.C = carry;
            // APSR.V unchanged

```

Exceptions

None.

A8.6.15 ASR (register)

Arithmetic Shift Right (register) shifts a register value right by a variable number of bits, shifting in copies of its sign bit, and writes the result to the destination register. The variable number of bits is read from the bottom byte of a register. It can optionally update the condition flags based on the result.

Encoding T1 ARMv4T, ARMv5T*, ARMv6*, ARMv7

ASRS <Rdn>, <Rm> Outside IT block.
 ASR<c> <Rdn>, <Rm> Inside IT block.

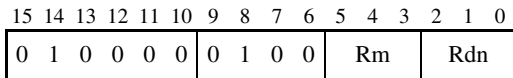

d = UInt(Rdn); n = UInt(Rdn); m = UInt(Rm); setflags = !InITBlock();

Encoding T2 ARMv6T2, ARMv7

ASR{S}<c>.W <Rd>, <Rn>, <Rm>

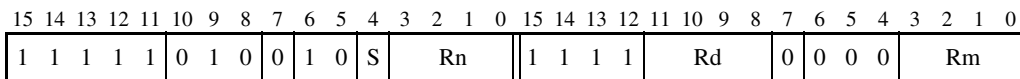

d = UInt(Rd); n = UInt(Rn); m = UInt(Rm); setflags = (S == '1');
 if BadReg(d) || BadReg(n) || BadReg(m) then UNPREDICTABLE;

Encoding A1 ARMv4*, ARMv5T*, ARMv6*, ARMv7

ASR{S}<c> <Rd>, <Rn>, <Rm>

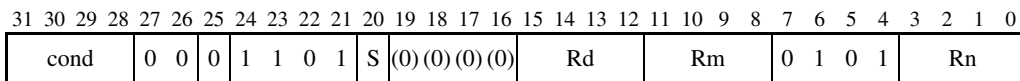

d = UInt(Rd); n = UInt(Rn); m = UInt(Rm); setflags = (S == '1');
 if d == 15 || n == 15 || m == 15 then UNPREDICTABLE;

Assembler syntax

```
ASR{S}<C><Q> {<Rd>,<Rn>,<Rm>
```

where:

- S If S is present, the instruction updates the flags. Otherwise, the flags are not updated.
- <C><Q> See *Standard assembler syntax fields* on page A8-7.
- <Rd> The destination register.
- <Rn> The first operand register.
- <Rm> The register whose bottom byte contains the amount to shift by.

Operation

```
if ConditionPassed() then
    EncodingSpecificOperations();
    shift_n = UInt(R[m]<7:0>);
    (result, carry) = Shift_C(R[n], SRTYPE_ASR, shift_n, APSR.C);
    R[d] = result;
    if setflags then
        APSR.N = result<31>;
        APSR.Z = IsZeroBit(result);
        APSR.C = carry;
        // APSR.V unchanged
```

Exceptions

None.

A8.6.16 B

Branch causes a branch to a target address.

Encoding T1 ARMv4T, ARMv5T*, ARMv6*, ARMv7

B<c> <label>

Not permitted in IT block.

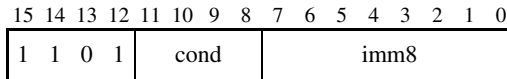

```
if cond == '1110' then UNDEFINED;
if cond == '1111' then SEE SVC;
imm32 = SignExtend(imm8:'0', 32);
if InITBlock() then UNPREDICTABLE;
```

Encoding T2 ARMv4T, ARMv5T*, ARMv6*, ARMv7

B<c> <label>

Outside or last in IT block

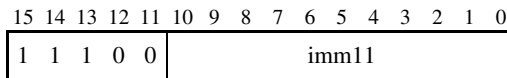

```
imm32 = SignExtend(imm11:'0', 32);
if InITBlock() && !LastInITBlock() then UNPREDICTABLE;
```

Encoding T3 ARMv6T2, ARMv7

B<c>.W <label>

Not permitted in IT block.

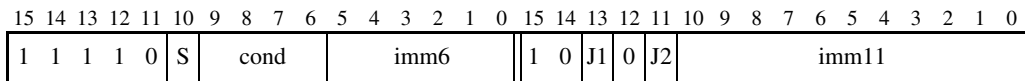

```
if cond<3:1> == '111' then SEE "Related encodings";
imm32 = SignExtend(S:J2:J1:imm6:imm11:'0', 32);
if InITBlock() then UNPREDICTABLE;
```

Encoding T4 ARMv6T2, ARMv7

B<c>.W <label>

Outside or last in IT block

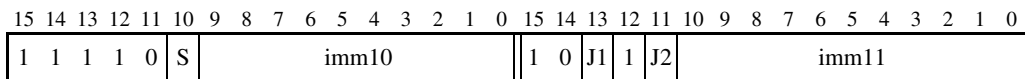

```
I1 = NOT(J1 EOR S); I2 = NOT(J2 EOR S); imm32 = SignExtend(S:I1:I2:imm10:imm11:'0', 32);
if InITBlock() && !LastInITBlock() then UNPREDICTABLE;
```

Encoding A1 ARMv4*, ARMv5T*, ARMv6*, ARMv7

B<c> <label>

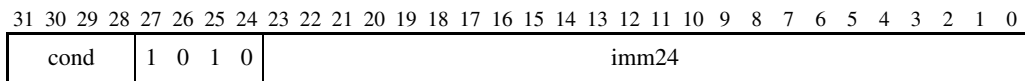

```
imm32 = SignExtend(imm24:'00', 32);
```

Related encodings See *Branches and miscellaneous control* on page A6-20

Assembler syntax

B<c><q> <label>

where:

<c><q> See *Standard assembler syntax fields* on page A8-7.

————— Note —————

Encodings T1 and T3 are conditional in their own right, and do not require an IT instruction to make them conditional.

For encodings T1 and T3, <c> must not be AL or omitted. The 4-bit encoding of the condition is placed in the instruction and not in a preceding IT instruction, and the instruction must not be in an IT block. As a result, encodings T1 and T2 are never both available to the assembler, nor are encodings T3 and T4.

<label> The label of the instruction that is to be branched to. The assembler calculates the required value of the offset from the PC value of the B instruction to this label, then selects an encoding that sets imm32 to that offset.

Permitted offsets are:

Encoding T1	Even numbers in the range –256 to 254
Encoding T2	Even numbers in the range –2048 to 2046
Encoding T3	Even numbers in the range –1048576 to 1048574
Encoding T4	Even numbers in the range –16777216 to 16777214
Encoding A1	Multiples of 4 in the range –33554432 to 33554428.

Operation

```
if ConditionPassed() then
    EncodingSpecificOperations();
    BranchWritePC(PC + imm32);
```

Exceptions

None.

A8.6.17 BFC

Bit Field Clear clears any number of adjacent bits at any position in a register, without affecting the other bits in the register.

Encoding T1 ARMv6T2, ARMv7

BFC<c> <Rd>, #<lsb>, #<width>

15	14	13	12	11	10	9	8	7	6	5	4	3	2	1	0	15	14	13	12	11	10	9	8	7	6	5	4	3	2	1	0
1	1	1	1	0	(0)	1	1	0	1	1	0	1	1	1	1	0	imm3	Rd	imm2	(0)	msb										

```
d = UInt(Rd); msbit = UInt(msb); lsbbit = UInt(imm3:imm2);
if BadReg(d) then UNPREDICTABLE;
```

Encoding A1 ARMv6T2, ARMv7

BFC<c> <Rd>, #<lsb>, #<width>

31	30	29	28	27	26	25	24	23	22	21	20	19	18	17	16	15	14	13	12	11	10	9	8	7	6	5	4	3	2	1	0
cond		0	1	1	1	1	1	0	msb								Rd	lsb			0	0	1	1 1 1 1							

```
d = UInt(Rd); msbit = UInt(msb); lsbbit = UInt(lsb);
if d == 15 then UNPREDICTABLE;
```

Assembler syntax

BFC<c><q> <Rd>, #<lsb>, #<width>

where:

<c><q> See *Standard assembler syntax fields* on page A8-7.

<Rd> The destination register.

<lsb> The least significant bit that is to be cleared, in the range 0 to 31. This determines the required value of `lsbit`.

<width> The number of bits to be cleared, in the range 1 to 32-<lsb>. The required value of `msbit` is <lsb>+<width>-1.

Operation

```
if ConditionPassed() then
    EncodingSpecificOperations();
    if msbit >= lsbit then
        R[d]<msbit:lsbit> = Replicate('0', msbit-lsbit+1);
        // Other bits of R[d] are unchanged
    else
        UNPREDICTABLE;
```

Exceptions

None.

A8.6.18 BFI

Bit Field Insert copies any number of low order bits from a register into the same number of adjacent bits at any position in the destination register.

Encoding T1 ARMv6T2, ARMv7

BFI<c> <Rd>, <Rn>, #<lsb>, #<width>

15	14	13	12	11	10	9	8	7	6	5	4	3	2	1	0	15	14	13	12	11	10	9	8	7	6	5	4	3	2	1	0
1	1	1	1	0	(0)	1	1	0	1	1	0	Rn				0	imm3			Rd			imm2	(0)	msb						

```
if Rn == '1111' then SEE BFC;
d = UInt(Rd); n = UInt(Rn); msbit = UInt(msb); lsbbit = UInt(imm3:imm2);
if BadReg(d) || n == 13 then UNPREDICTABLE;
```

Encoding A1 ARMv6T2, ARMv7

BFI<c> <Rd>, <Rn>, #<lsb>, #<width>

31	30	29	28	27	26	25	24	23	22	21	20	19	18	17	16	15	14	13	12	11	10	9	8	7	6	5	4	3	2	1	0
cond		0	1	1	1	1	1	0	msb				Rd			lsb			0	0	1	Rn									

```
if Rn == '1111' then SEE BFC;
d = UInt(Rd); n = UInt(Rn); msbit = UInt(msb); lsbbit = UInt(lsb);
if d == 15 then UNPREDICTABLE;
```

Assembler syntax

BFI<c><q> <Rd>, <Rn>, #<lsb>, #<width>

where:

<c><q>	See <i>Standard assembler syntax fields</i> on page A8-7.
<Rd>	The destination register.
<Rn>	The source register.
<lsb>	The least significant destination bit, in the range 0 to 31. This determines the required value of <i>lsbit</i> .
<width>	The number of bits to be copied, in the range 1 to 32-<lsb>. The required value of <i>msbit</i> is <lsb>+<width>-1.

Operation

```

if ConditionPassed() then
    EncodingSpecificOperations();
    if msbit >= lsbit then
        R[d]<msbit:lsbit> = R[n]<(msbit-lsbit):0>;
        // Other bits of R[d] are unchanged
    else
        UNPREDICTABLE;

```

Exceptions

None.

A8.6.19 BIC (immediate)

Bitwise Bit Clear (immediate) performs a bitwise AND of a register value and the complement of an immediate value, and writes the result to the destination register. It can optionally update the condition flags based on the result.

Encoding T1 ARMv6T2, ARMv7

BIC{S}<c> <Rd>, <Rn>, #<const>

15	14	13	12	11	10	9	8	7	6	5	4	3	2	1	0	15	14	13	12	11	10	9	8	7	6	5	4	3	2	1	0
1	1	1	1	0	i	0	0	0	0	1	S	Rn				0	imm3			Rd			imm8								

```
d = UInt(Rd); n = UInt(Rn); setflags = (S == '1');
(imm32, carry) = ThumbExpandImm_C(i:imm3:imm8, APSR.C);
if BadReg(d) || BadReg(n) then UNPREDICTABLE;
```

Encoding A1 ARMv4*, ARMv5T*, ARMv6*, ARMv7

BIC{S}<c> <Rd>, <Rn>, #<const>

31	30	29	28	27	26	25	24	23	22	21	20	19	18	17	16	15	14	13	12	11	10	9	8	7	6	5	4	3	2	1	0
cond		0	0	1	1	1	1	0	S	Rn				Rd				imm12													

```
if Rd == '1111' && S == '1' then SEE SUBS PC, LR and related instructions;
d = UInt(Rd); n = UInt(Rn); setflags = (S == '1');
(imm32, carry) = ARMEExpandImm_C(imm12, APSR.C);
```

Assembler syntax

BIC{S}<c><q> {<Rd>}, <Rn>, #<const>

where:

S If S is present, the instruction updates the flags. Otherwise, the flags are not updated.

<c><q> See *Standard assembler syntax fields* on page A8-7.

<Rd> The destination register [1](#).

<Rn> The register that contains the operand [1](#).

<const> The immediate value to be bitwise inverted and ANDed with the value obtained from <Rn>. See *Modified immediate constants in Thumb instructions* on page A6-17 or *Modified immediate constants in ARM instructions* on page A5-9 for the range of values.

The pre-UAL syntax BIC<c>S is equivalent to BICS<c>.

Operation

```

if ConditionPassed() then
    EncodingSpecificOperations();
    result = R[n] AND NOT(imm32);
    if d == 15 then // Can only occur for ARM encoding
        ALUWritePC(result); // setflags is always FALSE here
    else
        R[d] = result;
        if setflags then
            APSR.N = result<31>;
            APSR.Z = IsZeroBit(result);
            APSR.C = carry;
            // APSR.V unchanged

```

Exceptions

None.

A8.6.20 BIC (register)

Bitwise Bit Clear (register) performs a bitwise AND of a register value and the complement of an optionally-shifted register value, and writes the result to the destination register. It can optionally update the condition flags based on the result.

Encoding T1 ARMv4T, ARMv5T*, ARMv6*, ARMv7

BICS <Rdn>, <Rm> Outside IT block.
 BIC<c> <Rdn>, <Rm> Inside IT block.

15	14	13	12	11	10	9	8	7	6	5	4	3	2	1	0
0	1	0	0	0	0	1	1	1	0	Rm	Rdn				

```
d = UInt(Rdn); n = UInt(Rdn); m = UInt(Rm); setflags = !InITBlock();
(shift_t, shift_n) = (SRTYPE_LSL, 0);
```

Encoding T2 ARMv6T2, ARMv7

BIC{S}<c>.W <Rd>, <Rn>, <Rm>{, <shift>}

15	14	13	12	11	10	9	8	7	6	5	4	3	2	1	0	15	14	13	12	11	10	9	8	7	6	5	4	3	2	1	0
1	1	1	0	1	0	1	0	0	0	1	S	Rn	(0)	imm3	Rd	imm2	type	Rm													

```
d = UInt(Rd); n = UInt(Rn); m = UInt(Rm); setflags = (S == '1');
(shift_t, shift_n) = DecodeImmShift(type, imm3:imm2);
if BadReg(d) || BadReg(n) || BadReg(m) then UNPREDICTABLE;
```

Encoding A1 ARMv4*, ARMv5T*, ARMv6*, ARMv7

BIC{S}<c> <Rd>, <Rn>, <Rm>{, <shift>}

31	30	29	28	27	26	25	24	23	22	21	20	19	18	17	16	15	14	13	12	11	10	9	8	7	6	5	4	3	2	1	0
cond			0	0	0	1	1	1	0	S	Rn	Rd	imm5			type	0	Rm													

```
if Rd == '1111' && S == '1' then SEE SUBS PC, LR and related instructions;
d = UInt(Rd); n = UInt(Rn); m = UInt(Rm); setflags = (S == '1');
(shift_t, shift_n) = DecodeImmShift(type, imm5);
```

Assembler syntax

BIC{S}<C><Q> {<Rd>}, <Rn>, <Rm> {,<shift>}

where:

S	If S is present, the instruction updates the flags. Otherwise, the flags are not updated.
<C><Q>	See <i>Standard assembler syntax fields</i> on page A8-7.
<Rd>	The destination register ↓
<Rn>	The first operand register ↓
<Rm>	The register that is optionally shifted and used as the second operand ↓
<shift>	The shift to apply to the value read from <Rm>. If present, encoding T1 is not permitted. If absent, no shift is applied and all encodings are permitted. <i>Shifts applied to a register</i> on page A8-10 describes the shifts and how they are encoded.

The pre-UAL syntax BIC<C>S is equivalent to BICS<C>.

Operation

```

if ConditionPassed() then
    EncodingSpecificOperations();
    (shifted, carry) = Shift_C(R[m], shift_t, shift_n, APSR.C);
    result = R[n] AND NOT(shifted);
    if d == 15 then // Can only occur for ARM encoding
        ALUWritePC(result); // setflags is always FALSE here
    else
        R[d] = result;
        if setflags then
            APSR.N = result<31>;
            APSR.Z = IsZeroBit(result);
            APSR.C = carry;
            // APSR.V unchanged

```

Exceptions

None.

A8.6.21 BIC (register-shifted register)

Bitwise Bit Clear (register-shifted register) performs a bitwise AND of a register value and the complement of a register-shifted register value. It writes the result to the destination register, and can optionally update the condition flags based on the result.

Encoding A1 ARMv4*, ARMv5T*, ARMv6*, ARMv7

BIC{S}<C> <Rd>, <Rn>, <Rm>, <type> <Rs>

31	30	29	28	27	26	25	24	23	22	21	20	19	18	17	16	15	14	13	12	11	10	9	8	7	6	5	4	3	2	1	0
cond			0	0	0	1	1	1	0	S	Rn				Rd				Rs		0	type		1	Rm						

```
d = UInt(Rd); n = UInt(Rn); m = UInt(Rm); s = UInt(Rs);
setflags = (S == '1'); shift_t = DecodeRegShift(type);
if d == 15 || n == 15 || m == 15 || s == 15 then UNPREDICTABLE;
```

Assembler syntax

BIC{S}<C><Q> {<Rd>}, <Rn>, <Rm>, <type> <Rs>

where:

S	If S is present, the instruction updates the flags. Otherwise, the flags are not updated.								
<C><Q>	See <i>Standard assembler syntax fields</i> on page A8-7.								
<Rd>	The destination register.								
<Rn>	The first operand register.								
<Rm>	The register that is shifted and used as the second operand.								
<type>	The type of shift to apply to the value read from <Rm>. It must be one of: <table> <tr> <td>ASR</td> <td>Arithmetic shift right, encoded as type = 0b10</td> </tr> <tr> <td>LSL</td> <td>Logical shift left, encoded as type = 0b00</td> </tr> <tr> <td>LSR</td> <td>Logical shift right, encoded as type = 0b01</td> </tr> <tr> <td>ROR</td> <td>Rotate right, encoded as type = 0b11.</td> </tr> </table>	ASR	Arithmetic shift right, encoded as type = 0b10	LSL	Logical shift left, encoded as type = 0b00	LSR	Logical shift right, encoded as type = 0b01	ROR	Rotate right, encoded as type = 0b11.
ASR	Arithmetic shift right, encoded as type = 0b10								
LSL	Logical shift left, encoded as type = 0b00								
LSR	Logical shift right, encoded as type = 0b01								
ROR	Rotate right, encoded as type = 0b11.								
<Rs>	The register whose bottom byte contains the amount to shift by.								

The pre-UAL syntax BIC<C>S is equivalent to BICS<C>.

Operation

```

if ConditionPassed() then
    EncodingSpecificOperations();
    shift_n = UInt(R[s]<7:0>);
    (shifted, carry) = Shift_C(R[m], shift_t, shift_n, APSR.C);
    result = R[n] AND NOT(shifted);
    R[d] = result;
    if setflags then
        APSR.N = result<31>;
        APSR.Z = IsZeroBit(result);
        APSR.C = carry;
        // APSR.V unchanged
  
```

Exceptions

None.

A8.6.22 BKPT

Breakpoint causes a software breakpoint to occur.

Breakpoint is always unconditional, even when inside an IT block.

Encoding T1 ARMv5T*, ARMv6*, ARMv7

BKPT #<imm8>

15	14	13	12	11	10	9	8	7	6	5	4	3	2	1	0
1	0	1	1	1	1	1	0	imm8							

```
imm32 = ZeroExtend(imm8, 32);
// imm32 is for assembly/disassembly only and is ignored by hardware.
```

Encoding A1 ARMv5T*, ARMv6*, ARMv7

BKPT #<imm16>

31	30	29	28	27	26	25	24	23	22	21	20	19	18	17	16	15	14	13	12	11	10	9	8	7	6	5	4	3	2	1	0
cond		0 0 0 1 0 0 1 0						imm12								0 1 1 1				imm4											

```
imm32 = ZeroExtend(imm12:imm4, 32);
// imm32 is for assembly/disassembly only and is ignored by hardware.
```

```
if cond != '1110' then UNPREDICTABLE; // BKPT must be encoded with AL condition
```

Assembler syntax

BKPT<q> #<imm>

where:

- <q> See *Standard assembler syntax fields* on page A8-7. A BKPT instruction must be unconditional.
- <imm> Specifies a value that is stored in the instruction, in the range 0-255 for a Thumb instruction or 0-65535 for an ARM instruction. This value is ignored by the processor, but can be used by a debugger to store more information about the breakpoint.

Operation

EncodingSpecificOperations();
BKPTInstrDebugEvent();

Exceptions

Prefetch Abort.

A8.6.23 BL, BLX (immediate)

Branch with Link calls a subroutine at a PC-relative address.

Branch with Link and Exchange Instruction Sets (immediate) calls a subroutine at a PC-relative address, and changes instruction set from ARM to Thumb, or from Thumb to ARM.

Encoding T1 ARMv4T, ARMv5T*, ARMv6*, ARMv7 if J1 == J2 == 1
ARMv6T2, ARMv7 otherwise

BL<c> <label> Outside or last in IT block

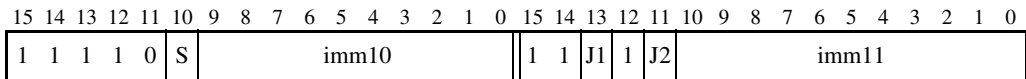

```
I1 = NOT(J1 EOR S); I2 = NOT(J2 EOR S); imm32 = SignExtend(S:I1:I2:imm10:imm11:'0', 32);
toARM = FALSE;
if InITBlock() && !LastInITBlock() then UNPREDICTABLE;
```

Encoding T2 ARMv5T*, ARMv6*, ARMv7 if J1 == J2 == 1
ARMv6T2, ARMv7 otherwise

BLX<c> <label> Outside or last in IT block

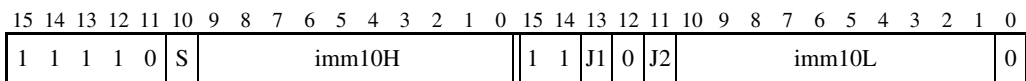

```
if CurrentInstrSet() == InstrSet_ThumbEE then UNDEFINED;
I1 = NOT(J1 EOR S); I2 = NOT(J2 EOR S); imm32 = SignExtend(S:I1:I2:imm10H:imm10L:'00', 32);
toARM = TRUE;
if InITBlock() && !LastInITBlock() then UNPREDICTABLE;
```

Encoding A1 ARMv4*, ARMv5T*, ARMv6*, ARMv7

BL<c> <label>

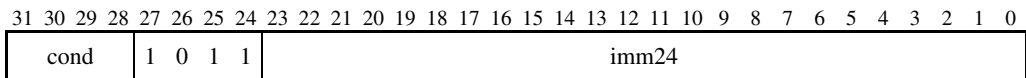

```
imm32 = SignExtend(imm24:'00', 32); toARM = TRUE;
```

Encoding A2 ARMv5T*, ARMv6*, ARMv7

BLX <label>

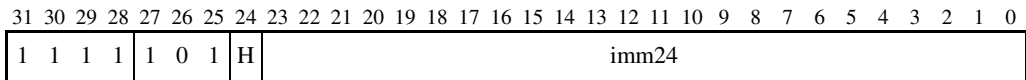

```
imm32 = SignExtend(imm24:H:'0', 32); toARM = FALSE;
```

Assembler syntax

BL{X}<c><q> <label>

where:

- <c><q> See *Standard assembler syntax fields* on page A8-7. An ARM BLX (immediate) instruction must be unconditional.
- X If present, specifies a change of instruction set (from ARM to Thumb or from Thumb to ARM). If X is omitted, the processor remains in the same state. For ThumbEE code, specifying X is not permitted.
- <label> The label of the instruction that is to be branched to.
- For BL (encodings T1, A1), the assembler calculates the required value of the offset from the PC value of the BL instruction to this label, then selects an encoding that sets imm32 to that offset. Permitted offsets are even numbers in the range -16777216 to 16777214 (Thumb) or multiples of 4 in the range -33554432 to 33554428 (ARM).
- For BLX (encodings T2, A2), the assembler calculates the required value of the offset from the $\text{Align}(\text{PC}, 4)$ value of the BLX instruction to this label, then selects an encoding that sets imm32 to that offset. Permitted offsets are multiples of 4 in the range -16777216 to 16777212 (Thumb) or even numbers in the range -33554432 to 33554430 (ARM).

Operation

```

if ConditionPassed() then
    EncodingSpecificOperations();
    if CurrentInstrSet == InstrSet_ARM then
        next_instr_addr = PC - 4;
        LR = next_instr_addr;
    else
        next_instr_addr = PC;
        LR = next_instr_addr <31:1> : '1';
    if toARM then
        SelectInstrSet(InstrSet_ARM);
        BranchWritePC(Align(PC, 4) + imm32);
    else
        SelectInstrSet(InstrSet_Thumb);
        BranchWritePC(PC + imm32);

```



Exceptions

None.

Branch range before ARMv6T2

Before ARMv6T2, J1 and J2 in encodings T1 and T2 were both 1, resulting in a smaller branch range. The instructions could be executed as two separate 16-bit instructions, as described in *BL and BLX (immediate) instructions, before ARMv6T2* on page AppxG-4.

A8.6.24 BLX (register)

Branch with Link and Exchange (register) calls a subroutine at an address and instruction set specified by a register.

Encoding T1 ARMv5T*, ARMv6*, ARMv7

BLX<C> <Rm>

Outside or last in IT block

15	14	13	12	11	10	9	8	7	6	5	4	3	2	1	0
0	1	0	0	0	1	1	1	1	Rm	(0)	(0)	(0)			

```
m = UInt(Rm);
if m == 15 then UNPREDICTABLE;
if InITBlock() && !LastInITBlock() then UNPREDICTABLE;
```

Encoding A1 ARMv5T*, ARMv6*, ARMv7

BLX<C> <Rm>

31	30	29	28	27	26	25	24	23	22	21	20	19	18	17	16	15	14	13	12	11	10	9	8	7	6	5	4	3	2	1	0	
cond	0	0	0	1	0	0	1	0	(1)	(1)	(1)	(1)	(1)	(1)	(1)	(1)	(1)	(1)	(1)	(1)	(1)	0	0	1	1	Rm						

```
m = UInt(Rm);
if m == 15 then UNPREDICTABLE;
```

Assembler syntax

BLX<c><q> <Rm>

where:

<c><q> See *Standard assembler syntax fields* on page A8-7.

<Rm> The register that contains the branch target address and instruction set selection bit.

Operation

```

if ConditionPassed() then
    EncodingSpecificOperations();
    if CurrentInstrSet() == InstrSet_ARM then
        next_instr_addr = PC - 4;
        LR = next_instr_addr;
    else
        next_instr_addr = PC - 2;
        LR = next_instr_addr<31:1> : '1';
    BXWritePC(R<Rm>);

```

Exceptions

None.

A8.6.25 BX

Branch and Exchange causes a branch to an address and instruction set specified by a register.

Encoding T1 ARMv4T, ARMv5T*, ARMv6*, ARMv7

BX<c> <Rm> Outside or last in IT block

15	14	13	12	11	10	9	8	7	6	5	4	3	2	1	0
0	1	0	0	0	1	1	1	0	Rm				(0)	(0)	(0)

m = UInt(Rm);
 if InITBlock() && !LastInITBlock() then UNPREDICTABLE;

Encoding A1 ARMv4T, ARMv5T*, ARMv6*, ARMv7

BX<c> Rm

31	30	29	28	27	26	25	24	23	22	21	20	19	18	17	16	15	14	13	12	11	10	9	8	7	6	5	4	3	2	1	0
cond		0	0	0	1	0	0	1	0	(1)	(1)	(1)	(1)	(1)	(1)	(1)	(1)	(1)	(1)	(1)	(1)	(1)	(1)	(1)	0	0	0	1	Rm		

m = UInt(Rm);

Assembler syntax

BX<c><q> <Rm>

where:

<c><q> See *Standard assembler syntax fields* on page A8-7.

<Rm> The register that contains the branch target address and instruction set selection bit. The PC can be used.

Note

If <Rm> is the PC in a Thumb instruction at a non word-aligned address, it results in UNPREDICTABLE behavior because the address passed to the BXWritePC() pseudocode function has bits<1:0> = '10'.

Operation

```
if ConditionPassed() then
    EncodingSpecificOperations();
    BXWritePC(R[m]);
```

Exceptions

None.

A8.6.26 BXJ

Branch and Exchange Jazelle attempts to change to Jazelle state. If the attempt fails, it branches to an address and instruction set specified by a register as though it were a BX instruction.

Encoding T1 ARMv6T2, ARMv7

BXJ<C> <Rm>

Outside or last in IT block

15	14	13	12	11	10	9	8	7	6	5	4	3	2	1	0	15	14	13	12	11	10	9	8	7	6	5	4	3	2	1	0
1	1	1	1	0	0	1	1	1	1	0	0	Rm			1	0	(0)	0	(1)	(1)	(1)	(1)	(0)	(0)	(0)	(0)	(0)	(0)	(0)	(0)	

```
m = UInt(Rm);
if BadReg(m) then UNPREDICTABLE;
if InITBlock() && !LastInITBlock() then UNPREDICTABLE;
```

Encoding A1 ARMv5TEJ, ARMv6*, ARMv7

BXJ<C> <Rm>

31	30	29	28	27	26	25	24	23	22	21	20	19	18	17	16	15	14	13	12	11	10	9	8	7	6	5	4	3	2	1	0
cond		0	0	0	1	0	0	1	0	(1)	(1)	(1)	(1)	(1)	(1)	(1)	(1)	(1)	(1)	(1)	(1)	(1)	(1)	0	0	1	0	Rm			

```
m = UInt(Rm);
if m == 15 then UNPREDICTABLE;
```

Assembler syntax

BXJ<C><q> <Rm>

where:

<C><q> See *Standard assembler syntax fields* on page A8-7.

<Rm> The register that specifies the branch target address and instruction set selection bit to be used if the attempt to switch to Jazelle state fails.

Operation

```

if ConditionPassed() then
    EncodingSpecificOperations();
    if JMCR.JE == '0' || CurrentInstrSet() == InstrSet_ThumbEE then
        BXWritePC(R[m]);
    else
        if JazelleAcceptsExecution() then
            SwitchToJazelleExecution();
        else
            SUBARCHITECTURE_DEFINED handler call;

```

Exceptions

None.

A8.6.27 CBNZ, CBZ

Compare and Branch on Nonzero and Compare and Branch on Zero compare the value in a register with zero, and conditionally branch forward a constant value. They do not affect the condition flags.

Encoding T1 ARMv6T2, ARMv7

CB{N}Z <Rn>, <label>

Not permitted in IT block.

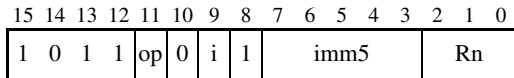

```
n = UInt(Rn); imm32 = ZeroExtend(i:imm5:'0', 32); nonzero = (op == '1');
if InITBlock() then UNPREDICTABLE;
```

Assembler syntax

CB{N}Z<q> <Rn>, <label>

where:

N	If specified, causes the branch to occur when the contents of <Rn> are nonzero (encoded as op = 1). If omitted, causes the branch to occur when the contents of <Rn> are zero (encoded as op = 0).
<q>	See <i>Standard assembler syntax fields</i> on page A8-7. A CBZ or CBNZ instruction must be unconditional.
<Rn>	The operand register.
<label>	The label of the instruction that is to be branched to. The assembler calculates the required value of the offset from the PC value of the CB{N}Z instruction to this label, then selects an encoding that sets imm32 to that offset. Permitted offsets are even numbers in the range 0 to 126.

Operation

```
EncodingSpecificOperations();
if nonzero ^ IsZero(R[n]) then
    BranchWritePC(PC + imm32);
```

Exceptions

None.

A8.6.28 CDP, CDP2

Coprocessor Data Processing tells a coprocessor to perform an operation that is independent of ARM core registers and memory. If no coprocessor can execute the instruction, an Undefined Instruction exception is generated.

This is a generic coprocessor instruction. Some of the fields have no functionality defined by the architecture and are free for use by the coprocessor instruction set designer. These fields are the `opc1`, `opc2`, `CRd`, `CRn`, and `CRm` fields.

For more information about the coprocessors see *Coprocessor support* on page A2-68.

Encoding T1 / A1 ARMv6T2, ARMv7 for encoding T1
 ARMv4*, ARMv5T*, ARMv6*, ARMv7 for encoding A1

CDP<c> <coproc>, <opc1>, <CRd>, <CRn>, <CRm>, <opc2>

15	14	13	12	11	10	9	8	7	6	5	4	3	2	1	0	15	14	13	12	11	10	9	8	7	6	5	4	3	2	1	0									
1	1	1	0	1	1	1	0	opc1				CRn				CRd				coproc		opc2		0	CRm															
31	30	29	28	27	26	25	24	23	22	21	20	19	18	17	16	15	14	13	12	11	10	9	8	7	6	5	4	3	2	1	0									
cond				1				1				1				0				opc1				CRn				CRd				coproc		opc2		0	CRm			

if coproc == '101x' then SEE "VFP instructions";
 cp = UInt(coproc);

Encoding T2 / A2 ARMv6T2, ARMv7 for encoding T2
 ARMv5T*, ARMv6*, ARMv7 for encoding [A2](#)

CDP2<c> <coproc>, <opc1>, <CRd>, <CRn>, <CRm>, <opc2>

15	14	13	12	11	10	9	8	7	6	5	4	3	2	1	0	15	14	13	12	11	10	9	8	7	6	5	4	3	2	1	0													
1	1	1	1	1	1	1	0	opc1				CRn				CRd				coproc		opc2		0	CRm																			
31	30	29	28	27	26	25	24	23	22	21	20	19	18	17	16	15	14	13	12	11	10	9	8	7	6	5	4	3	2	1	0													
1				1				1				1				1				0				opc1				CRn				CRd				coproc		opc2		0	CRm			

cp = UInt(coproc);

VFP instructions See *VFP data-processing instructions* on page A7-24

Assembler syntax

CDP{2}<c><q> <coproc>, #<opc1>, <CRd>, <CRn>, <CRm> {, #<opc2>}

where:

2	If specified, selects encoding T2 / A2. If omitted, selects encoding T1 / A1.
<c><q>	See <i>Standard assembler syntax fields</i> on page A8-7. An ARM CDP2 instruction must be unconditional.
<coproc>	The name of the coprocessor, and causes the corresponding coprocessor number to be placed in the cp_num field of the instruction. The standard generic coprocessor names are p0, p1, ..., p15.
<opc1>	Is a coprocessor-specific opcode, in the range 0 to 15.
<CRd>	The destination coprocessor register for the instruction.
<CRn>	The coprocessor register that contains the first operand.
<CRm>	The coprocessor register that contains the second operand.
<opc2>	Is a coprocessor-specific opcode in the range 0 to 7. If it is omitted, <opc2> is 0.

Operation

```

if ConditionPassed() then
    EncodingSpecificOperations();
    if !Cproc_Accepted(cp, ThisInstr()) then
        GenerateCoproprocessorException();
    else
        Cproc_InternalOperation(cp, ThisInstr());

```

Exceptions

Undefined Instruction.

A8.6.29 CHKA

CHKA is a ThumbEE instruction. For details see *CHKA* on page A9-15.

A8.6.30 CLREX

Clear-Exclusive clears the local record of the executing processor that an address has had a request for an exclusive access.

Encoding T1 ARMv7

CLREX<C>

15	14	13	12	11	10	9	8	7	6	5	4	3	2	1	0	15	14	13	12	11	10	9	8	7	6	5	4	3	2	1	0
1	1	1	1	0	0	1	1	1	0	1	1	(1)	(1)	(1)	(1)	1	0	(0)	0	(1)	(1)	(1)	(1)	0	0	1	0	(1)	(1)	(1)	(1)

// No additional decoding required

Encoding A1 ARMv6K, ARMv7

CLREX

31	30	29	28	27	26	25	24	23	22	21	20	19	18	17	16	15	14	13	12	11	10	9	8	7	6	5	4	3	2	1	0	
1	1	1	1	0	1	0	1	0	1	1	1	(1)	(1)	(1)	(1)	(1)	(1)	(1)	(1)	(1)	(0)	(0)	(0)	(0)	0	0	0	1	(1)	(1)	(1)	(1)

// No additional decoding required

Assembler syntax

CLREX<c><q>

where:

<c><q> See *Standard assembler syntax fields* on page A8-7. An ARM CLREX instruction must be unconditional.

Operation

```
if ConditionPassed() then
    EncodingSpecificOperations();
    ClearExclusiveLocal(ProcessorID());
```

Exceptions

None.

A8.6.31 CLZ

Count Leading Zeros returns the number of binary zero bits before the first binary one bit in a value.

Encoding T1 ARMv6T2, ARMv7

CLZ<c> <Rd>, <Rm>

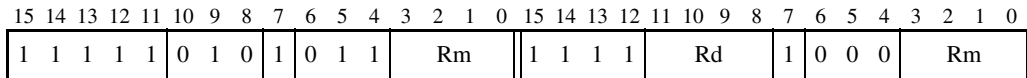

```

if !Consistent(Rm) then UNPREDICTABLE;
d = UInt(Rd); m = UInt(Rm);
if BadReg(d) || BadReg(m) then UNPREDICTABLE;
    
```

Encoding A1 ARMv5T*, ARMv6*, ARMv7

CLZ<c> <Rd>, <Rm>

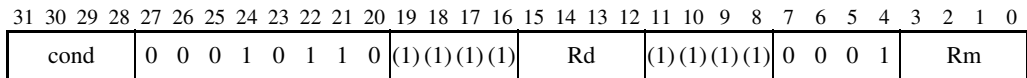

```

d = UInt(Rd); m = UInt(Rm);
if d == 15 || m == 15 then UNPREDICTABLE;
    
```

Assembler syntax

CLZ<c><q> <Rd>, <Rm>

where:

<c><q> See *Standard assembler syntax fields* on page A8-7.

<Rd> The destination register.

<Rm> The register that contains the operand. Its number must be encoded twice in encoding T1.

Operation

```
if ConditionPassed() then
    EncodingSpecificOperations();
    result = CountLeadingZeroBits(R[m]);
    R[d] = result<31:0>;
```

Exceptions

None.

A8.6.32 CMN (immediate)

Compare Negative (immediate) adds a register value and an immediate value. It updates the condition flags based on the result, and discards the result.

Encoding T1 ARMv6T2, ARMv7

CMN<c> <Rn>, #<const>

15	14	13	12	11	10	9	8	7	6	5	4	3	2	1	0	15	14	13	12	11	10	9	8	7	6	5	4	3	2	1	0
1	1	1	1	0	i	0	1	0	0	0	1	Rn				0	imm3			1	1	1	1	imm8							

n = UInt(Rn); imm32 = ThumbExpandImm(i:imm3:imm8);
 if n == 15 then UNPREDICTABLE;

Encoding A1 ARMv4*, ARMv5T*, ARMv6*, ARMv7

CMN<c> <Rn>, #<const>

31	30	29	28	27	26	25	24	23	22	21	20	19	18	17	16	15	14	13	12	11	10	9	8	7	6	5	4	3	2	1	0
cond		0	0	1	1	0	1	1	1	Rn				(0)	(0)	(0)	(0)	imm12													

n = UInt(Rn); imm32 = ARMEExpandImm(imm12);

Assembler syntax

CMN<c><q> <Rn>, #<const>

where:

<c><q> See *Standard assembler syntax fields* on page A8-7.

<Rn> The register that contains the operand. SP can be used in Thumb as well as in ARM [↓](#)

<const> The immediate value to be added to the value obtained from <Rn>. See *Modified immediate constants in Thumb instructions* on page A6-17 or *Modified immediate constants in ARM instructions* on page A5-9 for the range of values.

Operation

```
if ConditionPassed() then
    EncodingSpecificOperations();
    (result, carry, overflow) = AddWithCarry(R[n], imm32, '0');
    APSR.N = result<31>;
    APSR.Z = IsZeroBit(result);
    APSR.C = carry;
    APSR.V = overflow;
```

Exceptions

None.

A8.6.33 CMN (register)

Compare Negative (register) adds a register value and an optionally-shifted register value. It updates the condition flags based on the result, and discards the result.

Encoding T1 ARMv4T, ARMv5T*, ARMv6*, ARMv7

CMN<c> <Rn>, <Rm>

15	14	13	12	11	10	9	8	7	6	5	4	3	2	1	0
0	1	0	0	0	0	1	0	1	1	Rm			Rn		

n = UInt(Rn); m = UInt(Rm);
 (shift_t, shift_n) = (SRTYPE_LSL, 0);

Encoding T2 ARMv6T2, ARMv7

CMN<c>.W <Rn>, <Rm>{, <shift>}

15	14	13	12	11	10	9	8	7	6	5	4	3	2	1	0	15	14	13	12	11	10	9	8	7	6	5	4	3	2	1	0
1	1	1	0	1	0	1	1	0	0	0	1	Rn			(0)	imm3			1	1	1	1	imm2		type	Rm					

n = UInt(Rn); m = UInt(Rm);
 (shift_t, shift_n) = DecodeImmShift(type, imm3:imm2);
 if n == 15 || BadReg(m) then UNPREDICTABLE;

Encoding A1 ARMv4*, ARMv5T*, ARMv6*, ARMv7

CMN<c> <Rn>, <Rm>{, <shift>}

31	30	29	28	27	26	25	24	23	22	21	20	19	18	17	16	15	14	13	12	11	10	9	8	7	6	5	4	3	2	1	0
cond		0	0	0	1	0	1	1	1	Rn			(0)	(0)	(0)	(0)	imm5			type	0	Rm									

n = UInt(Rn); m = UInt(Rm);
 (shift_t, shift_n) = DecodeImmShift(type, imm5);

Assembler syntax

CMN<c><q> <Rn>, <Rm> {,<shift>}

where:

<c><q> See *Standard assembler syntax fields* on page A8-7.

<Rn> The first operand register. SP can be used in Thumb (encoding T2) as well as in ARM [1](#).

<Rm> The register that is optionally shifted and used as the second operand [1](#).

<shift> The shift to apply to the value read from <Rm>. If present, encoding T1 is not permitted. If absent, no shift is applied and all encodings are permitted. *Shifts applied to a register* on page A8-10 describes the shifts and how they are encoded.

Operation

```
if ConditionPassed() then
    EncodingSpecificOperations();
    shifted = Shift(R[m], shift_t, shift_n, APSR.C);
    (result, carry, overflow) = AddWithCarry(R[n], shifted, '0');
    APSR.N = result<31>;
    APSR.Z = IsZeroBit(result);
    APSR.C = carry;
    APSR.V = overflow;
```

Exceptions

None.

A8.6.34 CMN (register-shifted register)

Compare Negative (register-shifted register) adds a register value and a register-shifted register value. It updates the condition flags based on the result, and discards the result.

Encoding A1 ARMv4*, ARMv5T*, ARMv6*, ARMv7

CMN<c> <Rn>, <Rm>, <type> <Rs>

31	30	29	28	27	26	25	24	23	22	21	20	19	18	17	16	15	14	13	12	11	10	9	8	7	6	5	4	3	2	1	0
cond	0	0	0	1	0	1	1	1	Rn				(0)	(0)	(0)	(0)	Rs		0	type	1	Rm									

```
n = UInt(Rn); m = UInt(Rm); s = UInt(Rs);
shift_t = DecodeRegShift(type);
if n == 15 || m == 15 || s == 15 then UNPREDICTABLE;
```

Assembler syntax

CMN<c><q> <Rn>, <Rm>, <type> <Rs>

where:

<c><q>	See <i>Standard assembler syntax fields</i> on page A8-7.
<Rn>	The first operand register.
<Rm>	The register that is shifted and used as the second operand.
<type>	The type of shift to apply to the value read from <Rm>. It must be one of: <ul style="list-style-type: none"> ASR Arithmetic shift right, encoded as type = 0b10 LSL Logical shift left, encoded as type = 0b00 LSR Logical shift right, encoded as type = 0b01 ROR Rotate right, encoded as type = 0b11.
<Rs>	The register whose bottom byte contains the amount to shift by.

Operation

```

if ConditionPassed() then
    EncodingSpecificOperations();
    shift_n = UInt(R[s]<7:0>);
    shifted = Shift(R[m], shift_t, shift_n, APSR.C);
    (result, carry, overflow) = AddWithCarry(R[n], shifted, '0');
    APSR.N = result<31>;
    APSR.Z = IsZeroBit(result);
    APSR.C = carry;
    APSR.V = overflow;
  
```

Exceptions

None.

A8.6.35 CMP (immediate)

Compare (immediate) subtracts an immediate value from a register value. It updates the condition flags based on the result, and discards the result.

Encoding T1 ARMv4T, ARMv5T*, ARMv6*, ARMv7

CMP<c> <Rn>, #<imm8>

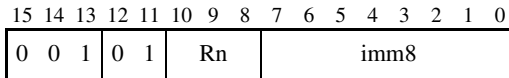

n = UInt(Rdn); imm32 = ZeroExtend(imm8, 32);

Encoding T2 ARMv6T2, ARMv7

CMP<c>.W <Rn>, #<const>

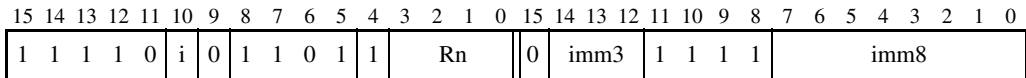

n = UInt(Rn); imm32 = ThumbExpandImm(i:imm3:imm8);
if n == 15 then UNPREDICTABLE;

Encoding A1 ARMv4*, ARMv5T*, ARMv6*, ARMv7

CMP<c> <Rn>, #<const>

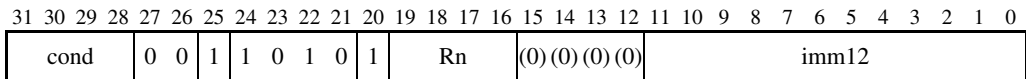

n = UInt(Rn); imm32 = ARMEExpandImm(imm12);

Assembler syntax

CMP<c><q> <Rn>, #<const>

where:

<c><q> See *Standard assembler syntax fields* on page A8-7.

<Rn> The first operand register. SP can be used in Thumb (encoding T2) as well as in ARM [1](#).

<const> The immediate value to be compared with the value obtained from <Rn>. The range of values is 0-255 for encoding T1. See *Modified immediate constants in Thumb instructions* on page A6-17 or *Modified immediate constants in ARM instructions* on page A5-9 for the range of values for encoding T2 and A1.

Operation

```
if ConditionPassed() then
    EncodingSpecificOperations();
    (result, carry, overflow) = AddWithCarry(R[n], NOT(imm32), '1');
    APSR.N = result<31>;
    APSR.Z = IsZeroBit(result);
    APSR.C = carry;
    APSR.V = overflow;
```

Exceptions

None.

A8.6.36 CMP (register)

Compare (register) subtracts an optionally-shifted register value from a register value. It updates the condition flags based on the result, and discards the result.

Encoding T1 ARMv4T, ARMv5T*, ARMv6*, ARMv7

CMP<c> <Rn>, <Rm> <Rn> and <Rm> both from R0-R7

15	14	13	12	11	10	9	8	7	6	5	4	3	2	1	0
0	1	0	0	0	0	1	0	1	0	Rm			Rn		

n = UInt(Rn); m = UInt(Rm);
 (shift_t, shift_n) = (SRTYPE_LSL, 0);

Encoding T2 ARMv4T, ARMv5T*, ARMv6*, ARMv7

CMP<c> <Rn>, <Rm> <Rn> and <Rm> not both from R0-R7

15	14	13	12	11	10	9	8	7	6	5	4	3	2	1	0
0	1	0	0	0	1	0	1	N	Rm			Rn			

n = UInt(N:Rn); m = UInt(Rm);
 (shift_t, shift_n) = (SRTYPE_LSL, 0);
 if n < 8 && m < 8 then UNPREDICTABLE;
 if n == 15 || m == 15 then UNPREDICTABLE;

Encoding T3 ARMv6T2, ARMv7

CMP<c>.W <Rn>, <Rm> {,<shift>}

15	14	13	12	11	10	9	8	7	6	5	4	3	2	1	0	15	14	13	12	11	10	9	8	7	6	5	4	3	2	1	0
1	1	1	0	1	0	1	1	1	0	1	1	Rn			(0)	imm3			1	1	1	1	imm2		type	Rm					

n = UInt(Rn); m = UInt(Rm);
 (shift_t, shift_n) = DecodeImmShift(type, imm3:imm2);
 if n == 15 || BadReg(m) then UNPREDICTABLE;

Encoding A1 ARMv4*, ARMv5T*, ARMv6*, ARMv7

CMP<c> <Rn>, <Rm> {,<shift>}

31	30	29	28	27	26	25	24	23	22	21	20	19	18	17	16	15	14	13	12	11	10	9	8	7	6	5	4	3	2	1	0
cond		0	0	0	1	0	1	0	1	0	1	Rn			(0)	(0)	(0)	(0)	imm5			type	0	Rm							

n = UInt(Rn); m = UInt(Rm);
 (shift_t, shift_n) = DecodeImmShift(type, imm5);

Assembler syntax

CMP<c><q> <Rn>, <Rm> {,<shift>}

where:

<c><q> See *Standard assembler syntax fields* on page A8-7.

<Rn> The first operand register. The SP can be used.

<Rm> The register that is optionally shifted and used as the second operand. This register can be SP in both ARM and Thumb instructions, but:

- the use of SP is deprecated
- when assembling for the Thumb instruction set, only encoding T2 is available.

<shift> The shift to apply to the value read from <Rm>. If present, encodings T1 and T2 are not permitted. If absent, no shift is applied and all encodings are permitted. *Shifts applied to a register* on page A8-10 describes the shifts and how they are encoded.

Operation

```
if ConditionPassed() then
    EncodingSpecificOperations();
    shifted = Shift(R[m], shift_t, shift_n, APSR.C);
    (result, carry, overflow) = AddWithCarry(R[n], NOT(shifted), '1');
    APSR.N = result<31>;
    APSR.Z = IsZeroBit(result);
    APSR.C = carry;
    APSR.V = overflow;
```

Exceptions

None.

A8.6.37 CMP (register-shifted register)

Compare (register-shifted register) subtracts a register-shifted register value from a register value. It updates the condition flags based on the result, and discards the result.

Encoding A1 ARMv4*, ARMv5T*, ARMv6*, ARMv7

CMP<c> <Rn>, <Rm>, <type> <Rs>

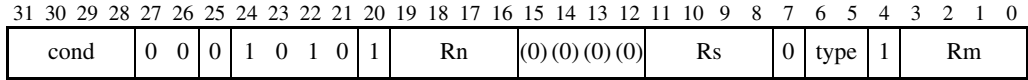

```
n = UInt(Rn); m = UInt(Rm); s = UInt(Rs);
shift_t = DecodeRegShift(type);
if n == 15 || m == 15 || s == 15 then UNPREDICTABLE;
```

Assembler syntax

CMP<c><q> <Rn>, <Rm>, <type> <Rs>

where:

<c><q>	See <i>Standard assembler syntax fields</i> on page A8-7.
<Rn>	The first operand register.
<Rm>	The register that is shifted and used as the second operand.
<type>	The type of shift to apply to the value read from <Rm>. It must be one of: <ul style="list-style-type: none"> ASR Arithmetic shift right, encoded as type = 0b10 LSL Logical shift left, encoded as type = 0b00 LSR Logical shift right, encoded as type = 0b01 ROR Rotate right, encoded as type = 0b11.
<Rs>	The register whose bottom byte contains the amount to shift by.

Operation

```

if ConditionPassed() then
    EncodingSpecificOperations();
    shift_n = UInt(R[s]<7:0>);
    shifted = Shift(R[m], shift_t, shift_n, APSR.C);
    (result, carry, overflow) = AddWithCarry(R[n], NOT(shifted), '1');
    APSR.N = result<31>;
    APSR.Z = IsZeroBit(result);
    APSR.C = carry;
    APSR.V = overflow;

```

Exceptions

None.

A8.6.38 CPS

Change Processor State is a system instruction. For details see *CPS* on page B6-3.

A8.6.39 CPY

Copy is a pre-UAL synonym for MOV (register).

Assembler syntax

CPY <Rd>, <Rn>

This is equivalent to:

MOV <Rd>, <Rn>

Exceptions

None.

A8.6.40 DBG

Debug Hint provides a hint to debug and related systems. See their documentation for what use (if any) they make of this instruction.

Encoding T1 ARMv7 (executes as NOP in ARMv6T2)

DBG<c> #<option>

15	14	13	12	11	10	9	8	7	6	5	4	3	2	1	0	15	14	13	12	11	10	9	8	7	6	5	4	3	2	1	0
1	1	1	1	0	0	1	1	1	0	1	0	(1)	(1)	(1)	(1)	(1)	1	0	(0)	0	(0)	0	0	0	1	1	1	1	option		

// Any decoding of 'option' is specified by the debug system

Encoding A1 ARMv7 (executes as NOP in ARMv6K and ARMv6T2)

DBG<c> #<option>

31	30	29	28	27	26	25	24	23	22	21	20	19	18	17	16	15	14	13	12	11	10	9	8	7	6	5	4	3	2	1	0
cond	0	0	1	1	0	0	1	0	0	0	0	0	(1)	(1)	(1)	(1)	(1)	(0)	(0)	(0)	(0)	(0)	1	1	1	1	option				

// Any decoding of 'option' is specified by the debug system

Assembler syntax

DBG<c><q> #<option>

where:

<c><q> See *Standard assembler syntax fields* on page A8-7.

<option> Provides extra information about the hint, and is in the range 0 to 15.

Operation

```
if ConditionPassed() then
    EncodingSpecificOperations();
    Hint_Debug(option);
```

Exceptions

None.

A8.6.41 DMB

Data Memory Barrier is a memory barrier that ensures the ordering of observations of memory accesses, see *Data Memory Barrier (DMB)* on page A3-48.

Encoding T1 ARMv7

DMB<c> #<option>

15	14	13	12	11	10	9	8	7	6	5	4	3	2	1	0	15	14	13	12	11	10	9	8	7	6	5	4	3	2	1	0
1	1	1	1	0	0	1	1	1	0	1	1	(1)	(1)	(1)	(1)	1	0	(0)	0	(1)	(1)	(1)	(1)	0	1	0	1	option			

// No additional decoding required

Encoding A1 ARMv7

DMB #<option>

31	30	29	28	27	26	25	24	23	22	21	20	19	18	17	16	15	14	13	12	11	10	9	8	7	6	5	4	3	2	1	0
1	1	1	1	0	1	0	1	0	1	1	1	(1)	(1)	(1)	(1)	(1)	(1)	(1)	(1)	(1)	(0)	(0)	(0)	(0)	0	1	0	1	option		

// No additional decoding required

Assembler syntax

DMB<c><q> {<opt>}

where:

<c><q> See *Standard assembler syntax fields* on page A8-7. An ARM DMB instruction must be unconditional.

<opt> Specifies an optional limitation on the DMB operation. Values are:

SY	Full system is the required shareability domain, reads and writes are the required access types. Can be omitted. This option is referred to as the full system DMB. Encoded as option == '1111'.
ST	Full system is the required shareability domain, writes are the required access type. SYST is a synonym for ST. Encoded as option == '1110'.
ISH	Inner Shareable is the required shareability domain, reads and writes are the required access types. Encoded as option == '1011'.
ISHST	Inner Shareable is the required shareability domain, writes are the required access type. Encoded as option == '1010'.
NSH	Non-shareable is the required shareability domain, reads and writes are the required access types. Encoded as option == '0111'.
NSHST	Non-shareable is the required shareability domain, writes are the required access type. Encoded as option == '0110'.



OSH Outer Shareable is the required shareability domain, reads and writes are the required access types. Encoded as option == '0011'.

OSHST Outer Shareable is the required shareability domain, writes are the required access type. Encoded as option == '0010'.

All other encodings of option are reserved. It is IMPLEMENTATION DEFINED whether options other than SY are implemented. All unsupported and reserved options must execute as a full system DMB operation, but software must not ~~must~~ rely on this ~~operation~~.



Note

The following alternative <opt> values are supported, but ARM recommends that you do not use these alternative values:

- SH as an alias for ISH
- SHST as an alias for ISHST
- UN as an alias for NSH
- UNST is an alias for NSHST.

Operation

```

if ConditionPassed() then
    EncodingSpecificOperations();
    case option of
        when '0010' domain = MBReqDomain_OuterShareable; types = MBReqTypes_Writes;
        when '0010' domain = MBReqDomain_OuterShareable; types = MBReqTypes_All;
        when '0110' domain = MBReqDomain_Nonshareable; types = MBReqTypes_Writes;
        when '0111' domain = MBReqDomain_Nonshareable; types = MBReqTypes_All;
        when '1010' domain = MBReqDomain_InnerShareable; types = MBReqTypes_Writes;
        when '1011' domain = MBReqDomain_InnerShareable; types = MBReqTypes_All;
        when '1110' domain = MBReqDomain_FullSystem; types = MBReqTypes_Writes;
        otherwise domain = MBReqDomain_FullSystem; types = MBReqTypes_All;
    DataMemoryBarrier(domain, types);

```

Exceptions

None.

A8.6.42 DSB

Data Synchronization Barrier is a memory barrier that ensures the completion of memory accesses, see *Data Synchronization Barrier (DSB)* on page A3-49.

Encoding T1 ARMv7

DSB<c> #<option>

15	14	13	12	11	10	9	8	7	6	5	4	3	2	1	0	15	14	13	12	11	10	9	8	7	6	5	4	3	2	1	0
1	1	1	1	0	0	1	1	1	0	1	1	(1)	(1)	(1)	(1)	1	0	(0)	0	(1)	(1)	(1)	(1)	0	1	0	0	option			

// No additional decoding required

Encoding A1 ARMv7

DSB #<option>

31	30	29	28	27	26	25	24	23	22	21	20	19	18	17	16	15	14	13	12	11	10	9	8	7	6	5	4	3	2	1	0
1	1	1	1	0	1	0	1	0	1	1	1	(1)	(1)	(1)	(1)	(1)	(1)	(1)	(1)	(1)	(0)	(0)	(0)	(0)	0	1	0	0	option		

// No additional decoding required

Assembler syntax

DSB<c><q> {<opt>}

where:

<c><q> See *Standard assembler syntax fields* on page A8-7. An ARM DSB instruction must be unconditional.

<opt> Specifies an optional limitation on the DSB operation. Values are:

SY	Full system is the required shareability domain, reads and writes are the required access types. Can be omitted. This option is referred to as the full system DMB . Encoded as option == '1111'.
ST	Full system is the required shareability domain, writes are the required access type. SYST is a synonym for ST. Encoded as option == '1110'.
ISH	Inner Shareable is the required shareability domain, reads and writes are the required access types. Encoded as option == '1011'.
ISHST	Inner Shareable is the required shareability domain, writes are the required access type. Encoded as option == '1010'.
NSH	Non-shareable is the required shareability domain, reads and writes are the required access types. Encoded as option == '0111'.
NSHST	Non-shareable is the required shareability domain, writes are the required access type. Encoded as option == '0110'.

- OSH Outer Shareable is the required shareability domain, reads and writes are the required access types. Encoded as option == '0011'.
- OSHST Outer Shareable is the required shareability domain, writes are the required access type. Encoded as option == '0010'.

All other encodings of option are reserved. It is IMPLEMENTATION DEFINED whether options other than SY are implemented. All unsupported and reserved options must execute as a full system DSB operation, but software must not ~~must~~ rely on this ~~operation~~.



Note

The following alternative <opt> values are supported, but ARM recommends that you do not use these alternative values:

- SH as an alias for ISH
- SHST as an alias for ISHST
- UN as an alias for NSH
- UNST is an alias for NSHST.

Operation

```
if ConditionPassed() then
    EncodingSpecificOperations();
    case option of
        when '0010' domain = MBReqDomain_OuterShareable; types = MBReqTypes_Writes;
        when '0010' domain = MBReqDomain_OuterShareable; types = MBReqTypes_All;
        when '0110' domain = MBReqDomain_Nonshareable; types = MBReqTypes_Writes;
        when '0111' domain = MBReqDomain_Nonshareable; types = MBReqTypes_All;
        when '1010' domain = MBReqDomain_InnerShareable; types = MBReqTypes_Writes;
        when '1011' domain = MBReqDomain_InnerShareable; types = MBReqTypes_All;
        when '1110' domain = MBReqDomain_FullSystem; types = MBReqTypes_Writes;
        otherwise domain = MBReqDomain_FullSystem; types = MBReqTypes_All;
    DataSynchronizationBarrier(domain, types);
```

Exceptions

None.

A8.6.43 ENTERX

ENTERX causes a change from Thumb state to ThumbEE state, or has no effect in ThumbEE state. For details see *ENTERX*, *LEAVEX* on page A9-7.

A8.6.44 EOR (immediate)

Bitwise Exclusive OR (immediate) performs a bitwise Exclusive OR of a register value and an immediate value, and writes the result to the destination register. It can optionally update the condition flags based on the result.

Encoding T1 ARMv6T2, ARMv7

EOR{S}<C> <Rd>, <Rn>, #<const>

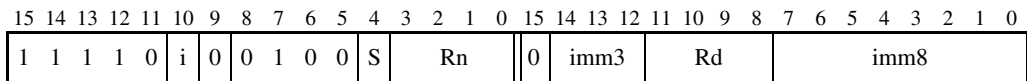

```

if Rd == '1111' && S == '1' then SEE TEQ (immediate);
d = UInt(Rd); n = UInt(Rn); setflags = (S == '1');
(imm32, carry) = ThumbExpandImm_C(i:imm3:imm8, APSR.C);
if BadReg(d) || BadReg(n) then UNPREDICTABLE;
    
```

Encoding A1 ARMv4*, ARMv5T*, ARMv6*, ARMv7

EOR{S}<C> <Rd>, <Rn>, #<const>

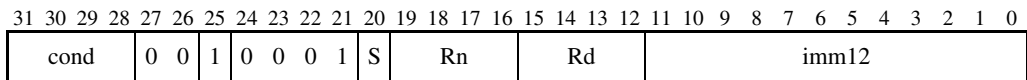

```

if Rd == '1111' && S == '1' then SEE SUBS PC, LR and related instructions;
d = UInt(Rd); n = UInt(Rn); setflags = (S == '1');
(imm32, carry) = ARMEExpandImm_C(imm12, APSR.C);
    
```

Assembler syntax

EOR{S}<C><Q> {<Rd>}, <Rn>, #<const>

where:

- S If S is present, the instruction updates the flags. Otherwise, the flags are not updated.
- <C><Q> See *Standard assembler syntax fields* on page A8-7.
- <Rd> The destination register [1](#).
- <Rn> The register that contains the operand [1](#).
- <const> The immediate value to be exclusive ORed with the value obtained from <Rn>. See *Modified immediate constants in Thumb instructions* on page A6-17 or *Modified immediate constants in ARM instructions* on page A5-9 for the range of values.

The pre-UAL syntax EOR<C>S is equivalent to EORS<C>.

Operation

```

if ConditionPassed() then
    EncodingSpecificOperations();
    result = R[n] EOR imm32;
    if d == 15 then // Can only occur for ARM encoding
        ALUWritePC(result); // setflags is always FALSE here
    else
        R[d] = result;
        if setflags then
            APSR.N = result<31>;
            APSR.Z = IsZeroBit(result);
            APSR.C = carry;
            // APSR.V unchanged

```

Exceptions

None.

A8.6.45 EOR (register)

Bitwise Exclusive OR (register) performs a bitwise Exclusive OR of a register value and an optionally-shifted register value, and writes the result to the destination register. It can optionally update the condition flags based on the result.

Encoding T1 ARMv4T, ARMv5T*, ARMv6*, ARMv7

EORS <Rdn>, <Rm> Outside IT block.
 EOR<c> <Rdn>, <Rm> Inside IT block.

15	14	13	12	11	10	9	8	7	6	5	4	3	2	1	0
0	1	0	0	0	0	0	0	0	1	Rm				Rdn	

d = UInt(Rdn); n = UInt(Rdn); m = UInt(Rm); setflags = !InITBlock();
 (shift_t, shift_n) = (SRTYPE_LSL, 0);

Encoding T2 ARMv6T2, ARMv7

EOR{S}<c>.W <Rd>, <Rn>, <Rm>{, <shift>}

15	14	13	12	11	10	9	8	7	6	5	4	3	2	1	0	15	14	13	12	11	10	9	8	7	6	5	4	3	2	1	0
1	1	1	0	1	0	1	0	1	0	0	S	Rn			(0)	imm3		Rd		imm2		type		Rm							

if Rd == '1111' && S == '1' then SEE TEQ (register);
 d = UInt(Rd); n = UInt(Rn); m = UInt(Rm); setflags = (S == '1');
 (shift_t, shift_n) = DecodeImmShift(type, imm3:imm2);
 if BadReg(d) || BadReg(n) || BadReg(m) then UNPREDICTABLE;

Encoding A1 ARMv4*, ARMv5T*, ARMv6*, ARMv7

EOR{S}<c> <Rd>, <Rn>, <Rm>{, <shift>}

31	30	29	28	27	26	25	24	23	22	21	20	19	18	17	16	15	14	13	12	11	10	9	8	7	6	5	4	3	2	1	0
cond		0	0	0	0	0	0	1	S	Rn			Rd			imm5		type		0	Rm										

if Rd == '1111' && S == '1' then SEE SUBS PC, LR and related instructions;
 d = UInt(Rd); n = UInt(Rn); m = UInt(Rm); setflags = (S == '1');
 (shift_t, shift_n) = DecodeImmShift(type, imm5);

Assembler syntax

EOR{S}<C><Q> {<Rd>}, <Rn>, <Rm> {,<shift>}

where:

S	If S is present, the instruction updates the flags. Otherwise, the flags are not updated.
<C><Q>	See <i>Standard assembler syntax fields</i> on page A8-7.
<Rd>	The destination register. ↴
<Rn>	The first operand register. ↴
<Rm>	The register that is optionally shifted and used as the second operand. ↴
<shift>	The shift to apply to the value read from <Rm>. If present, encoding T1 is not permitted. If absent, no shift is applied and all encodings are permitted. <i>Shifts applied to a register</i> on page A8-10 describes the shifts and how they are encoded.

In Thumb assembly:

- outside an IT block, if EORS <Rd>, <Rn>, <Rd> has <Rd> and <Rn> both in the range R0-R7, it is assembled using encoding T1 as though EORS <Rd>, <Rn> had been written
- inside an IT block, if EOR<C> <Rd>, <Rn>, <Rd> has <Rd> and <Rn> both in the range R0-R7, it is assembled using encoding T1 as though EOR<C> <Rd>, <Rn> had been written.

To prevent either of these happening, use the .W qualifier.

The pre-UAL syntax EOR<C>S is equivalent to EORS<C>.

Operation

```

if ConditionPassed() then
    EncodingSpecificOperations();
    (shifted, carry) = Shift_C(R[m], shift_t, shift_n, APSR.C);
    result = R[n] EOR shifted;
    if d == 15 then // Can only occur for ARM encoding
        ALUWritePC(result); // setflags is always FALSE here
    else
        R[d] = result;
        if setflags then
            APSR.N = result<31>;
            APSR.Z = IsZeroBit(result);
            APSR.C = carry;
            // APSR.V unchanged

```

Exceptions

None.

A8.6.46 EOR (register-shifted register)

Bitwise Exclusive OR (register-shifted register) performs a bitwise Exclusive OR of a register value and a register-shifted register value. It writes the result to the destination register, and can optionally update the condition flags based on the result.

Encoding A1 ARMv4*, ARMv5T*, ARMv6*, ARMv7

EOR{S}<C> <Rd>, <Rn>, <Rm>, <type> <Rs>

31	30	29	28	27	26	25	24	23	22	21	20	19	18	17	16	15	14	13	12	11	10	9	8	7	6	5	4	3	2	1	0
cond			0	0	0	0	0	0	1	S	Rn				Rd				Rs		0	type		1	Rm						

```
d = UInt(Rd); n = UInt(Rn); m = UInt(Rm); s = UInt(Rs);
setflags = (S == '1'); shift_t = DecodeRegShift(type);
if d == 15 || n == 15 || m == 15 || s == 15 then UNPREDICTABLE;
```

Assembler syntax

EOR{S}<C><Q> {<Rd>}, <Rn>, <Rm>, <type> <Rs>

where:

S	If S is present, the instruction updates the flags. Otherwise, the flags are not updated.								
<C><Q>	See <i>Standard assembler syntax fields</i> on page A8-7.								
<Rd>	The destination register.								
<Rn>	The first operand register.								
<Rm>	The register that is shifted and used as the second operand.								
<type>	The type of shift to apply to the value read from <Rm>. It must be one of: <table> <tr> <td>ASR</td> <td>Arithmetic shift right, encoded as type = 0b10</td> </tr> <tr> <td>LSL</td> <td>Logical shift left, encoded as type = 0b00</td> </tr> <tr> <td>LSR</td> <td>Logical shift right, encoded as type = 0b01</td> </tr> <tr> <td>ROR</td> <td>Rotate right, encoded as type = 0b11.</td> </tr> </table>	ASR	Arithmetic shift right, encoded as type = 0b10	LSL	Logical shift left, encoded as type = 0b00	LSR	Logical shift right, encoded as type = 0b01	ROR	Rotate right, encoded as type = 0b11.
ASR	Arithmetic shift right, encoded as type = 0b10								
LSL	Logical shift left, encoded as type = 0b00								
LSR	Logical shift right, encoded as type = 0b01								
ROR	Rotate right, encoded as type = 0b11.								
<Rs>	The register whose bottom byte contains the amount to shift by.								

The pre-UAL syntax EOR<C>S is equivalent to EORS<C>.

Operation

```

if ConditionPassed() then
    EncodingSpecificOperations();
    shift_n = UInt(R[s]<7:0>);
    (shifted, carry) = Shift_C(R[m], shift_t, shift_n, APSR.C);
    result = R[n] EOR shifted;
    R[d] = result;
    if setflags then
        APSR.N = result<31>;
        APSR.Z = IsZeroBit(result);
        APSR.C = carry;
        // APSR.V unchanged
  
```

Exceptions

None.

A8.6.47 F* (former VFP instruction mnemonics)

Table A8-2 lists the UAL equivalents of pre-UAL VFP instruction mnemonics.

Table A8-2 VFP instruction mnemonics

Former ARM assembler mnemonic	UAL equivalent	See
FABSD, FABSS	VABS	<i>VABS</i> on page A8-532
FADD, FADDS	VADD	<i>VADD (floating-point)</i> on page A8-538
FCMP, FCMPE, FCMPEZ, FCMPEZ	VCMP{E}	<i>VCMP, VCMPE</i> on page A8-572
FCONSTD, FCONSTS	VMOV	<i>VMOV (immediate)</i> on page A8-640
FCPYD, FCPYS	VMOV	<i>VMOV (register)</i> on page A8-642
FCVTDS, FCVTSD	VCVT	<i>VCVT (between double-precision and single-precision)</i> on page A8-584
FDIVD, FDIVS	VDIV	<i>VDIV</i> on page A8-590
FLDD	VLDR	<i>VLDR</i> on page A8-628
FLDMD, FLDMS	VLDM, VPOP	<i>VLDM</i> on page A8-626. <i>VPOP</i> on page A8-694
FLDMX	FLDMX	<i>FLDMX, FSTMX</i> on page A8-101
FLDS	VLDR	<i>VLDR</i> on page A8-628
FMACD, FMACS	VMLA	<i>VMLA, VMLS (floating-point)</i> on page A8-636
FMDHR, FMDLR	VMOV	<i>VMOV (ARM core register to scalar)</i> on page A8-644
FMDRR	VMOV	<i>VMOV (between two ARM core registers and a doubleword extension register)</i> on page A8-652
FMRDH, FMRDL	VMOV	<i>VMOV (scalar to ARM core register)</i> on page A8-646
FMRRD	VMOV	<i>VMOV (between two ARM core registers and a doubleword extension register)</i> on page A8-652
FMRRS	VMOV	<i>VMOV (between two ARM core registers and two single-precision registers)</i> on page A8-650
FMRS	VMOV	<i>VMOV (between ARM core register and single-precision register)</i> on page A8-648
FMRX	VMRS	<i>VMRS</i> on page A8-658
FMSCD, FMSCS	VNMLS	<i>VNMLA, VNMLS, VNMUL</i> on page A8-674
FMSR	VMOV	<i>VMOV (between ARM core register and single-precision register)</i> on page A8-648
FMSRR	VMOV	<i>VMOV (between two ARM core registers and two single-precision registers)</i> on page A8-650
FMSTAT	VMRS	<i>VMRS</i> on page A8-658
FMULD, FMULS	VMUL	<i>VMUL (floating-point)</i> on page A8-664
FMXR	VMSR	<i>VMSR</i> on page A8-660

Table A8-2 VFP instruction mnemonics (continued)

Former ARM assembler mnemonic	UAL equivalent	See
FNEGD, FNEGS	VNEG	<i>VNEG</i> on page A8-672
FNMACD, FNMACS	VMLS	<i>VMLA</i> , <i>VMLS</i> (floating-point) on page A8-636
FNMSCD, FNMSCS	VNMLA	<i>VNMLA</i> , <i>VNMLS</i> , <i>VNMUL</i> on page A8-674
FNMLD, FNMULS	VNMUL	<i>VNMLA</i> , <i>VNMLS</i> , <i>VNMUL</i> on page A8-674
FSHTOD, FSHTOS	VCVT	<i>VCVT</i> (between floating-point and fixed-point, VFP) on page A8-582
FSITOD, FSITOS	VCVT	<i>VCVT</i> , <i>VCVTR</i> (between floating-point and integer, VFP) on page A8-578
FSLTOD, FSLTOS	VCVT	<i>VCVT</i> (between floating-point and fixed-point, VFP) on page A8-582
FSQRTD, FSQRTS	VSQRT	<i>VSQRT</i> on page A8-762
FSTD	VSTR	<i>VSTR</i> on page A8-786
FSTMD, FSTMS	VSTM, VPUSH	<i>VSTM</i> on page A8-784, <i>VPUSH</i> on page A8-696
FSTMX	FSTMX	<i>FLDMX</i> , <i>FSTMX</i>
FSTS	VSTR	<i>VSTR</i> on page A8-786
FSUBD, FSUBS	VSUB	<i>VSUB</i> (floating-point) on page A8-790
FTOSH, FTOSHS	VCVT	<i>VCVT</i> (between floating-point and fixed-point, VFP) on page A8-582
FTOSI{Z}D, FTOSI{Z}S	VCVT{R}	<i>VCVT</i> , <i>VCVTR</i> (between floating-point and integer, VFP) on page A8-578
FTOSL, FTOUH	VCVT	<i>VCVT</i> (between floating-point and fixed-point, VFP) on page A8-582
FTOUI{Z}D, FTOUI{Z}S	VCVT{R}	<i>VCVT</i> , <i>VCVTR</i> (between floating-point and integer, VFP) on page A8-578
FTOULD, FTOULS, FUHTOD, FUHTOS	VCVT	<i>VCVT</i> (between floating-point and fixed-point, VFP) on page A8-582
FUITOD, FUITOS	VCVT	<i>VCVT</i> , <i>VCVTR</i> (between floating-point and integer, VFP) on page A8-578
FULTOD, FULTOS	VCVT	<i>VCVT</i> (between floating-point and fixed-point, VFP) on page A8-582

FLDMX, FSTMX

Encodings T1/A1 of the VLDM, VPOP, VPUSH, and VSTM instructions contain an imm8 field that is set to twice the number of doubleword registers to be transferred. Use of these encodings with an odd value in imm8 is deprecated, and there is no UAL syntax for them.

The pre-UAL mnemonics FLDMX and FSTMX result in the same instructions as FLDM (VLDM.64 or VPOP.64) and FSTMD (VSTM.64 or VPUSH.64) respectively, except that imm8 is equal to twice the number of doubleword registers plus one. Use of FLDMX and FSTMX is deprecated from ARMv6, except for disassembly purposes, and reassembly of disassembled code.

A8.6.48 HB, HBL, HBLP, HBP

These are ThumbEE instructions. For details see *HB*, *HBL* on page A9-16, *HBLP* on page A9-17, and *HBP* on page A9-18.

A8.6.49 ISB

Instruction Synchronization Barrier flushes the pipeline in the processor, so that all instructions following the ISB are fetched from cache or memory, after the instruction has been completed. It ensures that the effects of context altering operations, such as changing the ASID, or completed TLB maintenance operations, or branch predictor maintenance operations, as well as all changes to the CP15 registers, executed before the ISB instruction are visible to the instructions fetched after the ISB.

In addition, any branches that appear in program order after the ISB instruction are written into the branch prediction logic with the context that is visible after the ISB instruction. This is needed to ensure correct execution of the instruction stream.

Encoding T1 ARMv7

ISB<c> #<option>

15	14	13	12	11	10	9	8	7	6	5	4	3	2	1	0	15	14	13	12	11	10	9	8	7	6	5	4	3	2	1	0
1	1	1	1	0	0	1	1	1	0	1	1	(1)	(1)	(1)	(1)	1	0	(0)	0	(1)	(1)	(1)	(1)	0	1	1	0	option			

// No additional decoding required

Encoding A1 ARMv7

ISB #<option>

31	30	29	28	27	26	25	24	23	22	21	20	19	18	17	16	15	14	13	12	11	10	9	8	7	6	5	4	3	2	1	0
1	1	1	1	0	1	0	1	0	1	1	1	(1)	(1)	(1)	(1)	(1)	(1)	(1)	(1)	(1)	(0)	(0)	(0)	(0)	0	1	1	0	option		

// No additional decoding required

Assembler syntax

ISB<c><q> {<opt>}

where:

<c><q> See *Standard assembler syntax fields* on page A8-7. An ARM ISB instruction must be unconditional.

<opt> Specifies an optional limitation on the ISB operation. Values are:
 SY Full system ISB operation, encoded as option == '1111'. Can be omitted.
 All other encodings of option are reserved. The corresponding instructions execute as full system ISB operations, but must not be relied upon by software.

Operation

```
if ConditionPassed() then
    EncodingSpecificOperations();
    InstructionSynchronizationBarrier();
```

Exceptions

None.

A8.6.50 IT

If Then makes up to four following instructions (the *IT block*) conditional. The conditions for the instructions in the IT block can be the same, or some of them can be the inverse of others.

IT does not affect the condition code flags. ~~Branches to any instruction in the IT block are not permitted, apart from those performed by exception returns.~~



16-bit instructions in the IT block, other than CMP, CMN and TST, do not set the condition code flags. The AL condition can be specified to get this changed behavior without conditional execution.

See also *ITSTATE* on page A2-17, *Conditional instructions* on page A4-4, and *Conditional execution* on page A8-8.

Encoding T1 ARMv6T2, ARMv7

~~IT{x{y}{z}}~~ <firstcond>

Not permitted in IT block

15	14	13	12	11	10	9	8	7	6	5	4	3	2	1	0
1	0	1	1	1	1	1	1	firstcond				mask			

if mask == '0000' then SEE "Related encodings";
 if firstcond == '1111' then UNPREDICTABLE;
 if firstcond == '1110' && BitCount(mask) != 1 then UNPREDICTABLE;
 if InITBlock() then UNPREDICTABLE;

Related encodings See *If-Then, and hints* on page A6-12

Assembler syntax

~~IT{x{y}{z}}<q>~~ <firstcond>

where:

- <x> The condition for the second instruction in the IT block.
- <y> The condition for the third instruction in the IT block.
- <z> The condition for the fourth instruction in the IT block.
- <q> See *Standard assembler syntax fields* on page A8-7. An IT instruction must be unconditional.
- <firstcond> The condition for the first instruction in the IT block. See Table A8-1 on page A8-8 for the range of conditions available, and the encodings.

Each of <x>, <y>, and <z> can be either:

- T Then. The condition attached to the instruction is <firstcond>.
- E Else. The condition attached to the instruction is the inverse of <firstcond>. The condition code is the same as <firstcond>, except that the least significant bit is inverted. E must not be specified if <firstcond> is AL.

Table A8-3 shows how the values of <x>, <y>, and <z> determine the value of the mask field.

Table A8-3 Determination of mask^a field

<x>	<y>	<z>	mask[3]	mask[2]	mask[1]	mask[0]
Omitted	Omitted	Omitted	1	0	0	0
T	Omitted	Omitted	firstcond[0]	1	0	0
E	Omitted	Omitted	NOT firstcond[0]	1	0	0
T	T	Omitted	firstcond[0]	firstcond[0]	1	0
E	T	Omitted	NOT firstcond[0]	firstcond[0]	1	0
T	E	Omitted	firstcond[0]	NOT firstcond[0]	1	0
E	E	Omitted	NOT firstcond[0]	NOT firstcond[0]	1	0
T	T	T	firstcond[0]	firstcond[0]	firstcond[0]	1
E	T	T	NOT firstcond[0]	firstcond[0]	firstcond[0]	1
T	E	T	firstcond[0]	NOT firstcond[0]	firstcond[0]	1
E	E	T	NOT firstcond[0]	NOT firstcond[0]	firstcond[0]	1
T	T	E	firstcond[0]	firstcond[0]	NOT firstcond[0]	1
E	T	E	NOT firstcond[0]	firstcond[0]	NOT firstcond[0]	1
T	E	E	firstcond[0]	NOT firstcond[0]	NOT firstcond[0]	1
E	E	E	NOT firstcond[0]	NOT firstcond[0]	NOT firstcond[0]	1

a. Note that at least one bit is always 1 in mask.

The conditions specified in an IT instruction must match those specified in the syntax of the instructions in its IT block. When assembling to ARM code, assemblers check IT instruction syntax for validity but do not generate assembled instructions for them. See *Conditional instructions* on page A4-4.

Operation

```
EncodingSpecificOperations();
ITSTATE.IT<7:0> = firstcond:mask;
```

Exceptions

None.

A8.6.51 LDC, LDC2 (immediate)

Load Coprocessor loads memory data from a sequence of consecutive memory addresses to a coprocessor. If no coprocessor can execute the instruction, an Undefined Instruction exception is generated.

This is a generic coprocessor instruction. Some of the fields have no functionality defined by the architecture and are free for use by the coprocessor instruction set designer. These fields are the D bit, the CRd field, and in the Unindexed addressing mode only, the imm8 field.

For more information about the coprocessors see *Coprocessor support* on page A2-68.

Encoding T1 / A1 ARMv6T2, ARMv7 for encoding T1
 ARMv4*, ARMv5T*, ARMv6*, ARMv7 for encoding A1

LDC{L}<c> <coproc>, <CRd>, [<Rn>, #+/-<imm>]{!}

LDC{L}<c> <coproc>, <CRd>, [<Rn>], #+/-<imm>

LDC{L}<c> <coproc>, <CRd>, [<Rn>], <option>

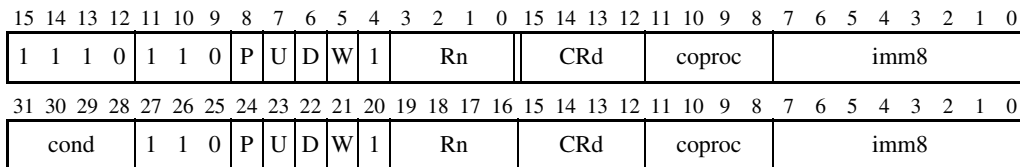

```

if Rn == '1111' then SEE LDC (literal);
if P == '0' && U == '0' && D == '0' && W == '0' then UNDEFINED;
if P == '0' && U == '0' && D == '1' && W == '0' then SEE MRRC, MRRC2;
if coproc == '101x' then SEE "Advanced SIMD and VFP";
n = UInt(Rn); cp = UInt(coproc); imm32 = ZeroExtend(imm8:'00', 32);
index = (P == '1'); add = (U == '1'); wback = (W == '1');
    
```

Encoding T2 / A2 ARMv6T2, ARMv7 for encoding T2
 ARMv5T*, ARMv6*, ARMv7 for encoding A2

LDC2{L}<c> <coproc>, <CRd>, [<Rn>, #+/-<imm>]{!}

LDC2{L}<c> <coproc>, <CRd>, [<Rn>], #+/-<imm>

LDC2{L}<c> <coproc>, <CRd>, [<Rn>], <option>

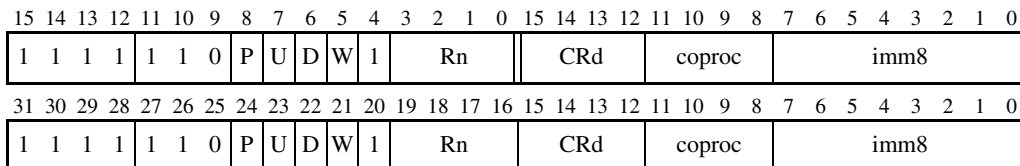

```

if Rn == '1111' then SEE LDC (literal);
if P == '0' && U == '0' && D == '0' && W == '0' then UNDEFINED;
if P == '0' && U == '0' && D == '1' && W == '0' then SEE MRRC, MRRC2;
n = UInt(Rn); cp = UInt(coproc); imm32 = ZeroExtend(imm8:'00', 32);
index = (P == '1'); add = (U == '1'); wback = (W == '1');
    
```

Advanced SIMD and VFP See *Extension register load/store instructions* on page A7-26

Assembler syntax

LDC{2}{L}<C><Q>	<coproc>, <CRd>, [<Rn>{, #+/-<imm>}]	Offset. P = 1, W = 0.
LDC{2}{L}<C><Q>	<coproc>, <CRd>, [<Rn>, #+/-<imm>!]	Pre-indexed. P = 1, W = 1.
LDC{2}{L}<C><Q>	<coproc>, <CRd>, [<Rn>], #+/-<imm>	Post-indexed. P = 0, W = 1.
LDC{2}{L}<C><Q>	<coproc>, <CRd>, [<Rn>], <option>	Unindexed. P = 0, W = 0, U = 1.

where:

2	If specified, selects encoding T2 / A2. If omitted, selects encoding T1 / A1.
L	If specified, selects the D == 1 form of the encoding. If omitted, selects the D == 0 form.
<C><Q>	See <i>Standard assembler syntax fields</i> on page A8-7. An ARM LDC2 instruction must be unconditional.
<coproc>	The name of the coprocessor. The standard generic coprocessor names are p0, p1, ..., p15.
<CRd>	The coprocessor destination register.
<Rn>	The base register. The SP can be used. For PC use see <i>LDC, LDC2 (literal)</i> on page A8-108.
+/-	Is + or omitted if the immediate offset is to be added to the base register value (add == TRUE), or – if it is to be subtracted (add == FALSE). #0 and #-0 generate different instructions.
<imm>	The immediate offset used to form the address. Values are multiples of 4 in the range 0-1020. For the offset addressing syntax, <imm> can be omitted, meaning an offset of +0.
<option>	A coprocessor option. An integer in the range 0-255 enclosed in { }. Encoded in imm8.

The pre-UAL syntax LDC<C>L is equivalent to LDCL<C>.

Operation

```

if ConditionPassed() then
    EncodingSpecificOperations();
    if !Coprocc_Accepted(cp, ThisInstr()) then
        GenerateCoproccorException();
    else
        NullCheckIfThumbEE(n);
        offset_addr = if add then (R[n] + imm32) else (R[n] - imm32);
        address = if index then offset_addr else R[n];
        repeat
            Coproc_SendLoadedWord(MemA[address,4], cp, ThisInstr()); address = address + 4;
        until Coproc_DoneLoading(cp, ThisInstr());
        if wback then R[n] = offset_addr;

```

Exceptions

Undefined Instruction, Data Abort.

A8.6.52 LDC, LDC2 (literal)

Load Coprocessor loads memory data from a sequence of consecutive memory addresses to a coprocessor. If no coprocessor can execute the instruction, an Undefined Instruction exception is generated.

This is a generic coprocessor instruction. The D bit and the CRd field have no functionality defined by the architecture and are free for use by the coprocessor instruction set designer.

For more information about the coprocessors see *Coprocessor support* on page A2-68.

Encoding T1 / A1 ARMv6T2, ARMv7 for encoding T1
 ARMv4*, ARMv5T*, ARMv6*, ARMv7 for encoding A1

LDC{L}<c> <coproc>, <CRd>, <label>

LDC{L}<c> <coproc>, <CRd>, [PC, #-0] Special case

LDC{L}<c> <coproc>, <CRd>, [PC], <option>

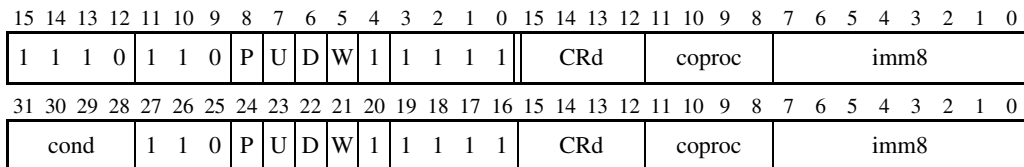

```

if P == '0' && U == '0' && D == '0' && W == '0' then UNDEFINED;
if P == '0' && U == '0' && D == '1' && W == '0' then SEE MRRC, MRRC2;
if coproc == '101x' then SEE "Advanced SIMD and VFP";
index = (P == '1'); add = (U == '1'); cp = UInt(coproc); imm32 = ZeroExtend(imm8:'00', 32);
if W == '1' || (P == '0' && CurrentInstrSet() != InstrSet_ARM) then UNPREDICTABLE;
    
```

Encoding T2 / A2 ARMv6T2, ARMv7 for encoding T2
 ARMv5T*, ARMv6*, ARMv7 for encoding A2

LDC2{L}<c> <coproc>, <CRd>, <label>

LDC2{L}<c> <coproc>, <CRd>, [PC, #-0] Special case

LDC2{L}<c> <coproc>, <CRd>, [PC], <option>

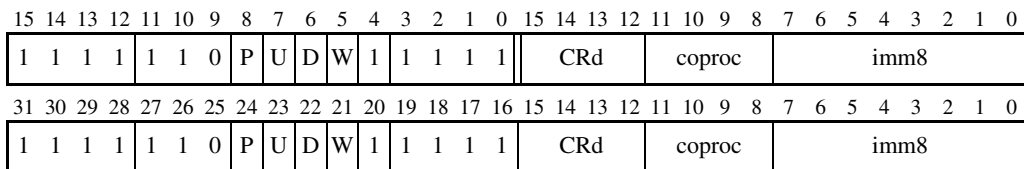

```

if P == '0' && U == '0' && D == '0' && W == '0' then UNDEFINED;
if P == '0' && U == '0' && D == '1' && W == '0' then SEE MRRC, MRRC2;
index = (P == '1'); add = (U == '1'); cp = UInt(coproc); imm32 = ZeroExtend(imm8:'00', 32);
if W == '1' || (P == '0' && CurrentInstrSet() != InstrSet_ARM) then UNPREDICTABLE;
    
```

Advanced SIMD and VFP See *Extension register load/store instructions* on page A7-26

Assembler syntax

LDC{2}{L}<c><q>	<coproc>, <CRd>, <label>	Normal form with P = 1, W = 0
LDC{2}{L}<c><q>	<coproc>, <CRd>, [PC, #+/-<imm>]	Alternative form with P = 1, W = 0
LDC{2}{L}<c><q>	<coproc>, <CRd>, [PC], <option>	Unindexed form with P = 0, U = 1, W = 0

where:

2	If specified, selects encoding T2 / A2. If omitted, selects encoding T1 / A1.
L	If specified, selects the D == 1 form of the encoding. If omitted, selects the D == 0 form.
<c><q>	See <i>Standard assembler syntax fields</i> on page A8-7. An ARM LDC2 instruction must be unconditional.
<coproc>	The name of the coprocessor. The standard generic coprocessor names are p0, p1, ..., p15.
<CRd>	The coprocessor destination register.
<label>	The label of the literal data item that is to be loaded into <Rt>. The assembler calculates the required value of the offset from the Align(PC,4) value of this instruction to the label. Permitted values of the offset are multiples of 4 in the range -1020 to 1020. If the offset is zero or positive, imm32 is equal to the offset and add == TRUE. If the offset is negative, imm32 is equal to minus the offset and add == FALSE.

The alternative syntax permits the addition or subtraction of the offset and the immediate offset to be specified separately, including permitting a subtraction of 0 that cannot be specified using the normal syntax. For more information, see *Use of labels in UAL instruction syntax* on page A4-5.

The unindexed form is permitted for the ARM instruction set only. In it, <option> is a coprocessor option, written as an integer 0-255 enclosed in { } and encoded in imm8.

The pre-UAL syntax LDC<c>L is equivalent to LDCL<c>.

Operation

```

if ConditionPassed() then
    EncodingSpecificOperations();
    if !Cproc_Accepted(cp, ThisInstr()) then
        GenerateCoproprocessorException();
    else
        NullCheckIfThumbEE(15);
        offset_addr = if add then (Align(PC,4) + imm32) else (Align(PC,4) - imm32);
        address = if index then offset_addr else Align(PC,4);
        repeat
            Cproc_SendLoadedWord(MemA[address,4], cp, ThisInstr()); address = address + 4;
        until Cproc_DoneLoading(cp, ThisInstr());

```

Exceptions

Undefined Instruction, Data Abort.

A8.6.53 LDM / LDMIA / LDMFD

Load Multiple (Increment After) loads multiple registers from consecutive memory locations using an address from a base register. The consecutive memory locations start at this address, and the address just above the highest of those locations can optionally be written back to the base register. The registers loaded can include the PC, causing a branch to a loaded address. Related system instructions are *LDM (user registers)* on page B6-7 and *LDM (exception return)* on page B6-5.

Encoding T1 ARMv4T, ARMv5T*, ARMv6*, ARMv7 (not in ThumbEE)

LDM<c> <Rn>!,<registers> <Rn> not included in <registers>

LDM<c> <Rn>,<registers> <Rn> included in <registers>

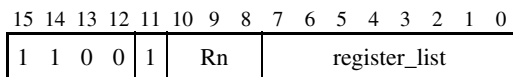

```
n = UInt(Rn); registers = '0000000':register_list; wback = (registers<n> == '0');
if BitCount(registers) < 1 then UNPREDICTABLE;
```

Encoding T2 ARMv6T2, ARMv7

LDM<c>.W <Rn>{!},<registers>

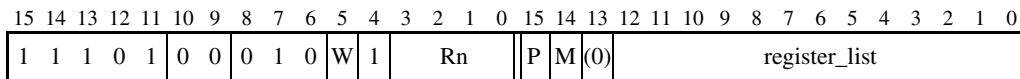

```
if W == '1' && Rn == '1101' then SEE POP;
n = UInt(Rn); registers = P:M:'0':register_list; wback = (W == '1');
if n == 15 || BitCount(registers) < 2 || (P == '1' && M == '1') then UNPREDICTABLE;
if registers<15> == '1' && InITBlock() && !LastInITBlock() then UNPREDICTABLE;
if wback && registers<n> == '1' then UNPREDICTABLE;
```

Encoding A1 ARMv4*, ARMv5T*, ARMv6*, ARMv7

LDM<c> <Rn>{!},<registers>

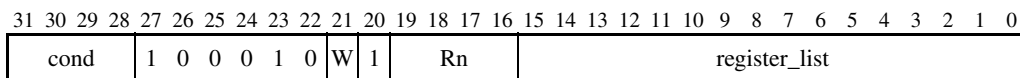

```
if W == '1' && Rn == '1101' && BitCount(register_list) >= 2 then SEE POP;
n = UInt(Rn); registers = register_list; wback = (W == '1');
if n == 15 || BitCount(registers) < 1 then UNPREDICTABLE;
if wback && registers<n> == '1' && ArchVersion() >= 7 then UNPREDICTABLE;
```

Assembler syntax

LDM<c><q> <Rn>{!}, <registers>

where:

<c><q> See *Standard assembler syntax fields* on page A8-7.

- <Rn>** The base register. SP can be used. If it is the SP and ! is specified, the instruction is treated as described in *POP* on page A8-246.
- !** Causes the instruction to write a modified value back to <Rn>. Encoded as W = 1. If ! is omitted, the instruction does not change <Rn> in this way. Encoded as W = 0.
- <registers>** Is a list of one or more registers to be loaded, separated by commas and surrounded by { and }. The lowest-numbered register is loaded from the lowest memory address, through to the highest-numbered register from the highest memory address.
- Encoding T2 does not support a list containing only one register. If an LDMIA instruction with just one register <Rt> in the list is assembled to Thumb and encoding T1 is not available, it is assembled to the equivalent LDR<c><q> <Rt>, [<Rn>]{, #4} instruction.
- The SP can be in the list in ARM code, but not in Thumb code. However, ARM instructions that include the SP in the list are deprecated.
- The PC can be in the list. If it is, the instruction branches to the address loaded to the PC. In ARMv5T and above, this is an interworking branch, see *Pseudocode details of operations on ARM core registers* on page A2-12. In Thumb code, if the PC is in the list:
- the LR must not be in the list
 - the instruction must be either outside any IT block, or the last instruction in an IT block.
- ARM instructions that include both the LR and the PC in the list are deprecated.
- Instructions with the base register in the list and ! specified are only available in the ARM instruction set before ARMv7, and the use of such instructions is deprecated. The value of the base register after such an instruction is UNKNOWN.

LDMIA and LDMFD are pseudo-instructions for LDM. LDMFD refers to its use for popping data from Full Descending stacks.

The pre-UAL syntaxes LDM<c>IA and LDM<c>FD are equivalent to LDM<c>.

Operation

```

if ConditionPassed() then
    EncodingSpecificOperations(); NullCheckIfThumbEE(n);
    address = R[n];
    for i = 0 to 14
        if registers<i> == '1' then
            R[i] = MemA[address,4]; address = address + 4;
    if registers<15> == '1' then
        LoadWritePC(MemA[address,4]);
    if wback && registers<n> == '0' then R[n] = R[n] + 4*BitCount(registers);
    if wback && registers<n> == '1' then R[n] = bits(32) UNKNOWN;

```

Exceptions

Data Abort.

A8.6.54 LDMDA / LDMFA

Load Multiple Decrement After (Load Multiple Full Ascending) loads multiple registers from consecutive memory locations using an address from a base register. The consecutive memory locations end at this address, and the address just below the lowest of those locations can optionally be written back to the base register. The registers loaded can include the PC, causing a branch to a loaded address.

Related system instructions are *LDM (user registers)* on page B6-7 and *LDM (exception return)* on page B6-5.

Encoding A1 ARMv4*, ARMv5T*, ARMv6*, ARMv7

LDMDA<c> <Rn>{!}, <registers>

31	30	29	28	27	26	25	24	23	22	21	20	19	18	17	16	15	14	13	12	11	10	9	8	7	6	5	4	3	2	1	0
cond		1	0	0	0	0	0	W	1	Rn				register_list																	

```
n = UInt(Rn); registers = register_list; wback = (W == '1');
if n == 15 || BitCount(registers) < 1 then UNPREDICTABLE;
if wback && registers<n> == '1' && ArchVersion() >= 7 then UNPREDICTABLE;
```

Assembler syntax

LMDMA<c><q> <Rn>{!}, <registers>

where:

<c><q> See *Standard assembler syntax fields* on page A8-7.

<Rn> The base register. SP can be used.

! Causes the instruction to write a modified value back to <Rn>. Encoded as W = 1.
If ! is omitted, the instruction does not change <Rn> in this way. Encoded as W = 0.

<registers> Is a list of one or more registers to be loaded, separated by commas and surrounded by { and }. The lowest-numbered register is loaded from the lowest memory address, through to the highest-numbered register from the highest memory address.

The SP can be in the list. However, instructions that include the SP in the list are deprecated.

The PC can be in the list. If it is, the instruction branches to the address (data) loaded to the PC. In ARMv5T and above, this branch is an interworking branch, see *Pseudocode details of operations on ARM core registers* on page A2-12.

Instructions that include both the LR and the PC in the list are deprecated.

Instructions with the base register in the list and ! specified are only available before ARMv7, and the use of such instructions is deprecated. The value of the base register after such an instruction is UNKNOWN.

LDMFA is a pseudo-instruction for LMDMA, referring to its use for popping data from Full Ascending stacks.

The pre-UAL syntaxes LDM<c>DA and LDM<c>FA are equivalent to LMDMA<c>.

Operation

```
if ConditionPassed() then
    EncodingSpecificOperations();
    address = R[n] - 4*BitCount(registers) + 4;
    for i = 0 to 14
        if registers<i> == '1' then
            R[i] = MemA[address,4]; address = address + 4;
    if registers<15> == '1' then
        LoadWritePC(MemA[address,4]);
    if wback && registers<n> == '0' then R[n] = R[n] - 4*BitCount(registers);
    if wback && registers<n> == '1' then R[n] = bits(32) UNKNOWN;
```

Exceptions

Data Abort.

A8.6.55 LDMDB / LDMEA

Load Multiple Decrement Before (Load Multiple Empty Ascending) loads multiple registers from consecutive memory locations using an address from a base register. The consecutive memory locations end just below this address, and the address of the lowest of those locations can optionally be written back to the base register. The registers loaded can include the PC, causing a branch to a loaded address.

Related system instructions are *LDM (user registers)* on page B6-7 and *LDM (exception return)* on page B6-5.

Encoding T1 ARMv6T2, ARMv7

LDMDB<c> <Rn>{!}, <registers>

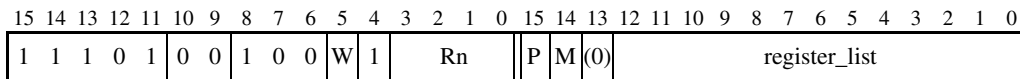

```
n = UInt(Rn); registers = P:M:'0':register_list; wback = (W == '1');
if n == 15 || BitCount(registers) < 2 || (P == '1' && M == '1') then UNPREDICTABLE;
if registers<15> == '1' && InITBlock() && !LastInITBlock() then UNPREDICTABLE;
if wback && registers<n> == '1' then UNPREDICTABLE;
```

Encoding A1 ARMv4*, ARMv5T*, ARMv6*, ARMv7

LDMDB<c> <Rn>{!}, <registers>

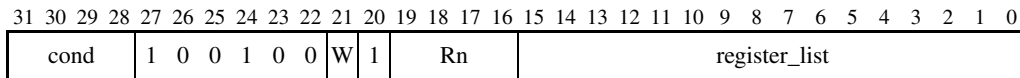

```
n = UInt(Rn); registers = register_list; wback = (W == '1');
if n == 15 || BitCount(registers) < 1 then UNPREDICTABLE;
if wback && registers<n> == '1' && ArchVersion() >= 7 then UNPREDICTABLE;
```

Assembler syntax

LDMDB<c><q> <Rn>{!}, <registers>

where:

<c><q> See *Standard assembler syntax fields* on page A8-7.

<Rn> The base register. The SP can be used.

! Causes the instruction to write a modified value back to <Rn>. Encoded as W = 1.
If ! is omitted, the instruction does not change <Rn> in this way. Encoded as W = 0.

<registers> Is a list of one or more registers to be loaded, separated by commas and surrounded by { and }. The lowest-numbered register is loaded from the lowest memory address, through to the highest-numbered register from the highest memory address.

Encoding T1 does not support a list containing only one register. If an LDMDB instruction with just one register <Rt> in the list is assembled to Thumb, it is assembled to the equivalent LDR<c><q> <Rt>, [<Rn>, #-4]{!} instruction.

The SP can be in the list in ARM code, but not in Thumb code. However, ARM instructions that include the SP in the list are deprecated.

The PC can be in the list. If it is, the instruction branches to the address loaded to the PC. In ARMv5T and above, this is an interworking branch, see *Pseudocode details of operations on ARM core registers* on page A2-12. In Thumb code, if the PC is in the list:

- the LR must not be in the list
- the instruction must be either outside any IT block, or the last instruction in an IT block.

ARM instructions that include both the LR and the PC in the list are deprecated.

Instructions with the base register in the list and ! specified are only available in the ARM instruction set before ARMv7, and the use of such instructions is deprecated. The value of the base register after such an instruction is UNKNOWN.

LDMEA is a pseudo-instruction for LDMDB, referring to its use for popping data from Empty Ascending stacks.

The pre-UAL syntaxes LDM<c>DB and LDM<c>EA are equivalent to LDMDB<c>.

Operation

```

if ConditionPassed() then
    EncodingSpecificOperations(); NullCheckIfThumbEE(n);
    address = R[n] - 4*BitCount(registers);
    for i = 0 to 14
        if registers<i> == '1' then
            R[i] = MemA[address,4]; address = address + 4;
    if registers<15> == '1' then
        LoadWritePC(MemA[address,4]);
    if wback && registers<n> == '0' then R[n] = R[n] - 4*BitCount(registers);
    if wback && registers<n> == '1' then R[n] = bits(32) UNKNOWN;

```

Exceptions

Data Abort.

A8.6.56 LDMIB / LDMED

Load Multiple Increment Before loads multiple registers from consecutive memory locations using an address from a base register. The consecutive memory locations start just above this address, and the address of the last of those locations can optionally be written back to the base register. The registers loaded can include the PC, causing a branch to a loaded address.

Related system instructions are *LDM (user registers)* on page B6-7 and *LDM (exception return)* on page B6-5.

Encoding A1 ARMv4*, ARMv5T*, ARMv6*, ARMv7

LDMIB<c> <Rn>{!}, <registers>

31	30	29	28	27	26	25	24	23	22	21	20	19	18	17	16	15	14	13	12	11	10	9	8	7	6	5	4	3	2	1	0
cond		1	0	0	1	1	0	W	1	Rn				register_list																	

```
n = UInt(Rn); registers = register_list; wback = (W == '1');
if n == 15 || BitCount(registers) < 1 then UNPREDICTABLE;
if wback && registers<n> == '1' && ArchVersion() >= 7 then UNPREDICTABLE;
```

Assembler syntax

LDMIB<c><q> <Rn>{!}, <registers>

where:

<c><q> See *Standard assembler syntax fields* on page A8-7.

<Rn> The base register. The SP can be used.

! Causes the instruction to write a modified value back to <Rn>. Encoded as W = 1.
If ! is omitted, the instruction does not change <Rn> in this way. Encoded as W = 0.

<registers> Is a list of one or more registers to be loaded, separated by commas and surrounded by { and }. The lowest-numbered register is loaded from the lowest memory address, through to the highest-numbered register from the highest memory address.

The SP can be in the list. However, instructions that include the SP in the list are deprecated.

The PC can be in the list. If it is, the instruction branches to the address (data) loaded to the PC. In ARMv5T and above, this branch is an interworking branch, see *Pseudocode details of operations on ARM core registers* on page A2-12.

Instructions that include both the LR and the PC in the list are deprecated.

Instructions with the base register in the list and ! specified are only available before ARMv7, and the use of such instructions is deprecated. The value of the base register after such an instruction is UNKNOWN.

LDMED is a pseudo-instruction for LDMIB, referring to its use for popping data from Empty Descending stacks.

The pre-UAL syntaxes LDM<c>IB and LDM<c>ED are equivalent to LDMIB<c>.

Operation

```

if ConditionPassed() then
    EncodingSpecificOperations();
    address = R[n] + 4;
    for i = 0 to 14
        if registers<i> == '1' then
            R[i] = MemA[address,4]; address = address + 4;
    if registers<15> == '1' then
        LoadWritePC(MemA[address,4]);
    if wback && registers<n> == '0' then R[n] = R[n] + 4*BitCount(registers);
    if wback && registers<n> == '1' then R[n] = bits(32) UNKNOWN;

```

Exceptions

Data Abort.

A8.6.57 LDR (immediate, Thumb)

Load Register (immediate) calculates an address from a base register value and an immediate offset, loads a word from memory, and writes it to a register. It can use offset, post-indexed, or pre-indexed addressing. For information about memory accesses see *Memory accesses* on page A8-13.

Encoding T1 ARMv4T, ARMv5T*, ARMv6*, ARMv7

LDR<C> <Rt>, [<Rn>{, #<imm>}]

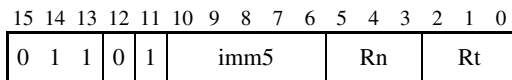

t = UInt(Rt); n = UInt(Rn); imm32 = ZeroExtend(imm5:'00', 32);
 index = TRUE; add = TRUE; wback = FALSE;

Encoding T2 ARMv4T, ARMv5T*, ARMv6*, ARMv7

LDR<C> <Rt>, [SP{, #<imm>}]

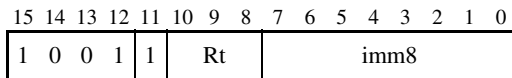

t = UInt(Rt); n = 13; imm32 = ZeroExtend(imm8:'00', 32);
 index = TRUE; add = TRUE; wback = FALSE;

Encoding T3 ARMv6T2, ARMv7

LDR<C>.W <Rt>, [<Rn>{, #<imm12>}]

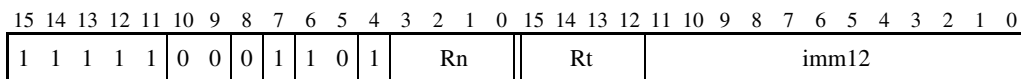

if Rn == '1111' then SEE LDR (literal);
 t = UInt(Rt); n = UInt(Rn); imm32 = ZeroExtend(imm12, 32);
 index = TRUE; add = TRUE; wback = FALSE;
 if t == 15 && InITBlock() && !LastInITBlock() then UNPREDICTABLE;

Encoding T4 ARMv6T2, ARMv7

LDR<C> <Rt>, [<Rn>, #-<imm8>]

LDR<C> <Rt>, [<Rn>], #+/-<imm8>

LDR<C> <Rt>, [<Rn>, #+/-<imm8>]!

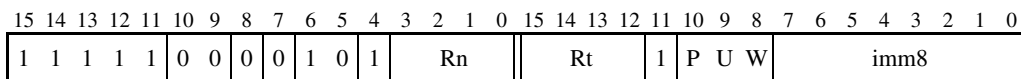

if Rn == '1111' then SEE LDR (literal);
 if P == '1' && U == '1' && W == '0' then SEE LDRT;
 if Rn == '1101' && P == '0' && U == '1' && W == '1' && imm8 == '00000100' then SEE POP;
 if P == '0' && W == '0' then UNDEFINED;
 t = UInt(Rt); n = UInt(Rn); imm32 = ZeroExtend(imm8, 32);
 index = (P == '1'); add = (U == '1'); wback = (W == '1');
 if (wback && n == t) || (t == 15 && InITBlock() && !LastInITBlock()) then UNPREDICTABLE;

Assembler syntax

LDR<c><q> <Rt>, [<Rn> {, #+/-<imm>}]	Offset: index==TRUE, wback==FALSE
LDR<c><q> <Rt>, [<Rn>, #+/-<imm>]!	Pre-indexed: index==TRUE, wback==TRUE
LDR<c><q> <Rt>, [<Rn>], #+/-<imm>	Post-indexed: index==FALSE, wback==TRUE

where:

<c><q>	See <i>Standard assembler syntax fields</i> on page A8-7.
<Rt>	The destination register. The SP can be used. The PC can be used, provided the instruction is either outside an IT block or the last instruction of an IT block. If the PC is used, the instruction branches to the address (data) loaded to the PC. In ARMv5T and above, this branch is an interworking branch, see <i>Pseudocode details of operations on ARM core registers</i> on page A2-12.
<Rn>	The base register. The SP can be used. For PC use see <i>LDR (literal)</i> on page A8-122.
+/-	Is + or omitted if the immediate offset is to be added to the base register value (add == TRUE), or – if it is to be subtracted (add == FALSE). #0 and #-0 generate different instructions.
<imm>	The immediate offset used to form the address. For the offset addressing syntax, <imm> can be omitted, meaning an offset of 0. Values are: Encoding T1 multiples of 4 in the range 0-124 Encoding T2 multiples of 4 in the range 0-1020 Encoding T3 any value in the range 0-4095 Encoding T4 any value in the range 0-255.

Operation

```

if ConditionPassed() then
    EncodingSpecificOperations(); NullCheckIfThumbEE(n);
    offset_addr = if add then (R[n] + imm32) else (R[n] - imm32);
    address = if index then offset_addr else R[n];
    data = MemU[address,4];
    if wback then R[n] = offset_addr;
    if t == 15 then
        if address<1:0> == '00' then LoadWritePC(data); else UNPREDICTABLE;
    elsif UnalignedSupport() || address<1:0> = '00' then
        R[t] = data;
    else R[t] = bits(32) UNKNOWN; // Can only apply before ARMv7

```

Exceptions

Data Abort.

ThumbEE instruction

ThumbEE has additional LDR (immediate) encodings. For details see *LDR (immediate)* on page A9-19.

A8.6.58 LDR (immediate, ARM)

Load Register (immediate) calculates an address from a base register value and an immediate offset, loads a word from memory, and writes it to a register. It can use offset, post-indexed, or pre-indexed addressing. For information about memory accesses see *Memory accesses* on page A8-13.

Encoding A1 ARMv4*, ARMv5T*, ARMv6*, ARMv7

LDR<c> <Rt>, [<Rn>{, #+/-<imm12>}]

LDR<c> <Rt>, [<Rn>], #+/-<imm12>

LDR<c> <Rt>, [<Rn>, #+/-<imm12>]!

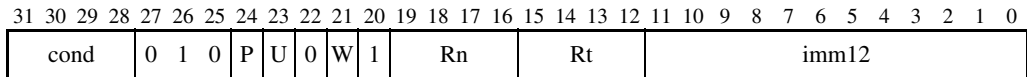

```

if Rn == '1111' then SEE LDR (literal);
if P == '0' && W == '1' then SEE LDRT;
if Rn == '1101' && P == '0' && U == '1' && W == '0' && imm12 == '00000000100' then SEE POP;
t = UInt(Rt); n = UInt(Rn); imm32 = ZeroExtend(imm12, 32);
index = (P == '1'); add = (U == '1'); wback = (P == '0') || (W == '1');
if wback && n == t then UNPREDICTABLE;
    
```

Assembler syntax

LDR<c><q> <Rt>, [<Rn> {, #+/-<imm>}]	Offset: index==TRUE, wback==FALSE
LDR<c><q> <Rt>, [<Rn>, #+/-<imm>]!	Pre-indexed: index==TRUE, wback==TRUE
LDR<c><q> <Rt>, [<Rn>], #+/-<imm>	Post-indexed: index==FALSE, wback==TRUE

where:

<c><q>	See <i>Standard assembler syntax fields</i> on page A8-7.
<Rt>	The destination register. The SP or the PC can be used. If the PC is used, the instruction branches to the address (data) loaded to the PC. In ARMv5T and above, this branch is an interworking branch, see <i>Pseudocode details of operations on ARM core registers</i> on page A2-12.
<Rn>	The base register. The SP can be used. For PC use see <i>LDR (literal)</i> on page A8-122.
+/-	Is + or omitted if the immediate offset is to be added to the base register value (add == TRUE), or – if it is to be subtracted (add == FALSE). #0 and #-0 generate different instructions.
<imm>	The immediate offset used to form the address. For the offset addressing syntax, <imm> can be omitted, meaning an offset of 0. Any value in the range 0-4095 is permitted.

Operation

```

if ConditionPassed() then
    EncodingSpecificOperations();
    offset_addr = if add then (R[n] + imm32) else (R[n] - imm32);
    address = if index then offset_addr else R[n];
    data = MemU[address,4];
    if wback then R[n] = offset_addr;
    if t == 15 then
        if address<1:0> == '00' then LoadWritePC(data); else UNPREDICTABLE;
    elseif UnalignedSupport() || address<1:0> = '00' then
        R[t] = data;
    else // Can only apply before ARMv7
        R[t] = ROR(data, 8*UInt(address<1:0>));

```

Exceptions

Data Abort.

A8.6.59 LDR (literal)

Load Register (literal) calculates an address from the PC value and an immediate offset, loads a word from memory, and writes it to a register. For information about memory accesses see *Memory accesses* on page A8-13.

Encoding T1 ARMv4T, ARMv5T*, ARMv6*, ARMv7

LDR<c> <Rt>, <label>

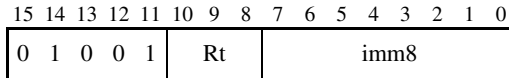

t = UInt(Rt); imm32 = ZeroExtend(imm8:'00', 32); add = TRUE;

Encoding T2 ARMv6T2, ARMv7

LDR<c>.W <Rt>, <label>

LDR<c>.W <Rt>, [PC, #-0]

Special case

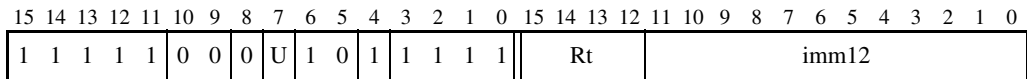

t = UInt(Rt); imm32 = ZeroExtend(imm12, 32); add = (U == '1');
 if t == 15 && InITBlock() && !LastInITBlock() then UNPREDICTABLE;

Encoding A1 ARMv4*, ARMv5T*, ARMv6*, ARMv7

LDR<c> <Rt>, <label>

LDR<c> <Rt>, [PC, #-0]

Special case

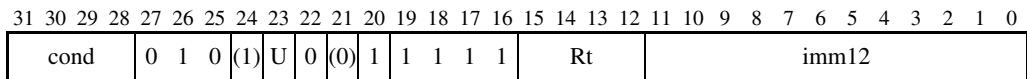

t = UInt(Rt); imm32 = ZeroExtend(imm12, 32); add = (U == '1');

Assembler syntax

LDR<c><q> <Rt>, <label>

Normal form

LDR<c><q> <Rt>, [PC, #+/-<imm>]

Alternative form

where:

<c><q> See *Standard assembler syntax fields* on page A8-7.

<Rt> The destination register. The SP can be used. The PC can be used, provided the instruction is either outside an IT block or the last instruction of an IT block. If the PC is used, the instruction branches to the address (data) loaded to the PC. In ARMv5T and above, this branch is an interworking branch, see *Pseudocode details of operations on ARM core registers* on page A2-12.

<label> The label of the literal data item that is to be loaded into <Rt>. The assembler calculates the required value of the offset from the `Align(PC,4)` value of this instruction to the label. Permitted values of the offset are:

Encoding T1 multiples of four in the range -1020 to 1020

Encoding T2 or A1 any value in the range -4095 to 4095.

If the offset is zero or positive, `imm32` is equal to the offset and `add == TRUE`.

If the offset is negative, `imm32` is equal to minus the offset and `add == FALSE`. Negative offset is not available in encoding T1.

Note

In code examples in this manual, the syntax `=<value>` is used for the label of a memory word whose contents are constant and equal to `<value>`. The actual syntax for such a label is assembler-dependent.

The alternative syntax permits the addition or subtraction of the offset and the immediate offset to be specified separately, including permitting a subtraction of 0 that cannot be specified using the normal syntax. For more information, see *Use of labels in UAL instruction syntax* on page A4-5.

Operation

```

if ConditionPassed() then
    EncodingSpecificOperations(); NullCheckIfThumbEE(15);
    base = Align(PC,4);
    address = if add then (base + imm32) else (base - imm32);
    data = MemU[address,4];
    if t == 15 then
        if address<1:0> == '00' then LoadWritePC(data); else UNPREDICTABLE;
    elseif UnalignedSupport() || address<1:0> = '00' then
        R[t] = data;
    else // Can only apply before ARMv7
        if CurrentInstrSet() == InstrSet_ARM then
            R[t] = ROR(data, 8*UInt(address<1:0>));
        else
            R[t] = bits(32) UNKNOWN;

```

Exceptions

Data Abort.

A8.6.60 LDR (register)

Load Register (register) calculates an address from a base register value and an offset register value, loads a word from memory, and writes it to a register. The offset register value can optionally be shifted. For information about memory accesses, see *Memory accesses* on page A8-13.

Encoding T1 ARMv4T, ARMv5T*, ARMv6*, ARMv7

LDR<c> <Rt>, [<Rn>, <Rm>]

15	14	13	12	11	10	9	8	7	6	5	4	3	2	1	0
0	1	0	1	1	0	0		Rm		Rn					Rt

```
if CurrentInstrSet() == InstrSet_ThumbEE then SEE "Modified operation in ThumbEE";
t = UInt(Rt); n = UInt(Rn); m = UInt(Rm);
index = TRUE; add = TRUE; wback = FALSE;
(shift_t, shift_n) = (SRTYPE_LSL, 0);
```

Encoding T2 ARMv6T2, ARMv7

LDR<c>.W <Rt>, [<Rn>, <Rm>{, LSL #<imm2>}]

15	14	13	12	11	10	9	8	7	6	5	4	3	2	1	0	15	14	13	12	11	10	9	8	7	6	5	4	3	2	1	0
1	1	1	1	1	0	0	0	0	1	0	1		Rn				Rt		0	0	0	0	0	0	imm2		Rm				

```
if Rn == '1111' then SEE LDR (literal);
t = UInt(Rt); n = UInt(Rn); m = UInt(Rm);
index = TRUE; add = TRUE; wback = FALSE;
(shift_t, shift_n) = (SRTYPE_LSL, UInt(imm2));
if BadReg(m) then UNPREDICTABLE;
if t == 15 && InITBlock() && !LastInITBlock() then UNPREDICTABLE;
```

Encoding A1 ARMv4*, ARMv5T*, ARMv6*, ARMv7

LDR<c> <Rt>, [<Rn>, +/-<Rm>{, <shift>}]{!}

LDR<c> <Rt>, [<Rn>, +/-<Rm>{, <shift>}]

31	30	29	28	27	26	25	24	23	22	21	20	19	18	17	16	15	14	13	12	11	10	9	8	7	6	5	4	3	2	1	0
cond		0	1	1	P	U	0	W	1		Rn		Rt			imm5		type	0											Rm	

```
if P == '0' && W == '1' then SEE LDRT;
t = UInt(Rt); n = UInt(Rn); m = UInt(Rm);
index = (P == '1'); add = (U == '1'); wback = (P == '0') || (W == '1');
(shift_t, shift_n) = DecodeImmShift(type, imm5);
if m == 15 then UNPREDICTABLE;
if wback && (n == 15 || n == t) then UNPREDICTABLE;
if ArchVersion() < 6 && wback && m == n then UNPREDICTABLE;
```

Modified operation in ThumbEE

See *LDR (register)* on page A9-9

Assembler syntax

LDR<C><Q> <Rt>, [<Rn>, +/-<Rm>{, <shift>}]	Offset: index==TRUE, wback==FALSE
LDR<C><Q> <Rt>, [<Rn>, +/-<Rm>{, <shift>}]!	Pre-indexed: index==TRUE, wback==TRUE
LDR<C><Q> <Rt>, [<Rn>], +/-<Rm>{, <shift>}	Post-indexed: index==FALSE, wback==TRUE

where:

<C><Q>	See <i>Standard assembler syntax fields</i> on page A8-7.
<Rt>	The destination register. The SP can be used. The PC can be used, provided the instruction is either outside an IT block or the last instruction of an IT block. If the PC is used, the instruction branches to the address (data) loaded to the PC. In ARMv5T and above, this branch is an interworking branch, see <i>Pseudocode details of operations on ARM core registers</i> on page A2-12.
<Rn>	The base register. The SP can be used. The PC can be used only in the ARM instruction set.
+/-	Is + or omitted if the optionally shifted value of <Rm> is to be added to the base register value (add == TRUE), or – if it is to be subtracted (permitted in ARM code only, add == FALSE).
<Rm>	The offset that is optionally shifted and applied to the value of <Rn> to form the address.
<shift>	The shift to apply to the value read from <Rm>. If present, encoding T1 is not permitted. If absent, no shift is applied and all encodings are permitted. For encoding T2, <shift> can only be omitted, encoded as imm2 = 0b00, or LSL #<imm> with <imm> = 1, 2, or 3, and <imm> encoded in imm2. For encoding A1, see <i>Shifts applied to a register</i> on page A8-10.

Operation

```

if ConditionPassed() then
    EncodingSpecificOperations(); NullCheckIfThumbEE(n);
    offset = Shift(R[m], shift_t, shift_n, APSR.C);
    offset_addr = if add then (R[n] + offset) else (R[n] - offset);
    address = if index then offset_addr else R[n];
    data = MemU[address,4];
    if wback then R[n] = offset_addr;
    if t == 15 then
        if address<1:0> == '00' then LoadWritePC(data); else UNPREDICTABLE;
    elseif UnalignedSupport() || address<1:0> = '00' then
        R[t] = data;
    else // Can only apply before ARMv7
        if CurrentInstrSet() == InstrSet_ARM then
            R[t] = ROR(data, 8*UInt(address<1:0>));
        else
            R[t] = bits(32) UNKNOWN;

```

Exceptions

Data Abort.

A8.6.61 LDRB (immediate, Thumb)

Load Register Byte (immediate) calculates an address from a base register value and an immediate offset, loads a byte from memory, zero-extends it to form a 32-bit word, and writes it to a register. It can use offset, post-indexed, or pre-indexed addressing. For information about memory accesses see *Memory accesses* on page A8-13.

Encoding T1 ARMv4T, ARMv5T*, ARMv6*, ARMv7

LDRB<c> <Rt>, [<Rn>{, #<imm5>}]

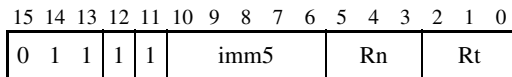

t = UInt(Rt); n = UInt(Rn); imm32 = ZeroExtend(imm5, 32);
 index = TRUE; add = TRUE; wback = FALSE;

Encoding T2 ARMv6T2, ARMv7

LDRB<c>.W <Rt>, [<Rn>{, #<imm12>}]

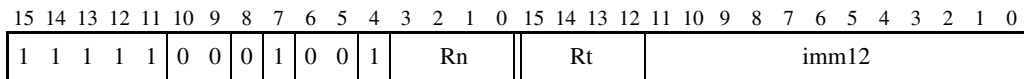

if Rt == '1111' then SEE PLD;
 if Rn == '1111' then SEE LDRB (literal);
 t = UInt(Rt); n = UInt(Rn); imm32 = ZeroExtend(imm12, 32);
 index = TRUE; add = TRUE; wback = FALSE;
 if t == 13 then UNPREDICTABLE;

Encoding T3 ARMv6T2, ARMv7

LDRB<c> <Rt>, [<Rn>, #-<imm8>]

LDRB<c> <Rt>, [<Rn>], #+/-<imm8>

LDRB<c> <Rt>, [<Rn>, #+/-<imm8>]!

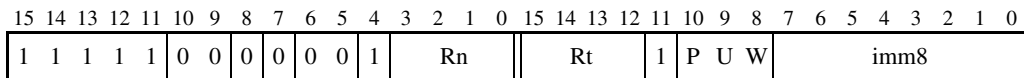

if Rt == '1111' && P == '1' && U == '0' && W == '0' then SEE PLD;
 if Rn == '1111' then SEE LDRB (literal);
 if P == '1' && U == '1' && W == '0' then SEE LDRBT;
 if P == '0' && W == '0' then UNDEFINED;
 t = UInt(Rt); n = UInt(Rn); imm32 = ZeroExtend(imm8, 32);
 index = (P == '1'); add = (U == '1'); wback = (W == '1');
 if BadReg(t) || (wback && n == t) then UNPREDICTABLE;

Assembler syntax

LDRB<c><q> <Rt>, [<Rn> {, #+/-<imm>}]	Offset: index==TRUE, wback==FALSE
LDRB<c><q> <Rt>, [<Rn>, #+/-<imm>]!	Pre-indexed: index==TRUE, wback==TRUE
LDRB<c><q> <Rt>, [<Rn>], #+/-<imm>	Post-indexed: index==FALSE, wback==TRUE

where:

<c><q>	See <i>Standard assembler syntax fields</i> on page A8-7.						
<Rt>	The destination register.						
<Rn>	The base register. The SP can be used. For PC use see <i>LDRB (literal)</i> on page A8-130.						
+/-	Is + or omitted if the immediate offset is to be added to the base register value (add == TRUE), or – if it is to be subtracted (add == FALSE). #0 and #-0 generate different instructions.						
<imm>	The immediate offset used to form the address. For the offset addressing syntax, <imm> can be omitted, meaning an offset of 0. Values are: <table> <tr> <td>Encoding T1</td> <td>any value in the range 0-31</td> </tr> <tr> <td>Encoding T2</td> <td>any value in the range 0-4095</td> </tr> <tr> <td>Encoding T3</td> <td>any value in the range 0-255.</td> </tr> </table>	Encoding T1	any value in the range 0-31	Encoding T2	any value in the range 0-4095	Encoding T3	any value in the range 0-255.
Encoding T1	any value in the range 0-31						
Encoding T2	any value in the range 0-4095						
Encoding T3	any value in the range 0-255.						

The pre-UAL syntax LDR<c>B is equivalent to LDRB<c>.

Operation

```

if ConditionPassed() then
    EncodingSpecificOperations(); NullCheckIfThumbEE(n);
    offset_addr = if add then (R[n] + imm32) else (R[n] - imm32);
    address = if index then offset_addr else R[n];
    R[t] = ZeroExtend(MemU[address,1], 32);
    if wback then R[n] = offset_addr;

```

Exceptions

Data Abort.

A8.6.62 LDRB (immediate, ARM)

Load Register Byte (immediate) calculates an address from a base register value and an immediate offset, loads a byte from memory, zero-extends it to form a 32-bit word, and writes it to a register. It can use offset, post-indexed, or pre-indexed addressing. For information about memory accesses see *Memory accesses* on page A8-13.

Encoding A1 ARMv4*, ARMv5T*, ARMv6*, ARMv7

LDRB<c> <Rt>, [<Rn>{, #+/-<imm12>}]

LDRB<c> <Rt>, [<Rn>], #+/-<imm12>

LDRB<c> <Rt>, [<Rn>, #+/-<imm12>]!

	31	30	29	28	27	26	25	24	23	22	21	20	19	18	17	16	15	14	13	12	11	10	9	8	7	6	5	4	3	2	1	0
cond	0	1	0	P	U	I	W	I	Rn				Rt				imm12															

```

if Rn == '1111' then SEE LDRB (literal);
if P == '0' && W == '1' then SEE LDRBT;
t = UInt(Rt); n = UInt(Rn); imm32 = ZeroExtend(imm12, 32);
index = (P == '1'); add = (U == '1'); wback = (P == '0') || (W == '1');
if t == 15 || (wback && n == t) then UNPREDICTABLE;
    
```

Assembler syntax

LDRB<c><q> <Rt>, [<Rn> {, #+/-<imm>}]	Offset: index==TRUE, wback==FALSE
LDRB<c><q> <Rt>, [<Rn>, #+/-<imm>]!	Pre-indexed: index==TRUE, wback==TRUE
LDRB<c><q> <Rt>, [<Rn>], #+/-<imm>	Post-indexed: index==FALSE, wback==TRUE

where:

<c><q>	See <i>Standard assembler syntax fields</i> on page A8-7.
<Rt>	The destination register.
<Rn>	The base register. The SP can be used. For PC use see <i>LDRB (literal)</i> on page A8-130.
+/-	Is + or omitted if the immediate offset is to be added to the base register value (add == TRUE), or – if it is to be subtracted (add == FALSE). #0 and #-0 generate different instructions.
<imm>	The immediate offset used to form the address. For the offset addressing syntax, <imm> can be omitted, meaning an offset of 0. Any value in the range 0-4095 is permitted.

The pre-UAL syntax LDR<c>B is equivalent to LDRB<c>.

Operation

```

if ConditionPassed() then
    EncodingSpecificOperations();
    offset_addr = if add then (R[n] + imm32) else (R[n] - imm32);
    address = if index then offset_addr else R[n];
    R[t] = ZeroExtend(MemU[address,1], 32);
    if wback then R[n] = offset_addr;

```

Exceptions

Data Abort.

A8.6.63 LDRB (literal)

Load Register Byte (literal) calculates an address from the PC value and an immediate offset, loads a byte from memory, zero-extends it to form a 32-bit word, and writes it to a register. For information about memory accesses see *Memory accesses* on page A8-13.

Encoding T1 ARMv6T2, ARMv7

LDRB<c> <Rt>, <label>

LDRB<c> <Rt>, [PC, #-0] Special case

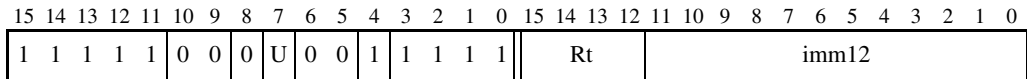

if Rt == '1111' then SEE PLD;
 t = UInt(Rt); imm32 = ZeroExtend(imm12, 32); add = (U == '1');
 if t == 13 then UNPREDICTABLE;

Encoding A1 ARMv4*, ARMv5T*, ARMv6*, ARMv7

LDRB<c> <Rt>, <label>

LDRB<c> <Rt>, [PC, #-0] Special case

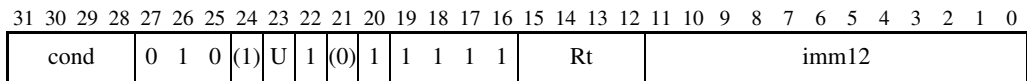

t = UInt(Rt); imm32 = ZeroExtend(imm12, 32); add = (U == '1');
 if t == 15 then UNPREDICTABLE;

Assembler syntax

LDRB<c><q> <Rt>, <label> Normal form
 LDRB<c><q> <Rt>, [PC, #+/-<imm>] Alternative form

where:

<c><q> See *Standard assembler syntax fields* on page A8-7.

<Rt> The destination register.

<label> The label of the literal data item that is to be loaded into <Rt>. The assembler calculates the required value of the offset from the `Align(PC,4)` value of this instruction to the label. Permitted values of the offset are -4095 to 4095.

If the offset is zero or positive, `imm32` is equal to the offset and `add == TRUE`.

If the offset is negative, `imm32` is equal to minus the offset and `add == FALSE`.

The alternative syntax permits the addition or subtraction of the offset and the immediate offset to be specified separately, including permitting a subtraction of 0 that cannot be specified using the normal syntax. For more information, see *Use of labels in UAL instruction syntax* on page A4-5.

The pre-UAL syntax `LDR<c>B` is equivalent to `LDRB<c>`.

Operation

```
if ConditionPassed() then
    EncodingSpecificOperations();  NullCheckIfThumbEE(15);
    base = Align(PC,4);
    address = if add then (base + imm32) else (base - imm32);
    R[t] = ZeroExtend(MemU[address,1], 32);
```

Exceptions

Data Abort.

A8.6.64 LDRB (register)

Load Register Byte (register) calculates an address from abase register value and an offset register value, loads a byte from memory, zero-extends it to form a 32-bit word, and writes it to a register. The offset register value can optionally be shifted. For information about memory accesses see *Memory accesses* on page A8-13.

Encoding T1 ARMv4T, ARMv5T*, ARMv6*, ARMv7

LDRB<c> <Rt>, [<Rn>, <Rm>]

15	14	13	12	11	10	9	8	7	6	5	4	3	2	1	0
0	1	0	1	1	0			Rm		Rn					Rt

t = UInt(Rt); n = UInt(Rn); m = UInt(Rm);
 index = TRUE; add = TRUE; wback = FALSE;
 (shift_t, shift_n) = (SRTYPE_LSL, 0);

Encoding T2 ARMv6T2, ARMv7

LDRB<c>.W <Rt>, [<Rn>, <Rm>{, LSL #<imm2>}]

15	14	13	12	11	10	9	8	7	6	5	4	3	2	1	0	15	14	13	12	11	10	9	8	7	6	5	4	3	2	1	0
1	1	1	1	1	0	0	0	0	0	0	1		Rn					Rt	0	0	0	0	0	0	imm2		Rm				

if Rt == '1111' then SEE PLD;
 if Rn == '1111' then SEE LDRB (literal);
 t = UInt(Rt); n = UInt(Rn); m = UInt(Rm);
 index = TRUE; add = TRUE; wback = FALSE;
 (shift_t, shift_n) = (SRTYPE_LSL, UInt(imm2));
 if t == 13 || BadReg(m) then UNPREDICTABLE;

Encoding A1 ARMv4*, ARMv5T*, ARMv6*, ARMv7

LDRB<c> <Rt>, [<Rn>, +/-<Rm>{, <shift>}]{!}

LDRB<c> <Rt>, [<Rn>], +/-<Rm>{, <shift>}

31	30	29	28	27	26	25	24	23	22	21	20	19	18	17	16	15	14	13	12	11	10	9	8	7	6	5	4	3	2	1	0
cond		0	1	1	P	U	1	W	1		Rn		Rt	imm5			type	0		Rm											

if P == '0' && W == '1' then SEE LDRBT;
 t = UInt(Rt); n = UInt(Rn); m = UInt(Rm);
 index = (P == '1'); add = (U == '1'); wback = (P == '0') || (W == '1');
 (shift_t, shift_n) = DecodeImmShift(type, imm5);
 if t == 15 || m == 15 then UNPREDICTABLE;
 if wback && (n == 15 || n == t) then UNPREDICTABLE;
 if ArchVersion() < 6 && wback && m == n then UNPREDICTABLE;

Assembler syntax

LDRB<c><q> <Rt>, [<Rn>, +/-<Rm>{, <shift>}]	Offset: index==TRUE, wback==FALSE
LDRB<c><q> <Rt>, [<Rn>, +/-<Rm>{, <shift>}]!	Pre-indexed: index==TRUE, wback==TRUE
LDRB<c><q> <Rt>, [<Rn>], +/-<Rm>{, <shift>}	Post-indexed: index==FALSE, wback==TRUE

where:

<c><q>	See <i>Standard assembler syntax fields</i> on page A8-7.
<Rt>	The destination register.
<Rn>	The base register. The SP can be used. The PC can be used only in the ARM instruction set.
+/-	Is + or omitted if the optionally shifted value of <Rm> is to be added to the base register value (add == TRUE), or – if it is to be subtracted (permitted in ARM code only, add == FALSE).
<Rm>	Contains the offset that is optionally shifted and applied to the value of <Rn> to form the address.
<shift>	The shift to apply to the value read from <Rm>. If present, encoding T1 is not permitted. If absent, no shift is applied and all encodings are permitted. For encoding T2, <shift> can only be omitted, encoded as imm2 = 0b00, or LSL #<imm> with <imm> = 1, 2, or 3, and <imm> encoded in imm2. For encoding A1, see <i>Shifts applied to a register</i> on page A8-10.

The pre-UAL syntax LDR<c>B is equivalent to LDRB<c>.

Operation

```

if ConditionPassed() then
    EncodingSpecificOperations(); NullCheckIfThumbEE(n);
    offset = Shift(R[m], shift_t, shift_n, APSR.C);
    offset_addr = if add then (R[n] + offset) else (R[n] - offset);
    address = if index then offset_addr else R[n];
    R[t] = ZeroExtend(MemU[address,1],32);
    if wback then R[n] = offset_addr;

```

Exceptions

Data Abort.

A8.6.65 LDRBT

Load Register Byte Unprivileged loads a byte from memory, zero-extends it to form a 32-bit word, and writes it to a register. For information about memory accesses see *Memory accesses* on page A8-13.

The memory access is restricted as if the processor were running in User mode. (This makes no difference if the processor is actually running in User mode.)

The Thumb instruction uses an offset addressing mode, that calculates the address used for the memory access from a base register value and an immediate offset, and leaves the base register unchanged.

The ARM instruction uses a post-indexed addressing mode, that uses a base register value as the address for the memory access, and calculates a new address from a base register value and an offset and writes it back to the base register. The offset can be an immediate value or an optionally-shifted register value.

Encoding T1 ARMv6T2, ARMv7

LDRBT<c> <Rt>, [<Rn>, #<imm8>]

15	14	13	12	11	10	9	8	7	6	5	4	3	2	1	0	15	14	13	12	11	10	9	8	7	6	5	4	3	2	1	0
1	1	1	1	1	0	0	0	0	0	0	1	Rn				Rt				1	1	1	0	imm8							

```

if Rn == '1111' then SEE LDRB (literal);
t = UInt(Rt); n = UInt(Rn); postindex = FALSE; add = TRUE;
register_form = FALSE; imm32 = ZeroExtend(imm8, 32);
if BadReg(t) then UNPREDICTABLE;
    
```

Encoding A1 ARMv4*, ARMv5T*, ARMv6*, ARMv7

LDRBT<c> <Rt>, [<Rn>], #+/-<imm12>

31	30	29	28	27	26	25	24	23	22	21	20	19	18	17	16	15	14	13	12	11	10	9	8	7	6	5	4	3	2	1	0
cond		0	1	0	0	U	1	1	1	Rn				Rt				imm12													

```

t = UInt(Rt); n = UInt(Rn); postindex = TRUE; add = (U == '1');
register_form = FALSE; imm32 = ZeroExtend(imm12, 32);
if t == 15 || n == 15 || n == t then UNPREDICTABLE;
    
```

Encoding A2 ARMv4*, ARMv5T*, ARMv6*, ARMv7

LDRBT<c> <Rt>, [<Rn>], +/-<Rm>{, <shift>}

31	30	29	28	27	26	25	24	23	22	21	20	19	18	17	16	15	14	13	12	11	10	9	8	7	6	5	4	3	2	1	0
cond		0	1	1	0	U	1	1	1	Rn				Rt				imm5			type	0	Rm								

```

t = UInt(Rt); n = UInt(Rn); m = UInt(Rm); postindex = TRUE; add = (U == '1');
register_form = TRUE; (shift_t, shift_n) = DecodeImmShift(type, imm5);
if t == 15 || n == 15 || n == t || m == 15 then UNPREDICTABLE;
if ArchVersion() < 6 && m == n then UNPREDICTABLE;
    
```

Assembler syntax

LDRBT<c><q>	<Rt>, [<Rn> {, #<imm>}]	Offset: Thumb only
LDRBT<c><q>	<Rt>, [<Rn>] {, #+/-<imm>}	Post-indexed: ARM only
LDRBT<c><q>	<Rt>, [<Rn>], +/-<Rm> {, <shift>}	Post-indexed: ARM only

where:

<c><q>	See <i>Standard assembler syntax fields</i> on page A8-7.
<Rt>	The destination register.
<Rn>	The base register. The SP can be used.
+/-	Is + or omitted if <imm> or the optionally shifted value of <Rm> is to be added to the base register value (add == TRUE), or – if it is to be subtracted (permitted in ARM code only, add == FALSE).
<imm>	The immediate offset applied to the value of <Rn>. Values are 0-255 for encoding T1, and 0-4095 for encoding A1. <imm> can be omitted, meaning an offset of 0.
<Rm>	Contains the offset that is optionally shifted and applied to the value of <Rn> to form the address.
<shift>	The shift to apply to the value read from <Rm>. If omitted, no shift is applied. <i>Shifts applied to a register</i> on page A8-10 describes the shifts and how they are encoded.

The pre-UAL syntax LDR<c>BT is equivalent to LDRBT<c>.

Operation

```

if ConditionPassed() then
    EncodingSpecificOperations();  NullCheckIfThumbEE(n);
    offset = if register_form then Shift(R[m], shift_t, shift_n, APSR.C) else imm32;
    offset_addr = if add then (R[n] + offset) else (R[n] - offset);
    address = if postindex then R[n] else offset_addr;
    R[t] = ZeroExtend(MemU_unpriv[address,1],32);
    if postindex then R[n] = offset_addr;

```

Exceptions

Data Abort.

A8.6.66 LDRD (immediate)

Load Register Dual (immediate) calculates an address from a base register value and an immediate offset, loads two words from memory, and writes them to two registers. It can use offset, post-indexed, or pre-indexed addressing. For information about memory accesses see *Memory accesses* on page A8-13.

Encoding T1 ARMv6T2, ARMv7

LDRD<c> <Rt>, <Rt2>, [<Rn>{, #+/-<imm>}]

LDRD<c> <Rt>, <Rt2>, [<Rn>], #+/-<imm>

LDRD<c> <Rt>, <Rt2>, [<Rn>, #+/-<imm>]!

15	14	13	12	11	10	9	8	7	6	5	4	3	2	1	0	15	14	13	12	11	10	9	8	7	6	5	4	3	2	1	0
1	1	1	0	1	0	0	P	U	1	W	1	Rn				Rt				Rt2				imm8							

```

if P == '0' && W == '0' then SEE "Related encodings";
if Rn == '1111' then SEE LDRD (literal);
t = UInt(Rt); t2 = UInt(Rt2); n = UInt(Rn); imm32 = ZeroExtend(imm8:'00', 32);
index = (P == '1'); add = (U == '1'); wback = (W == '1');
if wback && (n == t || n == t2) then UNPREDICTABLE;
if BadReg(t) || BadReg(t2) || t == t2 then UNPREDICTABLE;

```

Encoding A1 ARMv5TE*, ARMv6*, ARMv7

LDRD<c> <Rt>, <Rt2>, [<Rn>{, #+/-<imm8>}]

LDRD<c> <Rt>, <Rt2>, [<Rn>], #+/-<imm8>

LDRD<c> <Rt>, <Rt2>, [<Rn>, #+/-<imm8>]!

31	30	29	28	27	26	25	24	23	22	21	20	19	18	17	16	15	14	13	12	11	10	9	8	7	6	5	4	3	2	1	0
cond		0	0	0	P	U	1	W	0	Rn				Rt				imm4H				1	1	0	1	imm4L					

```

if Rn == '1111' then SEE LDRD (literal);
if Rt<0> == '1' then UNDEFINED;
t = UInt(Rt); t2 = t+1; n = UInt(Rn); imm32 = ZeroExtend(imm4H:imm4L, 32);
index = (P == '1'); add = (U == '1'); wback = (P == '0') || (W == '1');
if P == '0' && W == '1' then UNPREDICTABLE;
if wback && (n == t || n == t2) then UNPREDICTABLE;
if t2 == 15 then UNPREDICTABLE;

```

Related encodings See *Load/store dual, load/store exclusive, table branch* on page A6-24

Assembler syntax

LDRD<c><q> <Rt>, <Rt2>, [<Rn> {, #+/-<imm>}]	Offset: index==TRUE, wback==FALSE
LDRD<c><q> <Rt>, <Rt2>, [<Rn>, #+/-<imm>]!	Pre-indexed: index==TRUE, wback==TRUE
LDRD<c><q> <Rt>, <Rt2>, [<Rn>], #+/-<imm>	Post-indexed: index==FALSE, wback==TRUE

where:

<c><q>	See <i>Standard assembler syntax fields</i> on page A8-7.				
<Rt>	The first destination register. For an ARM instruction, <Rt> must be even-numbered and not R14.				
<Rt2>	The second destination register. For an ARM instruction, <Rt2> must be <R(t+1)>.				
<Rn>	The base register. The SP can be used. For PC use see <i>LDRD (literal)</i> on page A8-138.				
+/-	Is + or omitted if the immediate offset is to be added to the base register value (add == TRUE), or – if it is to be subtracted (add == FALSE). #0 and #-0 generate different instructions.				
<imm>	The immediate offset used to form the address. For the offset addressing syntax, <imm> can be omitted, meaning an offset of 0. Values are: <table> <tr> <td>Encoding T1</td> <td>multiples of 4 in the range 0-1020</td> </tr> <tr> <td>Encoding A1</td> <td>any value in the range 0-255.</td> </tr> </table>	Encoding T1	multiples of 4 in the range 0-1020	Encoding A1	any value in the range 0-255.
Encoding T1	multiples of 4 in the range 0-1020				
Encoding A1	any value in the range 0-255.				

The pre-UAL syntax LDR<c>D is equivalent to LDRD<c>.

Operation

```

if ConditionPassed() then
    EncodingSpecificOperations(); NullCheckIfThumbEE(n);
    offset_addr = if add then (R[n] + imm32) else (R[n] - imm32);
    address = if index then offset_addr else R[n];
    R[t] = MemA[address,4];
    R[t2] = MemA[address+4,4];
    if wback then R[n] = offset_addr;

```

Exceptions

Data Abort.

A8.6.67 LDRD (literal)

Load Register Dual (literal) calculates an address from the PC value and an immediate offset, loads two words from memory, and writes them to two registers. For information about memory accesses see *Memory accesses* on page A8-13.

Encoding T1 ARMv6T2, ARMv7

LDRD<c> <Rt>, <Rt2>, <label>

LDRD<c> <Rt>, <Rt2>, [PC, #-0]

Special case

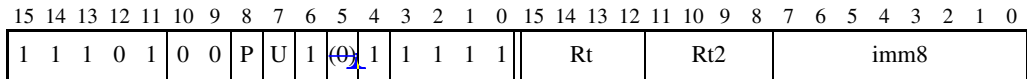

if P == '0' then SEE "Related encodings";
 t = UInt(Rt); t2 = UInt(Rt2);
 imm32 = ZeroExtend(imm8:'00', 32); add = (U == '1');
 if BadReg(t) || BadReg(t2) || t == t2 then UNPREDICTABLE;

Encoding A1 ARMv5TE*, ARMv6*, ARMv7

LDRD<c> <Rt>, <Rt2>, <label>

LDRD<c> <Rt>, <Rt2>, [PC, #-0]

Special case

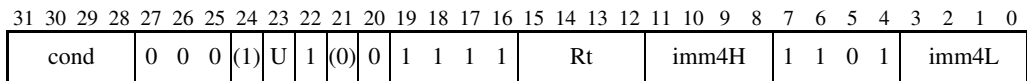

if Rt<0> == '1' then UNDEFINED;
 t = UInt(Rt); t2 = t+1; imm32 = ZeroExtend(imm4H:imm4L, 32); add = (U == '1');
 if t2 == 15 then UNPREDICTABLE;

Related encodings See *Load/store dual, load/store exclusive, table branch* on page A6-24

Assembler syntax

LDRD<c><q> <Rt>, <Rt2>, <label> Normal form
 LDRD<c><q> <Rt>, <Rt2>, [PC, #+/-<imm>] Alternative form

where:

<c><q> See *Standard assembler syntax fields* on page A8-7.
 <Rt> The first destination register. For an ARM instruction, <Rt> must be even-numbered and not R14.
 <Rt2> The second destination register. For an ARM instruction, <Rt2> must be <R(t+1)>.
 <label> The label of the literal data item that is to be loaded into <Rt>. The assembler calculates the required value of the offset from the `Align(PC,4)` value of this instruction to the label. Permitted values of the offset are:

Encoding T1 multiples of 4 in the range -1020 to 1020

Encoding A1 any value in the range -255 to 255.

If the offset is zero or positive, `imm32` is equal to the offset and `add == TRUE`.

If the offset is negative, `imm32` is equal to minus the offset and `add == FALSE`.

The alternative syntax permits the addition or subtraction of the offset and the immediate offset to be specified separately, including permitting a subtraction of 0 that cannot be specified using the normal syntax. For more information, see *Use of labels in UAL instruction syntax* on page A4-5.

The pre-UAL syntax `LDR<c>D` is equivalent to `LDRD<c>`.

Operation

```
if ConditionPassed() then
    EncodingSpecificOperations(); NullCheckIfThumbEE(15);
    address = if add then (Align(PC,4) + imm32) else (Align(PC,4) - imm32);
    R[t] = MemA[address,4];
    R[t2] = MemA[address+4,4];
```

Exceptions

Data Abort.

A8.6.68 LDRD (register)

Load Register Dual (register) calculates an address from abase register value and a register offset, loads two words from memory, and writes them to two registers. It can use offset, post-indexed, or pre-indexed addressing. For information about memory accesses see *Memory accesses* on page A8-13.

Encoding A1 ARMv5TE*, ARMv6*, ARMv7

LDRD<c> <Rt>, <Rt2>, [<Rn>, +/-<Rm>]{!}

LDRD<c> <Rt>, <Rt2>, [<Rn>], +/-<Rm>

	31	30	29	28	27	26	25	24	23	22	21	20	19	18	17	16	15	14	13	12	11	10	9	8	7	6	5	4	3	2	1	0
	cond			0	0	0	P	U	0	W	0	Rn				Rt				(0)	(0)	(0)	(0)	1	1	0	1	Rm				

```

if Rt<0> == '1' then UNDEFINED;
t = UInt(Rt); t2 = t+1; n = UInt(Rn); m = UInt(Rm);
index = (P == '1'); add = (U == '1'); wback = (P == '0') || (W == '1');
if P == '0' && W == '1' then UNPREDICTABLE;
if t2 == 15 || m == 15 || m == t || m == t2 then UNPREDICTABLE;
if wback && (n == 15 || n == t || n == t2) then UNPREDICTABLE;
if ArchVersion() < 6 && wback && m == n then UNPREDICTABLE;
    
```

Assembler syntax

LDRD<c><q> <Rt>, <Rt2>, [<Rn>, +/-<Rm>]	Offset: index==TRUE, wback==FALSE
LDRD<c><q> <Rt>, <Rt2>, [<Rn>, +/-<Rm>]!	Pre-indexed: index==TRUE, wback==TRUE
LDRD<c><q> <Rt>, <Rt2>, [<Rn>], +/-<Rm>	Post-indexed: index==FALSE, wback==TRUE

where:

<c><q>	See <i>Standard assembler syntax fields</i> on page A8-7.
<Rt>	The first destination register. This register must be even-numbered and not R14.
<Rt2>	The second destination register. This register must be <R(t+1)>.
<Rn>	The base register. The SP or the PC can be used.
+/-	Is + or omitted if the value of <Rm> is to be added to the base register value (add == TRUE), or – if it is to be subtracted (add == FALSE).
<Rm>	Contains the offset that is applied to the value of <Rn> to form the address.

The pre-UAL syntax LDR<c>D is equivalent to LDRD<c>.

Operation

```

if ConditionPassed() then
    EncodingSpecificOperations();
    offset_addr = if add then (R[n] + R[m]) else (R[n] - R[m]);
    address = if index then offset_addr else R[n];
    R[t] = MemA[address,4];
    R[t2] = MemA[address+4,4];
    if wback then R[n] = offset_addr;

```

Exceptions

Data Abort.

A8.6.69 LDREX

Load Register Exclusive calculates an address from a base register value and an immediate offset, loads a word from memory, writes it to a register and:

- if the address has the Shared Memory attribute, marks the physical address as exclusive access for the executing processor in a shared monitor
- causes the executing processor to indicate an active exclusive access in the local monitor.

For more information about support for shared memory see *Synchronization and semaphores* on page A3-12. For information about memory accesses see *Memory accesses* on page A8-13.

Encoding T1 ARMv6T2, ARMv7

LDREX<c> <Rt>, [<Rn>{, #<imm>}]

15	14	13	12	11	10	9	8	7	6	5	4	3	2	1	0	15	14	13	12	11	10	9	8	7	6	5	4	3	2	1	0
1	1	1	0	1	0	0	0	0	1	0	1	Rn				Rt				(1)(1)(1)(1)				imm8							

t = UInt(Rt); n = UInt(Rn); imm32 = ZeroExtend(imm8:'00', 32);
 if BadReg(t) || n == 15 then UNPREDICTABLE;

Encoding A1 ARMv6*, ARMv7

LDREX<c> <Rt>, [<Rn>]

31	30	29	28	27	26	25	24	23	22	21	20	19	18	17	16	15	14	13	12	11	10	9	8	7	6	5	4	3	2	1	0
cond		0	0	0	1	1	0	0	1	Rn				Rt				(1)(1)(1)(1)				1	0	0	1	(1)(1)(1)(1)					

t = UInt(Rt); n = UInt(Rn); imm32 = Zeros(32); // Zero offset
 if t == 15 || n == 15 then UNPREDICTABLE;

Assembler syntax

LDREX<c><q> <Rt>, [<Rn> {,<imm>}]

where:

<c><q> See *Standard assembler syntax fields* on page A8-7.

<Rt> The destination register.

<Rn> The base register. The SP can be used.

<imm> The immediate offset added to the value of <Rn> to form the address. <imm> can be omitted, meaning an offset of 0. Values are:

Encoding T1 multiples of 4 in the range 0-1020

Encoding A1 omitted or 0.

Operation

```
if ConditionPassed() then
    EncodingSpecificOperations(); NullCheckIfThumbEE(n);
    address = R[n] + imm32;
    SetExclusiveMonitors(address,4);
    R[t] = MemA[address,4];
```

Exceptions

Data Abort.

A8.6.70 LDREXB

Load Register Exclusive Byte derives an address from a base register value, loads a byte from memory, zero-extends it to form a 32-bit word, writes it to a register and:

- if the address has the Shared Memory attribute, marks the physical address as exclusive access for the executing processor in a shared monitor
- causes the executing processor to indicate an active exclusive access in the local monitor.

For more information about support for shared memory see *Synchronization and semaphores* on page A3-12. For information about memory accesses see *Memory accesses* on page A8-13.

Encoding T1 ARMv7

LDREXB<c> <Rt>, [<Rn>]

15	14	13	12	11	10	9	8	7	6	5	4	3	2	1	0	15	14	13	12	11	10	9	8	7	6	5	4	3	2	1	0
1	1	1	0	1	0	0	0	1	1	0	1	Rn				Rt				(1)	(1)	(1)	(1)	0	1	0	0	(1)	(1)	(1)	(1)

t = UInt(Rt); n = UInt(Rn);
 if BadReg(t) || n == 15 then UNPREDICTABLE;

Encoding A1 ARMv6K, ARMv7

LDREXB<c> <Rt>, [<Rn>]

31	30	29	28	27	26	25	24	23	22	21	20	19	18	17	16	15	14	13	12	11	10	9	8	7	6	5	4	3	2	1	0
cond		0	0	0	1	1	1	0	1	Rn				Rt				(1)	(1)	(1)	(1)	1	0	0	1	(1)	(1)	(1)	(1)		

t = UInt(Rt); n = UInt(Rn);
 if t == 15 || n == 15 then UNPREDICTABLE;

Assembler syntax

```
LDREXB<c><q> <Rt>, [<Rn>]
```

where:

<c><q> See *Standard assembler syntax fields* on page A8-7.

<Rt> The destination register.

<Rn> The base register. The SP can be used.

Operation

```
if ConditionPassed() then
    EncodingSpecificOperations(); NullCheckIfThumbEE(n);
    address = R[n];
    SetExclusiveMonitors(address,1);
    R[t] = ZeroExtend(MemA[address,1], 32);
```

Exceptions

Data Abort.

A8.6.71 LDREXD

Load Register Exclusive Doubleword derives an address from a base register value, loads a 64-bit doubleword from memory, writes it to two registers and:

- if the address has the Shared Memory attribute, marks the physical address as exclusive access for the executing processor in a shared monitor
- causes the executing processor to indicate an active exclusive access in the local monitor.

For more information about support for shared memory see *Synchronization and semaphores* on page A3-12. For information about memory accesses see *Memory accesses* on page A8-13.

Encoding T1 ARMv7

LDREXD<c> <Rt>, <Rt2>, [<Rn>]

15	14	13	12	11	10	9	8	7	6	5	4	3	2	1	0	15	14	13	12	11	10	9	8	7	6	5	4	3	2	1	0
1	1	1	0	1	0	0	0	1	1	0	1	Rn				Rt				Rt2				0	1	1	1	(1)(1)(1)(1)			

t = UInt(Rt); t2 = UInt(Rt2); n = UInt(Rn);
 if BadReg(t) || BadReg(t2) || t == t2 || n == 15 then UNPREDICTABLE;

Encoding A1 ARMv6K, ARMv7

LDREXD<c> <Rt>, <Rt2>, [<Rn>]

31	30	29	28	27	26	25	24	23	22	21	20	19	18	17	16	15	14	13	12	11	10	9	8	7	6	5	4	3	2	1	0
cond			0	0	0	1	1	0	1	1	Rn				Rt				(1)(1)(1)(1)				1	0	0	1	(1)(1)(1)(1)				

t = UInt(Rt); t2 = t+1; n = UInt(Rn);
 if Rt<0> = '1' || Rt == '1110' || n == 15 then UNPREDICTABLE;

Assembler syntax

LDREXD<c><q> <Rt>, <Rt2>, [<Rn>]

where:

- <c><q> See *Standard assembler syntax fields* on page A8-7.
- <Rt> The first destination register. For an ARM instruction, <Rt> must be even-numbered and not R14.
- <Rt2> The second destination register. For an ARM instruction, <Rt2> must be <R(t+1)>.
- <Rn> The base register. The SP can be used.

Operation

```
if ConditionPassed() then
    EncodingSpecificOperations(); NullCheckIfThumbEE(n);
    address = R[n];
    SetExclusiveMonitors(address,8);
    value = MemA[address,8];
    // Extract words from 64-bit loaded value such that R[t] is
    // loaded from address and R[t2] from address+4.
    R[t] = if BigEndian() then value<63:32> else value<31:0>;
    R[t2] = if BigEndian() then value<31:0> else value<63:32>;
```

Exceptions

Data Abort.

A8.6.72 LDREXH

Load Register Exclusive Halfword derives an address from abase register value, loads a halfword from memory, zero-extends it to form a 32-bit word, writes it to a register and:

- if the address has the Shared Memory attribute, marks the physical address as exclusive access for the executing processor in a shared monitor
- causes the executing processor to indicate an active exclusive access in the local monitor.

For more information about support for shared memory see *Synchronization and semaphores* on page A3-12. For information about memory accesses see *Memory accesses* on page A8-13.

Encoding T1 ARMv7

LDREXH<c> <Rt>, [<Rn>]

15	14	13	12	11	10	9	8	7	6	5	4	3	2	1	0	15	14	13	12	11	10	9	8	7	6	5	4	3	2	1	0
1	1	1	0	1	0	0	0	1	1	0	1	Rn				Rt				(1)	(1)	(1)	(1)	0	1	0	1	(1)	(1)	(1)	(1)

t = UInt(Rt); n = UInt(Rn);
 if BadReg(t) || n == 15 then UNPREDICTABLE;

Encoding A1 ARMv6K, ARMv7

LDREXH<c> <Rt>, [<Rn>]

31	30	29	28	27	26	25	24	23	22	21	20	19	18	17	16	15	14	13	12	11	10	9	8	7	6	5	4	3	2	1	0
cond		0	0	0	1	1	1	1	1	Rn				Rt				(1)	(1)	(1)	(1)	1	0	0	1	(1)	(1)	(1)	(1)		

t = UInt(Rt); n = UInt(Rn);
 if t == 15 || n == 15 then UNPREDICTABLE;

Assembler syntax

LDREXH<c><q> <Rt>, [<Rn>]

where:

<c><q> See *Standard assembler syntax fields* on page A8-7.

<Rt> The destination register.

<Rn> The base register. The SP can be used.

Operation

```
if ConditionPassed() then
    EncodingSpecificOperations(); NullCheckIfThumbEE(n);
    address = R[n];
    SetExclusiveMonitors(address,2);
    R[t] = ZeroExtend(MemA[address,2], 32);
```

Exceptions

Data Abort.

A8.6.73 LDRH (immediate, Thumb)

Load Register Halfword (immediate) calculates an address from a base register value and an immediate offset, loads a halfword from memory, zero-extends it to form a 32-bit word, and writes it to a register. It can use offset, post-indexed, or pre-indexed addressing. For information about memory accesses see *Memory accesses* on page A8-13.

Encoding T1 ARMv4T, ARMv5T*, ARMv6*, ARMv7

LDRH<c> <Rt>, [<Rn>{, #<imm>}]

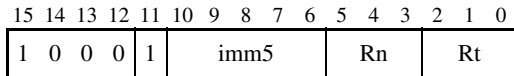

t = UInt(Rt); n = UInt(Rn); imm32 = ZeroExtend(imm5:'0', 32);
 index = TRUE; add = TRUE; wback = FALSE;

Encoding T2 ARMv6T2, ARMv7

LDRH<c>.W <Rt>, [<Rn>{, #<imm12>}]

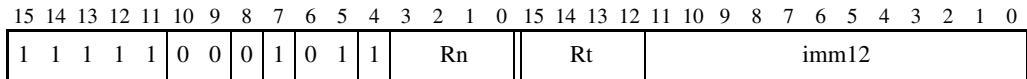

if Rt == '1111' then SEE "Unallocated memory hints";
 if Rn == '1111' then SEE LDRH (literal);
 t = UInt(Rt); n = UInt(Rn); imm32 = ZeroExtend(imm12, 32);
 index = TRUE; add = TRUE; wback = FALSE;
 if t == 13 then UNPREDICTABLE;

Encoding T3 ARMv6T2, ARMv7

LDRH<c> <Rt>, [<Rn>, #-<imm8>]

LDRH<c> <Rt>, [<Rn>], #+/-<imm8>

LDRH<c> <Rt>, [<Rn>, #+/-<imm8>]!

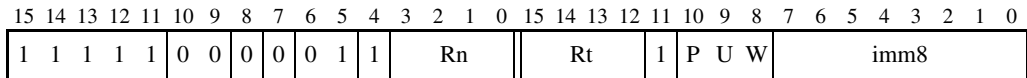

if Rn == '1111' then SEE LDRH (literal);
 if Rt == '1111' && P == '1' && U == '0' && W == '0' then SEE "Unallocated memory hints";
 if P == '1' && U == '1' && W == '0' then SEE LDRHT;
 if P == '0' && W == '0' then UNDEFINED;
 t = UInt(Rt); n = UInt(Rn); imm32 = ZeroExtend(imm8, 32);
 index = (P == '1'); add = (U == '1'); wback = (W == '1');
 if BadReg(t) || (wback && n == t) then UNPREDICTABLE;

Unallocated memory hints

See *Load halfword, memory hints* on page A6-26

Assembler syntax

LDRH<c><q> <Rt>, [<Rn> {, #+/-<imm>}]	Offset: index==TRUE, wback==FALSE
LDRH<c><q> <Rt>, [<Rn>, #+/-<imm>]!	Pre-indexed: index==TRUE, wback==TRUE
LDRH<c><q> <Rt>, [<Rn>], #+/-<imm>	Post-indexed: index==FALSE, wback==TRUE

where:

<c><q>	See <i>Standard assembler syntax fields</i> on page A8-7.						
<Rt>	The destination register.						
<Rn>	The base register. The SP can be used. For PC use see <i>LDRH (literal)</i> on page A8-154.						
+/-	Is + or omitted to indicate that the immediate offset is added to the base register value (add == TRUE), or – to indicate that the offset is to be subtracted (add == FALSE). Different instructions are generated for #0 and #-0.						
<imm>	The immediate offset used to form the address. For the offset addressing syntax, <imm> can be omitted, meaning an offset of 0. Values are: <table> <tr> <td>Encoding T1</td> <td>multiples of 2 in the range 0-62</td> </tr> <tr> <td>Encoding T2</td> <td>any value in the range 0-4095</td> </tr> <tr> <td>Encoding T3</td> <td>any value in the range 0-255.</td> </tr> </table>	Encoding T1	multiples of 2 in the range 0-62	Encoding T2	any value in the range 0-4095	Encoding T3	any value in the range 0-255.
Encoding T1	multiples of 2 in the range 0-62						
Encoding T2	any value in the range 0-4095						
Encoding T3	any value in the range 0-255.						

The pre-UAL syntax LDR<c>H is equivalent to LDRH<c>.

Operation

```

if ConditionPassed() then
    EncodingSpecificOperations(); NullCheckIfThumbEE(n);
    offset_addr = if add then (R[n] + imm32) else (R[n] - imm32);
    address = if index then offset_addr else R[n];
    data = MemU[address,2];
    if wback then R[n] = offset_addr;
    if UnalignedSupport() || address<0> = '0' then
        R[t] = ZeroExtend(data, 32);
    else // Can only apply before ARMv7
        R[t] = bits(32) UNKNOWN;

```

Exceptions

Data Abort.

A8.6.74 LDRH (immediate, ARM)

Load Register Halfword (immediate) calculates an address from a base register value and an immediate offset, loads a halfword from memory, zero-extends it to form a 32-bit word, and writes it to a register. It can use offset, post-indexed, or pre-indexed addressing. For information about memory accesses see *Memory accesses* on page A8-13.

Encoding A1 ARMv4*, ARMv5T*, ARMv6*, ARMv7

LDRH<c> <Rt>, [<Rn>{, #+/-<imm8>}]

LDRH<c> <Rt>, [<Rn>], #+/-<imm8>

LDRH<c> <Rt>, [<Rn>, #+/-<imm8>]!

	31	30	29	28	27	26	25	24	23	22	21	20	19	18	17	16	15	14	13	12	11	10	9	8	7	6	5	4	3	2	1	0
	cond			0	0	0	P	U	I	W	I	Rn				Rt				imm4H				1	0	1	1	imm4L				

```

if Rn == '1111' then SEE LDRH (literal);
if P == '0' && W == '1' then SEE LDRHT;
t = UInt(Rt); n = UInt(Rn); imm32 = ZeroExtend(imm4H:imm4L, 32);
index = (P == '1'); add = (U == '1'); wback = (P == '0') || (W == '1');
if t == 15 || (wback && n == t) then UNPREDICTABLE;
    
```

Assembler syntax

LDRH<c><q> <Rt>, [<Rn> {, #+/-<imm>}]	Offset: index==TRUE, wback==FALSE
LDRH<c><q> <Rt>, [<Rn>, #+/-<imm>]!	Pre-indexed: index==TRUE, wback==TRUE
LDRH<c><q> <Rt>, [<Rn>], #+/-<imm>	Post-indexed: index==FALSE, wback==TRUE

where:

<c><q>	See <i>Standard assembler syntax fields</i> on page A8-7.
<Rt>	The destination register.
<Rn>	The base register. The SP can be used. For PC use see <i>LDRH (literal)</i> on page A8-154.
+/-	Is + or omitted to indicate that the immediate offset is added to the base register value (add == TRUE), or – to indicate that the offset is to be subtracted (add == FALSE). Different instructions are generated for #0 and #-0.
<imm>	The immediate offset used to form the address. For the offset addressing syntax, <imm> can be omitted, meaning an offset of 0. Any value in the range 0-255 is permitted.

The pre-UAL syntax LDR<c>H is equivalent to LDRH<c>.

Operation

```

if ConditionPassed() then
    EncodingSpecificOperations();
    offset_addr = if add then (R[n] + imm32) else (R[n] - imm32);
    address = if index then offset_addr else R[n];
    data = MemU[address,2];
    if wback then R[n] = offset_addr;
    if UnalignedSupport() || address<0> = '0' then
        R[t] = ZeroExtend(data, 32);
    else // Can only apply before ARMv7
        R[t] = bits(32) UNKNOWN;

```

Exceptions

Data Abort.

A8.6.75 LDRH (literal)

Load Register Halfword (literal) calculates an address from the PC value and an immediate offset, loads a halfword from memory, zero-extends it to form a 32-bit word, and writes it to a register. For information about memory accesses see *Memory accesses* on page A8-13.

Encoding T1 ARMv6T2, ARMv7

LDRH<c> <Rt>, <label>

LDRH<c> <Rt>, [PC, #-0] Special case

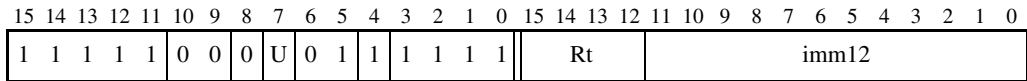

if Rt == '1111' then SEE "Unallocated memory hints";
 t = UInt(Rt); imm32 = ZeroExtend(imm12, 32); add = (U == '1');
 if t == 13 then UNPREDICTABLE;

Encoding A1 ARMv4*, ARMv5T*, ARMv6*, ARMv7

LDRH<c> <Rt>, <label>

LDRH<c> <Rt>, [PC, #-0] Special case

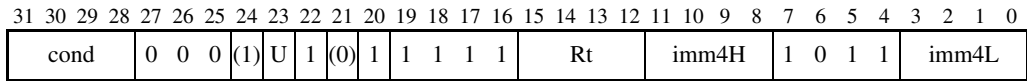

t = UInt(Rt); imm32 = ZeroExtend(imm4H:imm4L, 32); add = (U == '1');
 if t == 15 then UNPREDICTABLE;

Unallocated memory hints

See *Load halfword, memory hints* on page A6-26

Assembler syntax

LDRH<c><q> <Rt>, <label> Normal form
 LDRH<c><q> <Rt>, [PC, #+/-<imm>] Alternative form

where:

<c><q> See *Standard assembler syntax fields* on page A8-7.

<Rt> The destination register.

<label> The label of the literal data item that is to be loaded into <Rt>. The assembler calculates the required value of the offset from the `Align(PC,4)` value of the ADR instruction to this label. Permitted values of the offset are:

Encoding T1 any value in the range -4095 to 4095

Encoding A1 any value in the range -255 to 255.

If the offset is zero or positive, `imm32` is equal to the offset and `add == TRUE`.

If the offset is negative, `imm32` is equal to minus the offset and `add == FALSE`.

The alternative syntax permits the addition or subtraction of the offset and the immediate offset to be specified separately, including permitting a subtraction of 0 that cannot be specified using the normal syntax. For more information, see *Use of labels in UAL instruction syntax* on page A4-5.

The pre-UAL syntax `LDR<c>H` is equivalent to `LDRH<c>`.

Operation

```
if ConditionPassed() then
    EncodingSpecificOperations(); NullCheckIfThumbEE(15);
    base = Align(PC,4);
    address = if add then (base + imm32) else (base - imm32);
    data = MemU[address,2];
    if UnalignedSupport() || address<0> = '0' then
        R[t] = ZeroExtend(data, 32);
    else // Can only apply before ARMv7
        R[t] = bits(32) UNKNOWN;
```

Exceptions

Data Abort.

A8.6.76 LDRH (register)

Load Register Halfword (register) calculates an address from a base register value and an offset register value, loads a halfword from memory, zero-extends it to form a 32-bit word, and writes it to a register. The offset register value can be shifted left by 0, 1, 2, or 3 bits. For information about memory accesses see *Memory accesses* on page A8-13.

Encoding T1 ARMv4T, ARMv5T*, ARMv6*, ARMv7

LDRH<c> <Rt>, [<Rn>, <Rm>]

15	14	13	12	11	10	9	8	7	6	5	4	3	2	1	0
0	1	0	1	1	0	1		Rm		Rn					Rt

```
if CurrentInstrSet() == InstrSet_ThumbEE then SEE "Modified operation in ThumbEE";
t = UInt(Rt); n = UInt(Rn); m = UInt(Rm);
index = TRUE; add = TRUE; wback = FALSE;
(shift_t, shift_n) = (SRTYPE_LSL, 0);
```

Encoding T2 ARMv6T2, ARMv7

LDRH<c>.W <Rt>, [<Rn>, <Rm>{, LSL #<imm2>}]

15	14	13	12	11	10	9	8	7	6	5	4	3	2	1	0	15	14	13	12	11	10	9	8	7	6	5	4	3	2	1	0
1	1	1	1	1	0	0	0	0	0	1	1		Rn				Rt		0	0	0	0	0	0	imm2		Rm				

```
if Rn == '1111' then SEE LDRH (literal);
if Rt == '1111' then SEE "Unallocated memory hints";
t = UInt(Rt); n = UInt(Rn); m = UInt(Rm);
index = TRUE; add = TRUE; wback = FALSE;
(shift_t, shift_n) = (SRTYPE_LSL, UInt(imm2));
if t == 13 || BadReg(m) then UNPREDICTABLE;
```

Encoding A1 ARMv4*, ARMv5T*, ARMv6*, ARMv7

LDRH<c> <Rt>, [<Rn>, +/-<Rm>]{!}

LDRH<c> <Rt>, [<Rn>], +/-<Rm>

31	30	29	28	27	26	25	24	23	22	21	20	19	18	17	16	15	14	13	12	11	10	9	8	7	6	5	4	3	2	1	0
cond		0	0	0	P	U	0	W	1		Rn		Rt	(0)	(0)	(0)	(0)	1	0	1	1									Rm	

```
if P == '0' && W == '1' then SEE LDRHT;
t = UInt(Rt); n = UInt(Rn); m = UInt(Rm);
index = (P == '1'); add = (U == '1'); wback = (P == '0') || (W == '1');
(shift_t, shift_n) = (SRTYPE_LSL, 0);
if t == 15 || m == 15 then UNPREDICTABLE;
if wback && (n == 15 || n == t) then UNPREDICTABLE;
if ArchVersion() < 6 && wback && m == n then UNPREDICTABLE;
```

Unallocated memory hints

See *Load halfword, memory hints* on page A6-26

Modified operation in ThumbEE

See *LDRH (register)* on page A9-10

Assembler syntax

LDRH<c><q> <Rt>, [<Rn>, <Rm>{, LSL #<imm>}]	Offset: index==TRUE, wback==FALSE
LDRH<c><q> <Rt>, [<Rn>, +/-<Rm>]	Offset: index==TRUE, wback==FALSE
LDRH<c><q> <Rt>, [<Rn>, +/-<Rm>!]	Pre-indexed: index==TRUE, wback==TRUE
LDRH<c><q> <Rt>, [<Rn>], +/-<Rm>	Post-indexed: index==FALSE, wback==TRUE

where:

<c><q>	See <i>Standard assembler syntax fields</i> on page A8-7.
<Rt>	The destination register.
<Rn>	The base register. The SP can be used. The PC can be used only in the ARM instruction set.
+/-	Is + or omitted if the optionally shifted value of <Rm> is to be added to the base register value (add == TRUE), or – if it is to be subtracted (permitted in ARM code only, add == FALSE).
<Rm>	Contains the offset that is optionally left shifted and added to the value of <Rn> to form the address.
<imm>	If present, the size of the left shift to apply to the value from <Rm>, in the range 1-3. Only encoding T2 is permitted, and <imm> is encoded in imm2. If absent, no shift is specified and all encodings are permitted. In encoding T2, imm2 is encoded as 0b00.

The pre-UAL syntax LDR<c>H is equivalent to LDRH<c>.

Operation

```

if ConditionPassed() then
    EncodingSpecificOperations();  NullCheckIFThumbEE(n);
    offset = Shift(R[m], shift_t, shift_n, APSR.C);
    offset_addr = if add then (R[n] + offset) else (R[n] - offset);
    address = if index then offset_addr else R[n];
    data = MemU[address,2];
    if wback then R[n] = offset_addr;
    if UnalignedSupport() || address<0> = '0' then
        R[t] = ZeroExtend(data, 32);
    else // Can only apply before ARMv7
        R[t] = bits(32) UNKNOWN;

```

Exceptions

Data Abort.

A8.6.77 LDRHT

Load Register Halfword Unprivileged loads a halfword from memory, zero-extends it to form a 32-bit word, and writes it to a register. For information about memory accesses see *Memory accesses* on page A8-13.

The memory access is restricted as if the processor were running in User mode. (This makes no difference if the processor is actually running in User mode.)

The Thumb instruction uses an offset addressing mode, that calculates the address used for the memory access from a base register value and an immediate offset, and leaves the base register unchanged.

The ARM instruction uses a post-indexed addressing mode, that uses a base register value as the address for the memory access, and calculates a new address from a base register value and an offset and writes it back to the base register. The offset can be an immediate value or a register value.

Encoding T1 ARMv6T2, ARMv7

LDRHT<c> <Rt>, [<Rn>, #<imm8>]

15	14	13	12	11	10	9	8	7	6	5	4	3	2	1	0	15	14	13	12	11	10	9	8	7	6	5	4	3	2	1	0
1	1	1	1	1	0	0	0	0	0	1	1	Rn				Rt				1	1	1	0	imm8							

```
if Rn == '1111' then SEE LDRH (literal);
t = UInt(Rt); n = UInt(Rn); postindex = FALSE; add = TRUE;
register_form = FALSE; imm32 = ZeroExtend(imm8, 32);
if BadReg(t) then UNPREDICTABLE;
```

Encoding A1 ARMv6T2, ARMv7

LDRHT<c> <Rt>, [<Rn>] {, #+/-<imm8>}

31	30	29	28	27	26	25	24	23	22	21	20	19	18	17	16	15	14	13	12	11	10	9	8	7	6	5	4	3	2	1	0
cond		0	0	0	0	U	1	1	1	Rn				Rt				imm4H				1	0	1	1	imm4L					

```
t = UInt(Rt); n = UInt(Rn); postindex = TRUE; add = (U == '1');
register_form = FALSE; imm32 = ZeroExtend(imm4H:imm4L, 32);
if t == 15 || n == 15 || n == t then UNPREDICTABLE;
```

Encoding A2 ARMv6T2, ARMv7

LDRHT<c> <Rt>, [<Rn>], +/-<Rm>

31	30	29	28	27	26	25	24	23	22	21	20	19	18	17	16	15	14	13	12	11	10	9	8	7	6	5	4	3	2	1	0	
cond		0	0	0	0	U	0	1	1	Rn				Rt				(0)	(0)	(0)	(0)	1				0	1	1	Rm			

```
t = UInt(Rt); n = UInt(Rn); m = UInt(Rm); postindex = TRUE; add = (U == '1');
register_form = FALSE;
if t == 15 || n == 15 || n == t || m == 15 then UNPREDICTABLE;
```

Assembler syntax

LDRHT<C><q> <Rt>, [<Rn> {, #<imm>}]	Offset: Thumb only
LDRHT<C><q> <Rt>, [<Rn>] {, #+/-<imm>}	Post-indexed: ARM only
LDRHT<C><q> <Rt>, [<Rn>], +/-<Rm>	Post-indexed: ARM only

where:

<C><q>	See <i>Standard assembler syntax fields</i> on page A8-7.
<Rt>	The destination register.
<Rn>	The base register. The SP can be used.
+/-	Is + or omitted if <imm> or the optionally shifted value of <Rm> is to be added to the base register value (add == TRUE), or – if it is to be subtracted (permitted in ARM code only, add == FALSE).
<imm>	The immediate offset applied to the value of <Rn>. Any value in the range 0-255 is permitted. <imm> can be omitted, meaning an offset of 0.
<Rm>	Contains the offset that is applied to the value of <Rn> to form the address.

Operation

```

if ConditionPassed() then
    EncodingSpecificOperations(); NullCheckIfThumbEE(n);
    offset = if register_form then R[m] else imm32;
    offset_addr = if add then (R[n] + offset) else (R[n] - offset);
    address = if postindex then R[n] else offset_addr;
    data = MemU_unpriv[address,2];
    if postindex then R[n] = offset_addr;
    if UnalignedSupport() || address<0> = '0' then
        R[t] = ZeroExtend(data, 32);
    else // Can only apply before ARMv7
        R[t] = bits(32) UNKNOWN;

```

Exceptions

Data Abort.

A8.6.78 LDRSB (immediate)

Load Register Signed Byte (immediate) calculates an address from a base register value and an immediate offset, loads a byte from memory, sign-extends it to form a 32-bit word, and writes it to a register. It can use offset, post-indexed, or pre-indexed addressing. For information about memory accesses see *Memory accesses* on page A8-13.

Encoding T1 ARMv6T2, ARMv7

LDRSB<c> <Rt>, [<Rn>, #<imm12>]

15	14	13	12	11	10	9	8	7	6	5	4	3	2	1	0	15	14	13	12	11	10	9	8	7	6	5	4	3	2	1	0
1	1	1	1	1	0	0	1	1	0	0	1	Rn				Rt				imm12											

```

if Rt == '1111' then SEE PLI;
if Rn == '1111' then SEE LDRSB (literal);
t = UInt(Rt); n = UInt(Rn); imm32 = ZeroExtend(imm12, 32);
index = TRUE; add = TRUE; wback = FALSE;
if t == 13 then UNPREDICTABLE;

```

Encoding T2 ARMv6T2, ARMv7

LDRSB<c> <Rt>, [<Rn>, #-<imm8>]

LDRSB<c> <Rt>, [<Rn>], #+/-<imm8>

LDRSB<c> <Rt>, [<Rn>, #+/-<imm8>]!

15	14	13	12	11	10	9	8	7	6	5	4	3	2	1	0	15	14	13	12	11	10	9	8	7	6	5	4	3	2	1	0
1	1	1	1	1	0	0	1	0	0	0	1	Rn				Rt				1	P	U	W	imm8							

```

if Rt == '1111' && P == '1' && U == '0' && W == '0' then SEE PLI;
if Rn == '1111' then SEE LDRSB (literal);
if P == '1' && U == '1' && W == '0' then SEE LDRSBT;
if P == '0' && W == '0' then UNDEFINED;
t = UInt(Rt); n = UInt(Rn); imm32 = ZeroExtend(imm8, 32);
index = (P == '1'); add = (U == '1'); wback = (W == '1');
if BadReg(t) || (wback && n == t) then UNPREDICTABLE;

```

Encoding A1 ARMv4*, ARMv5T*, ARMv6*, ARMv7

LDRSB<c> <Rt>, [<Rn>{, #+/-<imm8>}]

LDRSB<c> <Rt>, [<Rn>], #+/-<imm8>

LDRSB<c> <Rt>, [<Rn>, #+/-<imm8>]!

31	30	29	28	27	26	25	24	23	22	21	20	19	18	17	16	15	14	13	12	11	10	9	8	7	6	5	4	3	2	1	0
cond		0	0	0	P	U	1	W	1	Rn				Rt				imm4H				1	1	0	1	imm4L					

```

if Rn == '1111' then SEE LDRSB (literal);
if P == '0' && W == '1' then SEE LDRSBT;
t = UInt(Rt); n = UInt(Rn); imm32 = ZeroExtend(imm4H:imm4L, 32);
index = (P == '1'); add = (U == '1'); wback = (P == '0') || (W == '1');
if t == 15 || (wback && n == t) then UNPREDICTABLE;

```

Assembler syntax

LDRSB<c><q> <Rt>, [<Rn> {, #+/-<imm>}]	Offset: index==TRUE, wback==FALSE
LDRSB<c><q> <Rt>, [<Rn>, #+/-<imm>]!	Pre-indexed: index==TRUE, wback==TRUE
LDRSB<c><q> <Rt>, [<Rn>], #+/-<imm>	Post-indexed: index==FALSE, wback==TRUE

where:

<c><q>	See <i>Standard assembler syntax fields</i> on page A8-7.
<Rt>	The destination register.
<Rn>	The base register. The SP can be used. For PC use see <i>LDRSB (literal)</i> on page A8-162.
+/-	Is + or omitted to indicate that the immediate offset is added to the base register value (add == TRUE), or – to indicate that the offset is to be subtracted (add == FALSE). Different instructions are generated for #0 and #-0.
<imm>	The immediate offset used to form the address. For the offset addressing syntax, <imm> can be omitted, meaning an offset of 0. Values are: <ul style="list-style-type: none"> Encoding T1 any value in the range 0-4095 Encoding T2 or A1 any value in the range 0-255.

The pre-UAL syntax LDR<c>SB is equivalent to LDRSB<c>.

Operation

```

if ConditionPassed() then
    EncodingSpecificOperations(); NullCheckIfThumbEE(n);
    offset_addr = if add then (R[n] + imm32) else (R[n] - imm32);
    address = if index then offset_addr else R[n];
    R[t] = SignExtend(MemU[address,1], 32);
    if wback then R[n] = offset_addr;

```

Exceptions

Data Abort.

A8.6.79 LDRSB (literal)

Load Register Signed Byte (literal) calculates an address from the PC value and an immediate offset, loads a byte from memory, sign-extends it to form a 32-bit word, and writes it to a register. For information about memory accesses see *Memory accesses* on page A8-13.

Encoding T1 ARMv6T2, ARMv7

LDRSB<c> <Rt>, <label>

LDRSB<c> <Rt>, [PC, #-0]

Special case

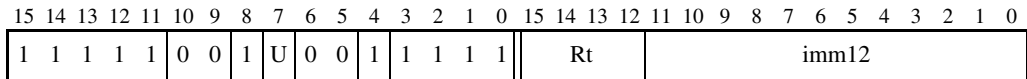

if Rt == '1111' then SEE PLI;

t = UInt(Rt); imm32 = ZeroExtend(imm12, 32); add = (U == '1');

if t == 13 then UNPREDICTABLE;

Encoding A1 ARMv4*, ARMv5T*, ARMv6*, ARMv7

LDRSB<c> <Rt>, <label>

LDRSB<c> <Rt>, [PC, #-0]

Special case

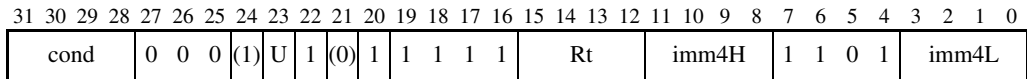

t = UInt(Rt); imm32 = ZeroExtend(imm4H:imm4L, 32); add = (U == '1');

if t == 15 then UNPREDICTABLE;

Assembler syntax

LDRSB<c><q> <Rt>, <label> Normal form
 LDRSB<c><q> <Rt>, [PC, #+/-<imm>] Alternative form

where:

<c><q> See *Standard assembler syntax fields* on page A8-7.

<Rt> The destination register.

<label> The label of the literal data item that is to be loaded into <Rt>. The assembler calculates the required value of the offset from the `Align(PC,4)` value of the ADR instruction to this label. Permitted values of the offset are:

Encoding T1 any value in the range -4095 to 4095

Encoding A1 any value in the range -255 to 255.

If the offset is zero or positive, `imm32` is equal to the offset and `add == TRUE`.

If the offset is negative, `imm32` is equal to minus the offset and `add == FALSE`.

The alternative syntax permits the addition or subtraction of the offset and the immediate offset to be specified separately, including permitting a subtraction of 0 that cannot be specified using the normal syntax. For more information, see *Use of labels in UAL instruction syntax* on page A4-5.

The pre-UAL syntax `LDR<c>SB` is equivalent to `LDRSB<c>`.

Operation

```
if ConditionPassed() then
    EncodingSpecificOperations(); NullCheckIfThumbEE(15);
    base = Align(PC,4);
    address = if add then (base + imm32) else (base - imm32);
    R[t] = SignExtend(MemU[address,1], 32);
```

Exceptions

Data Abort.

A8.6.80 LDRSB (register)

Load Register Signed Byte (register) calculates an address from a base register value and an offset register value, loads a byte from memory, sign-extends it to form a 32-bit word, and writes it to a register. The offset register value can be shifted left by 0, 1, 2, or 3 bits. For information about memory accesses see *Memory accesses* on page A8-13.

Encoding T1 ARMv4T, ARMv5T*, ARMv6*, ARMv7

LDRSB<c> <Rt>, [<Rn>, <Rm>]

15	14	13	12	11	10	9	8	7	6	5	4	3	2	1	0
0	1	0	1	0	1	1		Rm		Rn					Rt

t = UInt(Rt); n = UInt(Rn); m = UInt(Rm);
 index = TRUE; add = TRUE; wback = FALSE;
 (shift_t, shift_n) = (SRTYPE_LSL, 0);

Encoding T2 ARMv6T2, ARMv7

LDRSB<c>.W <Rt>, [<Rn>, <Rm>{, LSL #<imm2>}]

15	14	13	12	11	10	9	8	7	6	5	4	3	2	1	0	15	14	13	12	11	10	9	8	7	6	5	4	3	2	1	0
1	1	1	1	1	0	0	1	0	0	0	1		Rn					Rt	0	0	0	0	0	0	imm2		Rm				

if Rt == '1111' then SEE PLI;
 if Rn == '1111' then SEE LDRSB (literal);
 t = UInt(Rt); n = UInt(Rn); m = UInt(Rm);
 index = TRUE; add = TRUE; wback = FALSE;
 (shift_t, shift_n) = (SRTYPE_LSL, UInt(imm2));
 if t == 13 || BadReg(m) then UNPREDICTABLE;

Encoding A1 ARMv4*, ARMv5T*, ARMv6*, ARMv7

LDRSB<c> <Rt>, [<Rn>, +/-<Rm>]{!}

LDRSB<c> <Rt>, [<Rn>], +/-<Rm>

31	30	29	28	27	26	25	24	23	22	21	20	19	18	17	16	15	14	13	12	11	10	9	8	7	6	5	4	3	2	1	0
cond		0	0	0	P	U	0	W	1		Rn		Rt	(0)	(0)	(0)	(0)	1	1	0	1									Rm	

if P == '0' && W == '1' then SEE LDRSBT;
 t = UInt(Rt); n = UInt(Rn); m = UInt(Rm);
 index = (P == '1'); add = (U == '1'); wback = (P == '0') || (W == '1');
 (shift_t, shift_n) = (SRTYPE_LSL, 0);
 if t == 15 || m == 15 then UNPREDICTABLE;
 if wback && (n == 15 || n == t) then UNPREDICTABLE;
 if ArchVersion() < 6 && wback && m == n then UNPREDICTABLE;

Assembler syntax

LDRSB<c><q>	<Rt>, [<Rn>, <Rm>{, LSL #<imm>}]	Offset: index==TRUE, wback==FALSE
LDRSB<c><q>	<Rt>, [<Rn>, +/-<Rm>]	Offset: index==TRUE, wback==FALSE
LDRSB<c><q>	<Rt>, [<Rn>, +/-<Rm>!]	Pre-indexed: index==TRUE, wback==TRUE
LDRSB<c><q>	<Rt>, [<Rn>], +/-<Rm>	Post-indexed: index==FALSE, wback==TRUE

where:

<c><q>	See <i>Standard assembler syntax fields</i> on page A8-7.
<Rt>	The destination register.
<Rn>	The base register. The SP can be used. The PC can be used only in the ARM instruction set.
+/-	Is + or omitted if the optionally shifted value of <Rm> is to be added to the base register value (add == TRUE), or – if it is to be subtracted (permitted in ARM code only, add == FALSE).
<Rm>	Contains the offset that is optionally left shifted and added to the value of <Rn> to form the address.
<imm>	If present, the size of the left shift to apply to the value from <Rm>, in the range 1-3. Only encoding T2 is permitted, and <imm> is encoded in imm2. If absent, no shift is specified and all encodings are permitted. In encoding T2, imm2 is encoded as 0b00.

The pre-UAL syntax LDR<c>SB is equivalent to LDRSB<c>.

Operation

```

if ConditionPassed() then
    EncodingSpecificOperations(); NullCheckIFThumbEE(n);
    offset = Shift(R[m], shift_t, shift_n, APSR.C);
    offset_addr = if add then (R[n] + offset) else (R[n] - offset);
    address = if index then offset_addr else R[n];
    R[t] = SignExtend(MemU[address,1], 32);
    if wback then R[n] = offset_addr;

```

Exceptions

Data Abort.

A8.6.81 LDRSBT

Load Register Signed Byte Unprivileged loads a byte from memory, sign-extends it to form a 32-bit word, and writes it to a register. For information about memory accesses see *Memory accesses* on page A8-13.

The memory access is restricted as if the processor were running in User mode. (This makes no difference if the processor is actually running in User mode.)

The Thumb instruction uses an offset addressing mode, that calculates the address used for the memory access from a base register value and an immediate offset, and leaves the base register unchanged.

The ARM instruction uses a post-indexed addressing mode, that uses a base register value as the address for the memory access, and calculates a new address from a base register value and an offset and writes it back to the base register. The offset can be an immediate value or a register value.

Encoding T1 ARMv6T2, ARMv7

LDRSBT<c> <Rt>, [<Rn>, #<imm8>]

15	14	13	12	11	10	9	8	7	6	5	4	3	2	1	0	15	14	13	12	11	10	9	8	7	6	5	4	3	2	1	0
1	1	1	1	1	0	0	1	0	0	0	1	Rn				Rt				1	1	1	0	imm8							

```
if Rn == '1111' then SEE LDRSB (literal);
t = UInt(Rt); n = UInt(Rn); postindex = FALSE; add = TRUE;
register_form = FALSE; imm32 = ZeroExtend(imm8, 32);
if BadReg(t) then UNPREDICTABLE;
```

Encoding A1 ARMv6T2, ARMv7

LDRSBT<c> <Rt>, [<Rn>] {, #+/-<imm8>}

31	30	29	28	27	26	25	24	23	22	21	20	19	18	17	16	15	14	13	12	11	10	9	8	7	6	5	4	3	2	1	0
cond		0	0	0	0	U	1	1	1	Rn				Rt				imm4H				1	1	0	1	imm4L					

```
t = UInt(Rt); n = UInt(Rn); postindex = TRUE; add = (U == '1');
register_form = FALSE; imm32 = ZeroExtend(imm4H:imm4L, 32);
if t == 15 || n == 15 || n == t then UNPREDICTABLE;
```

Encoding A2 ARMv6T2, ARMv7

LDRSBT<c> <Rt>, [<Rn>], +/-<Rm>

31	30	29	28	27	26	25	24	23	22	21	20	19	18	17	16	15	14	13	12	11	10	9	8	7	6	5	4	3	2	1	0
cond		0	0	0	0	U	0	1	1	Rn				Rt				(0)	(0)	(0)	(0)	1	1	0	1	Rm					

```
t = UInt(Rt); n = UInt(Rn); m = UInt(Rm); postindex = TRUE; add = (U == '1');
register_form = TRUE;
if t == 15 || n == 15 || n == t || m == 15 then UNPREDICTABLE;
```

Assembler syntax

LDRSBT<c><q>	<Rt>, [<Rn> {, #<imm>}]	Offset: Thumb only
LDRSBT<c><q>	<Rt>, [<Rn>] {, #+/-<imm>}	Post-indexed: ARM only
LDRSBT<c><q>	<Rt>, [<Rn>], +/-<Rm>	Post-indexed: ARM only

where:

<c><q>	See <i>Standard assembler syntax fields</i> on page A8-7.
<Rt>	The destination register.
<Rn>	The base register. The SP can be used.
+/-	Is + or omitted if <imm> or the optionally shifted value of <Rm> is to be added to the base register value (add == TRUE), or – if it is to be subtracted (permitted in ARM code only, add == FALSE).
<imm>	The immediate offset applied to the value of <Rn>. Any value in the range 0-255 is permitted. <imm> can be omitted, meaning an offset of 0.
<Rm>	Contains the offset that is applied to the value of <Rn> to form the address.

Operation

```

if ConditionPassed() then
    EncodingSpecificOperations(); NullCheckIfThumbEE(n);
    offset = if register_form then R[m] else imm32;
    offset_addr = if add then (R[n] + offset) else (R[n] - offset);
    address = if postindex then R[n] else offset_addr;
    R[t] = SignExtend(MemU_unpriv[address,1], 32);
    if postindex then R[n] = offset_addr;

```

Exceptions

Data Abort.

A8.6.82 LDRSH (immediate)

Load Register Signed Halfword (immediate) calculates an address from a base register value and an immediate offset, loads a halfword from memory, sign-extends it to form a 32-bit word, and writes it to a register. It can use offset, post-indexed, or pre-indexed addressing. For information about memory accesses see *Memory accesses* on page A8-13.

Encoding T1 ARMv6T2, ARMv7

LDRSH<c> <Rt>, [<Rn>, #<imm12>]

15	14	13	12	11	10	9	8	7	6	5	4	3	2	1	0	15	14	13	12	11	10	9	8	7	6	5	4	3	2	1	0
1	1	1	1	1	0	0	1	1	0	1	1	Rn				Rt				imm12											

```

if Rn == '1111' then SEE LDRSH (literal);
if Rt == '1111' then SEE "Unallocated memory hints";
t = UInt(Rt); n = UInt(Rn); imm32 = ZeroExtend(imm12, 32);
index = TRUE; add = TRUE; wback = FALSE;
if t == 13 then UNPREDICTABLE;
    
```

Encoding T2 ARMv6T2, ARMv7

LDRSH<c> <Rt>, [<Rn>, #-<imm8>]

LDRSH<c> <Rt>, [<Rn>], #+/-<imm8>

LDRSH<c> <Rt>, [<Rn>, #+/-<imm8>]!

15	14	13	12	11	10	9	8	7	6	5	4	3	2	1	0	15	14	13	12	11	10	9	8	7	6	5	4	3	2	1	0
1	1	1	1	1	0	0	1	0	0	1	1	Rn				Rt				1	P	U	W	imm8							

```

if Rn == '1111' then SEE LDRSH (literal);
if Rt == '1111' && P == '1' && U == '0' && W == '0' then SEE "Unallocated memory hints";
if P == '1' && U == '1' && W == '0' then SEE LDRSHT;
if P == '0' && W == '0' then UNDEFINED;
t = UInt(Rt); n = UInt(Rn); imm32 = ZeroExtend(imm8, 32);
index = (P == '1'); add = (U == '1'); wback = (W == '1');
if BadReg(t) || (wback && n == t) then UNPREDICTABLE;
    
```

Encoding A1 ARMv4*, ARMv5T*, ARMv6*, ARMv7

LDRSH<c> <Rt>, [<Rn>{, #+/-<imm8>}]

LDRSH<c> <Rt>, [<Rn>], #+/-<imm8>

LDRSH<c> <Rt>, [<Rn>, #+/-<imm8>]!

31	30	29	28	27	26	25	24	23	22	21	20	19	18	17	16	15	14	13	12	11	10	9	8	7	6	5	4	3	2	1	0
cond		0	0	0	P	U	1	W	1	Rn				Rt				imm4H				1	1	1	1	imm4L					

```

if Rn == '1111' then SEE LDRSH (literal);
if P == '0' && W == '1' then SEE LDRSHT;
t = UInt(Rt); n = UInt(Rn); imm32 = ZeroExtend(imm4H:imm4L, 32);
index = (P == '1'); add = (U == '1'); wback = (P == '0') || (W == '1');
if t == 15 || (wback && n == t) then UNPREDICTABLE;
    
```

Unallocated memory hints

See *Load halfword, memory hints* on page A6-26

Assembler syntax

LDRSH<c><q> <Rt>, [<Rn> {, #+/-<imm>}]	Offset: index==TRUE, wback==FALSE
LDRSH<c><q> <Rt>, [<Rn>, #+/-<imm>]!	Pre-indexed: index==TRUE, wback==TRUE
LDRSH<c><q> <Rt>, [<Rn>], #+/-<imm>	Post-indexed: index==FALSE, wback==TRUE

where:

<c><q>	See <i>Standard assembler syntax fields</i> on page A8-7.
<Rt>	The destination register.
<Rn>	The base register. The SP can be used. For PC use see <i>LDRSH (literal)</i> on page A8-170.
+/-	Is + or omitted to indicate that the immediate offset is added to the base register value (add == TRUE), or – to indicate that the offset is to be subtracted (add == FALSE). Different instructions are generated for #0 and #-0.
<imm>	The immediate offset used to form the address. Values are 0-4095 for encoding T1, and 0-255 for encoding T2 or A1. For the offset syntax, <imm> can be omitted, meaning an offset of 0.

The pre-UAL syntax LDR<c>SH is equivalent to LDRSH<c>.

Operation

```

if ConditionPassed() then
    EncodingSpecificOperations(); NullCheckIfThumbEE(n);
    offset_addr = if add then (R[n] + imm32) else (R[n] - imm32);
    address = if index then offset_addr else R[n];
    data = MemU[address,2];
    if wback then R[n] = offset_addr;
    if UnalignedSupport() || address<0> = '0' then
        R[t] = SignExtend(data, 32);
    else // Can only apply before ARMv7
        R[t] = bits(32) UNKNOWN;

```

Exceptions

Data Abort.

A8.6.83 LDRSH (literal)

Load Register Signed Halfword (literal) calculates an address from the PC value and an immediate offset, loads a halfword from memory, sign-extends it to form a 32-bit word, and writes it to a register. For information about memory accesses see *Memory accesses* on page A8-13.

Encoding T1 ARMv6T2, ARMv7

LDRSH<c> <Rt>, <label>

LDRSH<c> <Rt>, [PC, #-0]

Special case

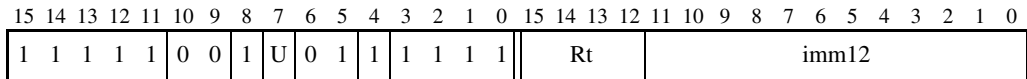

if Rt == '1111' then SEE "Unallocated memory hints";
 t = UInt(Rt); imm32 = ZeroExtend(imm12, 32); add = (U == '1');
 if t == 13 then UNPREDICTABLE;

Encoding A1 ARMv4*, ARMv5T*, ARMv6*, ARMv7

LDRSH<c> <Rt>, <label>

LDRSH<c> <Rt>, [PC, #-0]

Special case

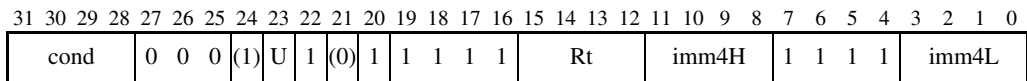

t = UInt(Rt); imm32 = ZeroExtend(imm4H:imm4L, 32); add = (U == '1');
 if t == 15 then UNPREDICTABLE;

Unallocated memory hints

See *Load halfword, memory hints* on page A6-26

Assembler syntax

LDRSH<c><q> <Rt>, <label> Normal form
 LDRSH<c><q> <Rt>, [PC, #+/-<imm>] Alternative form

where:

<c><q> See *Standard assembler syntax fields* on page A8-7.

<Rt> The destination register.

<label> The label of the literal data item that is to be loaded into <Rt>. The assembler calculates the required value of the offset from the `Align(PC,4)` value of the ADR instruction to this label. Permitted values of the offset are:

Encoding T1 any value in the range -4095 to 4095

Encoding A1 any value in the range -255 to 255.

If the offset is zero or positive, `imm32` is equal to the offset and `add == TRUE`.

If the offset is negative, `imm32` is equal to minus the offset and `add == FALSE`.

The alternative syntax permits the addition or subtraction of the offset and the immediate offset to be specified separately, including permitting a subtraction of 0 that cannot be specified using the normal syntax. For more information, see *Use of labels in UAL instruction syntax* on page A4-5.

The pre-UAL syntax `LDR<c>SH` is equivalent to `LDRSH<c>`.

Operation

```
if ConditionPassed() then
    EncodingSpecificOperations(); NullCheckIfThumbEE(15);
    base = Align(PC,4);
    address = if add then (base + imm32) else (base - imm32);
    data = MemU[address,2];
    if UnalignedSupport() || address<0> = '0' then
        R[t] = SignExtend(data, 32);
    else // Can only apply before ARMv7
        R[t] = bits(32) UNKNOWN;
```

Exceptions

Data Abort.

A8.6.84 LDRSH (register)

Load Register Signed Halfword (register) calculates an address from a base register value and an offset register value, loads a halfword from memory, sign-extends it to form a 32-bit word, and writes it to a register. The offset register value can be shifted left by 0, 1, 2, or 3 bits. For information about memory accesses see *Memory accesses* on page A8-13.

Encoding T1 ARMv4T, ARMv5T*, ARMv6*, ARMv7

LDRSH<c> <Rt>, [<Rn>, <Rm>]

15	14	13	12	11	10	9	8	7	6	5	4	3	2	1	0
0	1	0	1	1	1			Rm		Rn					Rt

```
if CurrentInstrSet() == InstrSet_ThumbEE then SEE "Modified operation in ThumbEE";
t = UInt(Rt); n = UInt(Rn); m = UInt(Rm);
index = TRUE; add = TRUE; wback = FALSE;
(shift_t, shift_n) = (SRTYPE_LSL, 0);
```

Encoding T2 ARMv6T2, ARMv7

LDRSH<c>.W <Rt>, [<Rn>, <Rm>{, LSL #<imm2>}]

15	14	13	12	11	10	9	8	7	6	5	4	3	2	1	0	15	14	13	12	11	10	9	8	7	6	5	4	3	2	1	0
1	1	1	1	1	0	0	1	0	0	1	1			Rn					Rt	0	0	0	0	0	0	imm2		Rm			

```
if Rn == '1111' then SEE LDRSH (literal);
if Rt == '1111' then SEE "Unallocated memory hints";
t = UInt(Rt); n = UInt(Rn); m = UInt(Rm);
index = TRUE; add = TRUE; wback = FALSE;
(shift_t, shift_n) = (SRTYPE_LSL, UInt(imm2));
if t == 13 || BadReg(m) then UNPREDICTABLE;
```

Encoding A1 ARMv4*, ARMv5T*, ARMv6*, ARMv7

LDRSH<c> <Rt>, [<Rn>, +/-<Rm>]{!}

LDRSH<c> <Rt>, [<Rn>], +/-<Rm>

31	30	29	28	27	26	25	24	23	22	21	20	19	18	17	16	15	14	13	12	11	10	9	8	7	6	5	4	3	2	1	0
cond		0	0	0	P	U	0	W	1					Rn					Rt	(0)	(0)	(0)	(0)	1	1	1	1			Rm	

```
if P == '0' && W == '1' then SEE LDRSHT;
t = UInt(Rt); n = UInt(Rn); m = UInt(Rm);
index = (P == '1'); add = (U == '1'); wback = (P == '0') || (W == '1');
(shift_t, shift_n) = (SRTYPE_LSL, 0);
if t == 15 || m == 15 then UNPREDICTABLE;
if wback && (n == 15 || n == t) then UNPREDICTABLE;
if ArchVersion() < 6 && wback && m == n then UNPREDICTABLE;
```

Unallocated memory hints

See *Load halfword, memory hints* on page A6-26

Modified operation in ThumbEE

See *LDRSH (register)* on page A9-11

Assembler syntax

LDRSH<c><q> <Rt>, [<Rn>, <Rm>{, LSL #<imm>}]	Offset: index==TRUE, wback==FALSE
LDRSH<c><q> <Rt>, [<Rn>, +/-<Rm>]	Offset: index==TRUE, wback==FALSE
LDRSH<c><q> <Rt>, [<Rn>, +/-<Rm>!]	Pre-indexed: index==TRUE, wback==TRUE
LDRSH<c><q> <Rt>, [<Rn>], +/-<Rm>	Post-indexed: index==FALSE, wback==TRUE

where:

<c><q>	See <i>Standard assembler syntax fields</i> on page A8-7.
<Rt>	The destination register.
<Rn>	The base register. The SP can be used. The PC can be used only in the ARM instruction set.
+/-	Is + or omitted if the optionally shifted value of <Rm> is to be added to the base register value (add == TRUE), or – if it is to be subtracted (permitted in ARM code only, add == FALSE).
<Rm>	Contains the offset that is optionally left shifted and added to the value of <Rn> to form the address.
<imm>	If present, the size of the left shift to apply to the value from <Rm>, in the range 1-3. Only encoding T2 is permitted, and <imm> is encoded in imm2. If absent, no shift is specified and all encodings are permitted. In encoding T2, imm2 is encoded as 0b00.

The pre-UAL syntax LDR<c>SH is equivalent to LDRSH<c>.

Operation

```

if ConditionPassed() then
    EncodingSpecificOperations(); NullCheckIFThumbEE(n);
    offset = Shift(R[m], shift_t, shift_n, APSR.C);
    offset_addr = if add then (R[n] + offset) else (R[n] - offset);
    address = if index then offset_addr else R[n];
    data = MemU[address,2];
    if wback then R[n] = offset_addr;
    if UnalignedSupport() || address<0> = '0' then
        R[t] = SignExtend(data, 32);
    else // Can only apply before ARMv7
        R[t] = bits(32) UNKNOWN;

```

Exceptions

Data Abort.

A8.6.85 LDRSHT

Load Register Signed Halfword Unprivileged loads a halfword from memory, sign-extends it to form a 32-bit word, and writes it to a register. For information about memory accesses see *Memory accesses* on page A8-13.

The memory access is restricted as if the processor were running in User mode. (This makes no difference if the processor is actually running in User mode.)

The Thumb instruction uses an offset addressing mode, that calculates the address used for the memory access from a base register value and an immediate offset, and leaves the base register unchanged.

The ARM instruction uses a post-indexed addressing mode, that uses a base register value as the address for the memory access, and calculates a new address from a base register value and an offset and writes it back to the base register. The offset can be an immediate value or a register value.

Encoding T1 ARMv6T2, ARMv7

LDRSHT<c> <Rt>, [<Rn>, #<imm8>]

15	14	13	12	11	10	9	8	7	6	5	4	3	2	1	0	15	14	13	12	11	10	9	8	7	6	5	4	3	2	1	0
1	1	1	1	1	0	0	1	0	0	1	1	Rn				Rt				1	1	1	0	imm8							

```
if Rn == '1111' then SEE LDRSH (literal);
t = UInt(Rt); n = UInt(Rn); postindex = FALSE; add = TRUE;
register_form = FALSE; imm32 = ZeroExtend(imm8, 32);
if BadReg(t) then UNPREDICTABLE;
```

Encoding A1 ARMv6T2, ARMv7

LDRSHT<c> <Rt>, [<Rn>] {, #+/-<imm8>}

31	30	29	28	27	26	25	24	23	22	21	20	19	18	17	16	15	14	13	12	11	10	9	8	7	6	5	4	3	2	1	0
cond		0	0	0	0	U	1	1	1	Rn				Rt				imm4H				1	1	1	1	imm4L					

```
t = UInt(Rt); n = UInt(Rn); postindex = TRUE; add = (U == '1');
register_form = FALSE; imm32 = ZeroExtend(imm4H:imm4L, 32);
if t == 15 || n == 15 || n == t then UNPREDICTABLE;
```

Encoding A2 ARMv6T2, ARMv7

LDRSHT<c> <Rt>, [<Rn>], +/-<Rm>

31	30	29	28	27	26	25	24	23	22	21	20	19	18	17	16	15	14	13	12	11	10	9	8	7	6	5	4	3	2	1	0		
cond		0	0	0	0	U	0	1	1	Rn				Rt				(0)	(0)	(0)	(0)	1				1	1	1	Rm				

```
t = UInt(Rt); n = UInt(Rn); m = UInt(Rm); postindex = TRUE; add = (U == '1');
register_form = TRUE;
if t == 15 || n == 15 || n == t || m == 15 then UNPREDICTABLE;
```

Assembler syntax

LDRSHT<C><Q> <Rt>, [<Rn> {, #<imm>}]	Offset: Thumb only
LDRSHT<C><Q> <Rt>, [<Rn>] {, #+/-<imm>}	Post-indexed: ARM only
LDRSHT<C><Q> <Rt>, [<Rn>], +/-<Rm>	Post-indexed: ARM only

where:

<C><Q>	See <i>Standard assembler syntax fields</i> on page A8-7.
<Rt>	The destination register.
<Rn>	The base register. The SP can be used.
+/-	Is + or omitted if <imm> or the optionally shifted value of <Rm> is to be added to the base register value (add == TRUE), or – if it is to be subtracted (permitted in ARM code only, add == FALSE).
<imm>	The immediate offset applied to the value of <Rn>. Any value in the range 0-255 is permitted. <imm> can be omitted, meaning an offset of 0.
<Rm>	Contains the offset that is applied to the value of <Rn> to form the address.

Operation

```

if ConditionPassed() then
    EncodingSpecificOperations(); NullCheckIfThumbEE(n);
    offset = if register_form then R[m] else imm32;
    offset_addr = if add then (R[n] + offset) else (R[n] - offset);
    address = if postindex then R[n] else offset_addr;
    data = MemU_unpriv[address,2];
    if postindex then R[n] = offset_addr;
    if UnalignedSupport() || address<0> = '0' then
        R[t] = SignExtend(data, 32);
    else // Can only apply before ARMv7
        R[t] = bits(32) UNKNOWN;

```

Exceptions

Data Abort.

A8.6.86 LDRT

Load Register Unprivileged loads a word from memory, and writes it to a register. For information about memory accesses see *Memory accesses* on page A8-13.

The memory access is restricted as if the processor were running in User mode. (This makes no difference if the processor is actually running in User mode.)

The Thumb instruction uses an offset addressing mode, that calculates the address used for the memory access from a base register value and an immediate offset, and leaves the base register unchanged.

The ARM instruction uses a post-indexed addressing mode, that uses a base register value as the address for the memory access, and calculates a new address from a base register value and an offset and writes it back to the base register. The offset can be an immediate value or an optionally-shifted register value.

Encoding T1 ARMv6T2, ARMv7

LDRT<c> <Rt>, [<Rn>, #<imm8>]

15	14	13	12	11	10	9	8	7	6	5	4	3	2	1	0	15	14	13	12	11	10	9	8	7	6	5	4	3	2	1	0
1	1	1	1	1	0	0	0	0	1	0	1	Rn				Rt				1	1	1	0	imm8							

```
if Rn == '1111' then SEE LDR (literal);
t = UInt(Rt); n = UInt(Rn); postindex = FALSE; add = TRUE;
register_form = FALSE; imm32 = ZeroExtend(imm8, 32);
if BadReg(t) then UNPREDICTABLE;
```

Encoding A1 ARMv4*, ARMv5T*, ARMv6*, ARMv7

LDRT<c> <Rt>, [<Rn>] {, #+/-<imm12>}

31	30	29	28	27	26	25	24	23	22	21	20	19	18	17	16	15	14	13	12	11	10	9	8	7	6	5	4	3	2	1	0
cond		0	1	0	0	U	0	1	1	Rn				Rt				imm12													

```
t = UInt(Rt); n = UInt(Rn); postindex = TRUE; add = (U == '1');
register_form = FALSE; imm32 = ZeroExtend(imm12, 32);
if t == 15 || n == 15 || n == t then UNPREDICTABLE;
```

Encoding A2 ARMv4*, ARMv5T*, ARMv6*, ARMv7

LDRT<c> <Rt>, [<Rn>], +/-<Rm>{, <shift>}

31	30	29	28	27	26	25	24	23	22	21	20	19	18	17	16	15	14	13	12	11	10	9	8	7	6	5	4	3	2	1	0
cond		0	1	1	0	U	0	1	1	Rn				Rt				imm5			type	0	Rm								

```
t = UInt(Rt); n = UInt(Rn); m = UInt(Rm); postindex = TRUE; add = (U == '1');
register_form = TRUE; (shift_t, shift_n) = DecodeImmShift(type, imm5);
if t == 15 || n == 15 || n == t || m == 15 then UNPREDICTABLE;
if ArchVersion() < 6 && m == n then UNPREDICTABLE;
```

Assembler syntax

LDRT<c><q> <Rt>, [<Rn> {, #<imm>}]	Offset: Thumb only
LDRT<c><q> <Rt>, [<Rn>] {, #+/-<imm>}	Post-indexed: ARM only
LDRT<c><q> <Rt>, [<Rn>], +/-<Rm> {, <shift>}	Post-indexed: ARM only

where:

<c><q>	See <i>Standard assembler syntax fields</i> on page A8-7.
<Rt>	The destination register.
<Rn>	The base register. The SP can be used.
+/-	Is + or omitted if <imm> or the optionally shifted value of <Rm> is to be added to the base register value (add == TRUE), or – if it is to be subtracted (permitted in ARM code only, add == FALSE).
<imm>	The immediate offset applied to the value of <Rn>. Values are 0-255 for encoding T1, and 0-4095 for encoding A1. <imm> can be omitted, meaning an offset of 0.
<Rm>	Contains the offset that is optionally shifted and applied to the value of <Rn> to form the address.
<shift>	The shift to apply to the value read from <Rm>. If omitted, no shift is applied. <i>Shifts applied to a register</i> on page A8-10 describes the shifts and how they are encoded.

The pre-UAL syntax LDR<c>T is equivalent to LDRT<c>.

Operation

```

if ConditionPassed() then
    EncodingSpecificOperations(); NullCheckIfThumbEE(n);
    offset = if register_form then Shift(R[m], shift_t, shift_n, APSR.C) else imm32;
    offset_addr = if add then (R[n] + offset) else (R[n] - offset);
    address = if postindex then R[n] else offset_addr;
    data = MemU_unpriv[address,4];
    if postindex then R[n] = offset_addr;
if t == 15 then // Only possible for encodings A1 and A2
    if address<1:0> == '00' then LoadWritePC(data); else UNPREDICTABLE;
    if UnalignedSupport() || address<1:0> = '00' then
        R[t] = data;
    else // Can only apply before ARMv7
        if CurrentInstrSet() == InstrSet_ARM then
            R[t] = ROR(data, 8*UInt(address<1:0>));
        else
            R[t] = bits(32) UNKNOWN;

```

Exceptions

Data Abort.

A8.6.87 LEAVEX

LEAVEX causes a change from ThumbEE to Thumb state, or has no effect in Thumb state. For details see *ENTERX*, *LEAVEX* on page A9-7.

A8.6.88 LSL (immediate)

Logical Shift Left (immediate) shifts a register value left by an immediate number of bits, shifting in zeros, and writes the result to the destination register. It can optionally update the condition flags based on the result.

Encoding T1 ARMv4T, ARMv5T*, ARMv6*, ARMv7

LSLS <Rd>, <Rm>, #<imm5>

Outside IT block.

LSL<c> <Rd>, <Rm>, #<imm5>

Inside IT block.

15	14	13	12	11	10	9	8	7	6	5	4	3	2	1	0
0	0	0	0	0	imm5					Rm	Rd				

```
if imm5 == '00000' then SEE MOV (register);
d = UInt(Rd); m = UInt(Rm); setflags = !InITBlock();
(-, shift_n) = DecodeImmShift('00', imm5);
```

Encoding T2 ARMv6T2, ARMv7

LSL{S}<c>.W <Rd>, <Rm>, #<imm5>

15	14	13	12	11	10	9	8	7	6	5	4	3	2	1	0	15	14	13	12	11	10	9	8	7	6	5	4	3	2	1	0
1	1	1	0	1	0	1	0	0	1	0	S	1	1	1	1	(0)	imm3			Rd			imm2		0	0	Rm				

```
if (imm3:imm2) == '00000' then SEE MOV (register);
d = UInt(Rd); m = UInt(Rm); setflags = (S == '1');
(-, shift_n) = DecodeImmShift('00', imm3:imm2);
if BadReg(d) || BadReg(m) then UNPREDICTABLE;
```

Encoding A1 ARMv4*, ARMv5T*, ARMv6*, ARMv7

LSL{S}<c> <Rd>, <Rm>, #<imm5>

31	30	29	28	27	26	25	24	23	22	21	20	19	18	17	16	15	14	13	12	11	10	9	8	7	6	5	4	3	2	1	0
cond			0	0	0	1	1	0	1	S	(0)	(0)	(0)	(0)	Rd			imm5			0			0	0	Rm					

```
if imm5 == '00000' then SEE MOV (register);
d = UInt(Rd); m = UInt(Rm); setflags = (S == '1');
(-, shift_n) = DecodeImmShift('00', imm5);
```

Assembler syntax

```
LSL{S}<C><Q> {<Rd>,<Rm>,<imm5>
```

where:

- S If S is present, the instruction updates the flags. Otherwise, the flags are not updated.
- <C><Q> See *Standard assembler syntax fields* on page A8-7.
- <Rd> The destination register.
- <Rm> The first operand register.
- <imm5> The shift amount, in the range 1 to 31. See *Shifts applied to a register* on page A8-10.

Operation

```
if ConditionPassed() then
    EncodingSpecificOperations();
    (result, carry) = Shift_C(R[m], SRTYPE_LSL, shift_n, APSR.C);
    if d == 15 then // Can only occur for ARM encoding
        ALUWritePC(result); // setflags is always FALSE here
    else
        R[d] = result;
        if setflags then
            APSR.N = result<31>;
            APSR.Z = IsZeroBit(result);
            APSR.C = carry;
            // APSR.V unchanged
```

Exceptions

None.

A8.6.89 LSL (register)

Logical Shift Left (register) shifts a register value left by a variable number of bits, shifting in zeros, and writes the result to the destination register. The variable number of bits is read from the bottom byte of a register. It can optionally update the condition flags based on the result.

Encoding T1 ARMv4T, ARMv5T*, ARMv6*, ARMv7

LSLS <Rdn>, <Rm> Outside IT block.

LSL<c> <Rdn>, <Rm> Inside IT block.

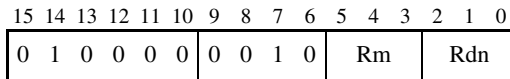

d = UInt(Rdn); n = UInt(Rdn); m = UInt(Rm); setflags = !InITBlock();

Encoding T2 ARMv6T2, ARMv7

LSL{S}<c>.W <Rd>, <Rn>, <Rm>

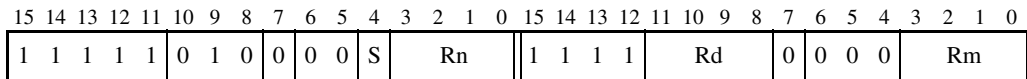

d = UInt(Rd); n = UInt(Rn); m = UInt(Rm); setflags = (S == '1');
 if BadReg(d) || BadReg(n) || BadReg(m) then UNPREDICTABLE;

Encoding A1 ARMv4*, ARMv5T*, ARMv6*, ARMv7

LSL{S}<c> <Rd>, <Rn>, <Rm>

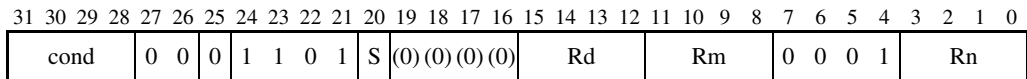

d = UInt(Rd); n = UInt(Rn); m = UInt(Rm); setflags = (S == '1');
 if d == 15 || n == 15 || m == 15 then UNPREDICTABLE;

Assembler syntax

```
LSL{S}<C><Q> {<Rd>}, <Rn>, <Rm>
```

where:

- S If S is present, the instruction updates the flags. Otherwise, the flags are not updated.
- <C><Q> See *Standard assembler syntax fields* on page A8-7.
- <Rd> The destination register.
- <Rn> The first operand register.
- <Rm> The register whose bottom byte contains the amount to shift by.

Operation

```
if ConditionPassed() then
    EncodingSpecificOperations();
    shift_n = UInt(R[m]<7:0>);
    (result, carry) = Shift_C(R[n], SRTYPE_LSL, shift_n, APSR.C);
    R[d] = result;
    if setflags then
        APSR.N = result<31>;
        APSR.Z = IsZeroBit(result);
        APSR.C = carry;
        // APSR.V unchanged
```

Exceptions

None.

A8.6.90 LSR (immediate)

Logical Shift Right (immediate) shifts a register value right by an immediate number of bits, shifting in zeros, and writes the result to the destination register. It can optionally update the condition flags based on the result.

Encoding T1 ARMv4T, ARMv5T*, ARMv6*, ARMv7

LSRS <Rd>, <Rm>, #<imm> Outside IT block.

LSR<c> <Rd>, <Rm>, #<imm> Inside IT block.

15	14	13	12	11	10	9	8	7	6	5	4	3	2	1	0
0	0	0	0	1	imm5					Rm			Rd		

```
d = UInt(Rd); m = UInt(Rm); setflags = !InITBlock();
(-, shift_n) = DecodeImmShift('01', imm5);
```

Encoding T2 ARMv6T2, ARMv7

LSR{S}<c>.W <Rd>, <Rm>, #<imm>

15	14	13	12	11	10	9	8	7	6	5	4	3	2	1	0	15	14	13	12	11	10	9	8	7	6	5	4	3	2	1	0
1	1	1	0	1	0	1	0	0	0	1	0	S	1	1	1	1	(0)	imm3			Rd			imm2		0	1	Rm			

```
d = UInt(Rd); m = UInt(Rm); setflags = (S == '1');
(-, shift_n) = DecodeImmShift('01', imm3:imm2);
if BadReg(d) || BadReg(m) then UNPREDICTABLE;
```

Encoding A1 ARMv4*, ARMv5T*, ARMv6*, ARMv7

LSR{S}<c> <Rd>, <Rm>, #<imm>

31	30	29	28	27	26	25	24	23	22	21	20	19	18	17	16	15	14	13	12	11	10	9	8	7	6	5	4	3	2	1	0
cond			0	0	0	1	1	0	1	S	(0)	(0)	(0)	(0)	Rd			imm5			0	1	0	Rm							

```
d = UInt(Rd); m = UInt(Rm); setflags = (S == '1');
(-, shift_n) = DecodeImmShift('01', imm5);
```

Assembler syntax

LSR{S}<C><Q> {<Rd>}, <Rm>, #<imm>

where:

- S If S is present, the instruction updates the flags. Otherwise, the flags are not updated.
- <C><Q> See *Standard assembler syntax fields* on page A8-7.
- <Rd> The destination register.
- <Rm> The first operand register.
- <imm> The shift amount, in the range 1 to 32. See *Shifts applied to a register* on page A8-10.

Operation

```

if ConditionPassed() then
    EncodingSpecificOperations();
    (result, carry) = Shift_C(R[m], SRTYPE_LSR, shift_n, APSR.C);
    if d == 15 then // Can only occur for ARM encoding
        ALUWritePC(result); // setflags is always FALSE here
    else
        R[d] = result;
        if setflags then
            APSR.N = result<31>;
            APSR.Z = IsZeroBit(result);
            APSR.C = carry;
            // APSR.V unchanged

```

Exceptions

None.

A8.6.91 LSR (register)

Logical Shift Right (register) shifts a register value right by a variable number of bits, shifting in zeros, and writes the result to the destination register. The variable number of bits is read from the bottom byte of a register. It can optionally update the condition flags based on the result.

Encoding T1 ARMv4T, ARMv5T*, ARMv6*, ARMv7

LSRS <Rdn>, <Rm> Outside IT block.
 LSR<c> <Rdn>, <Rm> Inside IT block.

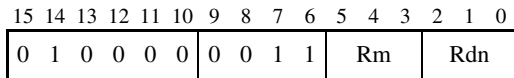

d = UInt(Rdn); n = UInt(Rdn); m = UInt(Rm); setflags = !InITBlock();

Encoding T2 ARMv6T2, ARMv7

LSR{S}<c>.W <Rd>, <Rn>, <Rm>

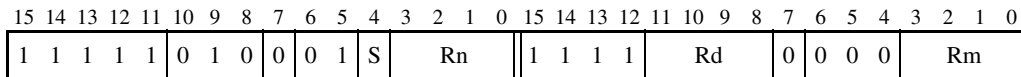

d = UInt(Rd); n = UInt(Rn); m = UInt(Rm); setflags = (S == '1');
 if BadReg(d) || BadReg(n) || BadReg(m) then UNPREDICTABLE;

Encoding A1 ARMv4*, ARMv5T*, ARMv6*, ARMv7

LSR{S}<c> <Rd>, <Rn>, <Rm>

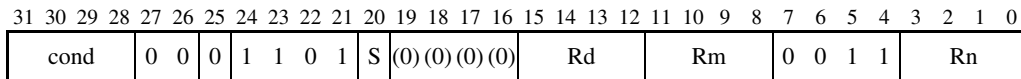

d = UInt(Rd); n = UInt(Rn); m = UInt(Rm); setflags = (S == '1');
 if d == 15 || n == 15 || m == 15 then UNPREDICTABLE;

Assembler syntax

```
LSR{S}<C><Q> {<Rd>}, <Rn>, <Rm>
```

where:

- S If S is present, the instruction updates the flags. Otherwise, the flags are not updated.
- <C><Q> See *Standard assembler syntax fields* on page A8-7.
- <Rd> The destination register.
- <Rn> The first operand register.
- <Rm> The register whose bottom byte contains the amount to shift by.

Operation

```
if ConditionPassed() then
    EncodingSpecificOperations();
    shift_n = UInt(R[m]<7:0>);
    (result, carry) = Shift_C(R[n], SRTYPE_LSR, shift_n, APSR.C);
    R[d] = result;
    if setflags then
        APSR.N = result<31>;
        APSR.Z = IsZeroBit(result);
        APSR.C = carry;
        // APSR.V unchanged
```

Exceptions

None.

A8.6.92 MCR, MCR2

Move to Coprocessor from ARM core register passes the value of an ARM core register to a coprocessor. If no coprocessor can execute the instruction, an Undefined Instruction exception is generated.

This is a generic coprocessor instruction. Some of the fields have no functionality defined by the architecture and are free for use by the coprocessor instruction set designer. These fields are the `opc1`, `opc2`, `CRn`, and `CRm` fields.

For more information about the coprocessors see *Coprocessor support* on page A2-68.

Encoding T1 / A1 ARMv6T2, ARMv7 for encoding T1
 ARMv4*, ARMv5T*, ARMv6*, ARMv7 for encoding A1

MCR<c> <coproc>, <opc1>, <Rt>, <CRn>, <CRm>{, <opc2>}

15	14	13	12	11	10	9	8	7	6	5	4	3	2	1	0	15	14	13	12	11	10	9	8	7	6	5	4	3	2	1	0
1	1	1	0	1	1	1	0	opc1	0	CRn		Rt	coproc	opc2	1	CRm															
31	30	29	28	27	26	25	24	23	22	21	20	19	18	17	16	15	14	13	12	11	10	9	8	7	6	5	4	3	2	1	0
cond	1	1	1	0	opc1	0	CRn		Rt	coproc	opc2	1	CRm																		

```
if coproc == '101x' then SEE "Advanced SIMD and VFP";
t = UInt(Rt); cp = UInt(coproc);
if t == 15 || (t == 13 && (CurrentInstrSet() != InstrSet_ARM)) then UNPREDICTABLE;
```

Encoding T2 / A2 ARMv6T2, ARMv7 for encoding T2
 ARMv5T*, ARMv6*, ARMv7 for encoding A2

MCR2<c> <coproc>, <opc1>, <Rt>, <CRn>, <CRm>{, <opc2>}

15	14	13	12	11	10	9	8	7	6	5	4	3	2	1	0	15	14	13	12	11	10	9	8	7	6	5	4	3	2	1	0
1	1	1	1	1	1	0	opc1	0	CRn		Rt	coproc	opc2	1	CRm																
31	30	29	28	27	26	25	24	23	22	21	20	19	18	17	16	15	14	13	12	11	10	9	8	7	6	5	4	3	2	1	0
1	1	1	1	1	1	0	opc1	0	CRn		Rt	coproc	opc2	1	CRm																

```
t = UInt(Rt); cp = UInt(coproc);
if t == 15 || (t == 13 && (CurrentInstrSet() != InstrSet_ARM)) then UNPREDICTABLE;
```

Advanced SIMD and VFP See 8, 16, and 32-bit transfer between ARM core and extension registers on page A7-31

Assembler syntax

MCR{2}<c><q> <coproc>, #<opc1>, <Rt>, <CRn>, <CRm>{, #<opc2>}

where:

- 2 If specified, selects encoding T2 / A2. If omitted, selects encoding T1 / A1.
- <c><q> See *Standard assembler syntax fields* on page A8-7. An ARM MCR2 instruction must be unconditional.
- <coproc> The name of the coprocessor. The standard generic coprocessor names are p0, p1, ..., p15.
- <opc1> Is a coprocessor-specific opcode in the range 0 to 7.
- <Rt> Is the ARM core register whose value is transferred to the coprocessor.
- <CRn> Is the destination coprocessor register.
- <CRm> Is an additional destination coprocessor register.
- <opc2> Is a coprocessor-specific opcode in the range 0-7. If omitted, <opc2> is assumed to be 0.

Operation

```

if ConditionPassed() then
    EncodingSpecificOperations();
    if !Cproc_Accepted(cp, ThisInstr()) then
        GenerateCoproprocessorException();
    else
        Cproc_SendOneWord(R[t], cp, ThisInstr());

```

Exceptions

Undefined Instruction.

A8.6.93 MCRR, MCRR2

Move to Coprocessor from two ARM core registers passes the values of two ARM core registers to a coprocessor. If no coprocessor can execute the instruction, an Undefined Instruction exception is generated.

This is a generic coprocessor instruction. The *opc1* and *CRm* fields have no functionality defined by the architecture and are free for use by the coprocessor instruction set designer.

For more information about the coprocessors see *Coprocessor support* on page A2-68.

Encoding T1 / A1 ARMv6T2, ARMv7 for encoding T1
 ARMv5TE*, ARMv6*, ARMv7 for encoding A1

MCRR<c> <coproc>, <opc1>, <Rt>, <Rt2>, <CRm>

15	14	13	12	11	10	9	8	7	6	5	4	3	2	1	0	15	14	13	12	11	10	9	8	7	6	5	4	3	2	1	0
1	1	1	0	1	1	0	0	0	1	0	0	Rt2				Rt				coproc				opc1				CRm			
31	30	29	28	27	26	25	24	23	22	21	20	19	18	17	16	15	14	13	12	11	10	9	8	7	6	5	4	3	2	1	0
cond				1	1	0	0	0	1	0	0	Rt2				Rt				coproc				opc1				CRm			

```
if coproc == '101x' then SEE "Advanced SIMD and VFP";
t = UInt(Rt); t2 = UInt(Rt2); cp = UInt(coproc);
if t == 15 || t2 == 15 then UNPREDICTABLE;
if (t == 13 || t2 == 13) && (CurrentInstrSet() != InstrSet_ARM) then UNPREDICTABLE;
```

Encoding T2 / A2 ARMv6T2, ARMv7 for encoding T2
 ARMv6*, ARMv7 for encoding A2

MCRR2<c> <coproc>, <opc1>, <Rt>, <Rt2>, <CRm>

15	14	13	12	11	10	9	8	7	6	5	4	3	2	1	0	15	14	13	12	11	10	9	8	7	6	5	4	3	2	1	0
1	1	1	1	1	1	0	0	0	1	0	0	Rt2				Rt				coproc				opc1				CRm			
31	30	29	28	27	26	25	24	23	22	21	20	19	18	17	16	15	14	13	12	11	10	9	8	7	6	5	4	3	2	1	0
1	1	1	1	1	1	0	0	0	1	0	0	Rt2				Rt				coproc				opc1				CRm			

```
t = UInt(Rt); t2 = UInt(Rt2); cp = UInt(coproc);
if t == 15 || t2 == 15 then UNPREDICTABLE;
if (t == 13 || t2 == 13) && (CurrentInstrSet() != InstrSet_ARM) then UNPREDICTABLE;
```

Advanced SIMD and VFP See *64-bit transfers between ARM core and extension registers* on page A7-32

Assembler syntax

```
MCRR{2}<c><q> <coproc>, #<opc1>, <Rt>, <Rt2>, <CRm>
```

where:

2	If specified, selects encoding T2 / A2. If omitted, selects encoding T1 / A1.
<c><q>	See <i>Standard assembler syntax fields</i> on page A8-7. An ARM MCRR2 instruction must be unconditional.
<coproc>	The name of the coprocessor. The standard generic coprocessor names are p0, p1, ..., p15.
<opc1>	Is a coprocessor-specific opcode in the range 0 to 15.
<Rt>	Is the first ARM core register whose value is transferred to the coprocessor.
<Rt2>	Is the second ARM core register whose value is transferred to the coprocessor.
<CRm>	Is the destination coprocessor register.

Operation

```
if ConditionPassed() then
    EncodingSpecificOperations();
    if !Cproc_Accepted(cp, ThisInstr()) then
        GenerateCoproprocessorException();
    else
        Cproc_SendTwoWords(R[t], R[t2], cp, ThisInstr());
```

Exceptions

Undefined Instruction.

A8.6.94 MLA

Multiply Accumulate multiplies two register values, and adds a third register value. The least significant 32 bits of the result are written to the destination register. These 32 bits do not depend on whether the source register values are considered to be signed values or unsigned values.

In ARM code, the condition flags can optionally be updated based on the result. Use of this option adversely affects performance on many processor implementations.

Encoding T1 ARMv6T2, ARMv7

MLA<c> <Rd>, <Rn>, <Rm>, <Ra>

15	14	13	12	11	10	9	8	7	6	5	4	3	2	1	0	15	14	13	12	11	10	9	8	7	6	5	4	3	2	1	0				
1	1	1	1	1	0	1	1	0	0	0	0	Rn			Ra			Rd			0			0			0			0			Rm		

```

if Ra == '1111' then SEE MUL;
d = UInt(Rd); n = UInt(Rn); m = UInt(Rm); a = UInt(Ra); setflags = FALSE;
if BadReg(d) || BadReg(n) || BadReg(m) || a == 13 then UNPREDICTABLE;
    
```

Encoding A1 ARMv4*, ARMv5T*, ARMv6*, ARMv7

MLA{S}<c> <Rd>, <Rn>, <Rm>, <Ra>

31	30	29	28	27	26	25	24	23	22	21	20	19	18	17	16	15	14	13	12	11	10	9	8	7	6	5	4	3	2	1	0																			
cond		0				0				0				0				0				1				S	Rd			Ra			Rm			1			0			0			1			Rn		

```

d = UInt(Rd); n = UInt(Rn); m = UInt(Rm); a = UInt(Ra); setflags = (S == '1');
if d == 15 || n == 15 || m == 15 || a == 15 then UNPREDICTABLE;
if ArchVersion() < 6 && d == n then UNPREDICTABLE;
    
```

Assembler syntax

MLA{S}<C><Q> <Rd>, <Rn>, <Rm>, <Ra>

where:

- S If S is present, the instruction updates the flags. Otherwise, the flags are not updated.
S can be specified only for the ARM instruction set.
- <C><Q> See *Standard assembler syntax fields* on page A8-7.
- <Rd> The destination register.
- <Rn> The first operand register.
- <Rm> The second operand register.
- <Ra> The register containing the accumulate value.

The pre-UAL syntax MLA<C>S is equivalent to MLAS<C>.

Operation

```
if ConditionPassed() then
    EncodingSpecificOperations();
    operand1 = SInt(R[n]); // operand1 = UInt(R[n]) produces the same final results
    operand2 = SInt(R[m]); // operand2 = UInt(R[m]) produces the same final results
    addend = SInt(R[a]); // addend = UInt(R[a]) produces the same final results
    result = operand1 * operand2 + addend;
    R[d] = result<31:0>;
    if setflags then
        APSR.N = result<31>;
        APSR.Z = IsZeroBit(result);
        if ArchVersion() == 4 then
            APSR.C = bit UNKNOWN;
        // else APSR.C unchanged
        // APSR.V always unchanged
```

Exceptions

None.

A8.6.95 MLS

Multiply and Subtract multiplies two register values, and subtracts the product from a third register value. The least significant 32 bits of the result are written to the destination register. These 32 bits do not depend on whether the source register values are considered to be signed values or unsigned values.

Encoding T1 ARMv6T2, ARMv7

MLS<c> <Rd>, <Rn>, <Rm>, <Ra>

15	14	13	12	11	10	9	8	7	6	5	4	3	2	1	0	15	14	13	12	11	10	9	8	7	6	5	4	3	2	1	0
1	1	1	1	1	0	1	1	0	0	0	0	Rn				Ra				Rd				0	0	0	1	Rm			

d = UInt(Rd); n = UInt(Rn); m = UInt(Rm); a = UInt(Ra);
 if BadReg(d) || BadReg(n) || BadReg(m) || BadReg(a) then UNPREDICTABLE;

Encoding A1 ARMv6T2, ARMv7

MLS<c> <Rd>, <Rn>, <Rm>, <Ra>

31	30	29	28	27	26	25	24	23	22	21	20	19	18	17	16	15	14	13	12	11	10	9	8	7	6	5	4	3	2	1	0
cond		0	0	0	0	0	1	1	0	Rd				Ra				Rm				1	0	0	1	Rn					

d = UInt(Rd); n = UInt(Rn); m = UInt(Rm); a = UInt(Ra);
 if d == 15 || n == 15 || m == 15 || a == 15 then UNPREDICTABLE;

Assembler syntax

MLS<c><q> <Rd>, <Rn>, <Rm>, <Ra>

where:

<c><q> See *Standard assembler syntax fields* on page A8-7.

<Rd> The destination register.

<Rn> The first operand register.

<Rm> The second operand register.

<Ra> The register containing the accumulate value.

Operation

```
if ConditionPassed() then
    EncodingSpecificOperations();
    operand1 = SInt(R[n]); // operand1 = UInt(R[n]) produces the same final results
    operand2 = SInt(R[m]); // operand2 = UInt(R[m]) produces the same final results
    addend = SInt(R[a]); // addend = UInt(R[a]) produces the same final results
    result = addend - operand1 * operand2;
    R[d] = result<31:0>;
```

Exceptions

None.

A8.6.96 MOV (immediate)

Move (immediate) writes an immediate value to the destination register. It can optionally update the condition flags based on the value.

Encoding T1 ARMv4T, ARMv5T*, ARMv6*, ARMv7
 MOV<S> <Rd>, #<imm8> Outside IT block.
 MOV<C> <Rd>, #<imm8> Inside IT block.

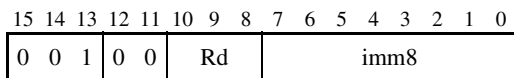

d = UInt(Rd); setflags = !InITBlock(); imm32 = ZeroExtend(imm8, 32); carry = APSR.C;

Encoding T2 ARMv6T2, ARMv7
 MOV{S}<C>.W <Rd>, #<const>

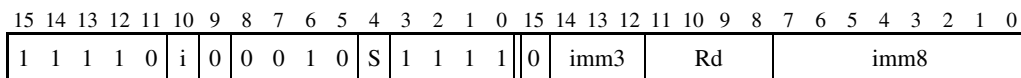

d = UInt(Rd); setflags = (S == '1'); (imm32, carry) = ThumbExpandImm_C(i:imm3:imm8, APSR.C);
 if BadReg(d) then UNPREDICTABLE;

Encoding T3 ARMv6T2, ARMv7
 MOVW<C> <Rd>, #<imm16>

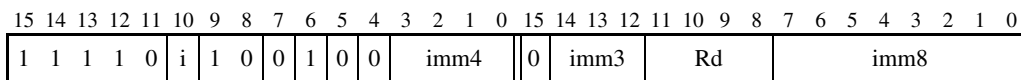

d = UInt(Rd); setflags = FALSE; imm32 = ZeroExtend(imm4:i:imm3:imm8, 32);
 if BadReg(d) then UNPREDICTABLE;

Encoding A1 ARMv4*, ARMv5T*, ARMv6*, ARMv7
 MOV{S}<C> <Rd>, #<const>

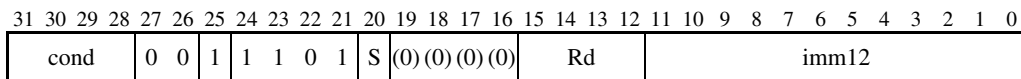

if Rd == '1111' && S == '1' then SEE SUBS PC, LR and related instructions;
 d = UInt(Rd); setflags = (S == '1'); (imm32, carry) = ARMEExpandImm_C(imm12, APSR.C);

Encoding A2 ARMv6T2, ARMv7
 MOVW<C> <Rd>, #<imm16>

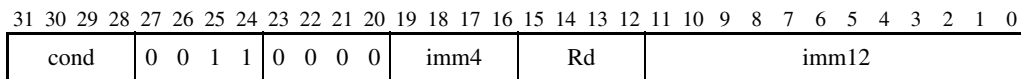

d = UInt(Rd); setflags = FALSE; imm32 = ZeroExtend(imm4:imm12, 32);
 if d == 15 then UNPREDICTABLE;

Assembler syntax

MOV{S}<C><Q> <Rd>, #<const> All encodings permitted
 MOVW<C><Q> <Rd>, #<const> Only encoding T3 or A2 permitted

where:

S If S is present, the instruction updates the flags. Otherwise, the flags are not updated.

<C><Q> See *Standard assembler syntax fields* on page A8-7.

<Rd> The destination register [1](#).

<const> The immediate value to be placed in <Rd>. The range of values is 0-255 for encoding T1 and 0-65535 for encoding T3 or A2. See *Modified immediate constants in Thumb instructions* on page A6-17 or *Modified immediate constants in ARM instructions* on page A5-9 for the range of values for encoding T2 or A1.

When both 32-bit encodings are available for an instruction, encoding T2 or A1 is preferred to encoding T3 or A2 (if encoding T3 or A2 is required, use the MOVW syntax).

The pre-UAL syntax MOV<C>S is equivalent to MOVS<C>.

Operation

```
if ConditionPassed() then
    EncodingSpecificOperations();
    result = imm32;
    if d == 15 then // Can only occur for encoding A1
        ALUWritePC(result); // setflags is always FALSE here
    else
        R[d] = result;
        if setflags then
            APSR.N = result<31>;
            APSR.Z = IsZeroBit(result);
            APSR.C = carry;
            // APSR.V unchanged
```

Exceptions

None.

A8.6.97 MOV (register)

Move (register) copies a value from a register to the destination register. It can optionally update the condition flags based on the value.

Encoding T1 ARMv6*, ARMv7 if <Rd> and <Rm> both from R0-R7
ARMv4T, ARMv5T*, ARMv6*, ARMv7 otherwise

MOV<c> <Rd>, <Rm> If <Rd> is the PC, must be outside or last in IT block.

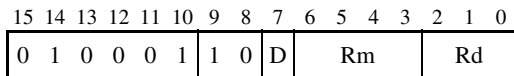

d = UInt(D:Rd); m = UInt(Rm); setflags = FALSE;
if d == 15 && InITBlock() && !LastInITBlock() then UNPREDICTABLE;

Encoding T2 ARMv4T, ARMv5T*, ARMv6*, ARMv7

MOVS <Rd>, <Rm> Not permitted in IT block

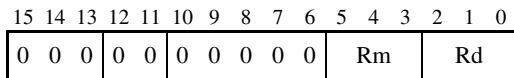

d = UInt(Rd); m = UInt(Rm); setflags = TRUE;
if InITBlock() then UNPREDICTABLE;

Encoding T3 ARMv6T2, ARMv7

MOV{S}<c>.W <Rd>, <Rm>

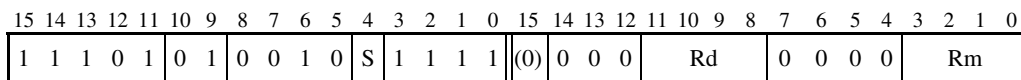

d = UInt(Rd); m = UInt(Rm); setflags = (S == '1');
~~if (d == 13 || BadReg(m)) && setflags then UNPREDICTABLE;~~
~~if (d == 13 && BadReg(m)) || d == 15 then UNPREDICTABLE;~~

Encoding A1 ARMv4*, ARMv5T*, ARMv6*, ARMv7

MOV{S}<c> <Rd>, <Rm>

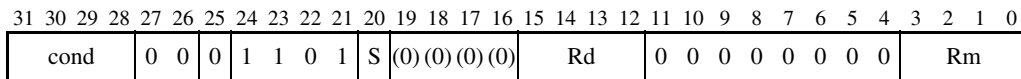

if Rd == '1111' && S == '1' then SEE SUBS PC, LR and related instructions;
d = UInt(Rd); m = UInt(Rm); setflags = (S == '1');

Assembler syntax

MOV{S}<c><q> <Rd>, <Rm>

where:

S If S is present, the instruction updates the flags. Otherwise, the flags are not updated.

- <c><q> See *Standard assembler syntax fields* on page A8-7.
- <Rd> The destination register. This register can be the SP or PC. If this register is the PC and S is specified, see *SUBS PC, LR and related instructions* on page B6-25.
- If <Rd> is the PC:
- the instruction causes a branch to the address moved to the PC
 - in the Thumb and ThumbEE instruction sets:
 - the instruction must either be outside an IT block or the last instruction of an IT block
 - encoding T3 is not permitted.
- In the Thumb and ThumbEE instruction sets, S must not be specified if <Rd> is the SP. If <Rd> is the SP and <Rm> is the SP or PC, encoding T3 is not permitted.
- <Rm> The source register. This register can be the SP or PC. In the Thumb and ThumbEE instruction sets, S must not be specified if <Rm> is the SP or PC.

Note

The use of the following MOV (register) instructions is deprecated:

- ones in which <Rd> is the SP or PC and <Rm> is also the SP or PC
- ones in which S is specified and <Rd> is the SP, <Rm> is the SP, or <Rm> is the PC.

See also *Changing between Thumb state and ARM state* on page A4-2 about the use of the MOV PC,LR instruction.

The pre-UAL syntax MOV<c>S is equivalent to MOV<c>.

Operation

```

if ConditionPassed() then
    EncodingSpecificOperations();
    result = R[m];
    if d == 15 then
        ALUWritePC(result); // setflags is always FALSE here
    else
        R[d] = result;
        if setflags then
            APSR.N = result<31>;
            APSR.Z = IsZeroBit(result);
            APSR.C = carry;
            // APSR.V unchanged
  
```

Exceptions

None.

A8.6.98 MOV (shifted register)

[Move \(shifted register\)](#) is a pseudo-instruction for ASR, LSL, LSR, ROR, and RRX.

For details see the following sections:

- *ASR (immediate)* on page A8-40
- *ASR (register)* on page A8-42
- *LSL (immediate)* on page A8-178
- *LSL (register)* on page A8-180
- *LSR (immediate)* on page A8-182
- *LSR (register)* on page A8-184
- *ROR (immediate)* on page A8-278
- *ROR (register)* on page A8-280
- *RRX* on page A8-282.

Assembler syntax

Table A8-4 shows the equivalences between MOV (shifted register) and other instructions.

Table A8-4 MOV (shifted register) equivalences

MOV instruction	Canonical form
MOV{S} <Rd>, <Rm>, ASR #<n>	ASR{S} <Rd>, <Rm>, #<n>
MOV{S} <Rd>, <Rm>, LSL #<n>	LSL{S} <Rd>, <Rm>, #<n>
MOV{S} <Rd>, <Rm>, LSR #<n>	LSR{S} <Rd>, <Rm>, #<n>
MOV{S} <Rd>, <Rm>, ROR #<n>	ROR{S} <Rd>, <Rm>, #<n>
MOV{S} <Rd>, <Rm>, ASR <Rs>	ASR{S} <Rd>, <Rm>, <Rs>
MOV{S} <Rd>, <Rm>, LSL <Rs>	LSL{S} <Rd>, <Rm>, <Rs>
MOV{S} <Rd>, <Rm>, LSR <Rs>	LSR{S} <Rd>, <Rm>, <Rs>
MOV{S} <Rd>, <Rm>, ROR <Rs>	ROR{S} <Rd>, <Rm>, <Rs>
MOV{S} <Rd>, <Rm>, RRX	RRX{S} <Rd>, <Rm>

Disassembly produces the canonical form of the instruction.

Exceptions

None.

A8.6.99 MOV_T

Move Top writes an immediate value to the top halfword of the destination register. It does not affect the contents of the bottom halfword.

Encoding T1 ARMv6T2, ARMv7

MOV_T<c> <Rd>, #<imm16>

15	14	13	12	11	10	9	8	7	6	5	4	3	2	1	0	15	14	13	12	11	10	9	8	7	6	5	4	3	2	1	0
1	1	1	1	0	i	1	0	1	1	0	0	imm4				0	imm3			Rd				imm8							

d = UInt(Rd); imm16 = imm4:i:imm3:imm8;
 if BadReg(d) then UNPREDICTABLE;

Encoding A1 ARMv6T2, ARMv7

MOV_T<c> <Rd>, #<imm16>

31	30	29	28	27	26	25	24	23	22	21	20	19	18	17	16	15	14	13	12	11	10	9	8	7	6	5	4	3	2	1	0
cond				0	0	1	1	0	1	0	0	imm4				Rd				imm12											

d = UInt(Rd); imm16 = imm4:imm12;
 if d == 15 then UNPREDICTABLE;

Assembler syntax

```
MOVT<c><q> <Rd>, #<imm16>
```

where:

<c><q> See *Standard assembler syntax fields* on page A8-7.

<Rd> The destination register.

<imm16> The immediate value to be written to <Rd>. It must be in the range 0-65535.

Operation

```
if ConditionPassed() then
    EncodingSpecificOperations();
    R[d]<31:16> = imm16;
    // R[d]<15:0> unchanged
```

Exceptions

None.

A8.6.100 MRC, MRC2

Move to ARM core register from Coprocessor causes a coprocessor to transfer a value to an ARM core register or to the condition flags. If no coprocessor can execute the instruction, an Undefined Instruction exception is generated.

This is a generic coprocessor instruction. Some of the fields have no functionality defined by the architecture and are free for use by the coprocessor instruction set designer. These fields are the `opc1`, `opc2`, `CRn`, and `CRm` fields.

For more information about the coprocessors see *Coprocessor support* on page A2-68.

Encoding T1 / A1 ARMv6T2, ARMv7 for encoding T1
 ARMv4*, ARMv5T*, ARMv6*, ARMv7 for encoding A1

MRC<c> <coproc>, <opc1>, <Rt>, <CRn>, <CRm>{, <opc2>}

15	14	13	12	11	10	9	8	7	6	5	4	3	2	1	0	15	14	13	12	11	10	9	8	7	6	5	4	3	2	1	0
1	1	1	0	1	1	1	0	opc1	1	CRn		Rt	coproc	opc2	1	CRm															
31	30	29	28	27	26	25	24	23	22	21	20	19	18	17	16	15	14	13	12	11	10	9	8	7	6	5	4	3	2	1	0
cond		1	1	1	0	opc1	1	CRn		Rt	coproc	opc2	1	CRm																	

```
if coproc == '101x' then SEE "Advanced SIMD and VFP";
t = UInt(Rt); cp = UInt(coproc);
if t == 13 && (CurrentInstrSet() != InstrSet_ARM) then UNPREDICTABLE;
```

Encoding T2 / A2 ARMv6T2, ARMv7 for encoding T2
 ARMv5T*, ARMv6*, ARMv7 for encoding A2

MRC2<c> <coproc>, <opc1>, <Rt>, <CRn>, <CRm>{, <opc2>}

15	14	13	12	11	10	9	8	7	6	5	4	3	2	1	0	15	14	13	12	11	10	9	8	7	6	5	4	3	2	1	0
1	1	1	1	1	1	1	0	opc1	1	CRn		Rt	coproc	opc2	1	CRm															
31	30	29	28	27	26	25	24	23	22	21	20	19	18	17	16	15	14	13	12	11	10	9	8	7	6	5	4	3	2	1	0
1	1	1	1	1	1	1	0	opc1	1	CRn		Rt	coproc	opc2	1	CRm															

```
t = UInt(Rt); cp = UInt(coproc);
if t == 13 && (CurrentInstrSet() != InstrSet_ARM) then UNPREDICTABLE;
```

Advanced SIMD and VFP See 8, 16, and 32-bit transfer between ARM core and extension registers on page A7-31

Assembler syntax

```
MRC{2}<c><q> <coproc>, #<opc1>, <Rt>, <CRn>, <CRm>{, #<opc2>}
```

where:

2	If specified, selects encoding T2 / A2. If omitted, selects encoding T1 / A1.
<c><q>	See <i>Standard assembler syntax fields</i> on page A8-7. An ARM MRC2 instruction must be unconditional.
<coproc>	The name of the coprocessor. The standard generic coprocessor names are p0, p1, ..., p15.
<opc1>	Is a coprocessor-specific opcode in the range 0 to 7.
<Rt>	Is the destination ARM core register. This register can be R0-R14 or APSR_nzcv. The last form writes bits [31:28] of the transferred value to the N, Z, C and V condition flags and is specified by setting the Rt field of the encoding to 0b1111. In pre-UAL assembler syntax, PC was written instead of APSR_nzcv to select this form.
<CRn>	Is the coprocessor register that contains the first operand.
<CRm>	Is an additional source or destination coprocessor register.
<opc2>	Is a coprocessor-specific opcode in the range 0 to 7. If omitted, <opc2> is assumed to be 0.

Operation

```
if ConditionPassed() then
    EncodingSpecificOperations();
    if !Coprocc_Accepted(cp, ThisInstr()) then
        GenerateCoproccorException();
    else
        value = Coproc_GetOneWord(cp, ThisInstr());
        if t != 15 then
            R[t] = value;
        else
            APSR.N = value<31>;
            APSR.Z = value<30>;
            APSR.C = value<29>;
            APSR.V = value<28>;
            // value<27:0> are not used.
```

Exceptions

Undefined Instruction.

A8.6.101 MRRC, MRRC2

Move to two ARM core registers from Coprocessor causes a coprocessor to transfer values to two ARM core registers. If no coprocessor can execute the instruction, an Undefined Instruction exception is generated.

This is a generic coprocessor instruction. The `opc1` and `CRm` fields have no functionality defined by the architecture and are free for use by the coprocessor instruction set designer.

For more information about the coprocessors see *Coprocessor support* on page A2-68.

Encoding T1 / A1 ARMv6T2, ARMv7 for encoding T1
 ARMv5TE*, ARMv6*, ARMv7 for encoding A1

MRRC<c> <coproc>, <opc>, <Rt>, <Rt2>, <CRm>

15	14	13	12	11	10	9	8	7	6	5	4	3	2	1	0	15	14	13	12	11	10	9	8	7	6	5	4	3	2	1	0
1	1	1	0	1	1	0	0	0	1	0	1	Rt2				Rt		coproc		opc1		CRm									
31	30	29	28	27	26	25	24	23	22	21	20	19	18	17	16	15	14	13	12	11	10	9	8	7	6	5	4	3	2	1	0
cond		1	1	0	0	0	1	0	1	Rt2				Rt		coproc		opc1		CRm											

```
if coproc == '101x' then SEE "Advanced SIMD and VFP";
t = UInt(Rt); t2 = UInt(Rt2); cp = UInt(coproc);
if t == 15 || t2 == 15 || t == t2 then UNPREDICTABLE;
if (t == 13 || t2 == 13) && (CurrentInstrSet() != InstrSet_ARM) then UNPREDICTABLE;
```

Encoding T2 / A2 ARMv6T2, ARMv7 for encoding T2
 ARMv6*, ARMv7 for encoding A2

MRRC2<c> <coproc>, <opc>, <Rt>, <Rt2>, <CRm>

15	14	13	12	11	10	9	8	7	6	5	4	3	2	1	0	15	14	13	12	11	10	9	8	7	6	5	4	3	2	1	0
1	1	1	1	1	1	0	0	0	1	0	1	Rt2				Rt		coproc		opc1		CRm									
31	30	29	28	27	26	25	24	23	22	21	20	19	18	17	16	15	14	13	12	11	10	9	8	7	6	5	4	3	2	1	0
1	1	1	1	1	1	0	0	0	1	0	1	Rt2				Rt		coproc		opc1		CRm									

```
t = UInt(Rt); t2 = UInt(Rt2); cp = UInt(coproc);
if t == 15 || t2 == 15 || t == t2 then UNPREDICTABLE;
if (t == 13 || t2 == 13) && (CurrentInstrSet() != InstrSet_ARM) then UNPREDICTABLE;
```

Advanced SIMD and VFP See *64-bit transfers between ARM core and extension registers* on page A7-32

Assembler syntax

MRRC{2}<c><q> <coproc>, #<opc1>, <Rt>, <Rt2>, <CRm>

where:

- 2 If specified, selects encoding T2 / A2. If omitted, selects encoding T1 / A1.
- <c><q> See *Standard assembler syntax fields* on page A8-7. An ARM MRRC2 instruction must be unconditional.
- <coproc> The name of the coprocessor. The standard generic coprocessor names are p0, p1, ..., p15.
- <opc1> Is a coprocessor-specific opcode in the range 0 to 15.
- <Rt> Is the first destination ARM core register.
- <Rt2> Is the second destination ARM core register.
- <CRm> Is the coprocessor register that supplies the data to be transferred.

Operation

```

if ConditionPassed() then
    EncodingSpecificOperations();
    if !Coproc_Accepted(cp, ThisInstr()) then
        GenerateCoprocessorException();
    else
        (R[t], R[t2]) = Coproc_GetTwoWords(cp, ThisInstr());

```

Exceptions

Undefined Instruction.

A8.6.102 MRS

Move to Register from Special Register moves the value from the APSR into a general-purpose register.

For details of system level use of this instruction, see *MRS* on page B6-10.

Encoding T1 ARMv6T2, ARMv7

MRS<c> <Rd>, <spec_reg>

15	14	13	12	11	10	9	8	7	6	5	4	3	2	1	0	15	14	13	12	11	10	9	8	7	6	5	4	3	2	1	0
1	1	1	1	0	0	1	1	1	1	1	0	(1)	(1)	(1)	(1)	(1)	1	0	(0)	0		Rd		(0)	(0)	(0)	(0)	(0)	(0)	(0)	(0)

d = UInt(Rd);
 if BadReg(d) then UNPREDICTABLE;

Encoding A1 ARMv4*, ARMv5T*, ARMv6*, ARMv7

MRS<c> <Rd>, <spec_reg>

31	30	29	28	27	26	25	24	23	22	21	20	19	18	17	16	15	14	13	12	11	10	9	8	7	6	5	4	3	2	1	0
cond	0	0	0	1	0	0	0	0	(1)	(1)	(1)	(1)	(1)		Rd		(0)	(0)	(0)	(0)		0	0	0	0		(0)	(0)	(0)	(0)	

d = UInt(Rd);
 if d == 15 then UNPREDICTABLE;

Assembler syntax

MRS<c><q> <Rd>, <spec_reg>

where:

<c><q> See *Standard assembler syntax fields* on page A8-7.

<Rd> The destination register.

<spec_reg> Is one of:

- APSR
- CPSR.

ARM recommends the APSR form in application level code. For more information, see *The Application Program Status Register (APSR)* on page A2-14.

Operation

```
if ConditionPassed() then
    EncodingSpecificOperations();
    R[d] = APSR;
```

Exceptions

None.

A8.6.103 MSR (immediate)

Move immediate value to Special Register moves selected bits of an immediate value to the corresponding bits in the APSR.

For details of system level use of this instruction, see *MSR (immediate)* on page B6-12.

Encoding A1 ARMv4*, ARMv5T*, ARMv6*, ARMv7

MSR<c> <spec_reg>, #<const>

31	30	29	28	27	26	25	24	23	22	21	20	19	18	17	16	15	14	13	12	11	10	9	8	7	6	5	4	3	2	1	0
cond		0	0	1	1	0	0	1	0	mask	0	0	(1)	(1)	(1)	(1)	imm12														

```
if mask == '00' then SEE "Related encodings";
imm32 = ARMEExpandImm(imm12); write_nzcvq = (mask<1> == '1'); write_g = (mask<0> == '1');
if n == 15 then UNPREDICTABLE;
```

Assembler syntax

MSR<c><q> <spec_reg>, #<imm>

where:

<c><q> See *Standard assembler syntax fields* on page A8-7.

<spec_reg> Is one of:

- APSR_<bits>
- CPSR_<fields>.

ARM recommends the APSR forms in application level code. For more information, see *The Application Program Status Register (APSR)* on page A2-14.

<imm> Is the immediate value to be transferred to <spec_reg>. See *Modified immediate constants in ARM instructions* on page A5-9 for the range of values.

<bits> Is one of nzcvq, g, or nzcvqg.

In the A and R profiles:

- APSR_nzcvq is the same as CPSR_f
- APSR_g is the same as CPSR_s
- APSR_nzcvqg is the same as CPSR_fs.

<fields> Is a sequence of one or more of the following: s, f.

Operation

```

if ConditionPassed() then
    EncodingSpecificOperations();
    if write_nzcvq then
        APSR.N = imm32<31>;
        APSR.Z = imm32<30>;
        APSR.C = imm32<29>;
        APSR.V = imm32<28>;
        APSR.Q = imm32<27>;
    if write_g then
        APSR.GE = imm32<19:16>;

```

Exceptions

None.

Usage

For details of the APSR see *The Application Program Status Register (APSR)* on page A2-14. Because of the Do-Not-Modify nature of its reserved bits, the immediate form of MSR is normally only useful at the Application level for writing to APSR_nzcvq (CPSR_f).

For the A and R profiles, *MSR (immediate)* on page B6-12 describes additional functionality that is available using the reserved bits. This includes some deprecated functionality that is available in unprivileged and privileged modes and therefore can be used at the Application level.

A8.6.104 MSR (register)

Move to Special Register from ARM core register moves selected bits of a general-purpose register to the APSR.

For details of system level use of this instruction, see *MSR (register)* on page B6-14.

Encoding T1 ARMv6T2, ARMv7

MSR<c> <spec_reg>, <Rn>

15	14	13	12	11	10	9	8	7	6	5	4	3	2	1	0	15	14	13	12	11	10	9	8	7	6	5	4	3	2	1	0
1	1	1	1	0	0	1	1	1	0	0	0	Rn				1	0	(0)	0	mask	0	0	(0)	(0)	(0)	(0)	(0)	(0)	(0)	(0)	

n = UInt(Rn); write_nzcvq = (mask<1> == '1'); write_g = (mask<0> == '1');
 if mask == '00' then UNPREDICTABLE;
 if n == 15 then UNPREDICTABLE;

Encoding A1 ARMv4*, ARMv5T*, ARMv6*, ARMv7

MSR<c> <spec_reg>, <Rn>

31	30	29	28	27	26	25	24	23	22	21	20	19	18	17	16	15	14	13	12	11	10	9	8	7	6	5	4	3	2	1	0
cond		0	0	0	1	0	0	1	0	mask	0	0	(1)	(1)	(1)	(1)	(0)	(0)	(0)	(0)	0	0	0	0	Rn						

n = UInt(Rn); write_nzcvq = (mask<1> == '1'); write_g = (mask<0> == '1');
 if mask == '00' then UNPREDICTABLE;
 if n == 15 then UNPREDICTABLE;

Assembler syntax

MSR<c><q> <spec_reg>, <Rn>

where:

<c><q> See *Standard assembler syntax fields* on page A8-7.

<spec_reg> Is one of:

- APSR_<bits>
- CPSR_<fields>.

ARM recommends the APSR forms in application level code. For more information, see *The Application Program Status Register (APSR)* on page A2-14.

<Rn> Is the general-purpose register to be transferred to <spec_reg>.

<bits> Is one of nzcvq, g, or nzcvqg.

In the A and R profiles:

- APSR_nzcvq is the same as CPSR_f
- APSR_g is the same as CPSR_s
- APSR_nzcvqg is the same as CPSR_fs.

<fields> Is a sequence of one or more of the following: s, f.

Operation

```

if ConditionPassed() then
    EncodingSpecificOperations();
    if write_nzcvq then
        APSR.N = R[n]<31>;
        APSR.Z = R[n]<30>;
        APSR.C = R[n]<29>;
        APSR.V = R[n]<28>;
        APSR.Q = R[n]<27>;
    if write_g then
        APSR.GE = R[n]<19:16>;

```

Exceptions

None.

Usage

For details of the APSR see *The Application Program Status Register (APSR)* on page A2-14. Because of the Do-Not-Modify nature of its reserved bits, a read / modify / write sequence is normally needed when the MSR instruction is being used at Application level and its destination is not APSR_nzcvq (CPSR_f).

For the A and R profiles, *MSR (register)* on page B6-14 describes additional functionality that is available using the reserved bits. This includes some deprecated functionality that is available in unprivileged and privileged modes and therefore can be used at the Application level.

A8.6.105 MUL

Multiply multiplies two register values. The least significant 32 bits of the result are written to the destination register. These 32 bits do not depend on whether the source register values are considered to be signed values or unsigned values.

Optionally, it can update the condition flags based on the result. In the Thumb instruction set, this option is limited to only a few forms of the instruction. Use of this option adversely affects performance on many processor implementations.

Encoding T1 ARMv4T, ARMv5T*, ARMv6*, ARMv7

MULS <Rdm>, <Rn>, <Rdm>

Outside IT block.

MUL<C> <Rdm>, <Rn>, <Rdm>

Inside IT block.

15	14	13	12	11	10	9	8	7	6	5	4	3	2	1	0
0	1	0	0	0	0	1	1	0	1	Rn			Rdm		

```
d = UInt(Rdm); n = UInt(Rn); m = UInt(Rdm); setflags = !InITBlock();
if ArchVersion() < 6 && d == n then UNPREDICTABLE;
```

Encoding T2 ARMv6T2, ARMv7

MUL<C> <Rd>, <Rn>, <Rm>

15	14	13	12	11	10	9	8	7	6	5	4	3	2	1	0	15	14	13	12	11	10	9	8	7	6	5	4	3	2	1	0
1	1	1	1	1	0	1	1	0	0	0	0	Rn			1	1	1	1	Rd			0	0	0	0	Rm					

```
d = UInt(Rd); n = UInt(Rn); m = UInt(Rm); setflags = FALSE;
if BadReg(d) || BadReg(n) || BadReg(m) then UNPREDICTABLE;
```

Encoding A1 ARMv4*, ARMv5T*, ARMv6*, ARMv7

MUL{S}<C> <Rd>, <Rn>, <Rm>

31	30	29	28	27	26	25	24	23	22	21	20	19	18	17	16	15	14	13	12	11	10	9	8	7	6	5	4	3	2	1	0
cond		0	0	0	0	0	0	0	0	S	Rd			(0)(0)(0)(0)			Rm			1	0	0	1	Rn							

```
d = UInt(Rd); n = UInt(Rn); m = UInt(Rm); setflags = (S == '1');
if d == 15 || n == 15 || m == 15 then UNPREDICTABLE;
if ArchVersion() < 6 && d == n then UNPREDICTABLE;
```

Assembler syntax

```
MUL{S}<C><q> {<Rd>}, <Rn>, <Rm>
```

where:

S	If S is present, the instruction updates the flags. Otherwise, the flags are not updated. In the Thumb instruction set, S can be specified only if both <Rn> and <Rm> are R0-R7 and the instruction is outside an IT block.
<C><q>	See <i>Standard assembler syntax fields</i> on page A8-7.
<Rd>	The destination register.
<Rn>	The first operand register.
<Rm>	The second operand register.

Operation

```
if ConditionPassed() then
    EncodingSpecificOperations();
    operand1 = SInt(R[n]); // operand1 = UInt(R[n]) produces the same final results
    operand2 = SInt(R[m]); // operand2 = UInt(R[m]) produces the same final results
    result = operand1 * operand2;
    R[d] = result<31:0>;
    if setflags then
        APSR.N = result<31>;
        APSR.Z = IsZeroBit(result);
        if ArchVersion() == 4 then
            APSR.C = bit UNKNOWN;
        // else APSR.C unchanged
        // APSR.V always unchanged
```

Exceptions

None.

A8.6.106 MVN (immediate)

Bitwise NOT (immediate) writes the bitwise inverse of an immediate value to the destination register. It can optionally update the condition flags based on the value.

Encoding T1 ARMv6T2, ARMv7

MVN{S}<C> <Rd>, #<const>

15	14	13	12	11	10	9	8	7	6	5	4	3	2	1	0	15	14	13	12	11	10	9	8	7	6	5	4	3	2	1	0	
1	1	1	1	0	i	0	0	0	1	1	S	1	1	1	1	0	imm3				Rd				imm8							

```
d = UInt(Rd); setflags = (S == '1');
(imm32, carry) = ThumbExpandImm_C(i:imm3:imm8, APSR.C);
if BadReg(d) then UNPREDICTABLE;
```

Encoding A1 ARMv4*, ARMv5T*, ARMv6*, ARMv7

MVN{S}<C> <Rd>, #<const>

31	30	29	28	27	26	25	24	23	22	21	20	19	18	17	16	15	14	13	12	11	10	9	8	7	6	5	4	3	2	1	0
cond				0	0	1	1	1	1	1	S	(0)	(0)	(0)	(0)	Rd				imm12											

```
if Rd == '1111' && S == '1' then SEE SUBS PC, LR and related instructions;
d = UInt(Rd); setflags = (S == '1');
(imm32, carry) = ARMEExpandImm_C(imm12, APSR.C);
```

Assembler syntax

MVN{S}<c><q> <Rd>, #<const>

where:

- S If S is present, the instruction updates the flags. Otherwise, the flags are not updated.
- <c><q> See *Standard assembler syntax fields* on page A8-7.
- <Rd> The destination register [1](#).
- <const> The immediate value to be bitwise inverted. See *Modified immediate constants in Thumb instructions* on page A6-17 or *Modified immediate constants in ARM instructions* on page A5-9 for the range of values.

The pre-UAL syntax MVN<c>S is equivalent to MVNS<c>.

Operation

```

if ConditionPassed() then
    EncodingSpecificOperations();
    result = NOT(imm32);
    if d == 15 then          // Can only occur for ARM encoding
        ALUWritePC(result); // setflags is always FALSE here
    else
        R[d] = result;
        if setflags then
            APSR.N = result<31>;
            APSR.Z = IsZeroBit(result);
            APSR.C = carry;
            // APSR.V unchanged

```

Exceptions

None.

A8.6.107 MVN (register)

Bitwise NOT (register) writes the bitwise inverse of a register value to the destination register. It can optionally update the condition flags based on the result.

Encoding T1 ARMv4T, ARMv5T*, ARMv6*, ARMv7

MVNS <Rd>, <Rm>

Outside IT block.

MVN<C> <Rd>, <Rm>

Inside IT block.

15	14	13	12	11	10	9	8	7	6	5	4	3	2	1	0
0	1	0	0	0	0	1	1	1	1	Rm	Rd				

d = UInt(Rd); m = UInt(Rm); setflags = !InITBlock();
 (shift_t, shift_n) = (SRTYPE_LSL, 0);

Encoding T2 ARMv6T2, ARMv7

MVN{S}<C>.W <Rd>, <Rm>{, <shift>}

15	14	13	12	11	10	9	8	7	6	5	4	3	2	1	0	15	14	13	12	11	10	9	8	7	6	5	4	3	2	1	0
1	1	1	0	1	0	1	0	0	1	1	S	1	1	1	1	(0)	imm3	Rd	imm2	type	Rm										

d = UInt(Rd); m = UInt(Rm); setflags = (S == '1');
 (shift_t, shift_n) = DecodeImmShift(type, imm3:imm2);
 if BadReg(d) || BadReg(m) then UNPREDICTABLE;

Encoding A1 ARMv4*, ARMv5T*, ARMv6*, ARMv7

MVN{S}<C> <Rd>, <Rm>{, <shift>}

31	30	29	28	27	26	25	24	23	22	21	20	19	18	17	16	15	14	13	12	11	10	9	8	7	6	5	4	3	2	1	0
cond		0	0	0	1	1	1	1	S	(0)	(0)	(0)	(0)	Rd	imm5			type	0	Rm											

if Rd == '1111' && S == '1' then SEE SUBS PC, LR and related instructions;
 d = UInt(Rd); m = UInt(Rm); setflags = (S == '1');
 (shift_t, shift_n) = DecodeImmShift(type, imm5);

Assembler syntax

```
MVN{S}<c><q> <Rd>, <Rm> {, <shift>}
```

where:

- S If S is present, the instruction updates the flags. Otherwise, the flags are not updated.
- <c><q> See *Standard assembler syntax fields* on page A8-7.
- <Rd> The destination register.
- <Rm> The register that is optionally shifted and used as the source register.
- <shift> The shift to apply to the value read from <Rm>. If present, encoding T1 is not permitted. If absent, no shift is applied and all encodings are permitted. *Shifts applied to a register* on page A8-10 describes the shifts and how they are encoded.

The pre-UAL syntax MVN<c>S is equivalent to MVNS<c>.

Operation

```
if ConditionPassed() then
    EncodingSpecificOperations();
    (shifted, carry) = Shift_C(R[m], shift_t, shift_n, APSR.C);
    result = NOT(shifted);
    if d == 15 then        // Can only occur for ARM encoding
        ALUWritePC(result); // setflags is always FALSE here
    else
        R[d] = result;
        if setflags then
            APSR.N = result<31>;
            APSR.Z = IsZeroBit(result);
            APSR.C = carry;
            // APSR.V unchanged
```

Exceptions

None.

A8.6.108 MVN (register-shifted register)

Bitwise NOT (register-shifted register) writes the bitwise inverse of a register-shifted register value to the destination register. It can optionally update the condition flags based on the result.

Encoding A1 ARMv4*, ARMv5T*, ARMv6*, ARMv7

MVN{S}<c> <Rd>, <Rm>, <type> <Rs>

31	30	29	28	27	26	25	24	23	22	21	20	19	18	17	16	15	14	13	12	11	10	9	8	7	6	5	4	3	2	1	0
cond			0	0	0	1	1	1	1	S	(0)	(0)	(0)	(0)	Rd				Rs				0	type		1	Rm				

```
d = UInt(Rd);  m = UInt(Rm);  s = UInt(Rs);
setflags = (S == '1');  shift_t = DecodeRegShift(type);
if d == 15 || m == 15 || s == 15 then UNPREDICTABLE;
```

Assembler syntax

MVN{S}<c><q> <Rd>, <Rm>, <type> <Rs>

where:

S	If S is present, the instruction updates the flags. Otherwise, the flags are not updated.								
<c><q>	See <i>Standard assembler syntax fields</i> on page A8-7.								
<Rd>	The destination register.								
<Rm>	The register that is shifted and used as the operand.								
<type>	The type of shift to apply to the value read from <Rm>. It must be one of: <table> <tr> <td>ASR</td> <td>Arithmetic shift right, encoded as type = 0b10</td> </tr> <tr> <td>LSL</td> <td>Logical shift left, encoded as type = 0b00</td> </tr> <tr> <td>LSR</td> <td>Logical shift right, encoded as type = 0b01</td> </tr> <tr> <td>ROR</td> <td>Rotate right, encoded as type = 0b11.</td> </tr> </table>	ASR	Arithmetic shift right, encoded as type = 0b10	LSL	Logical shift left, encoded as type = 0b00	LSR	Logical shift right, encoded as type = 0b01	ROR	Rotate right, encoded as type = 0b11.
ASR	Arithmetic shift right, encoded as type = 0b10								
LSL	Logical shift left, encoded as type = 0b00								
LSR	Logical shift right, encoded as type = 0b01								
ROR	Rotate right, encoded as type = 0b11.								
<Rs>	The register whose bottom byte contains the amount to shift by.								

The pre-UAL syntax MVN<c>S is equivalent to MVNS<c>.

Operation

```

if ConditionPassed() then
    EncodingSpecificOperations();
    shift_n = UInt(R[s]<7:0>);
    (shifted, carry) = Shift_C(R[m], shift_t, shift_n, APSR.C);
    result = NOT(shifted);
    R[d] = result;
    if setflags then
        APSR.N = result<31>;
        APSR.Z = IsZeroBit(result);
        APSR.C = carry;
        // APSR.V unchanged
  
```

Exceptions

None.

A8.6.109 NEG

Negate is a pre-UAL synonym for RSB (immediate) with an immediate value of 0. For details see *RSB (immediate)* on page A8-284.

Assembler syntax

NEG<c><q> <Rd>, <Rm>

This is equivalent to:

RSBS<c><q> <Rd>, <Rm>, #0

Exceptions

None.

A8.6.110 NOP

No Operation does nothing. This instruction can be used for code alignment purposes.

See *Pre-UAL pseudo-instruction NOP* on page AppxC-3 for details of NOP before the introduction of UAL and the ARMv6K and ARMv6T2 architecture variants.

———— **Note** —————

The timing effects of including a NOP instruction in code are not guaranteed. It can increase execution time, leave it unchanged, or even reduce it. NOP instructions are therefore not suitable for timing loops.

Encoding T1 ARMv6T2, ARMv7

NOP<C>

15	14	13	12	11	10	9	8	7	6	5	4	3	2	1	0
1	0	1	1	1	1	1	1	0	0	0	0	0	0	0	0

// No additional decoding required

Encoding T2 ARMv6T2, ARMv7

NOP<C>.W

15	14	13	12	11	10	9	8	7	6	5	4	3	2	1	0	15	14	13	12	11	10	9	8	7	6	5	4	3	2	1	0
1	1	1	1	0	0	1	1	1	0	1	0	(1)	(1)	(1)	(1)	1	0	(0)	0	(0)	0	0	0	0	0	0	0	0	0	0	

// No additional decoding required

Encoding A1 ARMv6K, ARMv6T2, ARMv7

NOP<C>

31	30	29	28	27	26	25	24	23	22	21	20	19	18	17	16	15	14	13	12	11	10	9	8	7	6	5	4	3	2	1	0
cond		0	0	1	1	0	0	1	0	0	0	0	0	(1)	(1)	(1)	(1)	(0)	(0)	(0)	(0)	0	0	0	0	0	0	0	0	0	0

// No additional decoding required

Assembler syntax

NOP<c><q>

where:

<c><q> See *Standard assembler syntax fields* on page A8-7.

Operation

```
if ConditionPassed() then
    EncodingSpecificOperations();
// Do nothing
```

Exceptions

None.

A8.6.111 ORN (immediate)

Bitwise OR NOT (immediate) performs a bitwise (inclusive) OR of a register value and the complement of an immediate value, and writes the result to the destination register. It can optionally update the condition flags based on the result.

Encoding T1 ARMv6T2, ARMv7

ORN{S}<c> <Rd>, <Rn>, #<const>

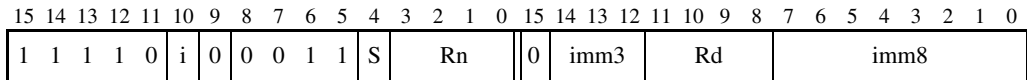

```

if Rn == '1111' then SEE MVN (immediate);
d = UInt(Rd); n = UInt(Rn); setflags = (S == '1');
(imm32, carry) = ThumbExpandImm_C(i:imm3:imm8, APSR.C);
if BadReg(d) || n == 13 then UNPREDICTABLE;
    
```

Assembler syntax

ORN{S}<C><Q> {<Rd>}, <Rn>, #<const>

where:

- S If S is present, the instruction updates the flags. Otherwise, the flags are not updated.
- <C><Q> See *Standard assembler syntax fields* on page A8-7.
- <Rd> The destination register.
- <Rn> The register that contains the operand.
- <const> The immediate value to be bitwise inverted and ORed with the value obtained from <Rn>. See *Modified immediate constants in Thumb instructions* on page A6-17 for the range of values.

Operation

```
if ConditionPassed() then
    EncodingSpecificOperations();
    result = R[n] OR NOT(imm32);
    R[d] = result;
    if setflags then
        APSR.N = result<31>;
        APSR.Z = IsZeroBit(result);
        APSR.C = carry;
        // APSR.V unchanged
```

Exceptions

None.

A8.6.112 ORN (register)

Bitwise OR NOT (register) performs a bitwise (inclusive) OR of a register value and the complement of an optionally-shifted register value, and writes the result to the destination register. It can optionally update the condition flags based on the result.

Encoding T1 ARMv6T2, ARMv7

ORN{S}<c> <Rd>, <Rn>, <Rm>{, <shift>}

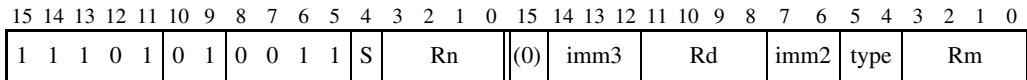

```

if Rn == '1111' then SEE MVN (register);
d = UInt(Rd); n = UInt(Rn); m = UInt(Rm); setflags = (S == '1');
(shift_t, shift_n) = DecodeImmShift(type, imm3:imm2);
if BadReg(d) || n == 13 || BadReg(m) then UNPREDICTABLE;
    
```

Assembler syntax

ORN{S}<C><Q> {<Rd>}, <Rn>, <Rm> {,<shift>}

where:

S	If S is present, the instruction updates the flags. Otherwise, the flags are not updated.
<C><Q>	See <i>Standard assembler syntax fields</i> on page A8-7.
<Rd>	The destination register.
<Rn>	The first operand register.
<Rm>	The register that is optionally shifted and used as the second operand.
<shift>	The shift to apply to the value read from <Rm>. If omitted, no shift is applied. <i>Shifts applied to a register</i> on page A8-10 describes the shifts and how they are encoded.

Operation

```

if ConditionPassed() then
    EncodingSpecificOperations();
    (shifted, carry) = Shift_C(R[m], shift_t, shift_n, APSR.C);
    result = R[n] OR NOT(shifted);
    R[d] = result;
    if setflags then
        APSR.N = result<31>;
        APSR.Z = IsZeroBit(result);
        APSR.C = carry;
        // APSR.V unchanged

```

Exceptions

None.

A8.6.113 ORR (immediate)

Bitwise OR (immediate) performs a bitwise (inclusive) OR of a register value and an immediate value, and writes the result to the destination register. It can optionally update the condition flags based on the result.

Encoding T1 ARMv6T2, ARMv7

ORR{S}<c> <Rd>, <Rn>, #<const>

15	14	13	12	11	10	9	8	7	6	5	4	3	2	1	0	15	14	13	12	11	10	9	8	7	6	5	4	3	2	1	0
1	1	1	1	0	i	0	0	0	1	0	S	Rn				0	imm3				Rd				imm8						

```

if Rn == '1111' then SEE MOV (immediate);
d = UInt(Rd); n = UInt(Rn); setflags = (S == '1');
(imm32, carry) = ThumbExpandImm_C(i:imm3:imm8, APSR.C);
if BadReg(d) || n == 13 then UNPREDICTABLE;
    
```

Encoding A1 ARMv4*, ARMv5T*, ARMv6*, ARMv7

ORR{S}<c> <Rd>, <Rn>, #<const>

31	30	29	28	27	26	25	24	23	22	21	20	19	18	17	16	15	14	13	12	11	10	9	8	7	6	5	4	3	2	1	0
cond		0	0	1	1	1	0	0	S	Rn				Rd				imm12													

```

if Rd == '1111' && S == '1' then SEE SUBS PC, LR and related instructions;
d = UInt(Rd); n = UInt(Rn); setflags = (S == '1');
(imm32, carry) = ARMEExpandImm_C(imm12, APSR.C);
    
```

Assembler syntax

ORR{S}<C><q> {<Rd>}, <Rn>, #<const>

where:

- S If S is present, the instruction updates the flags. Otherwise, the flags are not updated.
- <C><q> See *Standard assembler syntax fields* on page A8-7.
- <Rd> The destination register [1](#).
- <Rn> The register that contains the operand [1](#).
- <const> The immediate value to be bitwise ORed with the value obtained from <Rn>. See *Modified immediate constants in Thumb instructions* on page A6-17 or *Modified immediate constants in ARM instructions* on page A5-9 for the range of values.

The pre-UAL syntax ORR<C>S is equivalent to ORRS<C>.

Operation

```

if ConditionPassed() then
    EncodingSpecificOperations();
    result = R[n] OR imm32;
    if d == 15 then // Can only occur for ARM encoding
        ALUWritePC(result); // setflags is always FALSE here
    else
        R[d] = result;
        if setflags then
            APSR.N = result<31>;
            APSR.Z = IsZeroBit(result);
            APSR.C = carry;
            // APSR.V unchanged

```

Exceptions

None.

A8.6.114 ORR (register)

Bitwise OR (register) performs a bitwise (inclusive) OR of a register value and an optionally-shifted register value, and writes the result to the destination register. It can optionally update the condition flags based on the result.

Encoding T1 ARMv4T, ARMv5T*, ARMv6*, ARMv7

ORRS <Rdn>, <Rm> Outside IT block.
 ORR<c> <Rdn>, <Rm> Inside IT block.

15	14	13	12	11	10	9	8	7	6	5	4	3	2	1	0
0 1 0 0 0 0						1 1 0 0			Rm			Rdn			

d = UInt(Rdn); n = UInt(Rdn); m = UInt(Rm); setflags = !InITBlock();
 (shift_t, shift_n) = (SRTYPE_LSL, 0);

Encoding T2 ARMv6T2, ARMv7

ORR{S}<c>.W <Rd>, <Rn>, <Rm>{, <shift>}

15	14	13	12	11	10	9	8	7	6	5	4	3	2	1	0	15	14	13	12	11	10	9	8	7	6	5	4	3	2	1	0
1 1 1 0 1						0 1 0 0 1 0			S	Rn			(0)	imm3			Rd			imm2		type		Rm							

if Rn == '1111' then SEE MOV (register);
 d = UInt(Rd); n = UInt(Rn); m = UInt(Rm); setflags = (S == '1');
 (shift_t, shift_n) = DecodeImmShift(type, imm3:imm2);
 if BadReg(d) || n == 13 || BadReg(m) then UNPREDICTABLE;

Encoding A1 ARMv4*, ARMv5T*, ARMv6*, ARMv7

ORR{S}<c> <Rd>, <Rn>, <Rm>{, <shift>}

31	30	29	28	27	26	25	24	23	22	21	20	19	18	17	16	15	14	13	12	11	10	9	8	7	6	5	4	3	2	1	0
cond			0 0 0			1 1 0 0			S	Rn			Rd			imm5			type		0		Rm								

if Rd == '1111' && S == '1' then SEE SUBS PC, LR and related instructions;
 d = UInt(Rd); n = UInt(Rn); m = UInt(Rm); setflags = (S == '1');
 (shift_t, shift_n) = DecodeImmShift(type, imm5);

Assembler syntax

ORR{S}<C><q> {<Rd>}, <Rn>, <Rm> {,<shift>}

where:

S	If S is present, the instruction updates the flags. Otherwise, the flags are not updated.
<C><q>	See <i>Standard assembler syntax fields</i> on page A8-7.
<Rd>	The destination register ↓
<Rn>	The first operand register ↓
<Rm>	The register that is optionally shifted and used as the second operand ↓
<shift>	The shift to apply to the value read from <Rm>. If present, encoding T1 is not permitted. If absent, no shift is applied and all encodings are permitted. <i>Shifts applied to a register</i> on page A8-10 describes the shifts and how they are encoded.

In Thumb assembly:

- outside an IT block, if ORRS <Rd>, <Rn>, <Rd> is written with <Rd> and <Rn> both in the range R0-R7, it is assembled using encoding T1 as though ORRS <Rd>, <Rn> had been written
- inside an IT block, if ORR<C> <Rd>, <Rn>, <Rd> is written with <Rd> and <Rn> both in the range R0-R7, it is assembled using encoding T1 as though ORR<C> <Rd>, <Rn> had been written.

To prevent either of these happening, use the .W qualifier.

The pre-UAL syntax ORR<C>S is equivalent to ORRS<C>.

Operation

```

if ConditionPassed() then
    EncodingSpecificOperations();
    (shifted, carry) = Shift_C(R[m], shift_t, shift_n, APSR.C);
    result = R[n] OR shifted;
    if d == 15 then // Can only occur for ARM encoding
        ALUWritePC(result); // setflags is always FALSE here
    else
        R[d] = result;
        if setflags then
            APSR.N = result<31>;
            APSR.Z = IsZeroBit(result);
            APSR.C = carry;
            // APSR.V unchanged

```

Exceptions

None.

A8.6.115 ORR (register-shifted register)

Bitwise OR (register-shifted register) performs a bitwise (inclusive) OR of a register value and a register-shifted register value, and writes the result to the destination register. It can optionally update the condition flags based on the result.

Encoding A1 ARMv4*, ARMv5T*, ARMv6*, ARMv7

ORR{S}<C> <Rd>, <Rn>, <Rm>, <type> <Rs>

31	30	29	28	27	26	25	24	23	22	21	20	19	18	17	16	15	14	13	12	11	10	9	8	7	6	5	4	3	2	1	0
cond			0	0	0	1	1	0	0	S	Rn				Rd				Rs		0	type		1	Rm						

```
d = UInt(Rd); n = UInt(Rn); m = UInt(Rm); s = UInt(Rs);
setflags = (S == '1'); shift_t = DecodeRegShift(type);
if d == 15 || n == 15 || m == 15 || s == 15 then UNPREDICTABLE;
```

Assembler syntax

```
ORR{S}<C><Q> {<Rd>}, <Rn>, <Rm>, <type> <Rs>
```

where:

S If S is present, the instruction updates the flags. Otherwise, the flags are not updated.

<C><Q> See *Standard assembler syntax fields* on page A8-7.

<Rd> The destination register.

<Rn> The first operand register.

<Rm> The register that is shifted and used as the second operand.

<type> The type of shift to apply to the value read from <Rm>. It must be one of:

ASR Arithmetic shift right, encoded as type = 0b10

LSL Logical shift left, encoded as type = 0b00

LSR Logical shift right, encoded as type = 0b01

ROR Rotate right, encoded as type = 0b11.

<Rs> The register whose bottom byte contains the amount to shift by.

The pre-UAL syntax ORR<C>S is equivalent to ORRS<C>.

Operation

```
if ConditionPassed() then
    EncodingSpecificOperations();
    shift_n = UInt(R[s]<7:0>);
    (shifted, carry) = Shift_C(R[m], shift_t, shift_n, APSR.C);
    result = R[n] OR shifted;
    R[d] = result;
    if setflags then
        APSR.N = result<31>;
        APSR.Z = IsZeroBit(result);
        APSR.C = carry;
        // APSR.V unchanged
```

Exceptions

None.

A8.6.116 PKH

Pack Halfword combines one halfword of its first operand with the other halfword of its shifted second operand.

Encoding T1 ARMv6T2, ARMv7

PKHBT<c> <Rd>, <Rn>, <Rm>{, LSL #<imm>}

PKHTB<c> <Rd>, <Rn>, <Rm>{, ASR #<imm>}

15	14	13	12	11	10	9	8	7	6	5	4	3	2	1	0	15	14	13	12	11	10	9	8	7	6	5	4	3	2	1	0
1	1	1	0	1	0	1	0	1	1	0	0	Rn				(0)	imm3			Rd			imm2		tb	0	Rm				

```
d = UInt(Rd); n = UInt(Rn); m = UInt(Rm); tbform = (tb == '1');
(shift_t, shift_n) = DecodeImmShift(tb:'0', imm3:imm2);
if BadReg(d) || BadReg(n) || BadReg(m) then UNPREDICTABLE;
```

Encoding A1 ARMv6*, ARMv7

PKHBT<c> <Rd>, <Rn>, <Rm>{, LSL #<imm>}

PKHTB<c> <Rd>, <Rn>, <Rm>{, ASR #<imm>}

31	30	29	28	27	26	25	24	23	22	21	20	19	18	17	16	15	14	13	12	11	10	9	8	7	6	5	4	3	2	1	0
cond		0	1	1	0	1	0	0	0	Rn				Rd				imm5			tb	0	1	Rm							

```
d = UInt(Rd); n = UInt(Rn); m = UInt(Rm); tbform = (tb == '1');
(shift_t, shift_n) = DecodeImmShift(tb:'0', imm5);
if d == 15 || n == 15 || m == 15 then UNPREDICTABLE;
```

Assembler syntax

PKHBT<c><q> {<Rd>,<Rn>, <Rm> {, LSL #<imm>}} tbform == FALSE
 PKHTB<c><q> {<Rd>,<Rn>, <Rm> {, ASR #<imm>}} tbform == TRUE

where:

<c><q> See *Standard assembler syntax fields* on page A8-7.

<Rd> The destination register.

<Rn> The first operand register.

<Rm> The register that is optionally shifted and used as the second operand.

<imm> The shift to apply to the value read from <Rm>, encoded in imm3:imm2 for encoding T1 and imm5 for encoding A1.

For PKHBT, it is one of:

omitted No shift, encoded as 0b00000

1-31 Left shift by specified number of bits, encoded as a binary number.

For PKHTB, it is one of:

omitted Instruction is a pseudo-instruction and is assembled as though PKHBT<c><q> <Rd>, <Rm>, <Rn> had been written

1-32 Arithmetic right shift by specified number of bits. A shift by 32 bits is encoded as 0b00000. Other shift amounts are encoded as binary numbers.

Note

An assembler can permit <imm> = 0 to mean the same thing as omitting the shift, but this is not standard UAL and must not be used for disassembly.

Operation

```
if ConditionPassed() then
    EncodingSpecificOperations();
    operand2 = Shift(R[m], shift_t, shift_n, APSR.C); // APSR.C ignored
    R[d]<15:0> = if tbform then operand2<15:0> else R[n]<15:0>;
    R[d]<31:16> = if tbform then R[n]<31:16>     else operand2<31:16>;
```

Exceptions

None.

A8.6.117 PLD, PLDW (immediate)

Preload Data signals the memory system that data memory accesses from a specified address are likely in the near future. The memory system can respond by taking actions that are expected to speed up the memory accesses when they do occur, such as pre-loading the cache line containing the specified address into the data cache. For more information, see *Behavior of Preload Data (PLD, PLDW) and Preload Instruction (PLI) with caches* on page B2-7.

On an architecture variant that includes both the PLD and PLDW instructions, the PLD instruction signals that the likely memory access is a read, and the PLDW instruction signals that it is a write.

Encoding T1 ARMv6T2, ARMv7 for PLD
 ARMv7 with MP Extensions for PLDW

PLD{W}<<c> [<Rn>, #<imm12>]

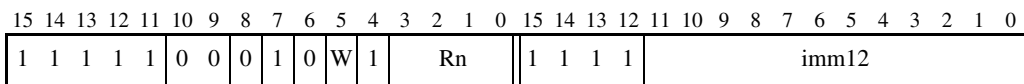

if Rn == '1111' then SEE PLD (literal);
 n = UInt(Rn); imm32 = ZeroExtend(imm12, 32); add = TRUE; is_pldw = (W == '1');

Encoding T2 ARMv6T2, ARMv7 for PLD
 ARMv7 with MP Extensions for PLDW

PLD{W}<<c> [<Rn>, #-<imm8>]

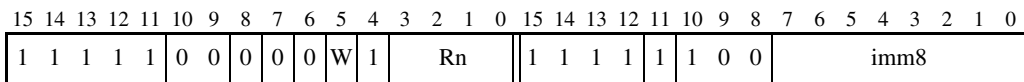

if Rn == '1111' then SEE PLD (literal);
 n = UInt(Rn); imm32 = ZeroExtend(imm8, 32); add = FALSE; is_pldw = (W == '1');

Encoding A1 ARMv5TE*, ARMv6*, ARMv7 for PLD
 ARMv7 with MP Extensions for PLDW

PLD{W} [<Rn>, #+/-<imm12>]

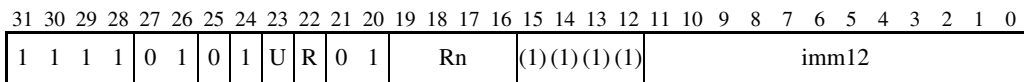

if Rn == '1111' then SEE PLD (literal);
 n = UInt(Rn); imm32 = ZeroExtend(imm12, 32); add = (U == '1'); is_pldw = (R == '0');

Assembler syntax

PLD{W}<C><q> [<Rn> {, #+/-<imm>}]

where:

W	If specified, selects PLDW, encoded as W = 1 in Thumb encodings and R = 0 in ARM encodings. If omitted, selects PLD, encoded as W = 0 in Thumb encodings and R = 1 in ARM encodings.				
<C><q>	See <i>Standard assembler syntax fields</i> on page A8-7. An ARM PLD or PLDW instruction must be unconditional.				
<Rn>	The base register. The SP can be used. For PC use in the PLD instruction, see <i>PLD (literal)</i> on page A8-238.				
+/-	Is + or omitted to indicate that the immediate offset is added to the base register value (add == TRUE), or – to indicate that the offset is to be subtracted (add == FALSE). Different instructions are generated for #0 and #-0.				
<imm>	The immediate offset used to form the address. This offset can be omitted, meaning an offset of 0. Values are: <table> <tr> <td>Encoding T1, A1</td> <td>any value in the range 0-4095</td> </tr> <tr> <td>Encoding T2</td> <td>any value in the range 0-255.</td> </tr> </table>	Encoding T1, A1	any value in the range 0-4095	Encoding T2	any value in the range 0-255.
Encoding T1, A1	any value in the range 0-4095				
Encoding T2	any value in the range 0-255.				

Operation

```

if ConditionPassed() then
    EncodingSpecificOperations();
    address = if add then (R[n] + imm32) else (R[n] - imm32);
    if is_pldw then
        Hint_PreloadDataForWrite(address);
    else
        Hint_PreloadData(address);

```

Exceptions

None.

A8.6.118 PLD (literal)

Preload Data signals the memory system that data memory accesses from a specified address are likely in the near future. The memory system can respond by taking actions that are expected to speed up the memory accesses when they do occur, such as pre-loading the cache line containing the specified address into the data cache. For more information, see *Behavior of Preload Data (PLD, PLDW) and Preload Instruction (PLI) with caches* on page B2-7.

Encoding T1 ARMv6T2, ARMv7

PLD<C> <label>

PLD<C> [PC, #-0] Special case

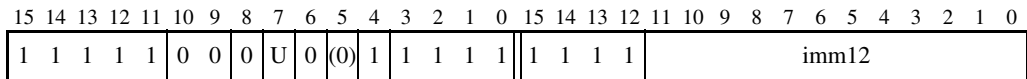

imm32 = ZeroExtend(imm12, 32); add = (U == '1');

Encoding A1 ARMv5TE*, ARMv6*, ARMv7

PLD <label>

PLD [PC, #-0] Special case

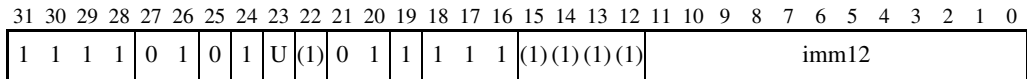

imm32 = ZeroExtend(imm12, 32); add = (U == '1');

Assembler syntax

PLD<c><q> <label>	Normal form
PLD<c><q> [PC, #+/-<imm>]	Alternative form

where:

<c><q>	See <i>Standard assembler syntax fields</i> on page A8-7. An ARM PLD instruction must be unconditional.
<label>	The label of the literal data item that is likely to be accessed in the near future. The assembler calculates the required value of the offset from the <code>Align(PC,4)</code> value of this instruction to the label. The offset must be in the range -4095 to 4095 . If the offset is zero or positive, <code>imm32</code> is equal to the offset and <code>add == TRUE</code> . If the offset is negative, <code>imm32</code> is equal to minus the offset and <code>add == FALSE</code> .
+/-	Is <code>+</code> or omitted to indicate that the immediate offset is added to the <code>Align(PC,4)</code> value (<code>add == TRUE</code>), or <code>-</code> to indicate that the offset is to be subtracted (<code>add == FALSE</code>). Different instructions are generated for <code>#0</code> and <code>#-0</code> .
<imm>	The immediate offset used to form the address. Values are in the range $0-4095$.

The alternative syntax permits the addition or subtraction of the offset and the immediate offset to be specified separately, including permitting a subtraction of 0 that cannot be specified using the normal syntax. For more information, see *Use of labels in UAL instruction syntax* on page A4-5.

Operation

```
if ConditionPassed() then
    EncodingSpecificOperations();
    address = if add then (Align(PC,4) + imm32) else (Align(PC,4) - imm32);
    Hint_PreloadData(address);
```

Exceptions

None.

A8.6.119 PLD, PLDW (register)

Preload Data signals the memory system that data memory accesses from a specified address are likely in the near future. The memory system can respond by taking actions that are expected to speed up the memory accesses when they do occur, such as pre-loading the cache line containing the specified address into the data cache. For more information, see *Behavior of Preload Data (PLD, PLDW) and Preload Instruction (PLI) with caches* on page B2-7.

On an architecture variant that includes both the PLD and PLDW instructions, the PLD instruction signals that the likely memory access is a read, and the PLDW instruction signals that it is a write.

Encoding T1 ARMv6T2, ARMv7 for PLD
 ARMv7 with MP Extensions for PLDW

PLD{W}<C> [<Rn>, <Rm>{, LSL #<imm2>}]

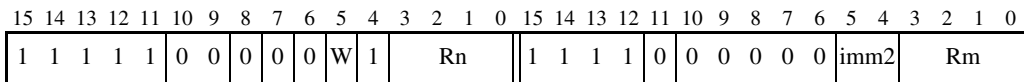

```

if Rn == '1111' then SEE PLD (literal);
n = UInt(Rn); m = UInt(Rm); add = TRUE; is_pldw = (W == '1');
(shift_t, shift_n) = (SRTYPE_LSL, UInt(imm2));
if BadReg(m) then UNPREDICTABLE;
    
```

Encoding A1 ARMv5TE*, ARMv6*, ARMv7 for PLD
 ARMv7 with MP Extensions for PLDW

PLD{W}<C> [<Rn>, +/-<Rm>{, <shift>}]

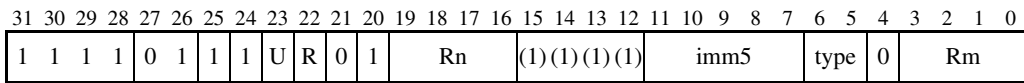

```

n = UInt(Rn); m = UInt(Rm); add = (U == '1'); is_pldw = (R == '0');
(shift_t, shift_n) = DecodeImmShift(type, imm5);
if m == 15 then UNPREDICTABLE;
    
```

Assembler syntax

```
PLD[W]<C><Q> [<Rn>, +/-<Rm> {, <shift>}]
```

where:

W	If specified, selects PLDW, encoded as W = 1 in Thumb encodings and R = 0 in ARM encodings. If omitted, selects PLD, encoded as W = 0 in Thumb encodings and R = 1 in ARM encodings.
<C><Q>	See <i>Standard assembler syntax fields</i> on page A8-7. An ARM PLD or PLDW instruction must be unconditional.
<Rn>	Is the base register. The SP can be used.
+/-	Is + or omitted if the optionally shifted value of <Rm> is to be added to the base register value (add == TRUE), or – if it is to be subtracted (permitted in ARM code only, add == FALSE).
<Rm>	Contains the offset that is optionally shifted and applied to the value of <Rn> to form the address.
<shift>	The shift to apply to the value read from <Rm>. If absent, no shift is applied. For encoding T1, <shift> can only be omitted, encoded as imm2 = 0b00, or LSL #<imm> with <imm> = 1, 2, or 3, with <imm> encoded in imm2. For encoding A1, see <i>Shifts applied to a register</i> on page A8-10.

Operation

```
if ConditionPassed() then
    EncodingSpecificOperations();
    offset = Shift(R[m], shift_t, shift_n, APSR.C);
    address = if add then (R[n] + offset) else (R[n] - offset);
    if is_pldw then
        Hint_PreloadDataForWrite(address);
    else
        Hint_PreloadData(address);
```

Exceptions

None.

A8.6.120 PLI (immediate, literal)

Preload Instruction signals the memory system that instruction memory accesses from a specified address are likely in the near future. The memory system can respond by taking actions that are expected to speed up the memory accesses when they do occur, such as pre-loading the cache line containing the specified address into the instruction cache. For more information, see *Behavior of Preload Data (PLD, PLDW) and Preload Instruction (PLI) with caches* on page B2-7.

Encoding T1 ARMv7

PLI<c> [<Rn>, #<imm12>]

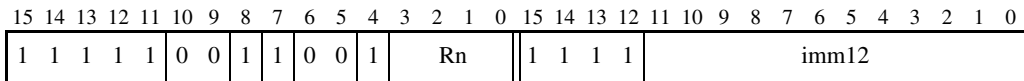

if Rn == '1111' then SEE encoding T3;
n = UInt(Rn); imm32 = ZeroExtend(imm12, 32); add = TRUE;

Encoding T2 ARMv7

PLI<c> [<Rn>, #-<imm8>]

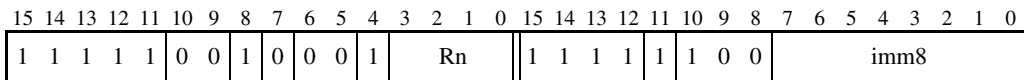

if Rn == '1111' then SEE encoding T3;
n = UInt(Rn); imm32 = ZeroExtend(imm8, 32); add = FALSE;

Encoding T3 ARMv7

PLI<c> <label>

PLI<c> [PC, #-0]

Special case

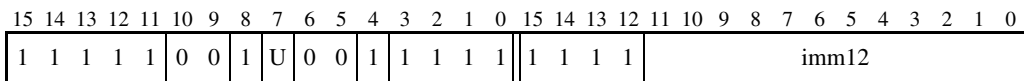

n = 15; imm32 = ZeroExtend(imm12, 32); add = (U == '1');

Encoding A1 ARMv7

PLI [<Rn>, #+/-<imm12>]

PLI <label>

PLI [PC, #-0]

Special case

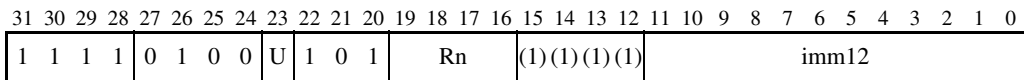

n = UInt(Rn); imm32 = ZeroExtend(imm12, 32); add = (U == '1');

Assembler syntax

PLI<C><q> [<Rn> {, #+/-<imm>}]	Immediate form
PLI<C><q> <label>	Normal literal form
PLI<C><q> [PC, #+/-<imm>]	Alternative literal form

where:

<C><q>	See <i>Standard assembler syntax fields</i> on page A8-7. An ARM PLI instruction must be unconditional.
<Rn>	Is the base register. The SP can be used.
+/-	Is + or omitted to indicate that the immediate offset is added to the base register value (add == TRUE), or – to indicate that the offset is to be subtracted (add == FALSE). Different instructions are generated for #0 and #-0.
<imm>	The immediate offset used to form the address. For the immediate form of the syntax, <imm> can be omitted, in which case the #0 form of the instruction is assembled. Values are: Encoding T1, T3, A1 any value in the range 0 to 4095 Encoding T2 any value in the range 0 to 255.
<label>	The label of the instruction that is likely to be accessed in the near future. The assembler calculates the required value of the offset from the Align(PC,4) value of this instruction to the label. The offset must be in the range –4095 to 4095. If the offset is zero or positive, imm32 is equal to the offset and add == TRUE. If the offset is negative, imm32 is equal to minus the offset and add == FALSE.

For the literal forms of the instruction, encoding T3 is used, or Rn is encoded as '1111' in encoding A1, to indicate that the PC is the base register.

The alternative literal syntax permits the addition or subtraction of the offset and the immediate offset to be specified separately, including permitting a subtraction of 0 that cannot be specified using the normal syntax. For more information, see *Use of labels in UAL instruction syntax* on page A4-5.

Operation

```

if ConditionPassed() then
    EncodingSpecificOperations();
    base = if n == 15 then Align(PC,4) else R[n];
    address = if add then (base + imm32) else (base - imm32);
    Hint_PreloadInstr(address);

```

Exceptions

None.

A8.6.121 PLI (register)

Preload Instruction signals the memory system that instruction memory accesses from a specified address are likely in the near future. The memory system can respond by taking actions that are expected to speed up the memory accesses when they do occur, such as pre-loading the cache line containing the specified address into the instruction cache. For more information, see *Behavior of Preload Data (PLD, PLDW) and Preload Instruction (PLI) with caches* on page B2-7.

Encoding T1 ARMv7

PLI<c> [<Rn>, <Rm>{, LSL #<imm2>}]

15	14	13	12	11	10	9	8	7	6	5	4	3	2	1	0	15	14	13	12	11	10	9	8	7	6	5	4	3	2	1	0
1	1	1	1	1	0	0	1	0	0	0	1	Rn				1	1	1	1	0	0	0	0	0	0	imm2	Rm				

```

if Rn == '1111' then SEE PLI (immediate, literal);
n = UInt(Rn); m = UInt(Rm); add = TRUE;
(shift_t, shift_n) = (SRTYPE_LSL, UInt(imm2));
if BadReg(m) then UNPREDICTABLE;
    
```

Encoding A1 ARMv7

PLI [<Rn>, +/-<Rm>{, <shift>}]

31	30	29	28	27	26	25	24	23	22	21	20	19	18	17	16	15	14	13	12	11	10	9	8	7	6	5	4	3	2	1	0
1	1	1	1	0	1	1	0	U	1	0	1	Rn				(1)	(1)	(1)	(1)	imm5				type	0	Rm					

```

n = UInt(Rn); m = UInt(Rm); add = (U == '1');
(shift_t, shift_n) = DecodeImmShift(type, imm5);
if m == 15 then UNPREDICTABLE;
    
```

Assembler syntax

PLI<c><q> [<Rn>, +/-<Rm> {, <shift>}]

where:

<c><q>	See <i>Standard assembler syntax fields</i> on page A8-7. An ARM PLI instruction must be unconditional.
<Rn>	Is the base register. The SP can be used.
+/-	Is + or omitted if the optionally shifted value of <Rm> is to be added to the base register value (add == TRUE), or – if it is to be subtracted (permitted in ARM code only, add == FALSE).
<Rm>	Contains the offset that is optionally shifted and applied to the value of <Rn> to form the address.
<shift>	The shift to apply to the value read from <Rm>. If absent, no shift is applied. For encoding T1, <shift> can only be omitted, encoded as imm2 = 0b00, or LSL #<imm> with <imm> = 1, 2, or 3, with <imm> encoded in imm2. For encoding A1, see <i>Shifts applied to a register</i> on page A8-10.

Operation

```
if ConditionPassed() then
    EncodingSpecificOperations();
    offset = Shift(R[m], shift_t, shift_n, APSR.C);
    address = if add then (R[n] + offset) else (R[n] - offset);
    Hint_PreloadInstr(address);
```

Exceptions

None.

A8.6.122 POP

Pop Multiple Registers loads multiple registers from the stack, loading from consecutive memory locations starting at the address in SP, and updates SP to point just above the loaded data.

Encoding T1 ARMv4T, ARMv5T*, ARMv6*, ARMv7

POP<c> <registers>

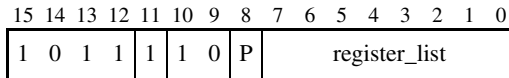

registers = P:'000000':register_list; if BitCount(registers) < 1 then UNPREDICTABLE;

Encoding T2 ARMv6T2, ARMv7

POP<c>.W <registers> <registers> contains more than one register

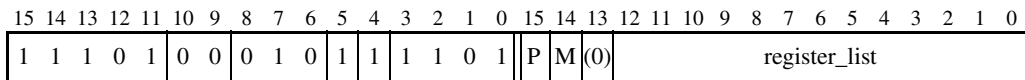

registers = P:M:'0':register_list;
 if BitCount(registers) < 2 || (P == '1' && M == '1') then UNPREDICTABLE;
 if registers<15> == '1' && InITBlock() && !LastInITBlock() then UNPREDICTABLE;

Encoding T3 ARMv6T2, ARMv7

POP<c>.W <registers> <registers> contains one register, <Rt>

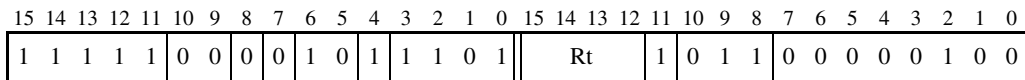

t = UInt(Rt); registers = Zeros(16); registers<t> = '1';
 if t == 13 || (t == 15 && InITBlock() && !LastInITBlock()) then UNPREDICTABLE;

Encoding A1 ARMv4*, ARMv5T*, ARMv6*, ARMv7

POP<c> <registers> <registers> contains more than one register

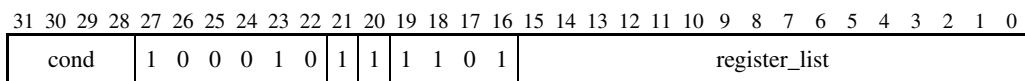

if BitCount(register_list) < 2 then SEE LDM / LDMIA / LDMFD;
 registers = register_list;
 if registers<13> == '1' && ArchVersion() >= 7 then UNPREDICTABLE;

Encoding A2 ARMv4*, ARMv5T*, ARMv6*, ARMv7

POP<c> <registers> <registers> contains one register, <Rt>

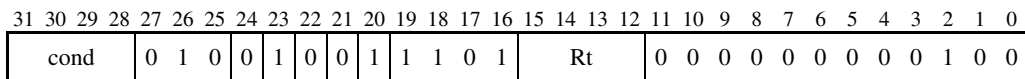

t = UInt(Rt); registers = Zeros(16); registers<t> = '1';
 if t == 13 then UNPREDICTABLE;

Assembler syntax

POP<c><q> <registers> Standard syntax
 LDM<c><q> SP!, <registers> Equivalent LDM syntax

where:

<c><q> See *Standard assembler syntax fields* on page A8-7.

<registers> Is a list of one or more registers to be loaded, separated by commas and surrounded by { and }. The lowest-numbered register is loaded from the lowest memory address, through to the highest-numbered register from the highest memory address.

If the list contains more than one register, the instruction is assembled to encoding T1, T2, or A1. If the list contains exactly one register, the instruction is assembled to encoding T1, T3, or A2.

The SP can only be in the list in ARM code before ARMv7. ARM instructions that include the SP in the list are deprecated, and the value of the SP after such an instruction is UNKNOWN.

The PC can be in the list. If it is, the instruction branches to the address loaded to the PC. In ARMv5T and above, this is an interworking branch, see *Pseudocode details of operations on ARM core registers* on page A2-12. In Thumb code, if the PC is in the list:

- the LR must not be in the list
- the instruction must be either outside any IT block, or the last instruction in an IT block.

ARM instructions that include both the LR and the PC in the list are deprecated.

Operation

```
if ConditionPassed() then
  EncodingSpecificOperations(); NullCheckIfThumbEE(13);
  address = SP;
  for i = 0 to 14
    if registers<i> == '1' then
      R[i] = MemA[address,4]; address = address + 4;
  if registers<15> == '1' then
    LoadWritePC(MemA[address,4]);
  if registers<13> == '0' then SP = SP + 4*BitCount(registers);
  if registers<13> == '1' then SP = bits(32) UNKNOWN;
```

Exceptions

Data Abort.

A8.6.123 PUSH

Push Multiple Registers stores multiple registers to the stack, storing to consecutive memory locations ending just below the address in SP, and updates SP to point to the start of the stored data.

Encoding T1 ARMv4T, ARMv5T*, ARMv6*, ARMv7

PUSH<c> <registers>

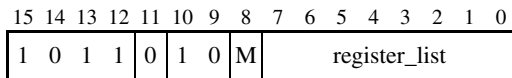

```
registers = '0':M:'000000':register_list;
if BitCount(registers) < 1 then UNPREDICTABLE;
```

Encoding T2 ARMv6T2, ARMv7

PUSH<c>.W <registers> <registers> contains more than one register

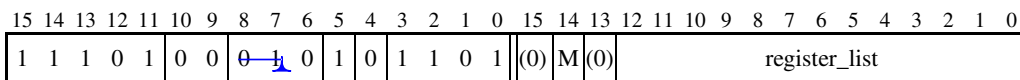

```
registers = '0':M:'0':register_list;
if BitCount(registers) < 2 then UNPREDICTABLE;
```

Encoding T3 ARMv6T2, ARMv7

PUSH<c>.W <registers> <registers> contains one register, <Rt>

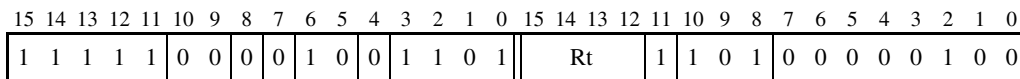

```
t = UInt(Rt); registers = Zeros(16); registers<t> = '1';
if BadReg(t) then UNPREDICTABLE;
```

Encoding A1 ARMv4*, ARMv5T*, ARMv6*, ARMv7

PUSH<c> <registers> <registers> contains more than one register

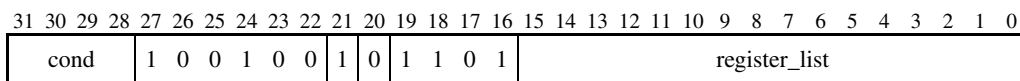

```
if BitCount(register_list) < 2 then SEE STMDB / STMTD;
registers = register_list;
```

Encoding A2 ARMv4*, ARMv5T*, ARMv6*, ARMv7

PUSH<c> <registers> <registers> contains one register, <Rt>

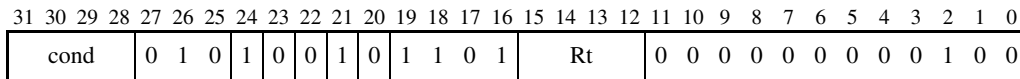

```
t = UInt(Rt); registers = Zeros(16); registers<t> = '1';
if t == 13 then UNPREDICTABLE;
```

Assembler syntax

PUSH<c><q> <registers> Standard syntax
 STMDB<c><q> SP!, <registers> Equivalent STM syntax

where:

<c><q> See *Standard assembler syntax fields* on page A8-7.

<registers> Is a list of one or more registers to be stored, separated by commas and surrounded by { and }. The lowest-numbered register is stored to the lowest memory address, through to the highest-numbered register to the highest memory address.

If the list contains more than one register, the instruction is assembled to encoding T1, T2, or A1. If the list contains exactly one register, the instruction is assembled to encoding T1, T3, or A2.

The SP and PC can be in the list in ARM code, but not in Thumb code. However, ARM instructions that include the SP or the PC in the list are deprecated, and if the SP is in the list, the value the instruction stores for the SP is UNKNOWN.

Operation

```
if ConditionPassed() then
    EncodingSpecificOperations(); NullCheckIfThumbEE(13);
    address = SP - 4*BitCount(registers);
    for i = 0 to 14
        if registers<i> == '1' then
            if i == 13 && i != LowestSetBit(registers) then // Only possible for encoding A1
                MemA[address,4] = bits(32) UNKNOWN;
            else
                MemA[address,4] = R[i];
                address = address + 4;
        if registers<15> == '1' then // Only possible for encoding A1 or A2
            MemA[address,4] = PCStoreValue();
    SP = SP - 4*BitCount(registers);
```

Exceptions

Data Abort.

A8.6.124 QADD

Saturating Add adds two register values, saturates the result to the 32-bit signed integer range $-2^{31} \leq x \leq 2^{31} - 1$, and writes the result to the destination register. If saturation occurs, it sets the Q flag in the APSR.

Encoding T1 ARMv6T2, ARMv7

QADD<c> <Rd>, <Rm>, <Rn>

15	14	13	12	11	10	9	8	7	6	5	4	3	2	1	0	15	14	13	12	11	10	9	8	7	6	5	4	3	2	1	0
1	1	1	1	1	0	1	0	1	0	0	0	Rn				1	1	1	1	Rd				1	0	0	0	Rm			

d = UInt(Rd); n = UInt(Rn); m = UInt(Rm);
 if BadReg(d) || BadReg(n) || BadReg(m) then UNPREDICTABLE;

Encoding A1 ARMv5TE*, ARMv6*, ARMv7

QADD<c> <Rd>, <Rm>, <Rn>

31	30	29	28	27	26	25	24	23	22	21	20	19	18	17	16	15	14	13	12	11	10	9	8	7	6	5	4	3	2	1	0
cond		0	0	0	1	0	0	0	0	Rn				Rd				(0)	(0)	(0)	(0)	0	1	0	1	Rm					

d = UInt(Rd); n = UInt(Rn); m = UInt(Rm);
 if d == 15 || n == 15 || m == 15 then UNPREDICTABLE;

Assembler syntax

QADD<c><q> {<Rd>}, <Rm>, <Rn>

where:

<c><q> See *Standard assembler syntax fields* on page A8-7.

<Rd> The destination register.

<Rm> The first operand register.

<Rn> The second operand register.

Operation

```

if ConditionPassed() then
    EncodingSpecificOperations();
    (R[d], sat) = SignedSatQ(SInt(R[m]) + SInt(R[n]), 32);
    if sat then
        APSR.Q = '1';

```

Exceptions

None.

A8.6.125 QADD16

Saturating Add 16 performs two 16-bit integer additions, saturates the results to the 16-bit signed integer range $-2^{15} \leq x \leq 2^{15} - 1$, and writes the results to the destination register.

Encoding T1 ARMv6T2, ARMv7

QADD16<c> <Rd>, <Rn>, <Rm>

15	14	13	12	11	10	9	8	7	6	5	4	3	2	1	0	15	14	13	12	11	10	9	8	7	6	5	4	3	2	1	0
1	1	1	1	1	0	1	0	1	0	0	1	Rn				1	1	1	1	Rd				0	0	0	1	Rm			

d = UInt(Rd); n = UInt(Rn); m = UInt(Rm);
 if BadReg(d) || BadReg(n) || BadReg(m) then UNPREDICTABLE;

Encoding A1 ARMv6*, ARMv7

QADD16<c> <Rd>, <Rn>, <Rm>

31	30	29	28	27	26	25	24	23	22	21	20	19	18	17	16	15	14	13	12	11	10	9	8	7	6	5	4	3	2	1	0
cond		0	1	1	0	0	0	1	0	Rn				Rd				(1)	(1)	(1)	(1)	0	0	0	1	Rm					

d = UInt(Rd); n = UInt(Rn); m = UInt(Rm);
 if d == 15 || n == 15 || m == 15 then UNPREDICTABLE;

Assembler syntax

QADD16<c><q> {<Rd>}, <Rn>, <Rm>

where:

<c><q> See *Standard assembler syntax fields* on page A8-7.

<Rd> The destination register.

<Rn> The first operand register.

<Rm> The second operand register.

Operation

```
if ConditionPassed() then
    EncodingSpecificOperations();
    sum1 = SInt(R[n]<15:0>) + SInt(R[m]<15:0>);
    sum2 = SInt(R[n]<31:16>) + SInt(R[m]<31:16>);
    R[d]<15:0> = SignedSat(sum1, 16);
    R[d]<31:16> = SignedSat(sum2, 16);
```

Exceptions

None.

A8.6.126 QADD8

Saturating Add 8 performs four 8-bit integer additions, saturates the results to the 8-bit signed integer range $-2^7 \leq x \leq 2^7 - 1$, and writes the results to the destination register.

Encoding T1 ARMv6T2, ARMv7

QADD8<c> <Rd>, <Rn>, <Rm>

15	14	13	12	11	10	9	8	7	6	5	4	3	2	1	0	15	14	13	12	11	10	9	8	7	6	5	4	3	2	1	0
1	1	1	1	1	0	1	0	1	0	0	0	Rn				1	1	1	1	Rd	0	0	0	1	Rm						

d = UInt(Rd); n = UInt(Rn); m = UInt(Rm);
 if BadReg(d) || BadReg(n) || BadReg(m) then UNPREDICTABLE;

Encoding A1 ARMv6*, ARMv7

QADD8<c> <Rd>, <Rn>, <Rm>

31	30	29	28	27	26	25	24	23	22	21	20	19	18	17	16	15	14	13	12	11	10	9	8	7	6	5	4	3	2	1	0
cond	0	1	1	0	0	0	1	0	Rn	Rd	(1)	(1)	(1)	(1)	1	0	0	1	Rm												

d = UInt(Rd); n = UInt(Rn); m = UInt(Rm);
 if d == 15 || n == 15 || m == 15 then UNPREDICTABLE;

Assembler syntax

QADD8<c><q> {<Rd>}, <Rn>, <Rm>

where:

<c><q> See *Standard assembler syntax fields* on page A8-7.

<Rd> The destination register.

<Rn> The first operand register.

<Rm> The second operand register.

Operation

```
if ConditionPassed() then
    EncodingSpecificOperations();
    sum1 = SInt(R[n]<7:0>) + SInt(R[m]<7:0>);
    sum2 = SInt(R[n]<15:8>) + SInt(R[m]<15:8>);
    sum3 = SInt(R[n]<23:16>) + SInt(R[m]<23:16>);
    sum4 = SInt(R[n]<31:24>) + SInt(R[m]<31:24>);
    R[d]<7:0> = SignedSat(sum1, 8);
    R[d]<15:8> = SignedSat(sum2, 8);
    R[d]<23:16> = SignedSat(sum3, 8);
    R[d]<31:24> = SignedSat(sum4, 8);
```

Exceptions

None.

A8.6.127 QASX

Saturating Add and Subtract with Exchange exchanges the two halfwords of the second operand, performs one 16-bit integer addition and one 16-bit subtraction, saturates the results to the 16-bit signed integer range $-2^{15} \leq x \leq 2^{15} - 1$, and writes the results to the destination register.

Encoding T1 ARMv6T2, ARMv7

QASX<c> <Rd>, <Rn>, <Rm>

15	14	13	12	11	10	9	8	7	6	5	4	3	2	1	0	15	14	13	12	11	10	9	8	7	6	5	4	3	2	1	0
1	1	1	1	1	0	1	0	1	0	1	0	Rn				1	1	1	1	Rd				0	0	0	1	Rm			

d = UInt(Rd); n = UInt(Rn); m = UInt(Rm);
 if BadReg(d) || BadReg(n) || BadReg(m) then UNPREDICTABLE;

Encoding A1 ARMv6*, ARMv7

QASX<c> <Rd>, <Rn>, <Rm>

31	30	29	28	27	26	25	24	23	22	21	20	19	18	17	16	15	14	13	12	11	10	9	8	7	6	5	4	3	2	1	0
cond		0	1	1	0	0	0	1	0	Rn				Rd				(1)	(1)	(1)	(1)	0	0	1	1	Rm					

d = UInt(Rd); n = UInt(Rn); m = UInt(Rm);
 if d == 15 || n == 15 || m == 15 then UNPREDICTABLE;

Assembler syntax

QASX<c><q> {<Rd>}, <Rn>, <Rm>

where:

<c><q> See *Standard assembler syntax fields* on page A8-7.

<Rd> The destination register.

<Rn> The first operand register.

<Rm> The second operand register.

The pre-UAL syntax QADDSUBX<c> is equivalent to QASX<c>.

Operation

```
if ConditionPassed() then
    EncodingSpecificOperations();
    diff = SInt(R[n]<15:0>) - SInt(R[m]<31:16>);
    sum = SInt(R[n]<31:16>) + SInt(R[m]<15:0>);
    R[d]<15:0> = SignedSat(diff, 16);
    R[d]<31:16> = SignedSat(sum, 16);
```

Exceptions

None.

A8.6.128 QDADD

Saturating Double and Add adds a doubled register value to another register value, and writes the result to the destination register. Both the doubling and the addition have their results saturated to the 32-bit signed integer range $-2^{31} \leq x \leq 2^{31} - 1$. If saturation occurs in either operation, it sets the Q flag in the APSR.

Encoding T1 ARMv6T2, ARMv7

QDADD<c> <Rd>, <Rm>, <Rn>

15	14	13	12	11	10	9	8	7	6	5	4	3	2	1	0	15	14	13	12	11	10	9	8	7	6	5	4	3	2	1	0
1	1	1	1	1	0	1	0	1	0	0	0	Rn				1	1	1	1	Rd				1	0	0	1	Rm			

d = UInt(Rd); n = UInt(Rn); m = UInt(Rm);
 if BadReg(d) || BadReg(n) || BadReg(m) then UNPREDICTABLE;

Encoding A1 ARMv5TE*, ARMv6*, ARMv7

QDADD<c> <Rd>, <Rm>, <Rn>

31	30	29	28	27	26	25	24	23	22	21	20	19	18	17	16	15	14	13	12	11	10	9	8	7	6	5	4	3	2	1	0
cond		0	0	0	1	0	1	0	0	Rn				Rd				(0)	(0)	(0)	(0)	0	1	0	1	Rm					

d = UInt(Rd); n = UInt(Rn); m = UInt(Rm);
 if d == 15 || n == 15 || m == 15 then UNPREDICTABLE;

Assembler syntax

QDADD<c><q> {<Rd>}, <Rm>, <Rn>

where:

<c><q> See *Standard assembler syntax fields* on page A8-7.

<Rd> The destination register.

<Rm> The first operand register.

<Rn> The second operand register.

Operation

```
if ConditionPassed() then
    EncodingSpecificOperations();
    (doubled, sat1) = SignedSatQ(2 * SInt(R[n]), 32);
    (R[d], sat2) = SignedSatQ(SInt(R[m]) + SInt(doubled), 32);
    if sat1 || sat2 then
        APSR.Q = '1';
```

Exceptions

None.

A8.6.129 QDSUB

Saturating Double and Subtract subtracts a doubled register value from another register value, and writes the result to the destination register. Both the doubling and the subtraction have their results saturated to the 32-bit signed integer range $-2^{31} \leq x \leq 2^{31} - 1$. If saturation occurs in either operation, it sets the Q flag in the APSR.

Encoding T1 ARMv6T2, ARMv7

QDSUB<c> <Rd>, <Rm>, <Rn>

15	14	13	12	11	10	9	8	7	6	5	4	3	2	1	0	15	14	13	12	11	10	9	8	7	6	5	4	3	2	1	0
1	1	1	1	1	0	1	0	1	0	0	0	Rn				1	1	1	1	Rd				1	0	1	1	Rm			

d = UInt(Rd); n = UInt(Rn); m = UInt(Rm);
 if BadReg(d) || BadReg(n) || BadReg(m) then UNPREDICTABLE;

Encoding A1 ARMv5TE*, ARMv6*, ARMv7

QDSUB<c> <Rd>, <Rm>, <Rn>

31	30	29	28	27	26	25	24	23	22	21	20	19	18	17	16	15	14	13	12	11	10	9	8	7	6	5	4	3	2	1	0
cond		0	0	0	1	0	1	1	0	Rn				Rd				(0)	(0)	(0)	(0)	0	1	0	1	Rm					

d = UInt(Rd); n = UInt(Rn); m = UInt(Rm);
 if d == 15 || n == 15 || m == 15 then UNPREDICTABLE;

Assembler syntax

QDSUB<c><q> {<Rd>}, <Rm>, <Rn>

where:

<c><q> See *Standard assembler syntax fields* on page A8-7.

<Rd> The destination register.

<Rm> The first operand register.

<Rn> The second operand register.

Operation

```
if ConditionPassed() then
    EncodingSpecificOperations();
    (doubled, sat1) = SignedSatQ(2 * SInt(R[n]), 32);
    (R[d], sat2) = SignedSatQ(SInt(R[m]) - SInt(doubled), 32);
    if sat1 || sat2 then
        APSR.Q = '1';
```

Exceptions

None.

A8.6.130 QSAX

Saturating Subtract and Add with Exchange exchanges the two halfwords of the second operand, performs one 16-bit integer subtraction and one 16-bit addition, saturates the results to the 16-bit signed integer range $-2^{15} \leq x \leq 2^{15} - 1$, and writes the results to the destination register.

Encoding T1 ARMv6T2, ARMv7

QSAX<c> <Rd>, <Rn>, <Rm>

15	14	13	12	11	10	9	8	7	6	5	4	3	2	1	0	15	14	13	12	11	10	9	8	7	6	5	4	3	2	1	0
1	1	1	1	1	0	1	0	1	1	1	0	Rn				1	1	1	1	Rd				0	0	0	1	Rm			

d = UInt(Rd); n = UInt(Rn); m = UInt(Rm);
 if BadReg(d) || BadReg(n) || BadReg(m) then UNPREDICTABLE;

Encoding A1 ARMv6*, ARMv7

QSAX<c> <Rd>, <Rn>, <Rm>

31	30	29	28	27	26	25	24	23	22	21	20	19	18	17	16	15	14	13	12	11	10	9	8	7	6	5	4	3	2	1	0
cond		0	1	1	0	0	0	1	0	Rn				Rd				(1)	(1)	(1)	(1)	0	1	0	1	Rm					

d = UInt(Rd); n = UInt(Rn); m = UInt(Rm);
 if d == 15 || n == 15 || m == 15 then UNPREDICTABLE;

Assembler syntax

QSAX<c><q> {<Rd>}, <Rn>, <Rm>

where:

<c><q> See *Standard assembler syntax fields* on page A8-7.

<Rd> The destination register.

<Rn> The first operand register.

<Rm> The second operand register.

The pre-UAL syntax QSUBADDX<c> is equivalent to QSAX<c>.

Operation

```
if ConditionPassed() then
    EncodingSpecificOperations();
    diff = SInt(R[n]<15:0>) - SInt(R[m]<31:16>);
    sum  = SInt(R[n]<31:16>) + SInt(R[m]<15:0>);
    R[d]<15:0> = SignedSat(diff, 16);
    R[d]<31:16> = SignedSat(sum, 16);
```

Exceptions

None.

A8.6.131 QSUB

Saturating Subtract subtracts one register value from another register value, saturates the result to the 32-bit signed integer range $-2^{31} \leq x \leq 2^{31} - 1$, and writes the result to the destination register. If saturation occurs, it sets the Q flag in the APSR.

Encoding T1 ARMv6T2, ARMv7

QSUB<c> <Rd>, <Rm>, <Rn>

15	14	13	12	11	10	9	8	7	6	5	4	3	2	1	0	15	14	13	12	11	10	9	8	7	6	5	4	3	2	1	0
1	1	1	1	1	0	1	0	1	0	0	0	Rn				1	1	1	1	Rd				1	0	1	0	Rm			

d = UInt(Rd); n = UInt(Rn); m = UInt(Rm);
 if BadReg(d) || BadReg(n) || BadReg(m) then UNPREDICTABLE;

Encoding A1 ARMv5TE*, ARMv6*, ARMv7

QSUB<c> <Rd>, <Rm>, <Rn>

31	30	29	28	27	26	25	24	23	22	21	20	19	18	17	16	15	14	13	12	11	10	9	8	7	6	5	4	3	2	1	0
cond		0	0	0	1	0	0	1	0	Rn				Rd				(0)	(0)	(0)	(0)	0	1	0	1	Rm					

d = UInt(Rd); n = UInt(Rn); m = UInt(Rm);
 if d == 15 || n == 15 || m == 15 then UNPREDICTABLE;

Assembler syntax

QSUB<c><q> {<Rd>}, <Rm>, <Rn>

where:

<c><q> See *Standard assembler syntax fields* on page A8-7.

<Rd> The destination register.

<Rm> The first operand register.

<Rn> The second operand register.

Operation

```
if ConditionPassed() then
    EncodingSpecificOperations();
    (R[d], sat) = SignedSatQ(SInt(R[m]) - SInt(R[n]), 32);
    if sat then
        APSR.Q = '1';
```

Exceptions

None.

A8.6.132 QSUB16

Saturating Subtract 16 performs two 16-bit integer subtractions, saturates the results to the 16-bit signed integer range $-2^{15} \leq x \leq 2^{15} - 1$, and writes the results to the destination register.

Encoding T1 ARMv6T2, ARMv7

QSUB16<c> <Rd>, <Rn>, <Rm>

15	14	13	12	11	10	9	8	7	6	5	4	3	2	1	0	15	14	13	12	11	10	9	8	7	6	5	4	3	2	1	0
1	1	1	1	1	0	1	0	1	1	0	1	Rn				1	1	1	1	Rd	0	0	0	1	Rm						

d = UInt(Rd); n = UInt(Rn); m = UInt(Rm);
 if BadReg(d) || BadReg(n) || BadReg(m) then UNPREDICTABLE;

Encoding A1 ARMv6*, ARMv7

QSUB16<c> <Rd>, <Rn>, <Rm>

31	30	29	28	27	26	25	24	23	22	21	20	19	18	17	16	15	14	13	12	11	10	9	8	7	6	5	4	3	2	1	0
cond		0	1	1	0	0	0	1	0	Rn	Rd	(1)	(1)	(1)	(1)	0	1	1	1	Rm											

d = UInt(Rd); n = UInt(Rn); m = UInt(Rm);
 if d == 15 || n == 15 || m == 15 then UNPREDICTABLE;

Assembler syntax

QSUB16<c><q> {<Rd>}, <Rn>, <Rm>

where:

<c><q> See *Standard assembler syntax fields* on page A8-7.

<Rd> The destination register.

<Rn> The first operand register.

<Rm> The second operand register.

Operation

```
if ConditionPassed() then
    EncodingSpecificOperations();
    diff1 = SInt(R[n]<15:0>) - SInt(R[m]<15:0>);
    diff2 = SInt(R[n]<31:16>) - SInt(R[m]<31:16>);
    R[d]<15:0> = SignedSat(diff1, 16);
    R[d]<31:16> = SignedSat(diff2, 16);
```

Exceptions

None.

A8.6.133 QSUB8

Saturating Subtract 8 performs four 8-bit integer subtractions, saturates the results to the 8-bit signed integer range $-2^7 \leq x \leq 2^7 - 1$, and writes the results to the destination register.

Encoding T1 ARMv6T2, ARMv7

QSUB8<c> <Rd>, <Rn>, <Rm>

15	14	13	12	11	10	9	8	7	6	5	4	3	2	1	0	15	14	13	12	11	10	9	8	7	6	5	4	3	2	1	0
1	1	1	1	1	0	1	0	1	1	0	0	Rn				1	1	1	1	Rd	0	0	0	1	Rm						

d = UInt(Rd); n = UInt(Rn); m = UInt(Rm);
 if BadReg(d) || BadReg(n) || BadReg(m) then UNPREDICTABLE;

Encoding A1 ARMv6*, ARMv7

QSUB8<c> <Rd>, <Rn>, <Rm>

31	30	29	28	27	26	25	24	23	22	21	20	19	18	17	16	15	14	13	12	11	10	9	8	7	6	5	4	3	2	1	0
cond	0	1	1	0	0	0	1	0	Rn	Rd	(1)	(1)	(1)	(1)	1	1	1	1	Rm												

d = UInt(Rd); n = UInt(Rn); m = UInt(Rm);
 if d == 15 || n == 15 || m == 15 then UNPREDICTABLE;

Assembler syntax

QSUB8<c><q> {<Rd>}, <Rn>, <Rm>

where:

<c><q> See *Standard assembler syntax fields* on page A8-7.

<Rd> The destination register.

<Rn> The first operand register.

<Rm> The second operand register.

Operation

```
if ConditionPassed() then
    EncodingSpecificOperations();
    diff1 = SInt(R[n]<7:0>) - SInt(R[m]<7:0>);
    diff2 = SInt(R[n]<15:8>) - SInt(R[m]<15:8>);
    diff3 = SInt(R[n]<23:16>) - SInt(R[m]<23:16>);
    diff4 = SInt(R[n]<31:24>) - SInt(R[m]<31:24>);
    R[d]<7:0> = SignedSat(diff1, 8);
    R[d]<15:8> = SignedSat(diff2, 8);
    R[d]<23:16> = SignedSat(diff3, 8);
    R[d]<31:24> = SignedSat(diff4, 8);
```

Exceptions

None.

A8.6.134 RBIT

Reverse Bits reverses the bit order in a 32-bit register.

Encoding T1 ARMv6T2, ARMv7

RBIT<c> <Rd>, <Rm>

15	14	13	12	11	10	9	8	7	6	5	4	3	2	1	0	15	14	13	12	11	10	9	8	7	6	5	4	3	2	1	0
1	1	1	1	1	0	1	0	1	0	0	1	Rm				1	1	1	1	Rd				1	0	1	0	Rm			

```

if !Consistent(Rm) then UNPREDICTABLE;
d = UInt(Rd); m = UInt(Rm);
if BadReg(d) || BadReg(m) then UNPREDICTABLE;
    
```

Encoding A1 ARMv6T2, ARMv7

RBIT<c> <Rd>, <Rm>

31	30	29	28	27	26	25	24	23	22	21	20	19	18	17	16	15	14	13	12	11	10	9	8	7	6	5	4	3	2	1	0
cond		0	1	1	0	1	1	1	1	(1)(1)(1)(1)				Rd				(1)(1)(1)(1)				0	0	1	1	Rm					

```

d = UInt(Rd); m = UInt(Rm);
if d == 15 || m == 15 then UNPREDICTABLE;
    
```

Assembler syntax

RBIT<c><q> <Rd>, <Rm>

where:

<c><q> See *Standard assembler syntax fields* on page A8-7.

<Rd> The destination register.

<Rm> The register that contains the operand. In encoding T1, its number must be encoded twice.

Operation

```
if ConditionPassed() then
    EncodingSpecificOperations();
    bits(32) result;
    for i = 0 to 31 do
        result<31-i> = R[m]<i>;
    R[d] = result;
```

Exceptions

None.

A8.6.135 REV

Byte-Reverse Word reverses the byte order in a 32-bit register.

Encoding T1 ARMv6*, ARMv7

REV<c> <Rd>, <Rm>

15	14	13	12	11	10	9	8	7	6	5	4	3	2	1	0
1	0	1	1	1	0	1	0	0	0	Rm				Rd	

d = UInt(Rd); m = UInt(Rm);

Encoding T2 ARMv6T2, ARMv7

REV<c>.W <Rd>, <Rm>

15	14	13	12	11	10	9	8	7	6	5	4	3	2	1	0	15	14	13	12	11	10	9	8	7	6	5	4	3	2	1	0
1	1	1	1	1	0	1	0	1	0	0	1	Rm				1	1	1	1	Rd				1	0	0	0	Rm			

if !Consistent(Rm) then UNPREDICTABLE;
d = UInt(Rd); m = UInt(Rm);
if BadReg(d) || BadReg(m) then UNPREDICTABLE;

Encoding A1 ARMv6*, ARMv7

REV<c> <Rd>, <Rm>

31	30	29	28	27	26	25	24	23	22	21	20	19	18	17	16	15	14	13	12	11	10	9	8	7	6	5	4	3	2	1	0
cond		0	1	1	0	1	0	0	1	1	(1)	(1)	(1)	(1)	Rd				(1)	(1)	(1)	(1)	0	0	1	1	Rm				

d = UInt(Rd); m = UInt(Rm);
if d == 15 || m == 15 then UNPREDICTABLE;

Assembler syntax

REV<c><q> <Rd>, <Rm>

where:

<c><q> See *Standard assembler syntax fields* on page A8-7.

<Rd> The destination register.

<Rm> The register that contains the operand. Its number must be encoded twice in encoding T2.

Operation

```
if ConditionPassed() then
    EncodingSpecificOperations();
    bits(32) result;
    result<31:24> = R[m]<7:0>;
    result<23:16> = R[m]<15:8>;
    result<15:8>  = R[m]<23:16>;
    result<7:0>  = R[m]<31:24>;
    R[d] = result;
```

Exceptions

None.

A8.6.136 REV16

Byte-Reverse Packed Halfword reverses the byte order in each 16-bit halfword of a 32-bit register.

Encoding T1 ARMv6*, ARMv7

REV16<c> <Rd>, <Rm>

15	14	13	12	11	10	9	8	7	6	5	4	3	2	1	0
1	0	1	1	1	0	1	0	0	1	Rm				Rd	

d = UInt(Rd); m = UInt(Rm);

Encoding T2 ARMv6T2, ARMv7

REV16<c>.W <Rd>, <Rm>

15	14	13	12	11	10	9	8	7	6	5	4	3	2	1	0	15	14	13	12	11	10	9	8	7	6	5	4	3	2	1	0
1	1	1	1	1	0	1	0	1	0	0	1	Rm				1	1	1	1	Rd				1	0	0	1	Rm			

if !Consistent(Rm) then UNPREDICTABLE;
d = UInt(Rd); m = UInt(Rm);
if BadReg(d) || BadReg(m) then UNPREDICTABLE;

Encoding A1 ARMv6*, ARMv7

REV16<c> <Rd>, <Rm>

31	30	29	28	27	26	25	24	23	22	21	20	19	18	17	16	15	14	13	12	11	10	9	8	7	6	5	4	3	2	1	0
cond		0	1	1	0	1	0	0	1	1	(1)	(1)	(1)	(1)	Rd				(1)	(1)	(1)	(1)	1	0	1	1	Rm				

d = UInt(Rd); m = UInt(Rm);
if d == 15 || m == 15 then UNPREDICTABLE;

Assembler syntax

REV16<c><q> <Rd>, <Rm>

where:

<c><q> See *Standard assembler syntax fields* on page A8-7.

<Rd> The destination register.

<Rm> The register that contains the operand. Its number must be encoded twice in encoding T2.

Operation

```
if ConditionPassed() then
    EncodingSpecificOperations();
    bits(32) result;
    result<31:24> = R[m]<23:16>;
    result<23:16> = R[m]<31:24>;
    result<15:8>  = R[m]<7:0>;
    result<7:0>  = R[m]<15:8>;
    R[d] = result;
```

Exceptions

None.

A8.6.137 REVSH

Byte-Reverse Signed Halfword reverses the byte order in the lower 16-bit halfword of a 32-bit register, and sign-extends the result to 32 bits.

Encoding T1 ARMv6*, ARMv7

REVSH<c> <Rd>, <Rm>

15	14	13	12	11	10	9	8	7	6	5	4	3	2	1	0
1	0	1	1	1	0	1	0	1	1	Rm				Rd	

d = UInt(Rd); m = UInt(Rm);

Encoding T2 ARMv6T2, ARMv7

REVSH<c>.W <Rd>, <Rm>

15	14	13	12	11	10	9	8	7	6	5	4	3	2	1	0	15	14	13	12	11	10	9	8	7	6	5	4	3	2	1	0
1	1	1	1	1	1	0	1	0	1	0	0	1	Rm					1	1	1	1	Rd	1	0	1	1	Rm				

if !Consistent(Rm) then UNPREDICTABLE;
d = UInt(Rd); m = UInt(Rm);
if BadReg(d) || BadReg(m) then UNPREDICTABLE;

Encoding A1 ARMv6*, ARMv7

REVSH<c> <Rd>, <Rm>

31	30	29	28	27	26	25	24	23	22	21	20	19	18	17	16	15	14	13	12	11	10	9	8	7	6	5	4	3	2	1	0
cond		0	1	1	0	1	1	1	1	(1)	(1)	(1)	(1)	Rd	(1)	(1)	(1)	(1)	1	0	1	1	Rm								

d = UInt(Rd); m = UInt(Rm);
if d == 15 || m == 15 then UNPREDICTABLE;

Assembler syntax

REVSH<c><q> <Rd>, <Rm>

where:

<c><q> See *Standard assembler syntax fields* on page A8-7.

<Rd> The destination register.

<Rm> The register that contains the operand. Its number must be encoded twice in encoding T2.

Operation

```
if ConditionPassed() then
    EncodingSpecificOperations();
    bits(32) result;
    result<31:8> = SignExtend(R[m]<7:0>, 24);
    result<7:0> = R[m]<15:8>;
    R[d] = result;
```

Exceptions

None.

A8.6.138 RFE

Return From Exception is a system instruction. For details see *RFE* on page B6-16.

A8.6.139 ROR (immediate)

Rotate Right (immediate) provides the value of the contents of a register rotated by a constant value. The bits that are rotated off the right end are inserted into the vacated bit positions on the left. It can optionally update the condition flags based on the result.

Encoding T1 ARMv6T2, ARMv7

ROR{S}<C> <Rd>, <Rm>, #<imm>

15	14	13	12	11	10	9	8	7	6	5	4	3	2	1	0	15	14	13	12	11	10	9	8	7	6	5	4	3	2	1	0
1	1	1	0	1	0	1	0	0	1	0	S	1	1	1	1	(0)	imm3			Rd			imm2		1	1	Rm				

```

if (imm3:imm2) == '00000' then SEE RRX;
d = UInt(Rd); m = UInt(Rm); setflags = (S == '1');
(-, shift_n) = DecodeImmShift('11', imm3:imm2);
if BadReg(d) || BadReg(m) then UNPREDICTABLE;
    
```

Encoding A1 ARMv4*, ARMv5T*, ARMv6*, ARMv7

ROR{S}<C> <Rd>, <Rm>, #<imm>

31	30	29	28	27	26	25	24	23	22	21	20	19	18	17	16	15	14	13	12	11	10	9	8	7	6	5	4	3	2	1	0
cond		0	0	0	1	1	0	1	S	(0)	(0)	(0)	(0)	Rd			imm5			1	1	0	Rm								

```

if imm5 == '00000' then SEE RRX;
d = UInt(Rd); m = UInt(Rm); setflags = (S == '1');
(-, shift_n) = DecodeImmShift('11', imm5);
    
```

Assembler syntax

ROR{S}<C><Q> {<Rd>}, <Rm>, #<imm>

where:

- S If S is present, the instruction updates the flags. Otherwise, the flags are not updated.
- <C><Q> See *Standard assembler syntax fields* on page A8-7.
- <Rd> The destination register. [↴](#)
- <Rm> The first operand register. [↴](#)
- <imm> The shift amount, in the range 1 to 31. See *Shifts applied to a register* on page A8-10.

Operation

```

if ConditionPassed() then
    EncodingSpecificOperations();
    (result, carry) = Shift_C(R[m], SRTYPE_ROR, shift_n, APSR.C);
    if d == 15 then // Can only occur for ARM encoding
        ALUWritePC(result); // setflags is always FALSE here
    else
        R[d] = result;
        if setflags then
            APSR.N = result<31>;
            APSR.Z = IsZeroBit(result);
            APSR.C = carry;
            // APSR.V unchanged

```

Exceptions

None.

A8.6.140 ROR (register)

Rotate Right (register) provides the value of the contents of a register rotated by a variable number of bits. The bits that are rotated off the right end are inserted into the vacated bit positions on the left. The variable number of bits is read from the bottom byte of a register. It can optionally update the condition flags based on the result.

Encoding T1 ARMv4T, ARMv5T*, ARMv6*, ARMv7

RORS <Rdn>, <Rm> Outside IT block.
 ROR<c> <Rdn>, <Rm> Inside IT block.

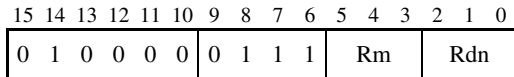

d = UInt(Rdn); n = UInt(Rdn); m = UInt(Rm); setflags = !InITBlock();

Encoding T2 ARMv6T2, ARMv7

ROR{S}<c>.W <Rd>, <Rn>, <Rm>

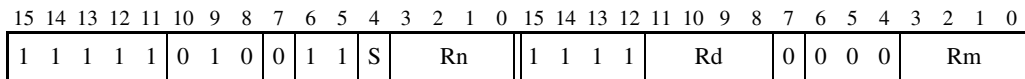

d = UInt(Rd); n = UInt(Rn); m = UInt(Rm); setflags = (S == '1');
 if BadReg(d) || BadReg(n) || BadReg(m) then UNPREDICTABLE;

Encoding A1 ARMv4*, ARMv5T*, ARMv6*, ARMv7

ROR{S}<c> <Rd>, <Rn>, <Rm>

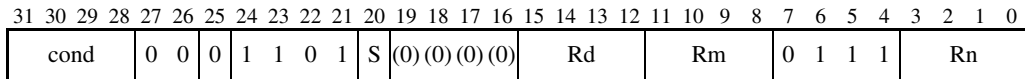

d = UInt(Rd); n = UInt(Rn); m = UInt(Rm); setflags = (S == '1');
 if d == 15 || n == 15 || m == 15 then UNPREDICTABLE;

Assembler syntax

```
ROR{S}<C><Q> {<Rd>}, <Rn>, <Rm>
```

where:

- S If S is present, the instruction updates the flags. Otherwise, the flags are not updated.
- <C><Q> See *Standard assembler syntax fields* on page A8-7.
- <Rd> The destination register.
- <Rn> The first operand register.
- <Rm> The register whose bottom byte contains the amount to rotate by.

Operation

```
if ConditionPassed() then
    EncodingSpecificOperations();
    shift_n = UInt(R[m]<7:0>);
    (result, carry) = Shift_C(R[n], SRTYPE_ROR, shift_n, APSR.C);
    R[d] = result;
    if setflags then
        APSR.N = result<31>;
        APSR.Z = IsZeroBit(result);
        APSR.C = carry;
        // APSR.V unchanged
```

Exceptions

None.

A8.6.141 RRX

Rotate Right with Extend provides the value of the contents of a register shifted right by one place, with the carry flag shifted into bit [31].

RRX can optionally update the condition flags based on the result. In that case, bit [0] is shifted into the carry flag.

Encoding T1 ARMv6T2, ARMv7

RRX{S}<C> <Rd>, <Rm>

15	14	13	12	11	10	9	8	7	6	5	4	3	2	1	0	15	14	13	12	11	10	9	8	7	6	5	4	3	2	1	0
1	1	1	0	1	0	1	0	0	1	0	S	1	1	1	1	(0)	0	0	0	Rd				0	0	1	1	Rm			

d = UInt(Rd); m = UInt(Rm); setflags = (S == '1');
 if BadReg(d) || BadReg(m) then UNPREDICTABLE;

Encoding A1 ARMv4*, ARMv5T*, ARMv6*, ARMv7

RRX{S}<C> <Rd>, <Rm>

31	30	29	28	27	26	25	24	23	22	21	20	19	18	17	16	15	14	13	12	11	10	9	8	7	6	5	4	3	2	1	0
cond			0	0	0	1	1	0	1	S	(0)	(0)	(0)	(0)	Rd				0	0	0	0	0	1	1	0	Rm				

d = UInt(Rd); m = UInt(Rm); setflags = (S == '1');

Assembler syntax

```
RRX{S}<C><Q> {<Rd>}, <Rm>
```

where:

S If S is present, the instruction updates the flags. Otherwise, the flags are not updated.

<C><Q> See *Standard assembler syntax fields* on page A8-7.

<Rd> The destination register [1](#).

<Rm> The register that contains the operand [1](#).

Operation

```
if ConditionPassed() then
    EncodingSpecificOperations();
    (result, carry) = Shift_C(R[m], SRTYPE_RRX, 1, APSR.C);
    if d == 15 then // Can only occur for ARM encoding
        ALUWritePC(result); // setflags is always FALSE here
    else
        R[d] = result;
        if setflags then
            APSR.N = result<31>;
            APSR.Z = IsZeroBit(result);
            APSR.C = carry;
            // APSR.V unchanged
```

Exceptions

None.

A8.6.142 RSB (immediate)

Reverse Subtract (immediate) subtracts a register value from an immediate value, and writes the result to the destination register. It can optionally update the condition flags based on the result.

Encoding T1 ARMv4T, ARMv5T*, ARMv6*, ARMv7

RSBS <Rd>, <Rn>, #0 Outside IT block.

RSB<c> <Rd>, <Rn>, #0 Inside IT block.

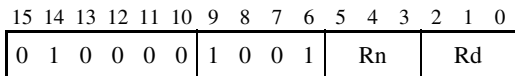

d = UInt(Rd); n = UInt(Rn); setflags = !InITBlock(); imm32 = Zeros(32); // immediate = #0

Encoding T2 ARMv6T2, ARMv7

RSB{S}<c>.W <Rd>, <Rn>, #<const>

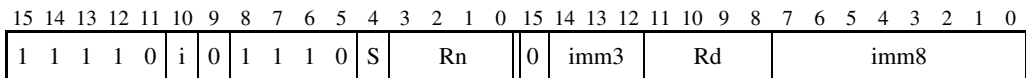

d = UInt(Rd); n = UInt(Rn); setflags = (S == '1'); imm32 = ThumbExpandImm(i:imm3:imm8);
 if BadReg(d) || BadReg(n) then UNPREDICTABLE;

Encoding A1 ARMv4*, ARMv5T*, ARMv6*, ARMv7

RSB{S}<c> <Rd>, <Rn>, #<const>

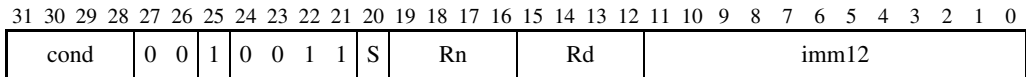

if Rd == '1111' && S == '1' then SEE SUBS PC, LR and related instructions;
 d = UInt(Rd); n = UInt(Rn); setflags = (S == '1'); imm32 = ARMEExpandImm(imm12);

Assembler syntax

RSB{S}<c><q> {<Rd>}, <Rn>, #<const>

where:

- S If S is present, the instruction updates the flags. Otherwise, the flags are not updated.
- <c><q> See *Standard assembler syntax fields* on page A8-7.
- <Rd> The destination register.
- <Rn> The first operand register.
- <const> The immediate value to be added to the value obtained from <Rn>. The only permitted value for encoding T1 is 0. See *Modified immediate constants in Thumb instructions* on page A6-17 or *Modified immediate constants in ARM instructions* on page A5-9 for the range of values for encoding T2 or A1.

The pre-UAL syntax RSB<c>S is equivalent to RSBS<c>.

Operation

```

if ConditionPassed() then
    EncodingSpecificOperations();
    (result, carry, overflow) = AddWithCarry(NOT(R[n]), imm32, '1');
    if d == 15 then // Can only occur for ARM encoding
        ALUWritePC(result); // setflags is always FALSE here
    else
        R[d] = result;
        if setflags then
            APSR.N = result<31>;
            APSR.Z = IsZeroBit(result);
            APSR.C = carry;
            APSR.V = overflow;

```

Exceptions

None.

A8.6.143 RSB (register)

Reverse Subtract (register) subtracts a register value from an optionally-shifted register value, and writes the result to the destination register. It can optionally update the condition flags based on the result.

Encoding T1 ARMv6T2, ARMv7

RSB{S}<C> <Rd>, <Rn>, <Rm>{, <shift>}

15	14	13	12	11	10	9	8	7	6	5	4	3	2	1	0	15	14	13	12	11	10	9	8	7	6	5	4	3	2	1	0
1	1	1	0	1	0	1	1	1	0	S	Rn				(0)	imm3			Rd			imm2		type		Rm					

```
d = UInt(Rd); n = UInt(Rn); m = UInt(Rm); setflags = (S == '1');
(shift_t, shift_n) = DecodeImmShift(type, imm3:imm2);
if BadReg(d) || BadReg(n) || BadReg(m) then UNPREDICTABLE;
```

Encoding A1 ARMv4*, ARMv5T*, ARMv6*, ARMv7

RSB{S}<C> <Rd>, <Rn>, <Rm>{, <shift>}

31	30	29	28	27	26	25	24	23	22	21	20	19	18	17	16	15	14	13	12	11	10	9	8	7	6	5	4	3	2	1	0
cond		0	0	0	0	0	1	1	S	Rn				Rd				imm5			type		0	Rm							

```
if Rd == '1111' && S == '1' then SEE SUBS PC, LR and related instructions;
d = UInt(Rd); n = UInt(Rn); m = UInt(Rm); setflags = (S == '1');
(shift_t, shift_n) = DecodeImmShift(type, imm5);
```

Assembler syntax

RSB{S}<C><Q> {<Rd>}, <Rn>, <Rm> {,<shift>}

where:

S	If S is present, the instruction updates the flags. Otherwise, the flags are not updated.
<C><Q>	See <i>Standard assembler syntax fields</i> on page A8-7.
<Rd>	The destination register. ↴
<Rn>	The first operand register. ↴
<Rm>	The register that is optionally shifted and used as the second operand. ↴
<shift>	The shift to apply to the value read from <Rm>. If omitted, no shift is applied. <i>Shifts applied to a register</i> on page A8-10 describes the shifts and how they are encoded.

The pre-UAL syntax RSB<C>S is equivalent to RSBS<C>.

Operation

```

if ConditionPassed() then
    EncodingSpecificOperations();
    shifted = Shift(R[m], shift_t, shift_n, APSR.C);
    (result, carry, overflow) = AddWithCarry(NOT(R[n]), shifted, '1');
    if d == 15 then // Can only occur for ARM encoding
        ALUWritePC(result); // setflags is always FALSE here
    else
        R[d] = result;
        if setflags then
            APSR.N = result<31>;
            APSR.Z = IsZeroBit(result);
            APSR.C = carry;
            APSR.V = overflow;

```

Exceptions

None.

A8.6.144 RSB (register-shifted register)

Reverse Subtract (register-shifted register) subtracts a register value from a register-shifted register value, and writes the result to the destination register. It can optionally update the condition flags based on the result.

Encoding A1 ARMv4*, ARMv5T*, ARMv6*, ARMv7

RSB{S}<C> <Rd>, <Rn>, <Rm>, <type> <Rs>

31	30	29	28	27	26	25	24	23	22	21	20	19	18	17	16	15	14	13	12	11	10	9	8	7	6	5	4	3	2	1	0
cond				0	0	0	0	0	1	1	S	Rn				Rd				Rs				0	type		1	Rm			

```
d = UInt(Rd);  n = UInt(Rn);  m = UInt(Rm);  s = UInt(Rs);
setflags = (S == '1');  shift_t = DecodeRegShift(type);
if d == 15 || n == 15 || m == 15 || s == 15 then UNPREDICTABLE;
```

Assembler syntax

RSB{S}<C><Q> {<Rd>}, <Rn>, <Rm>, <type> <Rs>

where:

S If S is present, the instruction updates the flags. Otherwise, the flags are not updated.

<C><Q> See *Standard assembler syntax fields* on page A8-7.

<Rd> The destination register.

<Rn> The first operand register.

<Rm> The register that is shifted and used as the second operand.

<type> The type of shift to apply to the value read from <Rm>. It must be one of:

ASR Arithmetic shift right, encoded as type = 0b10

LSL Logical shift left, encoded as type = 0b00

LSR Logical shift right, encoded as type = 0b01

ROR Rotate right, encoded as type = 0b11.

<Rs> The register whose bottom byte contains the amount to shift by.

The pre-UAL syntax RSB<C>S is equivalent to RSBS<C>.

Operation

```
if ConditionPassed() then
    EncodingSpecificOperations();
    shift_n = UInt(R[s]<7:0>);
    shifted = Shift(R[m], shift_t, shift_n, APSR.C);
    (result, carry, overflow) = AddWithCarry(NOT(R[n]), shifted, '1');
    R[d] = result;
    if setflags then
        APSR.N = result<31>;
        APSR.Z = IsZeroBit(result);
        APSR.C = carry;
        APSR.V = overflow;
```

Exceptions

None.

A8.6.145 RSC (immediate)

Reverse Subtract with Carry (immediate) subtracts a register value and the value of NOT (Carry flag) from an immediate value, and writes the result to the destination register. It can optionally update the condition flags based on the result.

Encoding A1 ARMv4*, ARMv5T*, ARMv6*, ARMv7

RSC{S}<c> <Rd>, <Rn>, #<const>

31	30	29	28	27	26	25	24	23	22	21	20	19	18	17	16	15	14	13	12	11	10	9	8	7	6	5	4	3	2	1	0
cond				0	0	1	0	1	1	1	S	Rn				Rd				imm12											

if Rd == '1111' && S == '1' then SEE SUBS PC, LR and related instructions;
d = UInt(Rd); n = UInt(Rn); setflags = (S == '1'); imm32 = ARMEExpandImm(imm12);

Assembler syntax

RSC{S}<c><q> {<Rd>}, <Rn>, #<const>

where:

- S If S is present, the instruction updates the flags. Otherwise, the flags are not updated.
- <c><q> See *Standard assembler syntax fields* on page A8-7.
- <Rd> The destination register. [↴](#)
- <Rn> The first operand register. [↴](#)
- <const> The immediate value that the value obtained from <Rn> is to be subtracted from. See *Modified immediate constants in ARM instructions* on page A5-9 for the range of values.

The pre-UAL syntax RSC<c>S is equivalent to RSCS<c>.

Operation

```

if ConditionPassed() then
    EncodingSpecificOperations();
    (result, carry, overflow) = AddWithCarry(NOT(R[n]), imm32, APSR.C);
    if d == 15 then
        ALUWritePC(result); // setflags is always FALSE here
    else
        R[d] = result;
        if setflags then
            APSR.N = result<31>;
            APSR.Z = IsZeroBit(result);
            APSR.C = carry;
            APSR.V = overflow;

```

Exceptions

None.

A8.6.146 RSC (register)

Reverse Subtract with Carry (register) subtracts a register value and the value of NOT (Carry flag) from an optionally-shifted register value, and writes the result to the destination register. It can optionally update the condition flags based on the result.

Encoding A1 ARMv4*, ARMv5T*, ARMv6*, ARMv7

RSC{S}<c> <Rd>, <Rn>, <Rm>{, <shift>}

31	30	29	28	27	26	25	24	23	22	21	20	19	18	17	16	15	14	13	12	11	10	9	8	7	6	5	4	3	2	1	0
cond			0	0	0	0	1	1	1	S	Rn				Rd				imm5			type	0	Rm							

```
if Rd == '1111' && S == '1' then SEE SUBS PC, LR and related instructions;
d = UInt(Rd); n = UInt(Rn); m = UInt(Rm); setflags = (S == '1');
(shift_t, shift_n) = DecodeImmShift(type, imm5);
```

Assembler syntax

RSC{S}<c><q> {<Rd>}, <Rn>, <Rm> {,<shift>}

where:

S	If S is present, the instruction updates the flags. Otherwise, the flags are not updated.
<c><q>	See <i>Standard assembler syntax fields</i> on page A8-7.
<Rd>	The destination register. ↴
<Rn>	The first operand register. ↴
<Rm>	The register that is optionally shifted and used as the second operand. ↴
<shift>	The shift to apply to the value read from <Rm>. If omitted, no shift is applied. <i>Shifts applied to a register</i> on page A8-10 describes the shifts and how they are encoded.

The pre-UAL syntax RSC<c>S is equivalent to RSCS<c>.

Operation

```

if ConditionPassed() then
    EncodingSpecificOperations();
    shifted = Shift(R[m], shift_t, shift_n, APSR.C);
    (result, carry, overflow) = AddWithCarry(NOT(R[n]), shifted, APSR.C);
    if d == 15 then
        ALUWritePC(result); // setflags is always FALSE here
    else
        R[d] = result;
        if setflags then
            APSR.N = result<31>;
            APSR.Z = IsZeroBit(result);
            APSR.C = carry;
            APSR.V = overflow;

```

Exceptions

None.

A8.6.147 RSC (register-shifted register)

Reverse Subtract (register-shifted register) subtracts a register value and the value of NOT (Carry flag) from a register-shifted register value, and writes the result to the destination register. It can optionally update the condition flags based on the result.

Encoding A1 ARMv4*, ARMv5T*, ARMv6*, ARMv7

RSC{S}<C> <Rd>, <Rn>, <Rm>, <type> <Rs>

31	30	29	28	27	26	25	24	23	22	21	20	19	18	17	16	15	14	13	12	11	10	9	8	7	6	5	4	3	2	1	0
cond				0	0	0	0	1	1	1	S	Rn				Rd				Rs				0	type		1	Rm			

```
d = UInt(Rd); n = UInt(Rn); m = UInt(Rm); s = UInt(Rs);
setflags = (S == '1'); shift_t = DecodeRegShift(type);
if d == 15 || n == 15 || m == 15 || s == 15 then UNPREDICTABLE;
```

Assembler syntax

RSC{S}<C><Q> {<Rd>}, <Rn>, <Rm>, <type> <Rs>

where:

S If S is present, the instruction updates the flags. Otherwise, the flags are not updated.

<C><Q> See *Standard assembler syntax fields* on page A8-7.

<Rd> The destination register.

<Rn> The first operand register.

<Rm> The register that is shifted and used as the second operand.

<type> The type of shift to apply to the value read from <Rm>. It must be one of:

ASR Arithmetic shift right, encoded as type = 0b10

LSL Logical shift left, encoded as type = 0b00

LSR Logical shift right, encoded as type = 0b01

ROR Rotate right, encoded as type = 0b11.

<Rs> The register whose bottom byte contains the amount to shift by.

The pre-UAL syntax RSC<C>S is equivalent to RSCS<C>.

Operation

```

if ConditionPassed() then
    EncodingSpecificOperations();
    shift_n = UInt(R[s]<7:0>);
    shifted = Shift(R[m], shift_t, shift_n, APSR.C);
    (result, carry, overflow) = AddWithCarry(NOT(R[n]), shifted, APSR.C);
    R[d] = result;
    if setflags then
        APSR.N = result<31>;
        APSR.Z = IsZeroBit(result);
        APSR.C = carry;
        APSR.V = overflow;

```

Exceptions

None.

A8.6.148 SADD16

Signed Add 16 performs two 16-bit signed integer additions, and writes the results to the destination register. It sets the APSR.GE bits according to the results of the additions.

Encoding T1 ARMv6T2, ARMv7

SADD16<c> <Rd>, <Rn>, <Rm>

15	14	13	12	11	10	9	8	7	6	5	4	3	2	1	0	15	14	13	12	11	10	9	8	7	6	5	4	3	2	1	0
1	1	1	1	1	0	1	0	1	0	0	1	Rn				1	1	1	1	Rd				0	0	0	0	Rm			

d = UInt(Rd); n = UInt(Rn); m = UInt(Rm);
 if BadReg(d) || BadReg(n) || BadReg(m) then UNPREDICTABLE;

Encoding A1 ARMv6*, ARMv7

SADD16<c> <Rd>, <Rn>, <Rm>

31	30	29	28	27	26	25	24	23	22	21	20	19	18	17	16	15	14	13	12	11	10	9	8	7	6	5	4	3	2	1	0	
cond		0	1	1	0	0	0	0	1	Rn				Rd				(1)	(1)	(1)	(1)	0				0	0	1	Rm			

d = UInt(Rd); n = UInt(Rn); m = UInt(Rm);
 if d == 15 || n == 15 || m == 15 then UNPREDICTABLE;

Assembler syntax

SADD16<c><q> {<Rd>}, <Rn>, <Rm>

where:

<c><q> See *Standard assembler syntax fields* on page A8-7.

<Rd> The destination register.

<Rn> The first operand register.

<Rm> The second operand register.

Operation

```
if ConditionPassed() then
    EncodingSpecificOperations();
    sum1 = SInt(R[n]<15:0>) + SInt(R[m]<15:0>);
    sum2 = SInt(R[n]<31:16>) + SInt(R[m]<31:16>);
    R[d]<15:0> = sum1<15:0>;
    R[d]<31:16> = sum2<15:0>;
    APSR.GE<1:0> = if sum1 >= 0 then '11' else '00';
    APSR.GE<3:2> = if sum2 >= 0 then '11' else '00';
```

Exceptions

None.

A8.6.149 SADD8

Signed Add 8 performs four 8-bit signed integer additions, and writes the results to the destination register. It sets the APSR.GE bits according to the results of the additions.

Encoding T1 ARMv6T2, ARMv7

SADD8<c> <Rd>, <Rn>, <Rm>

15	14	13	12	11	10	9	8	7	6	5	4	3	2	1	0	15	14	13	12	11	10	9	8	7	6	5	4	3	2	1	0
1	1	1	1	1	0	1	0	1	0	0	0	Rn				1	1	1	1	Rd	0	0	0	0	Rm						

d = UInt(Rd); n = UInt(Rn); m = UInt(Rm);
 if BadReg(d) || BadReg(n) || BadReg(m) then UNPREDICTABLE;

Encoding A1 ARMv6*, ARMv7

SADD8<c> <Rd>, <Rn>, <Rm>

31	30	29	28	27	26	25	24	23	22	21	20	19	18	17	16	15	14	13	12	11	10	9	8	7	6	5	4	3	2	1	0																	
cond																																Rn	Rd	(1)(1)(1)(1)	1	0	0	1	Rm									

d = UInt(Rd); n = UInt(Rn); m = UInt(Rm);
 if d == 15 || n == 15 || m == 15 then UNPREDICTABLE;

Assembler syntax

SADD8<c><q> {<Rd>}, <Rn>, <Rm>

where:

<c><q> See *Standard assembler syntax fields* on page A8-7.

<Rd> The destination register.

<Rn> The first operand register.

<Rm> The second operand register.

Operation

```

if ConditionPassed() then
    EncodingSpecificOperations();
    sum1 = SInt(R[n]<7:0>) + SInt(R[m]<7:0>);
    sum2 = SInt(R[n]<15:8>) + SInt(R[m]<15:8>);
    sum3 = SInt(R[n]<23:16>) + SInt(R[m]<23:16>);
    sum4 = SInt(R[n]<31:24>) + SInt(R[m]<31:24>);
    R[d]<7:0> = sum1<7:0>;
    R[d]<15:8> = sum2<7:0>;
    R[d]<23:16> = sum3<7:0>;
    R[d]<31:24> = sum4<7:0>;
    APSR.GE<0> = if sum1 >= 0 then '1' else '0';
    APSR.GE<1> = if sum2 >= 0 then '1' else '0';
    APSR.GE<2> = if sum3 >= 0 then '1' else '0';
    APSR.GE<3> = if sum4 >= 0 then '1' else '0';

```

Exceptions

None.

A8.6.150 SASX

Signed Add and Subtract with Exchange exchanges the two halfwords of the second operand, performs one 16-bit integer addition and one 16-bit subtraction, and writes the results to the destination register. It sets the APSR.GE bits according to the results.

Encoding T1 ARMv6T2, ARMv7

SASX<c> <Rd>, <Rn>, <Rm>

15	14	13	12	11	10	9	8	7	6	5	4	3	2	1	0	15	14	13	12	11	10	9	8	7	6	5	4	3	2	1	0
1	1	1	1	1	0	1	0	1	0	1	0	Rn				1	1	1	1	Rd				0	0	0	0	Rm			

d = UInt(Rd); n = UInt(Rn); m = UInt(Rm);
 if BadReg(d) || BadReg(n) || BadReg(m) then UNPREDICTABLE;

Encoding A1 ARMv6*, ARMv7

SASX<c> <Rd>, <Rn>, <Rm>

31	30	29	28	27	26	25	24	23	22	21	20	19	18	17	16	15	14	13	12	11	10	9	8	7	6	5	4	3	2	1	0	
cond		0	1	1	0	0	0	0	0	1	Rn				Rd				(1)	(1)	(1)	(1)	0	0	1	1	Rm					

d = UInt(Rd); n = UInt(Rn); m = UInt(Rm);
 if d == 15 || n == 15 || m == 15 then UNPREDICTABLE;

Assembler syntax

SASX<c><q> {<Rd>}, <Rn>, <Rm>

where:

<c><q> See *Standard assembler syntax fields* on page A8-7.

<Rd> The destination register.

<Rn> The first operand register.

<Rm> The second operand register.

The pre-UAL syntax SADDSUBX<c> is equivalent to SASX<c>.

Operation

```
if ConditionPassed() then
    EncodingSpecificOperations();
    diff = SInt(R[n]<15:0>) - SInt(R[m]<31:16>);
    sum = SInt(R[n]<31:16>) + SInt(R[m]<15:0>);
    R[d]<15:0> = diff<15:0>;
    R[d]<31:16> = sum<15:0>;
    APSR.GE<1:0> = if diff >= 0 then '11' else '00';
    APSR.GE<3:2> = if sum >= 0 then '11' else '00';
```

Exceptions

None.

A8.6.151 SBC (immediate)

Subtract with Carry (immediate) subtracts an immediate value and the value of NOT (Carry flag) from a register value, and writes the result to the destination register. It can optionally update the condition flags based on the result.

Encoding T1 ARMv6T2, ARMv7

SBC{S}<c> <Rd>, <Rn>, #<const>

15	14	13	12	11	10	9	8	7	6	5	4	3	2	1	0	15	14	13	12	11	10	9	8	7	6	5	4	3	2	1	0
1	1	1	1	0	i	0	1	0	1	1	S	Rn				0	imm3			Rd				imm8							

d = UInt(Rd); n = UInt(Rn); setflags = (S == '1'); imm32 = ThumbExpandImm(i:imm3:imm8);
 if BadReg(d) || BadReg(n) then UNPREDICTABLE;

Encoding A1 ARMv4*, ARMv5T*, ARMv6*, ARMv7

SBC{S}<c> <Rd>, <Rn>, #<const>

31	30	29	28	27	26	25	24	23	22	21	20	19	18	17	16	15	14	13	12	11	10	9	8	7	6	5	4	3	2	1	0
cond			0	0	1	0	1	1	0	S	Rn				Rd				imm12												

if Rd == '1111' && S == '1' then SEE SUBS PC, LR and related instructions;
 d = UInt(Rd); n = UInt(Rn); setflags = (S == '1'); imm32 = ARMEExpandImm(imm12);

Assembler syntax

SBC{S}<C><Q> {<Rd>}, <Rn>, #<const>

where:

- S If S is present, the instruction updates the flags. Otherwise, the flags are not updated.
- <C><Q> See *Standard assembler syntax fields* on page A8-7.
- <Rd> The destination register.
- <Rn> The first operand register.
- <const> The immediate value to be subtracted from the value obtained from <Rn>. See *Modified immediate constants in Thumb instructions* on page A6-17 or *Modified immediate constants in ARM instructions* on page A5-9 for the range of values.

The pre-UAL syntax SBC<C>S is equivalent to SBCS<C>.

Operation

```

if ConditionPassed() then
    EncodingSpecificOperations();
    (result, carry, overflow) = AddWithCarry(R[n], NOT(imm32), APSR.C);
    if d == 15 then // Can only occur for ARM encoding
        ALUWritePC(result); // setflags is always FALSE here
    else
        R[d] = result;
        if setflags then
            APSR.N = result<31>;
            APSR.Z = IsZeroBit(result);
            APSR.C = carry;
            APSR.V = overflow;

```

Exceptions

None.

A8.6.152 SBC (register)

Subtract with Carry (register) subtracts an optionally-shifted register value and the value of NOT (Carry flag) from a register value, and writes the result to the destination register. It can optionally update the condition flags based on the result.

Encoding T1 ARMv4T, ARMv5T*, ARMv6*, ARMv7

SBCS <Rdn>, <Rm>

Outside IT block.

SBC<c> <Rdn>, <Rm>

Inside IT block.

15	14	13	12	11	10	9	8	7	6	5	4	3	2	1	0
0	1	0	0	0	0	0	1	1	0	Rm				Rdn	

```
d = UInt(Rdn); n = UInt(Rdn); m = UInt(Rm); setflags = !InITBlock();
(shift_t, shift_n) = (SRTYPE_LSL, 0);
```

Encoding T2 ARMv6T2, ARMv7

SBC{S}<c>.W <Rd>, <Rn>, <Rm>{, <shift>}

15	14	13	12	11	10	9	8	7	6	5	4	3	2	1	0	15	14	13	12	11	10	9	8	7	6	5	4	3	2	1	0
1	1	1	0	1	0	1	1	0	1	1	S	Rn	(0)	imm3	Rd	imm2	type	Rm													

```
d = UInt(Rd); n = UInt(Rn); m = UInt(Rm); setflags = (S == '1');
(shift_t, shift_n) = DecodeImmShift(type, imm3:imm2);
if BadReg(d) || BadReg(n) || BadReg(m) then UNPREDICTABLE;
```

Encoding A1 ARMv4*, ARMv5T*, ARMv6*, ARMv7

SBC{S}<c> <Rd>, <Rn>, <Rm>{, <shift>}

31	30	29	28	27	26	25	24	23	22	21	20	19	18	17	16	15	14	13	12	11	10	9	8	7	6	5	4	3	2	1	0		
cond	0	0	0	0	1	1	0	S	Rn		Rd																						

```
if Rd == '1111' && S == '1' then SEE SUBS PC, LR and related instructions;
d = UInt(Rd); n = UInt(Rn); m = UInt(Rm); setflags = (S == '1');
(shift_t, shift_n) = DecodeImmShift(type, imm5);
```

Assembler syntax

SBC{S}<C><Q> {<Rd>}, <Rn>, <Rm> {,<shift>}

where:

S	If S is present, the instruction updates the flags. Otherwise, the flags are not updated.
<C><Q>	See <i>Standard assembler syntax fields</i> on page A8-7.
<Rd>	The destination register. ↴
<Rn>	The first operand register. ↴
<Rm>	The register that is optionally shifted and used as the second operand. ↴
<shift>	The shift to apply to the value read from <Rm>. If present, encoding T1 is not permitted. If absent, no shift is applied and all encodings are permitted. <i>Shifts applied to a register</i> on page A8-10 describes the shifts and how they are encoded.

The pre-UAL syntax SBC<C>S is equivalent to SBCS<C>.

Operation

```

if ConditionPassed() then
    EncodingSpecificOperations();
    shifted = Shift(R[m], shift_t, shift_n, APSR.C);
    (result, carry, overflow) = AddWithCarry(R[n], NOT(shifted), APSR.C);
    if d == 15 then // Can only occur for ARM encoding
        ALUWritePC(result); // setflags is always FALSE here
    else
        R[d] = result;
        if setflags then
            APSR.N = result<31>;
            APSR.Z = IsZeroBit(result);
            APSR.C = carry;
            APSR.V = overflow;

```

Exceptions

None.

A8.6.153 SBC (register-shifted register)

Subtract with Carry (register-shifted register) subtracts a register-shifted register value and the value of NOT (Carry flag) from a register value, and writes the result to the destination register. It can optionally update the condition flags based on the result.

Encoding A1 ARMv4*, ARMv5T*, ARMv6*, ARMv7

SBC{S}<c> <Rd>, <Rn>, <Rm>, <type> <Rs>

31	30	29	28	27	26	25	24	23	22	21	20	19	18	17	16	15	14	13	12	11	10	9	8	7	6	5	4	3	2	1	0
cond				0	0	0	0	1	1	0	S	Rn				Rd				Rs				0	type		1	Rm			

```
d = UInt(Rd); n = UInt(Rn); m = UInt(Rm); s = UInt(Rs);
setflags = (S == '1'); shift_t = DecodeRegShift(type);
if d == 15 || n == 15 || m == 15 || s == 15 then UNPREDICTABLE;
```

Assembler syntax

SBC{S}<C><Q> {<Rd>}, <Rn>, <Rm>, <type> <Rs>

where:

S	If S is present, the instruction updates the flags. Otherwise, the flags are not updated.								
<C><Q>	See <i>Standard assembler syntax fields</i> on page A8-7.								
<Rd>	The destination register.								
<Rn>	The first operand register.								
<Rm>	The register that is shifted and used as the second operand.								
<type>	The type of shift to apply to the value read from <Rm>. It must be one of: <table> <tr> <td>ASR</td> <td>Arithmetic shift right, encoded as type = 0b10</td> </tr> <tr> <td>LSL</td> <td>Logical shift left, encoded as type = 0b00</td> </tr> <tr> <td>LSR</td> <td>Logical shift right, encoded as type = 0b01</td> </tr> <tr> <td>ROR</td> <td>Rotate right, encoded as type = 0b11.</td> </tr> </table>	ASR	Arithmetic shift right, encoded as type = 0b10	LSL	Logical shift left, encoded as type = 0b00	LSR	Logical shift right, encoded as type = 0b01	ROR	Rotate right, encoded as type = 0b11.
ASR	Arithmetic shift right, encoded as type = 0b10								
LSL	Logical shift left, encoded as type = 0b00								
LSR	Logical shift right, encoded as type = 0b01								
ROR	Rotate right, encoded as type = 0b11.								
<Rs>	The register whose bottom byte contains the amount to shift by.								

The pre-UAL syntax SBC<C>S is equivalent to SBCS<C>.

Operation

```

if ConditionPassed() then
    EncodingSpecificOperations();
    shift_n = UInt(R[s]<7:0>);
    shifted = Shift(R[m], shift_t, shift_n, APSR.C);
    (result, carry, overflow) = AddWithCarry(R[n], NOT(shifted), APSR.C);
    R[d] = result;
    if setflags then
        APSR.N = result<31>;
        APSR.Z = IsZeroBit(result);
        APSR.C = carry;
        APSR.V = overflow;
  
```

Exceptions

None.

A8.6.154 SBFX

Signed Bit Field Extract extracts any number of adjacent bits at any position from a register, sign-extends them to 32 bits, and writes the result to the destination register.

Encoding T1 ARMv6T2, ARMv7

SBFX<c> <Rd>, <Rn>, #<lsb>, #<width>

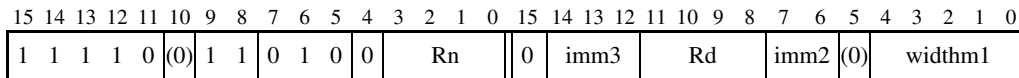

```
d = UInt(Rd); n = UInt(Rn);
lsbit = UInt(imm3:imm2); widthminus1 = UInt(widthm1);
if BadReg(d) || BadReg(n) then UNPREDICTABLE;
```

Encoding A1 ARMv6T2, ARMv7

SBFX<c> <Rd>, <Rn>, #<lsb>, #<width>

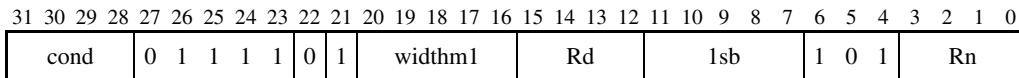

```
d = UInt(Rd); n = UInt(Rn);
lsbit = UInt(1sb); widthminus1 = UInt(widthm1);
if d == 15 || n == 15 then UNPREDICTABLE;
```

Assembler syntax

SBFX<c><q> <Rd>, <Rn>, #<lsb>, #<width>

where:

<c><q>	See <i>Standard assembler syntax fields</i> on page A8-7.
<Rd>	The destination register.
<Rn>	The first operand register.
<lsb>	is the bit number of the least significant bit in the bitfield, in the range 0-31. This determines the required value of <code>lsbit</code> .
<width>	is the width of the bitfield, in the range 1 to 32- <code><lsb></code> . The required value of <code>widthminus1</code> is <code><width>-1</code> .

Operation

```

if ConditionPassed() then
    EncodingSpecificOperations();
    msbit = lsbit + widthminus1;
    if msbit <= 31 then
        R[d] = SignExtend(R[n]<msbit:lsbit>, 32);
    else
        UNPREDICTABLE;

```

Exceptions

None.

A8.6.155 SDIV

Signed Divide divides a 32-bit signed integer register value by a 32-bit signed integer register value, and writes the result to the destination register. The condition code flags are not affected.

Encoding T1 ARMv7-R

SDIV<c> <Rd>, <Rn>, <Rm>

15	14	13	12	11	10	9	8	7	6	5	4	3	2	1	0	15	14	13	12	11	10	9	8	7	6	5	4	3	2	1	0
1	1	1	1	1	0	1	1	1	0	0	1	Rn				(1) (1) (1) (1)				Rd				1 1 1 1				Rm			

d = UInt(Rd); n = UInt(Rn); m = UInt(Rm);
 if BadReg(d) || BadReg(n) || BadReg(m) then UNPREDICTABLE;

Assembler syntax

SDIV<c><q> {<Rd>}, <Rn>, <Rm>

where:

<c><q> See *Standard assembler syntax fields* on page A8-7.

<Rd> The destination register.

<Rn> The register that contains the dividend.

<Rm> The register that contains the divisor.

Operation

```

if ConditionPassed() then
    EncodingSpecificOperations();
    if SInt(R[m]) == 0 then
        if IntegerZeroDivideTrappingEnabled() then
            GenerateIntegerZeroDivide();
        else
            result = 0;
    else
        result = RoundTowardsZero(SInt(R[n]) / SInt(R[m]));
    R[d] = result<31:0>;

```

Exceptions

Undefined Instruction.

Overflow

If the signed integer division $0x80000000 / 0xFFFFFFFF$ is performed, the pseudocode produces the intermediate integer result $+2^{31}$, that overflows the 32-bit signed integer range. No indication of this overflow case is produced, and the 32-bit result written to R[d] must be the bottom 32 bits of the binary representation of $+2^{31}$. So the result of the division is $0x80000000$.

A8.6.156 SEL

Select Bytes selects each byte of its result from either its first operand or its second operand, according to the values of the GE flags.

Encoding T1 ARMv6T2, ARMv7

SEL<c> <Rd>, <Rn>, <Rm>

15	14	13	12	11	10	9	8	7	6	5	4	3	2	1	0	15	14	13	12	11	10	9	8	7	6	5	4	3	2	1	0
1	1	1	1	1	0	1	0	1	0	1	0	Rn			1	1	1	1	Rd			1	0	0	0	Rm					

d = UInt(Rd); n = UInt(Rn); m = UInt(Rm);
 if BadReg(d) || BadReg(n) || BadReg(m) then UNPREDICTABLE;

Encoding A1 ARMv6*, ARMv7

SEL<c> <Rd>, <Rn>, <Rm>

31	30	29	28	27	26	25	24	23	22	21	20	19	18	17	16	15	14	13	12	11	10	9	8	7	6	5	4	3	2	1	0
cond		0	1	1	0	1	0	0	0	Rn			Rd			(1)	(1)	(1)	(1)	1	0	1	1	Rm							

d = UInt(Rd); n = UInt(Rn); m = UInt(Rm);
 if d == 15 || n == 15 || m == 15 then UNPREDICTABLE;

Assembler syntax

SEL<C><q> {<Rd>,>} <Rn>, <Rm>

where:

<C><q> See *Standard assembler syntax fields* on page A8-7.

<Rd> The destination register.

<Rn> The first operand register.

<Rm> The second operand register.

Operation

```
if ConditionPassed() then
    EncodingSpecificOperations();
    R[d]<7:0> = if APSR.GE<0> == '1' then R[n]<7:0> else R[m]<7:0>;
    R[d]<15:8> = if APSR.GE<1> == '1' then R[n]<15:8> else R[m]<15:8>;
    R[d]<23:16> = if APSR.GE<2> == '1' then R[n]<23:16> else R[m]<23:16>;
    R[d]<31:24> = if APSR.GE<3> == '1' then R[n]<31:24> else R[m]<31:24>;
```

Exceptions

None.

A8.6.157 SETEND

Set Endianness writes a new value to ENDIANSTATE.

Encoding T1 ARMv6*, ARMv7

SETEND <endian_specifier>

Not permitted in IT block

15	14	13	12	11	10	9	8	7	6	5	4	3	2	1	0
1	0	1	1	0	1	1	0	0	1	0	(1)	E	(0)	(0)	(0)

```
set_bigend = (E == '1');
if InITBlock() then UNPREDICTABLE;
```

Encoding A1 ARMv6*, ARMv7

SETEND <endian_specifier>

Cannot be conditional

31	30	29	28	27	26	25	24	23	22	21	20	19	18	17	16	15	14	13	12	11	10	9	8	7	6	5	4	3	2	1	0
1	1	1	1	0	0	0	1	0	0	0	0	(0)	(0)	(0)	1	(0)	(0)	(0)	(0)	(0)	(0)	E	(0)	0	0	0	0	(0)	(0)	(0)	(0)

```
set_bigend = (E == '1');
```

Assembler syntax

SETEND<q> <endian_specifier>

where:

<q> See *Standard assembler syntax fields* on page A8-7. A SETEND instruction must be unconditional.

<endian_specifier>

Is one of:

BE Sets the E bit in the instruction. This sets ENDIANSTATE.

LE Clears the E bit in the instruction. This clears ENDIANSTATE.

Operation

```
EncodingSpecificOperations();  
ENDIANSTATE = if set_bigend then '1' else '0';
```

Exceptions

None.

A8.6.158 SEV

Send Event is a hint instruction. It causes an event to be signaled to all processors in the multiprocessor system.

Encoding T1 ARMv7 (executes as NOP in ARMv6T2)

SEV<c>

15	14	13	12	11	10	9	8	7	6	5	4	3	2	1	0
1	0	1	1	1	1	1	1	0	1	0	0	0	0	0	0

// No additional decoding required

Encoding T2 ARMv7 (executes as NOP in ARMv6T2)

SEV<c>.W

15	14	13	12	11	10	9	8	7	6	5	4	3	2	1	0	15	14	13	12	11	10	9	8	7	6	5	4	3	2	1	0
1	1	1	1	0	0	1	1	1	0	1	0	(1)	(1)	(1)	(1)	1	0	(0)	0	(0)	0	0	0	0	0	0	1	0	0		

// No additional decoding required

Encoding A1 ARMv6K, ARMv7 (executes as NOP in ARMv6T2)

SEV<c>

31	30	29	28	27	26	25	24	23	22	21	20	19	18	17	16	15	14	13	12	11	10	9	8	7	6	5	4	3	2	1	0
cond	0	0	1	1	0	0	1	0	0	0	0	0	(1)	(1)	(1)	(1)	(0)	(0)	(0)	(0)	0	0	0	0	0	0	0	1	0	0	

// No additional decoding required

Assembler syntax

SEV<c><q>

where:

<c><q> See *Standard assembler syntax fields* on page A8-7.

Operation

```
if ConditionPassed() then
    EncodingSpecificOperations();
    SendEvent();
```

Exceptions

None.

A8.6.159 SHADD16

Signed Halving Add 16 performs two signed 16-bit integer additions, halves the results, and writes the results to the destination register.

Encoding T1 ARMv6T2, ARMv7

SHADD16<c> <Rd>, <Rn>, <Rm>

15	14	13	12	11	10	9	8	7	6	5	4	3	2	1	0	15	14	13	12	11	10	9	8	7	6	5	4	3	2	1	0
1	1	1	1	1	0	1	0	1	0	0	1	Rn			1	1	1	1	Rd			0	0	1	0	Rm					

d = UInt(Rd); n = UInt(Rn); m = UInt(Rm);
 if BadReg(d) || BadReg(n) || BadReg(m) then UNPREDICTABLE;

Encoding A1 ARMv6*, ARMv7

SHADD16<c> <Rd>, <Rn>, <Rm>

31	30	29	28	27	26	25	24	23	22	21	20	19	18	17	16	15	14	13	12	11	10	9	8	7	6	5	4	3	2	1	0
cond		0	1	1	0	0	0	1	1	Rn			Rd			(1)	(1)	(1)	(1)	0	0	0	1	Rm							

d = UInt(Rd); n = UInt(Rn); m = UInt(Rm);
 if d == 15 || n == 15 || m == 15 then UNPREDICTABLE;

Assembler syntax

SHADD16<c><q> {<Rd>}, <Rn>, <Rm>

where:

<c><q> See *Standard assembler syntax fields* on page A8-7.

<Rd> The destination register.

<Rn> The first operand register.

<Rm> The second operand register.

Operation

```
if ConditionPassed() then
    EncodingSpecificOperations();
    sum1 = SInt(R[n]<15:0>) + SInt(R[m]<15:0>);
    sum2 = SInt(R[n]<31:16>) + SInt(R[m]<31:16>);
    R[d]<15:0> = sum1<16:1>;
    R[d]<31:16> = sum2<16:1>;
```

Exceptions

None.

A8.6.160 SHADD8

Signed Halving Add 8 performs four signed 8-bit integer additions, halves the results, and writes the results to the destination register.

Encoding T1 ARMv6T2, ARMv7

SHADD8<c> <Rd>, <Rn>, <Rm>

15	14	13	12	11	10	9	8	7	6	5	4	3	2	1	0	15	14	13	12	11	10	9	8	7	6	5	4	3	2	1	0
1	1	1	1	1	0	1	0	1	0	0	0	Rn	1	1	1	1	Rd	0	0	1	0	Rm									

d = UInt(Rd); n = UInt(Rn); m = UInt(Rm);
 if BadReg(d) || BadReg(n) || BadReg(m) then UNPREDICTABLE;

Encoding A1 ARMv6*, ARMv7

SHADD8<c> <Rd>, <Rn>, <Rm>

31	30	29	28	27	26	25	24	23	22	21	20	19	18	17	16	15	14	13	12	11	10	9	8	7	6	5	4	3	2	1	0
cond	0	1	1	0	0	0	1	1	Rn	Rd	(1)	(1)	(1)	(1)	1	0	0	1	Rm												

d = UInt(Rd); n = UInt(Rn); m = UInt(Rm);
 if d == 15 || n == 15 || m == 15 then UNPREDICTABLE;

Assembler syntax

SHADD8<c><q> {<Rd>}, <Rn>, <Rm>

where:

<c><q> See *Standard assembler syntax fields* on page A8-7.

<Rd> The destination register.

<Rn> The first operand register.

<Rm> The second operand register.

Operation

```
if ConditionPassed() then
    EncodingSpecificOperations();
    sum1 = SInt(R[n]<7:0>) + SInt(R[m]<7:0>);
    sum2 = SInt(R[n]<15:8>) + SInt(R[m]<15:8>);
    sum3 = SInt(R[n]<23:16>) + SInt(R[m]<23:16>);
    sum4 = SInt(R[n]<31:24>) + SInt(R[m]<31:24>);
    R[d]<7:0> = sum1<8:1>;
    R[d]<15:8> = sum2<8:1>;
    R[d]<23:16> = sum3<8:1>;
    R[d]<31:24> = sum4<8:1>;
```

Exceptions

None.

A8.6.161 SHASX

Signed Halving Add and Subtract with Exchange exchanges the two halfwords of the second operand, performs one signed 16-bit integer addition and one signed 16-bit subtraction, halves the results, and writes the results to the destination register.

Encoding T1 ARMv6T2, ARMv7

SHASX<c> <Rd>, <Rn>, <Rm>

15	14	13	12	11	10	9	8	7	6	5	4	3	2	1	0	15	14	13	12	11	10	9	8	7	6	5	4	3	2	1	0
1	1	1	1	1	0	1	0	1	0	1	0	Rn				1	1	1	1	Rd				0	0	1	0	Rm			

d = UInt(Rd); n = UInt(Rn); m = UInt(Rm);
 if BadReg(d) || BadReg(n) || BadReg(m) then UNPREDICTABLE;

Encoding A1 ARMv6*, ARMv7

SHASX<c> <Rd>, <Rn>, <Rm>

31	30	29	28	27	26	25	24	23	22	21	20	19	18	17	16	15	14	13	12	11	10	9	8	7	6	5	4	3	2	1	0
cond		0	1	1	0	0	0	1	1	Rn				Rd				(1)	(1)	(1)	(1)	0	0	1	1	Rm					

d = UInt(Rd); n = UInt(Rn); m = UInt(Rm);
 if d == 15 || n == 15 || m == 15 then UNPREDICTABLE;

Assembler syntax

SHASX<c><q> {<Rd>}, <Rn>, <Rm>

where:

<c><q> See *Standard assembler syntax fields* on page A8-7.

<Rd> The destination register.

<Rn> The first operand register.

<Rm> The second operand register.

The pre-UAL syntax SHADDSUBX<c> is equivalent to SHASX<c>.

Operation

```
if ConditionPassed() then
    EncodingSpecificOperations();
    diff = SInt(R[n]<15:0>) - SInt(R[m]<31:16>);
    sum = SInt(R[n]<31:16>) + SInt(R[m]<15:0>);
    R[d]<15:0> = diff<16:1>;
    R[d]<31:16> = sum<16:1>;
```

Exceptions

None.

A8.6.162 SHSAX

Signed Halving Subtract and Add with Exchange exchanges the two halfwords of the second operand, performs one signed 16-bit integer subtraction and one signed 16-bit addition, halves the results, and writes the results to the destination register.

Encoding T1 ARMv6T2, ARMv7

SHSAX<c> <Rd>, <Rn>, <Rm>

15	14	13	12	11	10	9	8	7	6	5	4	3	2	1	0	15	14	13	12	11	10	9	8	7	6	5	4	3	2	1	0
1	1	1	1	1	0	1	0	1	1	1	0	Rn			1	1	1	1	Rd			0	0	1	0	Rm					

d = UInt(Rd); n = UInt(Rn); m = UInt(Rm);
 if BadReg(d) || BadReg(n) || BadReg(m) then UNPREDICTABLE;

Encoding A1 ARMv6*, ARMv7

SHSAX<c> <Rd>, <Rn>, <Rm>

31	30	29	28	27	26	25	24	23	22	21	20	19	18	17	16	15	14	13	12	11	10	9	8	7	6	5	4	3	2	1	0
cond		0	1	1	0	0	0	1	1	Rn			Rd			(1)	(1)	(1)	(1)	0	1	0	1	Rm							

d = UInt(Rd); n = UInt(Rn); m = UInt(Rm);
 if d == 15 || n == 15 || m == 15 then UNPREDICTABLE;

Assembler syntax

SHSAX<c><q> {<Rd>,<Rn>, <Rm>

where:

<c><q> See *Standard assembler syntax fields* on page A8-7.

<Rd> The destination register.

<Rn> The first operand register.

<Rm> The second operand register.

The pre-UAL syntax SHSUBADDX<c> is equivalent to SHSAX<c>.

Operation

```
if ConditionPassed() then
    EncodingSpecificOperations();
    sum = SInt(R[n]<15:0>) + SInt(R[m]<31:16>);
    diff = SInt(R[n]<31:16>) - SInt(R[m]<15:0>);
    R[d]<15:0> = sum<16:1>;
    R[d]<31:16> = diff<16:1>;
```

Exceptions

None.

A8.6.163 SHSUB16

Signed Halving Subtract 16 performs two signed 16-bit integer subtractions, halves the results, and writes the results to the destination register.

Encoding T1 ARMv6T2, ARMv7

SHSUB16<c> <Rd>, <Rn>, <Rm>

15	14	13	12	11	10	9	8	7	6	5	4	3	2	1	0	15	14	13	12	11	10	9	8	7	6	5	4	3	2	1	0
1	1	1	1	1	0	1	0	1	1	0	1	Rn			1	1	1	1	Rd			0	0	1	0	Rm					

d = UInt(Rd); n = UInt(Rn); m = UInt(Rm);
 if BadReg(d) || BadReg(n) || BadReg(m) then UNPREDICTABLE;

Encoding A1 ARMv6*, ARMv7

SHSUB16<c> <Rd>, <Rn>, <Rm>

31	30	29	28	27	26	25	24	23	22	21	20	19	18	17	16	15	14	13	12	11	10	9	8	7	6	5	4	3	2	1	0
cond		0	1	1	0	0	0	1	1	Rn			Rd			(1)	(1)	(1)	(1)	0	1	1	1	Rm							

d = UInt(Rd); n = UInt(Rn); m = UInt(Rm);
 if d == 15 || n == 15 || m == 15 then UNPREDICTABLE;

Assembler syntax

SHSUB16<c><q> {<Rd>}, <Rn>, <Rm>

where:

<c><q> See *Standard assembler syntax fields* on page A8-7.

<Rd> The destination register.

<Rn> The first operand register.

<Rm> The second operand register.

Operation

```
if ConditionPassed() then
    EncodingSpecificOperations();
    diff1 = SInt(R[n]<15:0>) - SInt(R[m]<15:0>);
    diff2 = SInt(R[n]<31:16>) - SInt(R[m]<31:16>);
    R[d]<15:0> = diff1<16:1>;
    R[d]<31:16> = diff2<16:1>;
```

Exceptions

None.

A8.6.164 SHSUB8

Signed Halving Subtract 8 performs four signed 8-bit integer subtractions, halves the results, and writes the results to the destination register.

Encoding T1 ARMv6T2, ARMv7

SHSUB8<c> <Rd>, <Rn>, <Rm>

15	14	13	12	11	10	9	8	7	6	5	4	3	2	1	0	15	14	13	12	11	10	9	8	7	6	5	4	3	2	1	0
1	1	1	1	1	0	1	0	1	1	0	0	Rn			1	1	1	1	Rd			0	0	1	0	Rm					

d = UInt(Rd); n = UInt(Rn); m = UInt(Rm);
 if BadReg(d) || BadReg(n) || BadReg(m) then UNPREDICTABLE;

Encoding A1 ARMv6*, ARMv7

SHSUB8<c> <Rd>, <Rn>, <Rm>

31	30	29	28	27	26	25	24	23	22	21	20	19	18	17	16	15	14	13	12	11	10	9	8	7	6	5	4	3	2	1	0
cond		0	1	1	0	0	0	1	1	Rn			Rd			(1)	(1)	(1)	(1)	1	1	1	1	Rm							

d = UInt(Rd); n = UInt(Rn); m = UInt(Rm);
 if d == 15 || n == 15 || m == 15 then UNPREDICTABLE;

Assembler syntax

SHSUB8<c><q> {<Rd>}, <Rn>, <Rm>

where:

<c><q> See *Standard assembler syntax fields* on page A8-7.

<Rd> The destination register.

<Rn> The first operand register.

<Rm> The second operand register.

Operation

```
if ConditionPassed() then
    EncodingSpecificOperations();
    diff1 = SInt(R[n]<7:0>) - SInt(R[m]<7:0>);
    diff2 = SInt(R[n]<15:8>) - SInt(R[m]<15:8>);
    diff3 = SInt(R[n]<23:16>) - SInt(R[m]<23:16>);
    diff4 = SInt(R[n]<31:24>) - SInt(R[m]<31:24>);
    R[d]<7:0>  = diff1<8:1>;
    R[d]<15:8> = diff2<8:1>;
    R[d]<23:16> = diff3<8:1>;
    R[d]<31:24> = diff4<8:1>;
```

Exceptions

None.

A8.6.165 SMC (previously SMI)

Secure Monitor Call is a system instruction. For details see *SMC (previously SMI)* on page B6-18.

A8.6.166 SMLABB, SMLABT, SMLATB, SMLATT

Signed Multiply Accumulate (halfwords) performs a signed multiply-accumulate operation. The multiply acts on two signed 16-bit quantities, taken from either the bottom or the top half of their respective source registers. The other halves of these source registers are ignored. The 32-bit product is added to a 32-bit accumulate value and the result is written to the destination register.

If overflow occurs during the addition of the accumulate value, the instruction sets the Q flag in the APSR. It is not possible for overflow to occur during the multiplication.

Encoding T1 ARMv6T2, ARMv7

SMLA<x><y><c> <Rd>, <Rn>, <Rm>, <Ra>

15	14	13	12	11	10	9	8	7	6	5	4	3	2	1	0	15	14	13	12	11	10	9	8	7	6	5	4	3	2	1	0
1	1	1	1	1	0	1	1	0	0	0	1	Rn				Ra				Rd				0	0	N	M	Rm			

```
if Ra == '1111' then SEE SMULBB, SMULBT, SMULTB, SMULTT;
d = UInt(Rd); n = UInt(Rn); m = UInt(Rm); a = UInt(Ra);
n_high = (N == '1'); m_high = (M == '1');
if BadReg(d) || BadReg(n) || BadReg(m) || a == 13 then UNPREDICTABLE;
```

Encoding A1 ARMv5TE*, ARMv6*, ARMv7

SMLA<x><y><c> <Rd>, <Rn>, <Rm>, <Ra>

31	30	29	28	27	26	25	24	23	22	21	20	19	18	17	16	15	14	13	12	11	10	9	8	7	6	5	4	3	2	1	0
cond				0	0	0	1	0	0	0	0	Rd				Ra				Rm				I	M	N	0	Rn			

```
d = UInt(Rd); n = UInt(Rn); m = UInt(Rm); a = UInt(Ra);
n_high = (N == '1'); m_high = (M == '1');
if d == 15 || n == 15 || m == 15 || a == 15 then UNPREDICTABLE;
```

Assembler syntax

SMLA<x><y><c><q> <Rd>, <Rn>, <Rm>, <Ra>

where:

- <x> Specifies which half of the source register <Rn> is used as the first multiply operand. If <x> is B, then the bottom half (bits [15:0]) of <Rn> is used. If <x> is T, then the top half (bits [31:16]) of <Rn> is used.
- <y> Specifies which half of the source register <Rm> is used as the second multiply operand. If <y> is B, then the bottom half (bits [15:0]) of <Rm> is used. If <y> is T, then the top half (bits [31:16]) of <Rm> is used.
- <c><q> See *Standard assembler syntax fields* on page A8-7.
- <Rd> The destination register.
- <Rn> The source register whose bottom or top half (selected by <x>) is the first multiply operand.
- <Rm> The source register whose bottom or top half (selected by <y>) is the second multiply operand.
- <Ra> The register that contains the accumulate value.

Operation

```

if ConditionPassed() then
    EncodingSpecificOperations();
    operand1 = if n_high then R[n]<31:16> else R[n]<15:0>;
    operand2 = if m_high then R[m]<31:16> else R[m]<15:0>;
    result = SInt(operand1) * SInt(operand2) + SInt(R[a]);
    R[d] = result<31:0>;
    if result != SInt(result<31:0>) then // Signed overflow
        APSR.Q = '1';

```

Exceptions

None.

A8.6.167 SMLAD

Signed Multiply Accumulate Dual performs two signed 16 x 16-bit multiplications. It adds the products to a 32-bit accumulate operand.

Optionally, you can exchange the halfwords of the second operand before performing the arithmetic. This produces top × bottom and bottom × top multiplication.

This instruction sets the Q flag if the accumulate operation overflows. Overflow cannot occur during the multiplications.

Encoding T1 ARMv6T2, ARMv7

SMLAD{X}<c> <Rd>, <Rn>, <Rm>, <Ra>

15	14	13	12	11	10	9	8	7	6	5	4	3	2	1	0	15	14	13	12	11	10	9	8	7	6	5	4	3	2	1	0
1	1	1	1	1	0	1	1	0	0	1	0	Rn				Ra				Rd				0	0	0	M	Rm			

```

if Ra == '1111' then SEE SMUAD;
d = UInt(Rd); n = UInt(Rn); m = UInt(Rm); a = UInt(Ra);
m_swap = (M == '1');
if BadReg(d) || BadReg(n) || BadReg(m) || a == 13 then UNPREDICTABLE;
    
```

Encoding A1 ARMv6*, ARMv7

SMLAD{X}<c> <Rd>, <Rn>, <Rm>, <Ra>

31	30	29	28	27	26	25	24	23	22	21	20	19	18	17	16	15	14	13	12	11	10	9	8	7	6	5	4	3	2	1	0
cond		0	1	1	1	0	0	0	0	Rd				Ra				Rm				0	0	M	1	Rn					

```

if Ra == '1111' then SEE SMUAD;
d = UInt(Rd); n = UInt(Rn); m = UInt(Rm); a = UInt(Ra);
m_swap = (M == '1');
if d == 15 || n == 15 || m == 15 then UNPREDICTABLE;
    
```

Assembler syntax

SMLAD{X}<C><q> <Rd>, <Rn>, <Rm>, <Ra>

where:

- X If X is present (encoded as M == 1), the multiplications are bottom × top and top × bottom.
 If the X is omitted (encoded as M == 0), the multiplications are bottom × bottom and top × top.
- <C><q> See *Standard assembler syntax fields* on page A8-7.
- <Rd> The destination register.
- <Rn> The first operand register.
- <Rm> The second operand register.
- <Ra> The register that contains the accumulate value.

Operation

```
if ConditionPassed() then
    EncodingSpecificOperations();
    operand2 = if m_swap then ROR(R[m],16) else R[m];
    product1 = SInt(R[n]<15:0>) * SInt(operand2<15:0>);
    product2 = SInt(R[n]<31:16>) * SInt(operand2<31:16>);
    result = product1 + product2 + SInt(R[a]);
    R[d] = result<31:0>;
    if result != SInt(result<31:0>) then // Signed overflow
        APSR.Q = '1';
```

Exceptions

None.

A8.6.168 SMLAL

Signed Multiply Accumulate Long multiplies two signed 32-bit values to produce a 64-bit value, and accumulates this with a 64-bit value.

In ARM code, the condition flags can optionally be updated based on the result. Use of this option adversely affects performance on many processor implementations.

Encoding T1 ARMv6T2, ARMv7

SMLAL<C> <RdLo>, <RdHi>, <Rn>, <Rm>

15	14	13	12	11	10	9	8	7	6	5	4	3	2	1	0	15	14	13	12	11	10	9	8	7	6	5	4	3	2	1	0
1	1	1	1	1	0	1	1	1	1	0	0	Rn				RdLo				RdHi				0 0 0 0				Rm			

```
dLo = UInt(RdLo); dHi = UInt(RdHi); n = UInt(Rn); m = UInt(Rm); setflags = FALSE;
if BadReg(dLo) || BadReg(dHi) || BadReg(n) || BadReg(m) then UNPREDICTABLE;
if dHi == dLo then UNPREDICTABLE;
```

Encoding A1 ARMv4*, ARMv5T*, ARMv6*, ARMv7

SMLAL{S}<C> <RdLo>, <RdHi>, <Rn>, <Rm>

31	30	29	28	27	26	25	24	23	22	21	20	19	18	17	16	15	14	13	12	11	10	9	8	7	6	5	4	3	2	1	0	
cond				0 0 0 0				1 1 1				S	RdHi				RdLo				Rm				1 0 0 1				Rn			

```
dLo = UInt(RdLo); dHi = UInt(RdHi); n = UInt(Rn); m = UInt(Rm); setflags = (S == '1');
if dLo == 15 || dHi == 15 || n == 15 || m == 15 then UNPREDICTABLE;
if dHi == dLo then UNPREDICTABLE;
if ArchVersion() < 6 && (dHi == n || dLo == n) then UNPREDICTABLE;
```

Assembler syntax

SMLAL{S}<c><q> <RdLo>, <RdHi>, <Rn>, <Rm>

where:

- S If S is present, the instruction updates the flags. Otherwise, the flags are not updated.
S can be specified only for the ARM instruction set.
- <c><q> See *Standard assembler syntax fields* on page A8-7.
- <RdLo> Supplies the lower 32 bits of the accumulate value, and is the destination register for the lower 32 bits of the result.
- <RdHi> Supplies the upper 32 bits of the accumulate value, and is the destination register for the upper 32 bits of the result.
- <Rn> The first operand register.
- <Rm> The second operand register.

The pre-UAL syntax SMLAL<c>S is equivalent to SMLALS<c>.

Operation

```

if ConditionPassed() then
    EncodingSpecificOperations();
    result = SInt(R[n]) * SInt(R[m]) + SInt(R[dHi]:R[dLo]);
    R[dHi] = result<63:32>;
    R[dLo] = result<31:0>;
    if setflags then
        APSR.N = result<63>;
        APSR.Z = IsZeroBit(result<63:0>);
        if ArchVersion() == 4 then
            APSR.C = bit UNKNOWN;
            APSR.V = bit UNKNOWN;
        // else APSR.C, APSR.V unchanged

```

Exceptions

None.

A8.6.169 SMLALBB, SMLALBT, SMLALTB, SMLALTT

Signed Multiply Accumulate Long (halfwords) multiplies two signed 16-bit values to produce a 32-bit value, and accumulates this with a 64-bit value. The multiply acts on two signed 16-bit quantities, taken from either the bottom or the top half of their respective source registers. The other halves of these source registers are ignored. The 32-bit product is sign-extended and accumulated with a 64-bit accumulate value.

Overflow is possible during this instruction, but only as a result of the 64-bit addition. This overflow is not detected if it occurs. Instead, the result wraps around modulo 2^{64} .

Encoding T1 ARMv6T2, ARMv7

SMLAL<x><y><c> <RdLo>, <RdHi>, <Rn>, <Rm>

15	14	13	12	11	10	9	8	7	6	5	4	3	2	1	0	15	14	13	12	11	10	9	8	7	6	5	4	3	2	1	0
1	1	1	1	1	0	1	1	1	1	0	0	Rn			RdLo			RdHi			1	0	N	M	Rm						

```
dLo = UInt(RdLo); dHi = UInt(RdHi); n = UInt(Rn); m = UInt(Rm);
n_high = (N == '1'); m_high = (M == '1');
if BadReg(dLo) || BadReg(dHi) || BadReg(n) || BadReg(m) then UNPREDICTABLE;
if dHi == dLo then UNPREDICTABLE;
```

Encoding A1 ARMv5TE*, ARMv6*, ARMv7

SMLAL<x><y><c> <RdLo>, <RdHi>, <Rn>, <Rm>

31	30	29	28	27	26	25	24	23	22	21	20	19	18	17	16	15	14	13	12	11	10	9	8	7	6	5	4	3	2	1	0
cond		0	0	0	1	0	1	0	0	RdHi			RdLo			Rm		1	M	N	0	Rn									

```
dLo = UInt(RdLo); dHi = UInt(RdHi); n = UInt(Rn); m = UInt(Rm);
n_high = (N == '1'); m_high = (M == '1');
if dLo == 15 || dHi == 15 || n == 15 || m == 15 then UNPREDICTABLE;
if dHi == dLo then UNPREDICTABLE;
```

Assembler syntax

SMLAL<x><y><c><q> <RdLo>, <RdHi>, <Rn>, <Rm>

where:

- <x> Specifies which half of the source register <Rn> is used as the first multiply operand. If <x> is B, then the bottom half (bits [15:0]) of <Rn> is used. If <x> is T, then the top half (bits [31:16]) of <Rn> is used.
- <y> Specifies which half of the source register <Rm> is used as the second multiply operand. If <y> is B, then the bottom half (bits [15:0]) of <Rm> is used. If <y> is T, then the top half (bits [31:16]) of <Rm> is used.
- <c><q> See *Standard assembler syntax fields* on page A8-7.
- <RdLo> Supplies the lower 32 bits of the accumulate value, and is the destination register for the lower 32 bits of the result.
- <RdHi> Supplies the upper 32 bits of the accumulate value, and is the destination register for the upper 32 bits of the result.
- <Rn> The source register whose bottom or top half (selected by <x>) is the first multiply operand.
- <Rm> The source register whose bottom or top half (selected by <y>) is the second multiply operand.

Operation

```

if ConditionPassed() then
    EncodingSpecificOperations();
    operand1 = if n_high then R[n]<31:16> else R[n]<15:0>;
    operand2 = if m_high then R[m]<31:16> else R[m]<15:0>;
    result = SInt(operand1) * SInt(operand2) + SInt(R[dHi]:R[dLo]);
    R[dHi] = result<63:32>;
    R[dLo] = result<31:0>;

```

Exceptions

None.

A8.6.170 SMLALD

Signed Multiply Accumulate Long Dual performs two signed 16×16 -bit multiplications. It adds the products to a 64-bit accumulate operand.

Optionally, you can exchange the halfwords of the second operand before performing the arithmetic. This produces top \times bottom and bottom \times top multiplication.

Overflow is possible during this instruction, but only as a result of the 64-bit addition. This overflow is not detected if it occurs. Instead, the result wraps around modulo 2^{64} .

Encoding T1 ARMv6T2, ARMv7

SMLALD{X}<c> <RdLo>, <RdHi>, <Rn>, <Rm>

15	14	13	12	11	10	9	8	7	6	5	4	3	2	1	0	15	14	13	12	11	10	9	8	7	6	5	4	3	2	1	0
1	1	1	1	1	0	1	1	1	1	0	0	Rn			RdLo			RdHi			1	1	0	M	Rm						

```
dLo = UInt(RdLo); dHi = UInt(RdHi); n = UInt(Rn); m = UInt(Rm); m_swap = (M == '1');
if BadReg(dLo) || BadReg(dHi) || BadReg(n) || BadReg(m) then UNPREDICTABLE;
if dHi == dLo then UNPREDICTABLE;
```

Encoding A1 ARMv6*, ARMv7

SMLALD{X}<c> <RdLo>, <RdHi>, <Rn>, <Rm>

31	30	29	28	27	26	25	24	23	22	21	20	19	18	17	16	15	14	13	12	11	10	9	8	7	6	5	4	3	2	1	0
cond		0	1	1	1	0	1	0	0	RdHi			RdLo			Rm			0	0	M	1	Rn								

```
dLo = UInt(RdLo); dHi = UInt(RdHi); n = UInt(Rn); m = UInt(Rm); m_swap = (M == '1');
if dLo == 15 || dHi == 15 || n == 15 || m == 15 then UNPREDICTABLE;
if dHi == dLo then UNPREDICTABLE;
```

Assembler syntax

SMLALD{X}<c><q> <RdLo>, <RdHi>, <Rn>, <Rm>

where:

X	If X is present, the multiplications are bottom \times top and top \times bottom. If the X is omitted, the multiplications are bottom \times bottom and top \times top.
<c><q>	See <i>Standard assembler syntax fields</i> on page A8-7.
<RdLo>	Supplies the lower 32 bits of the accumulate value, and is the destination register for the lower 32 bits of the result.
<RdHi>	Supplies the upper 32 bits of the accumulate value, and is the destination register for the upper 32 bits of the result.
<Rn>	The first operand register.
<Rm>	The second operand register.

Operation

```

if ConditionPassed() then
    EncodingSpecificOperations();
    operand2 = if m_swap then ROR(R[m],16) else R[m];
    product1 = SInt(R[n]<15:0>) * SInt(operand2<15:0>);
    product2 = SInt(R[n]<31:16>) * SInt(operand2<31:16>);
    result = product1 + product2 + SInt(R[dHi]:R[dLo]);
    R[dHi] = result<63:32>;
    R[dLo] = result<31:0>;

```

Exceptions

None.

A8.6.171 SMLAWB, SMLAWT

Signed Multiply Accumulate (word by halfword) performs a signed multiply-accumulate operation. The multiply acts on a signed 32-bit quantity and a signed 16-bit quantity. The signed 16-bit quantity is taken from either the bottom or the top half of its source register. The other half of the second source register is ignored. The top 32 bits of the 48-bit product are added to a 32-bit accumulate value and the result is written to the destination register. The bottom 16 bits of the 48-bit product are ignored.

If overflow occurs during the addition of the accumulate value, the instruction sets the Q flag in the APSR. No overflow can occur during the multiplication.

Encoding T1 ARMv6T2, ARMv7

SMLAW<y><c> <Rd>, <Rn>, <Rm>, <Ra>

15	14	13	12	11	10	9	8	7	6	5	4	3	2	1	0	15	14	13	12	11	10	9	8	7	6	5	4	3	2	1	0
1	1	1	1	1	0	1	1	0	0	1	1	Rn				Ra				Rd				0	0	0	M	Rm			

```
if Ra == '1111' then SEE SMULWB, SMULWT;
d = UInt(Rd); n = UInt(Rn); m = UInt(Rm); a = UInt(Ra); m_high = (M == '1');
if BadReg(d) || BadReg(n) || BadReg(m) || a == 13 then UNPREDICTABLE;
```

Encoding A1 ARMv5TE*, ARMv6*, ARMv7

SMLAW<y><c> <Rd>, <Rn>, <Rm>, <Ra>

31	30	29	28	27	26	25	24	23	22	21	20	19	18	17	16	15	14	13	12	11	10	9	8	7	6	5	4	3	2	1	0
cond				0	0	0	1	0	0	1	0	Rd				Ra				Rm				1	M	0	0	Rn			

```
d = UInt(Rd); n = UInt(Rn); m = UInt(Rm); a = UInt(Ra); m_high = (M == '1');
if d == 15 || n == 15 || m == 15 || a == 15 then UNPREDICTABLE;
```

Assembler syntax

SMLAW<y><c><q> <Rd>, <Rn>, <Rm>, <Ra>

where:

<y>	Specifies which half of the source register <Rm> is used as the second multiply operand. If <y> is B, then the bottom half (bits [15:0]) of <Rm> is used. If <y> is T, then the top half (bits [31:16]) of <Rm> is used.
<c><q>	See <i>Standard assembler syntax fields</i> on page A8-7.
<Rd>	The destination register.
<Rn>	The first operand register.
<Rm>	The source register whose bottom or top half (selected by <y>) is the second multiply operand.
<Ra>	The register that contains the accumulate value.

Operation

```

if ConditionPassed() then
    EncodingSpecificOperations();
    operand2 = if m_high then R[m]<31:16> else R[m]<15:0>;
    result = SInt(R[n]) * SInt(operand2) + (SInt(R[a]) << 16);
    R[d] = result<47:16>;
    if (result >> 16) != SInt(R[d]) then // Signed overflow
        APSR.Q = '1';

```

Exceptions

None.

A8.6.172 SMLSD

Signed Multiply Subtract Dual performs two signed 16 × 16-bit multiplications. It adds the difference of the products to a 32-bit accumulate operand.

Optionally, you can exchange the halfwords of the second operand before performing the arithmetic. This produces top × bottom and bottom × top multiplication.

This instruction sets the Q flag if the accumulate operation overflows. Overflow cannot occur during the multiplications or subtraction.

Encoding T1 ARMv6T2, ARMv7

SMLSD{X}<c> <Rd>, <Rn>, <Rm>, <Ra>

15	14	13	12	11	10	9	8	7	6	5	4	3	2	1	0	15	14	13	12	11	10	9	8	7	6	5	4	3	2	1	0
1	1	1	1	1	0	1	1	0	1	0	0	Rn				Ra				Rd				0	0	0	M	Rm			

```
if Ra == '1111' then SEE SMUSD;
d = UInt(Rd); n = UInt(Rn); m = UInt(Rm); a = UInt(Ra); m_swap = (M == '1');
if BadReg(d) || BadReg(n) || BadReg(m) || a == 13 then UNPREDICTABLE;
```

Encoding A1 ARMv6*, ARMv7

SMLSD{X}<c> <Rd>, <Rn>, <Rm>, <Ra>

31	30	29	28	27	26	25	24	23	22	21	20	19	18	17	16	15	14	13	12	11	10	9	8	7	6	5	4	3	2	1	0
cond		0	1	1	1	0	0	0	0	Rd				Ra				Rm				0	1	M	1	Rn					

```
if Ra == '1111' then SEE SMUSD;
d = UInt(Rd); n = UInt(Rn); m = UInt(Rm); a = UInt(Ra); m_swap = (M == '1');
if d == 15 || n == 15 || m == 15 then UNPREDICTABLE;
```

Assembler syntax

SMLSD{X}<C><q> <Rd>, <Rn>, <Rm>, <Ra>

where:

X	If X is present, the multiplications are bottom \times top and top \times bottom. If the X is omitted, the multiplications are bottom \times bottom and top \times top.
<C><q>	See <i>Standard assembler syntax fields</i> on page A8-7.
<Rd>	The destination register.
<Rn>	The first operand register.
<Rm>	The second operand register.
<Ra>	The register that contains the accumulate value.

Operation

```

if ConditionPassed() then
    EncodingSpecificOperations();
    operand2 = if m_swap then ROR(R[m],16) else R[m];
    product1 = SInt(R[n]<15:0>) * SInt(operand2<15:0>);
    product2 = SInt(R[n]<31:16>) * SInt(operand2<31:16>);
    result = product1 - product2 + SInt(R[a]);
    R[d] = result<31:0>;
    if result != SInt(result<31:0>) then // Signed overflow
        APSR.Q = '1';

```

Exceptions

None.

A8.6.173 SMLS LD

Signed Multiply Subtract Long Dual performs two signed 16×16 -bit multiplications. It adds the difference of the products to a 64-bit accumulate operand.

Optionally, you can exchange the halfwords of the second operand before performing the arithmetic. This produces top \times bottom and bottom \times top multiplication.

Overflow is possible during this instruction, but only as a result of the 64-bit addition. This overflow is not detected if it occurs. Instead, the result wraps around modulo 2^{64} .

Encoding T1 ARMv6T2, ARMv7

SMLS LD{X}<c> <RdLo>, <RdHi>, <Rn>, <Rm>

15	14	13	12	11	10	9	8	7	6	5	4	3	2	1	0	15	14	13	12	11	10	9	8	7	6	5	4	3	2	1	0
1	1	1	1	1	0	1	1	1	1	0	1	Rn				RdLo				RdHi				1	1	0	M	Rm			

```
dLo = UInt(RdLo); dHi = UInt(RdHi); n = UInt(Rn); m = UInt(Rm); m_swap = (M == '1');
if BadReg(dLo) || BadReg(dHi) || BadReg(n) || BadReg(m) then UNPREDICTABLE;
if dHi == dLo then UNPREDICTABLE;
```

Encoding A1 ARMv6*, ARMv7

SMLS LD{X}<c> <RdLo>, <RdHi>, <Rn>, <Rm>

31	30	29	28	27	26	25	24	23	22	21	20	19	18	17	16	15	14	13	12	11	10	9	8	7	6	5	4	3	2	1	0
cond		0	1	1	1	0	1	0	0	RdHi				RdLo				Rm				0	1	M	1	Rn					

```
dLo = UInt(RdLo); dHi = UInt(RdHi); n = UInt(Rn); m = UInt(Rm); m_swap = (M == '1');
if dLo == 15 || dHi == 15 || n == 15 || m == 15 then UNPREDICTABLE;
if dHi == dLo then UNPREDICTABLE;
```

Assembler syntax

SMLSLD{X}<c><q> <RdLo>, <RdHi>, <Rn>, <Rm>

where:

X	If X is present, the multiplications are bottom \times top and top \times bottom. If the X is omitted, the multiplications are bottom \times bottom and top \times top.
<c><q>	See <i>Standard assembler syntax fields</i> on page A8-7.
<RdLo>	Supplies the lower 32 bits of the accumulate value, and is the destination register for the lower 32 bits of the result.
<RdHi>	Supplies the upper 32 bits of the accumulate value, and is the destination register for the upper 32 bits of the result.
<Rn>	The first operand register.
<Rm>	The second operand register.

Operation

```

if ConditionPassed() then
    EncodingSpecificOperations();
    operand2 = if m_swap then ROR(R[m],16) else R[m];
    product1 = SInt(R[n]<15:0>) * SInt(operand2<15:0>);
    product2 = SInt(R[n]<31:16>) * SInt(operand2<31:16>);
    result = product1 - product2 + SInt(R[dHi]:R[dLo]);
    R[dHi] = result<63:32>;
    R[dLo] = result<31:0>;

```

Exceptions

None.

A8.6.174 SMMLA

Signed Most Significant Word Multiply Accumulate multiplies two signed 32-bit values, extracts the most significant 32 bits of the result, and adds an accumulate value.

Optionally, you can specify that the result is rounded instead of being truncated. In this case, the constant 0x80000000 is added to the product before the high word is extracted.

Encoding T1 ARMv6T2, ARMv7

SMMLA{R}<C> <Rd>, <Rn>, <Rm>, <Ra>

15	14	13	12	11	10	9	8	7	6	5	4	3	2	1	0	15	14	13	12	11	10	9	8	7	6	5	4	3	2	1	0
1	1	1	1	1	0	1	1	0	1	0	1	Rn			Ra			Rd			0	0	0	R	Rm						

```
if Ra == '1111' then SEE SMMUL;
d = UInt(Rd); n = UInt(Rn); m = UInt(Rm); a = UInt(Ra); round = (R == '1');
if BadReg(d) || BadReg(n) || BadReg(m) || a == 13 then UNPREDICTABLE;
```

Encoding A1 ARMv6*, ARMv7

SMMLA{R}<C> <Rd>, <Rn>, <Rm>, <Ra>

31	30	29	28	27	26	25	24	23	22	21	20	19	18	17	16	15	14	13	12	11	10	9	8	7	6	5	4	3	2	1	0
cond		0	1	1	1	0	1	0	1	Rd			Ra			Rm			0	0	R	1	Rn								

```
if Ra == '1111' then SEE SMMUL;
d = UInt(Rd); n = UInt(Rn); m = UInt(Rm); a = UInt(Ra); round = (R == '1');
if d == 15 || n == 15 || m == 15 then UNPREDICTABLE;
```

Assembler syntax

SMMLA{R}<C><Q> <Rd>, <Rn>, <Rm>, <Ra>

where:

R	If R is present, the multiplication is rounded. If the R is omitted, the multiplication is truncated.
<C><Q>	See <i>Standard assembler syntax fields</i> on page A8-7.
<Rd>	The destination register.
<Rn>	The register that contains the first multiply operand.
<Rm>	The register that contains the second multiply operand.
<Ra>	The register that contains the accumulate value.

Operation

```

if ConditionPassed() then
    EncodingSpecificOperations();
    result = (SInt(R[a]) << 32) + SInt(R[n]) * SInt(R[m]);
    if round then result = result + 0x80000000;
    R[d] = result<63:32>;

```

Exceptions

None.

A8.6.175 SMMLS

Signed Most Significant Word Multiply Subtract multiplies two signed 32-bit values, ~~extracts the most significant 32 bits of the result, and subtracts it from an accumulate value.~~

Optionally, you can specify that the result is rounded instead of being truncated. In this case, the constant 0x80000000 is added to ~~the product~~ before the high word is extracted.

Encoding T1 ARMv6T2, ARMv7

SMMLS{R}<c> <Rd>, <Rn>, <Rm>, <Ra>

15	14	13	12	11	10	9	8	7	6	5	4	3	2	1	0	15	14	13	12	11	10	9	8	7	6	5	4	3	2	1	0
1	1	1	1	1	0	1	1	0	1	1	0	Rn			Ra			Rd			0	0	0	R	Rm						

d = UInt(Rd); n = UInt(Rn); m = UInt(Rm); a = UInt(Ra); round = (R == '1');
 if BadReg(d) || BadReg(n) || BadReg(m) || BadReg(a) then UNPREDICTABLE;

Encoding A1 ARMv6*, ARMv7

SMMLS{R}<c> <Rd>, <Rn>, <Rm>, <Ra>

31	30	29	28	27	26	25	24	23	22	21	20	19	18	17	16	15	14	13	12	11	10	9	8	7	6	5	4	3	2	1	0
cond		0	1	1	1	0	1	0	1	Rd			Ra			Rm			1	1	R	1	Rn								

d = UInt(Rd); n = UInt(Rn); m = UInt(Rm); a = UInt(Ra); round = (R == '1');
 if d == 15 || n == 15 || m == 15 || a == 15 then UNPREDICTABLE;

Assembler syntax

SMMLS{R}<C><Q> <Rd>, <Rn>, <Rm>, <Ra>

where:

R	If R is present, the multiplication is rounded. If the R is omitted, the multiplication is truncated.
<C><Q>	See <i>Standard assembler syntax fields</i> on page A8-7.
<Rd>	The destination register.
<Rn>	The register that contains the first multiply operand.
<Rm>	The register that contains the second multiply operand.
<Ra>	The register that contains the accumulate value.

Operation

```
if ConditionPassed() then
    EncodingSpecificOperations();
    result = (SInt(R[a]) << 32) - SInt(R[n]) * SInt(R[m]);
    if round then result = result + 0x80000000;
    R[d] = result<63:32>;
```

Exceptions

None.

A8.6.176 SMMUL

Signed Most Significant Word Multiply multiplies two signed 32-bit values, extracts the most significant 32 bits of the result, and writes those bits to the destination register.

Optionally, you can specify that the result is rounded instead of being truncated. In this case, the constant 0x80000000 is added to the product before the high word is extracted.

Encoding T1 ARMv6T2, ARMv7

SMMUL{R}<c> <Rd>, <Rn>, <Rm>

15	14	13	12	11	10	9	8	7	6	5	4	3	2	1	0	15	14	13	12	11	10	9	8	7	6	5	4	3	2	1	0
1	1	1	1	1	0	1	1	0	1	0	1	Rn				1	1	1	1	Rd				0	0	0	R	Rm			

d = UInt(Rd); n = UInt(Rn); m = UInt(Rm); round = (R == '1');
 if BadReg(d) || BadReg(n) || BadReg(m) then UNPREDICTABLE;

Encoding A1 ARMv6*, ARMv7

SMMUL{R}<c> <Rd>, <Rn>, <Rm>

31	30	29	28	27	26	25	24	23	22	21	20	19	18	17	16	15	14	13	12	11	10	9	8	7	6	5	4	3	2	1	0
cond		0	1	1	1	0	1	0	1	Rd				1	1	1	1	Rm				0	0	R	1	Rn					

d = UInt(Rd); n = UInt(Rn); m = UInt(Rm); round = (R == '1');
 if d == 15 || n == 15 || m == 15 then UNPREDICTABLE;

Assembler syntax

SMMUL{R}<C><Q> {<Rd>,<Rn>, <Rm>

where:

R	If R is present, the multiplication is rounded. If the R is omitted, the multiplication is truncated.
<C><Q>	See <i>Standard assembler syntax fields</i> on page A8-7.
<Rd>	The destination register.
<Rn>	The first operand register.
<Rm>	The second operand register.

Operation

```
if ConditionPassed() then
    EncodingSpecificOperations();
    result = SInt(R[n]) * SInt(R[m]);
    if round then result = result + 0x80000000;
    R[d] = result<63:32>;
```

Exceptions

None.

A8.6.177 SMUAD

Signed Dual Multiply Add performs two signed 16×16 -bit multiplications. It adds the products together, and writes the result to the destination register.

Optionally, you can exchange the halfwords of the second operand before performing the arithmetic. This produces top \times bottom and bottom \times top multiplication.

This instruction sets the Q flag if the addition overflows. The multiplications cannot overflow.

Encoding T1 ARMv6T2, ARMv7

SMUAD{X}<c> <Rd>, <Rn>, <Rm>

15	14	13	12	11	10	9	8	7	6	5	4	3	2	1	0	15	14	13	12	11	10	9	8	7	6	5	4	3	2	1	0
1	1	1	1	1	0	1	1	0	0	1	0	Rn				1	1	1	1	Rd				0	0	0	M	Rm			

```
d = UInt(Rd); n = UInt(Rn); m = UInt(Rm); m_swap = (M == '1');
if BadReg(d) || BadReg(n) || BadReg(m) then UNPREDICTABLE;
```

Encoding A1 ARMv6*, ARMv7

SMUAD{X}<c> <Rd>, <Rn>, <Rm>

31	30	29	28	27	26	25	24	23	22	21	20	19	18	17	16	15	14	13	12	11	10	9	8	7	6	5	4	3	2	1	0
cond		0	1	1	1	0	0	0	0	Rd				1	1	1	1	Rm				0	0	M	1	Rn					

```
d = UInt(Rd); n = UInt(Rn); m = UInt(Rm); m_swap = (M == '1');
if d == 15 || n == 15 || m == 15 then UNPREDICTABLE;
```

Assembler syntax

SMUAD{x}<c><q> {<Rd>,<Rn>, <Rm>

where:

X	If X is present, the multiplications are bottom × top and top × bottom. If the X is omitted, the multiplications are bottom × bottom and top × top.
<c><q>	See <i>Standard assembler syntax fields</i> on page A8-7.
<Rd>	The destination register.
<Rn>	The first operand register.
<Rm>	The second operand register.

Operation

```

if ConditionPassed() then
    EncodingSpecificOperations();
    operand2 = if m_swap then ROR(R[m],16) else R[m];
    product1 = SInt(R[n]<15:0>) * SInt(operand2<15:0>);
    product2 = SInt(R[n]<31:16>) * SInt(operand2<31:16>);
    result = product1 + product2;
    R[d] = result<31:0>;
    if result != SInt(result<31:0>) then // Signed overflow
        APSR.Q = '1';

```

Exceptions

None.

A8.6.178 SMULBB, SMULBT, SMULTB, SMULTT

Signed Multiply (halfwords) multiplies two signed 16-bit quantities, taken from either the bottom or the top half of their respective source registers. The other halves of these source registers are ignored. The 32-bit product is written to the destination register. No overflow is possible during this instruction.

Encoding T1 ARMv6T2, ARMv7

SMUL<x><y><c> <Rd>, <Rn>, <Rm>

15	14	13	12	11	10	9	8	7	6	5	4	3	2	1	0	15	14	13	12	11	10	9	8	7	6	5	4	3	2	1	0
1	1	1	1	1	0	1	1	0	0	0	1	Rn				1	1	1	1	Rd				0	0	N	M	Rm			

d = UInt(Rd); n = UInt(Rn); m = UInt(Rm);
n_high = (N == '1'); m_high = (M == '1');
if BadReg(d) || BadReg(n) || BadReg(m) then UNPREDICTABLE;

Encoding A1 ARMv5TE*, ARMv6*, ARMv7

SMUL<x><y><c> <Rd>, <Rn>, <Rm>

31	30	29	28	27	26	25	24	23	22	21	20	19	18	17	16	15	14	13	12	11	10	9	8	7	6	5	4	3	2	1	0
cond		0	0	0	1	0	1	1	0	Rd				SBZ				Rm				1	M	N	0	Rn					

d = UInt(Rd); n = UInt(Rn); m = UInt(Rm);
n_high = (N == '1'); m_high = (M == '1');
if d == 15 || n == 15 || m == 15 then UNPREDICTABLE;

Assembler syntax

SMUL<x><y><c><q> {<Rd>}, <Rn>, <Rm>

where:

- <x> Specifies which half of the source register <Rn> is used as the first multiply operand. If <x> is B, then the bottom half (bits [15:0]) of <Rn> is used. If <x> is T, then the top half (bits [31:16]) of <Rn> is used.
- <y> Specifies which half of the source register <Rm> is used as the second multiply operand. If <y> is B, then the bottom half (bits [15:0]) of <Rm> is used. If <y> is T, then the top half (bits [31:16]) of <Rm> is used.
- <c><q> See *Standard assembler syntax fields* on page A8-7.
- <Rd> The destination register.
- <Rn> The source register whose bottom or top half (selected by <x>) is the first multiply operand.
- <Rm> The source register whose bottom or top half (selected by <y>) is the second multiply operand.

Operation

```
if ConditionPassed() then
    EncodingSpecificOperations();
    operand1 = if n_high then R[n]<31:16> else R[n]<15:0>;
    operand2 = if m_high then R[m]<31:16> else R[m]<15:0>;
    result = SInt(operand1) * SInt(operand2);
    R[d] = result<31:0>;
    // Signed overflow cannot occur
```

Exceptions

None.

A8.6.179 SMULL

Signed Multiply Long multiplies two 32-bit signed values to produce a 64-bit result.

In ARM code, the condition flags can optionally be updated based on the result. Use of this option adversely affects performance on many processor implementations.

Encoding T1 ARMv6T2, ARMv7

SMULL<c> <RdLo>, <RdHi>, <Rn>, <Rm>

15	14	13	12	11	10	9	8	7	6	5	4	3	2	1	0	15	14	13	12	11	10	9	8	7	6	5	4	3	2	1	0
1	1	1	1	1	0	1	1	1	0	0	0	Rn			RdLo			RdHi			0 0 0 0			Rm							

```
dLo = UInt(RdLo); dHi = UInt(RdHi); n = UInt(Rn); m = UInt(Rm); setflags = FALSE;
if BadReg(dLo) || BadReg(dHi) || BadReg(n) || BadReg(m) then UNPREDICTABLE;
if dHi == dLo then UNPREDICTABLE;
```

Encoding A1 ARMv4*, ARMv5T*, ARMv6*, ARMv7

SMULL{S}<c> <RdLo>, <RdHi>, <Rn>, <Rm>

31	30	29	28	27	26	25	24	23	22	21	20	19	18	17	16	15	14	13	12	11	10	9	8	7	6	5	4	3	2	1	0
cond		0 0 0 0				1 1 0		S	RdHi				RdLo				Rm				1 0 0 1		Rn								

```
dLo = UInt(RdLo); dHi = UInt(RdHi); n = UInt(Rn); m = UInt(Rm); setflags = (S == '1');
if dLo == 15 || dHi == 15 || n == 15 || m == 15 then UNPREDICTABLE;
if dHi == dLo then UNPREDICTABLE;
if ArchVersion() < 6 && (dHi == n || dLo == m) then UNPREDICTABLE;
```

Assembler syntax

SMULL{S}<c><q> <RdLo>, <RdHi>, <Rn>, <Rm>

where:

S If S is present, the instruction updates the flags. Otherwise, the flags are not updated.

S can be specified only for the ARM instruction set.

<c><q> See *Standard assembler syntax fields* on page A8-7.

<RdLo> Stores the lower 32 bits of the result.

<RdHi> Stores the upper 32 bits of the result.

<Rn> The first operand register.

<Rm> The second operand register.

The pre-UAL syntax SMULL<c>S is equivalent to SMULLS<c>.

Operation

```
if ConditionPassed() then
    EncodingSpecificOperations();
    result = SInt(R[n]) * SInt(R[m]);
    R[dHi] = result<63:32>;
    R[dLo] = result<31:0>;
    if setflags then
        APSR.N = result<63>;
        APSR.Z = IsZeroBit(result<63:0>);
        if ArchVersion() == 4 then
            APSR.C = bit UNKNOWN;
            APSR.V = bit UNKNOWN;
        // else APSR.C, APSR.V unchanged
```

Exceptions

None.

A8.6.180 SMULWB, SMULWT

Signed Multiply (word by halfword) multiplies a signed 32-bit quantity and a signed 16-bit quantity. The signed 16-bit quantity is taken from either the bottom or the top half of its source register. The other half of the second source register is ignored. The top 32 bits of the 48-bit product are written to the destination register. The bottom 16 bits of the 48-bit product are ignored. No overflow is possible during this instruction.

Encoding T1 ARMv6T2, ARMv7

SMULW<y><c> <Rd>, <Rn>, <Rm>

15	14	13	12	11	10	9	8	7	6	5	4	3	2	1	0	15	14	13	12	11	10	9	8	7	6	5	4	3	2	1	0
1	1	1	1	1	0	1	1	0	0	1	1	Rn				1	1	1	1	Rd				0	0	0	M	Rm			

d = UInt(Rd); n = UInt(Rn); m = UInt(Rm); m_high = (M == '1');
 if BadReg(d) || BadReg(n) || BadReg(m) then UNPREDICTABLE;

Encoding A1 ARMv5TE*, ARMv6*, ARMv7

SMULW<y><c> <Rd>, <Rn>, <Rm>

31	30	29	28	27	26	25	24	23	22	21	20	19	18	17	16	15	14	13	12	11	10	9	8	7	6	5	4	3	2	1	0
cond				0	0	0	1	0	0	1	0	Rd				SBZ	Rm				1	M	1	0	Rn						

d = UInt(Rd); n = UInt(Rn); m = UInt(Rm); m_high = (M == '1');
 if d == 15 || n == 15 || m == 15 then UNPREDICTABLE;

Assembler syntax

SMULW<y><c><q> {<Rd>}, <Rn>, <Rm>

where:

<y>	Specifies which half of the source register <Rm> is used as the second multiply operand. If <y> is B, then the bottom half (bits [15:0]) of <Rm> is used. If <y> is T, then the top half (bits [31:16]) of <Rm> is used.
<c><q>	See <i>Standard assembler syntax fields</i> on page A8-7.
<Rd>	The destination register.
<Rn>	The first operand register.
<Rm>	The source register whose bottom or top half (selected by <y>) is the second multiply operand.

Operation

```
if ConditionPassed() then
    EncodingSpecificOperations();
    operand2 = if m_high then R[m]<31:16> else R[m]<15:0>;
    product = SInt(R[n]) * SInt(operand2);
    R[d] = product<47:16>;
    // Signed overflow cannot occur
```

Exceptions

None.

A8.6.181 SMUSD

Signed Dual Multiply Subtract performs two signed 16×16 -bit multiplications. It subtracts one of the products from the other, and writes the result to the destination register.

Optionally, you can exchange the halfwords of the second operand before performing the arithmetic. This produces top \times bottom and bottom \times top multiplication.

Overflow cannot occur.

Encoding T1 ARMv6T2, ARMv7

SMUSD{X}<c> <Rd>, <Rn>, <Rm>

15	14	13	12	11	10	9	8	7	6	5	4	3	2	1	0	15	14	13	12	11	10	9	8	7	6	5	4	3	2	1	0
1	1	1	1	1	0	1	1	0	1	0	0	Rn			1	1	1	1	Rd			0	0	0	M	Rm					

```
d = UInt(Rd); n = UInt(Rn); m = UInt(Rm); m_swap = (M == '1');
if BadReg(d) || BadReg(n) || BadReg(m) then UNPREDICTABLE;
```

Encoding A1 ARMv6*, ARMv7

SMUSD{X}<c> <Rd>, <Rn>, <Rm>

31	30	29	28	27	26	25	24	23	22	21	20	19	18	17	16	15	14	13	12	11	10	9	8	7	6	5	4	3	2	1	0
cond		0	1	1	1	0	0	0	0	Rd			1	1	1	1	Rm			0	1	M	1	Rn							

```
d = UInt(Rd); n = UInt(Rn); m = UInt(Rm); m_swap = (M == '1');
if d == 15 || n == 15 || m == 15 then UNPREDICTABLE;
```

Assembler syntax

SMUSD{X}<C><Q> {<Rd>,<Rn>,<Rm>

where:

X	If X is present, the multiplications are bottom \times top and top \times bottom. If the X is omitted, the multiplications are bottom \times bottom and top \times top.
<C><Q>	See <i>Standard assembler syntax fields</i> on page A8-7.
<Rd>	The destination register.
<Rn>	The first operand register.
<Rm>	The second operand register.

Operation

```
if ConditionPassed() then
    EncodingSpecificOperations();
    operand2 = if m_swap then ROR(R[m],16) else R[m];
    product1 = SInt(R[n]<15:0>) * SInt(operand2<15:0>);
    product2 = SInt(R[n]<31:16>) * SInt(operand2<31:16>);
    result = product1 - product2;
    R[d] = result<31:0>;
    // Signed overflow cannot occur
```

Exceptions

None.

A8.6.182 SRS

Store Return State is a system instruction. For details see *SRS* on page B6-20.

A8.6.183 SSAT

Signed Saturate saturates an optionally-shifted signed value to a selectable signed range.

The Q flag is set if the operation saturates.

Encoding T1 ARMv6T2, ARMv7

SSAT<c> <Rd>, #<imm>, <Rn>{, <shift>}

15	14	13	12	11	10	9	8	7	6	5	4	3	2	1	0	15	14	13	12	11	10	9	8	7	6	5	4	3	2	1	0
1	1	1	1	0	(0)	1	1	0	0	sh	0	Rn				0	imm3			Rd			imm2		(0)	sat_imm					

```

if sh == '1' && (imm3:imm2) == '0000' then SEE SSAT16;
d = UInt(Rd); n = UInt(Rn); saturate_to = UInt(sat_imm)+1;
(shift_t, shift_n) = DecodeImmShift(sh:'0', imm3:imm2);
if BadReg(d) || BadReg(n) then UNPREDICTABLE;
    
```

Encoding A1 ARMv6*, ARMv7

SSAT<c> <Rd>, #<imm>, <Rn>{, <shift>}

31	30	29	28	27	26	25	24	23	22	21	20	19	18	17	16	15	14	13	12	11	10	9	8	7	6	5	4	3	2	1	0
cond		0	1	1	0	1	0	1	sat_imm				Rd			imm5			sh	0	1	Rn									

```

d = UInt(Rd); n = UInt(Rn); saturate_to = UInt(sat_imm)+1;
(shift_t, shift_n) = DecodeImmShift(sh:'0', imm5);
if d == 15 || n == 15 then UNPREDICTABLE;
    
```

Assembler syntax

SSAT<c><q> <Rd>, #<imm>, <Rn> {,<shift>}

where:

<c><q> See *Standard assembler syntax fields* on page A8-7.

<Rd> The destination register.

<imm> The bit position for saturation, in the range 1 to 32.

<Rn> The register that contains the value to be saturated.

<shift> The optional shift, encoded in the sh bit and five bits in imm3:imm2 for encoding T1 and imm5 for encoding A1. It must be one of:

omitted No shift. Encoded as sh = 0, five bits = 0b00000

LSL #<n> Left shift by <n> bits, with <n> in the range 1-31.
Encoded as sh = 0, five bits = <n>.

ASR #<n> Arithmetic right shift by <n> bits, with <n> in the range 1-31.
Encoded as sh = 1, five bits = <n>.

ASR #32 Arithmetic right shift by 32 bits, permitted only for encoding A1.
Encoded as sh = 1, imm5 = 0b00000.

Note

An assembler can permit ASR #0 or LSL #0 to mean the same thing as omitting the shift, but this is not standard UAL and must not be used for disassembly.

Operation

```
if ConditionPassed() then
    EncodingSpecificOperations();
    operand = Shift(R[n], shift_t, shift_n, APSR.C); // APSR.C ignored
    (result, sat) = SignedSatQ(SInt(operand), saturate_to);
    R[d] = SignExtend(result, 32);
    if sat then
        APSR.Q = '1';
```

Exceptions

None.

A8.6.184 SSAT16

Signed Saturate 16 saturates two signed 16-bit values to a selected signed range.

The Q flag is set if the operation saturates.

Encoding T1 ARMv6T2, ARMv7

SSAT16<c> <Rd>, #<imm>, <Rn>

15	14	13	12	11	10	9	8	7	6	5	4	3	2	1	0	15	14	13	12	11	10	9	8	7	6	5	4	3	2	1	0
1	1	1	1	0	(0)	1	1	0	0	1	0	Rn				0	0	0	0	Rd				0	0	(0)	(0)	sat_imm			

d = UInt(Rd); n = UInt(Rn); saturate_to = UInt(sat_imm)+1;
 if BadReg(d) || BadReg(n) then UNPREDICTABLE;

Encoding A1 ARMv6*, ARMv7

SSAT16<c> <Rd>, #<imm>, <Rn>

31	30	29	28	27	26	25	24	23	22	21	20	19	18	17	16	15	14	13	12	11	10	9	8	7	6	5	4	3	2	1	0
cond		0	1	1	0	1	0	1	0	sat_imm				Rd				(1)	(1)	(1)	(1)	0	0	1	1	Rn					

d = UInt(Rd); n = UInt(Rn); saturate_to = UInt(sat_imm)+1;
 if d == 15 || n == 15 then UNPREDICTABLE;

Assembler syntax

SSAT16<c><q> <Rd>, #<imm>, <Rn>

where:

<c><q> See *Standard assembler syntax fields* on page A8-7.

<Rd> The destination register.

<imm> The bit position for saturation, in the range 1 to 16.

<Rn> The register that contains the values to be saturated.

Operation

```
if ConditionPassed() then
    EncodingSpecificOperations();
    (result1, sat1) = SignedSatQ(SInt(R[n]<15:0>), saturate_to);
    (result2, sat2) = SignedSatQ(SInt(R[n]<31:16>), saturate_to);
    R[d]<15:0> = SignExtend(result1, 16);
    R[d]<31:16> = SignExtend(result2, 16);
    if sat1 || sat2 then
        APSR.Q = '1';
```

Exceptions

None.

A8.6.185 SSAX

Signed Subtract and Add with Exchange exchanges the two halfwords of the second operand, performs one 16-bit integer subtraction and one 16-bit addition, and writes the results to the destination register. It sets the APSR.GE bits according to the results.

Encoding T1 ARMv6T2, ARMv7

SSAX<c> <Rd>, <Rn>, <Rm>

15	14	13	12	11	10	9	8	7	6	5	4	3	2	1	0	15	14	13	12	11	10	9	8	7	6	5	4	3	2	1	0
1	1	1	1	1	0	1	0	1	1	1	0	Rn			1	1	1	1	Rd			0	0	0	0	Rm					

d = UInt(Rd); n = UInt(Rn); m = UInt(Rm);
 if BadReg(d) || BadReg(n) || BadReg(m) then UNPREDICTABLE;

Encoding A1 ARMv6*, ARMv7

SSAX<c> <Rd>, <Rn>, <Rm>

31	30	29	28	27	26	25	24	23	22	21	20	19	18	17	16	15	14	13	12	11	10	9	8	7	6	5	4	3	2	1	0
cond		0	1	1	0	0	0	0	1	Rn			Rd			(1)	(1)	(1)	(1)	0	1	0	1	Rm							

d = UInt(Rd); n = UInt(Rn); m = UInt(Rm);
 if d == 15 || n == 15 || m == 15 then UNPREDICTABLE;

Assembler syntax

SSAX<c><q> {<Rd>}, <Rn>, <Rm>

where:

<c><q> See *Standard assembler syntax fields* on page A8-7.

<Rd> The destination register.

<Rn> The first operand register.

<Rm> The second operand register.

The pre-UAL syntax SSUBADDX<c> is equivalent to SSAX<c>.

Operation

```
if ConditionPassed() then
    EncodingSpecificOperations();
    sum = SInt(R[n]<15:0>) + SInt(R[m]<31:16>);
    diff = SInt(R[n]<31:16>) - SInt(R[m]<15:0>);
    R[d]<15:0> = sum<15:0>;
    R[d]<31:16> = diff<15:0>;
    APSR.GE<1:0> = if sum >= 0 then '11' else '00';
    APSR.GE<3:2> = if diff >= 0 then '11' else '00';
```

Exceptions

None.

A8.6.186 SSUB16

Signed Subtract 16 performs two 16-bit signed integer subtractions, and writes the results to the destination register. It sets the APSR.GE bits according to the results of the subtractions.

Encoding T1 ARMv6T2, ARMv7

SSUB16<c> <Rd>, <Rn>, <Rm>

15	14	13	12	11	10	9	8	7	6	5	4	3	2	1	0	15	14	13	12	11	10	9	8	7	6	5	4	3	2	1	0
1	1	1	1	1	0	1	0	1	1	0	1	Rn			1	1	1	1	Rd			0	0	0	0	Rm					

d = UInt(Rd); n = UInt(Rn); m = UInt(Rm);
 if BadReg(d) || BadReg(n) || BadReg(m) then UNPREDICTABLE;

Encoding A1 ARMv6*, ARMv7

SSUB16<c> <Rd>, <Rn>, <Rm>

31	30	29	28	27	26	25	24	23	22	21	20	19	18	17	16	15	14	13	12	11	10	9	8	7	6	5	4	3	2	1	0
cond		0	1	1	0	0	0	0	1	Rn			Rd			(1)	(1)	(1)	(1)	0			1	1	1	Rm					

d = UInt(Rd); n = UInt(Rn); m = UInt(Rm);
 if d == 15 || n == 15 || m == 15 then UNPREDICTABLE;

Assembler syntax

SSUB16<c><q> {<Rd>}, <Rn>, <Rm>

where:

<c><q> See *Standard assembler syntax fields* on page A8-7.

<Rd> The destination register.

<Rn> The first operand register.

<Rm> The second operand register.

Operation

```
if ConditionPassed() then
    EncodingSpecificOperations();
    diff1 = SInt(R[n]<15:0>) - SInt(R[m]<15:0>);
    diff2 = SInt(R[n]<31:16>) - SInt(R[m]<31:16>);
    R[d]<15:0> = diff1<15:0>;
    R[d]<31:16> = diff2<15:0>;
    APSR.GE<1:0> = if diff1 >= 0 then '11' else '00';
    APSR.GE<3:2> = if diff2 >= 0 then '11' else '00';
```

Exceptions

None.

A8.6.187 SSUB8

Signed Subtract 8 performs four 8-bit signed integer subtractions, and writes the results to the destination register. It sets the APSR.GE bits according to the results of the subtractions.

Encoding T1 ARMv6T2, ARMv7

SSUB8<c> <Rd>, <Rn>, <Rm>

15	14	13	12	11	10	9	8	7	6	5	4	3	2	1	0	15	14	13	12	11	10	9	8	7	6	5	4	3	2	1	0
1	1	1	1	1	0	1	0	1	1	0	0	Rn			1	1	1	1	Rd			0	0	0	0	Rm					

d = UInt(Rd); n = UInt(Rn); m = UInt(Rm);
 if BadReg(d) || BadReg(n) || BadReg(m) then UNPREDICTABLE;

Encoding A1 ARMv6*, ARMv7

SSUB8<c> <Rd>, <Rn>, <Rm>

31	30	29	28	27	26	25	24	23	22	21	20	19	18	17	16	15	14	13	12	11	10	9	8	7	6	5	4	3	2	1	0
cond		0	1	1	0	0	0	0	1	Rn			Rd			(1)	(1)	(1)	(1)	1			1	1	1	1	Rm				

d = UInt(Rd); n = UInt(Rn); m = UInt(Rm);
 if d == 15 || n == 15 || m == 15 then UNPREDICTABLE;

Assembler syntax

SSUB8<c><q> {<Rd>}, <Rn>, <Rm>

where:

<c><q> See *Standard assembler syntax fields* on page A8-7.

<Rd> The destination register.

<Rn> The first operand register.

<Rm> The second operand register.

Operation

```

if ConditionPassed() then
    EncodingSpecificOperations();
    diff1 = SInt(R[n]<7:0>) - SInt(R[m]<7:0>);
    diff2 = SInt(R[n]<15:8>) - SInt(R[m]<15:8>);
    diff3 = SInt(R[n]<23:16>) - SInt(R[m]<23:16>);
    diff4 = SInt(R[n]<31:24>) - SInt(R[m]<31:24>);
    R[d]<7:0> = diff1<7:0>;
    R[d]<15:8> = diff2<7:0>;
    R[d]<23:16> = diff3<7:0>;
    R[d]<31:24> = diff4<7:0>;
    APSR.GE<0> = if diff1 >= 0 then '1' else '0';
    APSR.GE<1> = if diff2 >= 0 then '1' else '0';
    APSR.GE<2> = if diff3 >= 0 then '1' else '0';
    APSR.GE<3> = if diff4 >= 0 then '1' else '0';

```

Exceptions

None.

A8.6.188 STC, STC2

Store Coprocessor stores data from a coprocessor to a sequence of consecutive memory addresses. If no coprocessor can execute the instruction, an Undefined Instruction exception is generated.

This is a generic coprocessor instruction. Some of the fields have no functionality defined by the architecture and are free for use by the coprocessor instruction set designer. These fields are the D bit, the CRd field, and in the Unindexed addressing mode only, the imm8 field.

For more information about the coprocessors see *Coprocessor support* on page A2-68.

Encoding T1 / A1 ARMv6T2, ARMv7 for encoding T1
 ARMv4*, ARMv5T*, ARMv6*, ARMv7 for encoding A1

STC{L}<c> <coproc>, <CRd>, [<Rn>, #+/-<imm>]{!}

STC{L}<c> <coproc>, <CRd>, [<Rn>], #+/-<imm>

STC{L}<c> <coproc>, <CRd>, [<Rn>], <option>

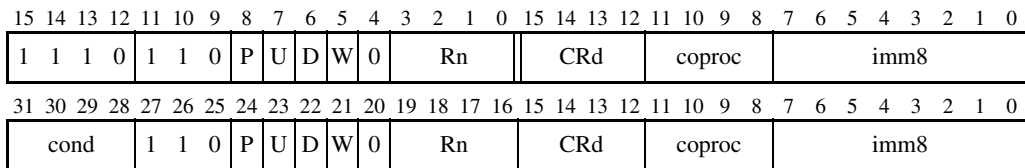

```

if P == '0' && U == '0' && D == '0' && W == '0' then UNDEFINED;
if P == '0' && U == '0' && D == '1' && W == '0' then SEE MCCR, MCRR2;
if coproc == '101x' then SEE "Advanced SIMD and VFP";
n = UInt(Rn); cp = UInt(coproc); imm32 = ZeroExtend(imm8:'00', 32);
index = (P == '1'); add = (U == '1'); wback = (W == '1');
if n == 15 && (wback || CurrentInstrSet() != InstrSet_ARM) then UNPREDICTABLE;
    
```

Encoding T2 / A2 ARMv6T2, ARMv7 for encoding T2
 ARMv5T*, ARMv6*, ARMv7 for encoding A2

STC2{L}<c> <coproc>, <CRd>, [<Rn>, #+/-<imm>]{!}

STC2{L}<c> <coproc>, <CRd>, [<Rn>], #+/-<imm>

STC2{L}<c> <coproc>, <CRd>, [<Rn>], <option>

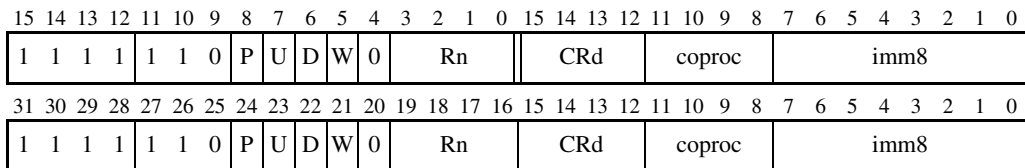

```

if P == '0' && U == '0' && D == '0' && W == '0' then UNDEFINED;
if P == '0' && U == '0' && D == '1' && W == '0' then SEE MCCR, MCRR2;
n = UInt(Rn); cp = UInt(coproc); imm32 = ZeroExtend(imm8:'00', 32);
index = (P == '1'); add = (U == '1'); wback = (W == '1');
if n == 15 && (wback || CurrentInstrSet() != InstrSet_ARM) then UNPREDICTABLE;
    
```

Advanced SIMD and VFP See *Extension register load/store instructions* on page A7-26

Assembler syntax

STC{2}{L}<C><Q>	<coproc>, <CRd>, [<Rn>{, #+/-<imm>}]	Offset. P = 1, W = 0.
STC{2}{L}<C><Q>	<coproc>, <CRd>, [<Rn>, #+/-<imm>!]	Pre-indexed. P = 1, W = 1.
STC{2}{L}<C><Q>	<coproc>, <CRd>, [<Rn>], #+/-<imm>	Post-indexed. P = 0, W = 1.
STC{2}{L}<C><Q>	<coproc>, <CRd>, [<Rn>], <option>	Unindexed. P = 0, W = 0, U = 1.

where:

2	If specified, selects encoding T2 / A2. If omitted, selects encoding T1 / A1.
L	If specified, selects the D == 1 form of the encoding. If omitted, selects the D == 0 form.
<C><Q>	See <i>Standard assembler syntax fields</i> on page A8-7. An ARM STC2 instruction must be unconditional.
<coproc>	The name of the coprocessor. The standard generic coprocessor names are p0, p1, ..., p15.
<CRd>	The coprocessor source register.
<Rn>	The base register. The SP can be used. In the ARM instruction set, for offset and unindexed addressing only, the PC can be used. However, use of the PC is deprecated.
+/-	Is + or omitted if the immediate offset is to be added to the base register value (add == TRUE), or – if it is to be subtracted (add == FALSE). #0 and #-0 generate different instructions.
<imm>	The immediate offset used to form the address. Values are multiples of 4 in the range 0-1020. For the offset addressing syntax, <imm> can be omitted, meaning an offset of +0.
<option>	A coprocessor option. An integer in the range 0-255 enclosed in { }. Encoded in imm8.

The pre-UAL syntax STC<C>L is equivalent to STCL<C>.

Operation

```

if ConditionPassed() then
    EncodingSpecificOperations();
    if !Coprocc_Accepted(cp, ThisInstr()) then
        GenerateCoproccorException();
    else
        NullCheckIfThumbEE(n);
        offset_addr = if add then (R[n] + imm32) else (R[n] - imm32);
        address = if index then offset_addr else R[n];
        repeat
            MemA[address,4] = Coproc_GetWordToStore(cp, ThisInstr()); address = address + 4;
        until Coproc_DoneStoring(cp, ThisInstr());
        if wback then R[n] = offset_addr;

```

Exceptions

Undefined Instruction, Data Abort.

A8.6.189 STM / STMIA / STMEA

Store Multiple Increment After (Store Multiple Empty Ascending) stores multiple registers to consecutive memory locations using an address from a base register. The consecutive memory locations start at this address, and the address just above the last of those locations can optionally be written back to the base register.

For details of related system instructions see *STM (user registers)* on page B6-22.

Encoding T1 ARMv4T, ARMv5T*, ARMv6*, ARMv7 (not in ThumbEE)

STM<c> <Rn>!,<registers>

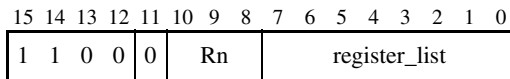

```
n = UInt(Rn); registers = '0000000':register_list; wback = TRUE;
if BitCount(registers) < 1 then UNPREDICTABLE;
```

Encoding T2 ARMv6T2, ARMv7

STM<c>.W <Rn>{!},<registers>

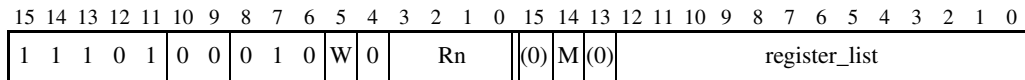

```
n = UInt(Rn); registers = '0':M:'0':register_list; wback = (W == '1');
if n == 15 || BitCount(registers) < 2 then UNPREDICTABLE;
if wback && registers<n> == '1' then UNPREDICTABLE;
```

Encoding A1 ARMv4*, ARMv5T*, ARMv6*, ARMv7

STM<c> <Rn>{!},<registers>

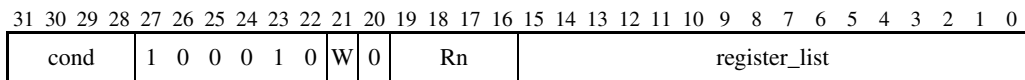

```
n = UInt(Rn); registers = register_list; wback = (W == '1');
if n == 15 || BitCount(registers) < 1 then UNPREDICTABLE;
```

Assembler syntax

STM<c><q> <Rn>{!}, <registers>

where:

<c><q> See *Standard assembler syntax fields* on page A8-7.

<Rn> The base register. The SP can be used.

! Causes the instruction to write a modified value back to <Rn>. Encoded as W = 1.

If ! is omitted, the instruction does not change <Rn> in this way. Encoded as W = 0.

<registers> Is a list of one or more registers to be stored, separated by commas and surrounded by { and }. The lowest-numbered register is stored to the lowest memory address, through to the highest-numbered register to the highest memory address.

Encoding T2 does not support a list containing only one register. If an STM instruction with just one register <Rt> in the list is assembled to Thumb and encoding T1 is not available, it is assembled to the equivalent STR<c><q> <Rt>, [<Rn>]{, #4} instruction.

The SP and PC can be in the list in ARM code, but not in Thumb code. However, ARM instructions that include the SP or the PC in the list are deprecated.

Encoding T2 is not available for instructions with the base register in the list and ! specified, and the use of such instructions is deprecated. If the base register is not the lowest-numbered register in the list, such an instruction stores an UNKNOWN value for the base register.

STMEA and STMIA are pseudo-instructions for STM. STMEA refers to its use for pushing data onto Empty Ascending stacks.

The pre-UAL syntaxes STM<c>IA and STM<c>EA are equivalent to STM<c>.

Operation

```

if ConditionPassed() then
    EncodingSpecificOperations(); NullCheckIfThumbEE(n);
    address = R[n];
    for i = 0 to 14
        if registers<i> == '1' then
            if i == n && wback && i != LowestSetBit(registers) then
                MemA[address,4] = bits(32) UNKNOWN; // Only possible for encodings T1 and A1
            else
                MemA[address,4] = R[i];
                address = address + 4;
        if registers<15> == '1' then // Only possible for encoding A1
            MemA[address,4] = PCStoreValue();
        if wback then R[n] = R[n] + 4*BitCount(registers);

```

Exceptions

Data Abort.

A8.6.190 STMDA / STMED

Store Multiple Decrement After (Store Multiple Empty Descending) stores multiple registers to consecutive memory locations using an address from a base register. The consecutive memory locations end at this address, and the address just below the lowest of those locations can optionally be written back to the base register.

For details of related system instructions see *STM (user registers)* on page B6-22.

Encoding A1 ARMv4*, ARMv5T*, ARMv6*, ARMv7

STMDA<c> <Rn>{!}, <registers>

31	30	29	28	27	26	25	24	23	22	21	20	19	18	17	16	15	14	13	12	11	10	9	8	7	6	5	4	3	2	1	0
cond		1	0	0	0	0	0	W	0	Rn				register_list																	

```
n = UInt(Rn); registers = register_list; wback = (W == '1');
if n == 15 || BitCount(registers) < 1 then UNPREDICTABLE;
```

Assembler syntax

STMDA<c><q> <Rn>{!}, <registers>

where:

<c><q> See *Standard assembler syntax fields* on page A8-7.

<Rn> The base register. The SP can be used.

! Causes the instruction to write a modified value back to <Rn>. Encoded as W = 1.
If ! is omitted, the instruction does not change <Rn> in this way. Encoded as W = 0.

<registers> Is a list of one or more registers to be stored, separated by commas and surrounded by { and }. The lowest-numbered register is stored to the lowest memory address, through to the highest-numbered register to the highest memory address.

The SP and PC can be in the list. However, instructions that include the SP or the PC in the list are deprecated.

The use of instructions with the base register in the list and ! specified is deprecated. If the base register is not the lowest-numbered register in the list, such an instruction stores an UNKNOWN value for the base register.

STMED is a pseudo-instruction for STMDA, referring to its use for pushing data onto Empty Descending stacks.

The pre-UAL syntaxes STM<c>DA and STM<c>ED are equivalent to STMDA<c>.

Operation

```

if ConditionPassed() then
    EncodingSpecificOperations();
    address = R[n] - 4*BitCount(registers) + 4;
    for i = 0 to 14
        if registers<i> == '1' then
            if i == n && wback && i != LowestSetBit(registers) then
                MemA[address,4] = bits(32) UNKNOWN;
            else
                MemA[address,4] = R[i];
                address = address + 4;
    if registers<15> == '1' then
        MemA[address,4] = PCStoreValue();
    if wback then R[n] = R[n] - 4*BitCount(registers);

```

Exceptions

Data Abort.

A8.6.191 STMDB / STMFD

Store Multiple Decrement Before (Store Multiple Full Descending) stores multiple registers to consecutive memory locations using an address from a base register. The consecutive memory locations end just below this address, and the address of the first of those locations can optionally be written back to the base register.

For details of related system instructions see *STM (user registers)* on page B6-22.

Encoding T1 ARMv6T2, ARMv7

STMDB<c> <Rn>{!}, <registers>

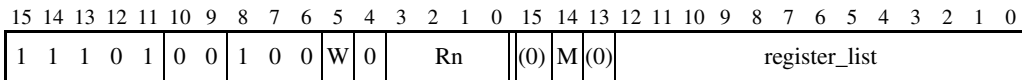

```
if W == '1' && Rn == '1101' then SEE PUSH;
n = UInt(Rn); registers = '0':M:'0':register_list; wback = (W == '1');
if n == 15 || BitCount(registers) < 2 then UNPREDICTABLE;
if wback && registers<n> == '1' then UNPREDICTABLE;
```

Encoding A1 ARMv4*, ARMv5T*, ARMv6*, ARMv7

STMDB<c> <Rn>{!}, <registers>

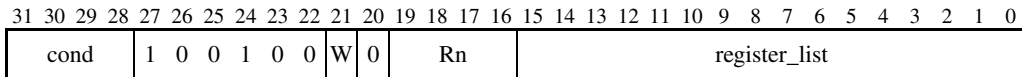

```
if W == '1' && Rn == '1101' && BitCount(register_list) >= 2 then SEE PUSH;
n = UInt(Rn); registers = register_list; wback = (W == '1');
if n == 15 || BitCount(registers) < 1 then UNPREDICTABLE;
```

Assembler syntax

STMDB<c><q> <Rn>{!}, <registers>

where:

<c><q> See *Standard assembler syntax fields* on page A8-7.

<Rn> The base register. The SP can be used. If it is the SP and ! is specified, it is treated as described in *PUSH* on page A8-248.

! Causes the instruction to write a modified value back to <Rn>. Encoded as W = 1.
If ! is omitted, the instruction does not change <Rn> in this way. Encoded as W = 0.

<registers> Is a list of one or more registers to be stored, separated by commas and surrounded by { and }. The lowest-numbered register is stored to the lowest memory address, through to the highest-numbered register to the highest memory address.

Encoding T1 does not support a list containing only one register. If an STMDB instruction with just one register <Rt> in the list is assembled to Thumb, it is assembled to the equivalent STR<c><q> <Rt>, [<Rn>, #-4]{!} instruction.

The SP and PC can be in the list in ARM code, but not in Thumb code. However, ARM instructions that include the SP or the PC in the list are deprecated.

Instructions with the base register in the list and ! specified are only available in the ARM instruction set, and the use of such instructions is deprecated. If the base register is not the lowest-numbered register in the list, such an instruction stores an UNKNOWN value for the base register.

STMTD is a pseudo-instruction for STMTDB, referring to its use for pushing data onto Full Descending stacks.

The pre-UAL syntaxes STM<c>DB and STM<c>FD are equivalent to STMTDB<c>.

Operation

```

if ConditionPassed() then
    EncodingSpecificOperations(); NullCheckIfThumbEE(n);
    address = R[n] - 4*BitCount(registers);
    for i = 0 to 14
        if registers<i> == '1' then
            if i == n && wback && i != LowestSetBit(registers) then
                MemA[address,4] = bits(32) UNKNOWN; // Only possible for encoding A1
            else
                MemA[address,4] = R[i];
                address = address + 4;
    if registers<15> == '1' then // Only possible for encoding A1
        MemA[address,4] = PCStoreValue();
    if wback then R[n] = R[n] - 4*BitCount(registers);

```

Exceptions

Data Abort.

A8.6.192 STMIB / STMFA

Store Multiple Increment Before (Store Multiple Full Ascending) stores multiple registers to consecutive memory locations using an address from a base register. The consecutive memory locations start just above this address, and the address of the last of those locations can optionally be written back to the base register.

For details of related system instructions see *STM (user registers)* on page B6-22.

Encoding A1 ARMv4*, ARMv5T*, ARMv6*, ARMv7

STMIB<c> <Rn>{!}, <registers>

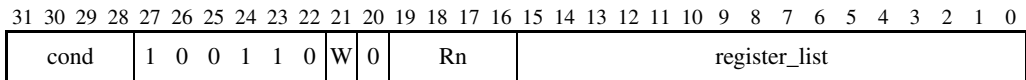

```
n = UInt(Rn); registers = register_list; wback = (W == '1');
if n == 15 || BitCount(registers) < 1 then UNPREDICTABLE;
```

Assembler syntax

STMIB<c><q> <Rn>{!}, <registers>

where:

<c><q> See *Standard assembler syntax fields* on page A8-7.

<Rn> The base register. The SP can be used.

! Causes the instruction to write a modified value back to <Rn>. Encoded as W = 1.
If ! is omitted, the instruction does not change <Rn> in this way. Encoded as W = 0.

<registers> Is a list of one or more registers to be stored, separated by commas and surrounded by { and }. The lowest-numbered register is stored to the lowest memory address, through to the highest-numbered register to the highest memory address.

The SP and PC can be in the list. However, instructions that include the SP or the PC in the list are deprecated.

The use of instructions with the base register in the list and ! specified is deprecated. If the base register is not the lowest-numbered register in the list, such an instruction stores an UNKNOWN value for the base register.

STMFA is a pseudo-instruction for STMIB, referring to its use for pushing data onto Full Ascending stacks.

The pre-UAL syntax STM<c>IB and STM<c>FA are equivalent to STMIB<c>.

Operation

```

if ConditionPassed() then
    EncodingSpecificOperations();
    address = R[n] + 4;
    for i = 0 to 14
        if registers<i> == '1' then
            if i == n && wback && i != LowestSetBit(registers) then
                MemA[address,4] = bits(32) UNKNOWN;
            else
                MemA[address,4] = R[i];
            address = address + 4;
    if registers<15> == '1' then
        MemA[address,4] = PCStoreValue();
    if wback then R[n] = R[n] + 4*BitCount(registers);

```

Exceptions

Data Abort.

A8.6.193 STR (immediate, Thumb)

Store Register (immediate) calculates an address from a base register value and an immediate offset, and stores a word from a register to memory. It can use offset, post-indexed, or pre-indexed addressing. For information about memory accesses see *Memory accesses* on page A8-13.

Encoding T1 ARMv4T, ARMv5T*, ARMv6*, ARMv7

STR<C> <Rt>, [<Rn>{, #<imm>}]

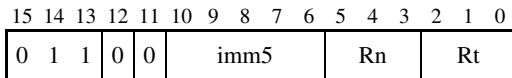

t = UInt(Rt); n = UInt(Rn); imm32 = ZeroExtend(imm5:'00', 32);
 index = TRUE; add = TRUE; wback = FALSE;

Encoding T2 ARMv4T, ARMv5T*, ARMv6*, ARMv7

STR<C> <Rt>, [SP, #<imm>]

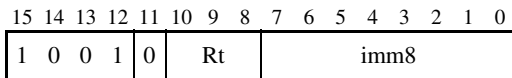

t = UInt(Rt); n = 13; imm32 = ZeroExtend(imm8:'00', 32);
 index = TRUE; add = TRUE; wback = FALSE;

Encoding T3 ARMv6T2, ARMv7

STR<C>.W <Rt>, [<Rn>, #<imm12>]

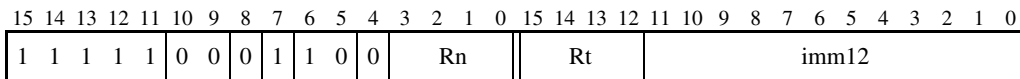

if Rn == '1111' then UNDEFINED;
 t = UInt(Rt); n = UInt(Rn); imm32 = ZeroExtend(imm12, 32);
 index = TRUE; add = TRUE; wback = FALSE;
 if t == 15 then UNPREDICTABLE;

Encoding T4 ARMv6T2, ARMv7

STR<C> <Rt>, [<Rn>, #-<imm8>]

STR<C> <Rt>, [<Rn>], #+/-<imm8>

STR<C> <Rt>, [<Rn>, #+/-<imm8>]!

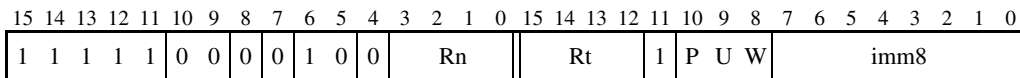

if P == '1' && U == '1' && W == '0' then SEE STRT;
 if Rn == '1101' && P == '1' && U == '0' && W == '1' && imm8 == '00000100' then SEE PUSH;
 if Rn == '1111' || (P == '0' && W == '0') then UNDEFINED;
 t = UInt(Rt); n = UInt(Rn); imm32 = ZeroExtend(imm8, 32);
 index = (P == '1'); add = (U == '1'); wback = (W == '1');
 if t == 15 || (wback && n == t) then UNPREDICTABLE;

Assembler syntax

STR<C><Q> <Rt>, [<Rn> {, #+/-<imm>}]	Offset: index==TRUE, wback==FALSE
STR<C><Q> <Rt>, [<Rn>, #+/-<imm>]!	Pre-indexed: index==TRUE, wback==TRUE
STR<C><Q> <Rt>, [<Rn>], #+/-<imm>	Post-indexed: index==FALSE, wback==TRUE

where:

<C><Q>	See <i>Standard assembler syntax fields</i> on page A8-7.
<Rt>	The source register. The SP can be used.
<Rn>	The base register. The SP can be used.
+/-	Is + or omitted if the immediate offset is to be added to the base register value (add == TRUE), or – if it is to be subtracted (add == FALSE). #0 and #-0 generate different instructions.
<imm>	The immediate offset used to form the address. Values are: <ul style="list-style-type: none"> Encoding T1 multiples of 4 in the range 0-124 Encoding T2 multiples of 4 in the range 0-1020 Encoding T3 any value in the range 0-4095 Encoding T4 any value in the range 0-255. For the offset addressing syntax, <imm> can be omitted, meaning an offset of 0.

Operation

```

if ConditionPassed() then
    EncodingSpecificOperations(); NullCheckIfThumbEE(n);
    offset_addr = if add then (R[n] + imm32) else (R[n] - imm32);
    address = if index then offset_addr else R[n];
    if UnalignedSupport() || address<1:0> == '00' then
        MemU[address,4] = R[t];
    else // Can only occur before ARMv7
        MemU[address,4] = bits(32) UNKNOWN;
    if wback then R[n] = offset_addr;

```

Exceptions

Data Abort.

ThumbEE instruction

ThumbEE has an additional STR (immediate) encoding. For details see *STR (immediate)* on page A9-21.

A8.6.194 STR (immediate, ARM)

Store Register (immediate) calculates an address from a base register value and an immediate offset, and stores a word from a register to memory. It can use offset, post-indexed, or pre-indexed addressing. For information about memory accesses see *Memory accesses* on page A8-13.

Encoding A1 ARMv4*, ARMv5T*, ARMv6*, ARMv7

STR<C> <Rt>, [<Rn>{, #+/-<imm12>}]

STR<C> <Rt>, [<Rn>], #+/-<imm12>

STR<C> <Rt>, [<Rn>, #+/-<imm12>]!

	31	30	29	28	27	26	25	24	23	22	21	20	19	18	17	16	15	14	13	12	11	10	9	8	7	6	5	4	3	2	1	0
	cond			0	1	0	P	U	0	W	0	Rn			Rt			imm12														

```

if P == '0' && W == '1' then SEE STRT;
if Rn == '1101' && P == '1' && U == '0' && W == '1' && imm12 == '00000000100' then SEE PUSH;
t = UInt(Rt); n = UInt(Rn); imm32 = ZeroExtend(imm12, 32);
index = (P == '1'); add = (U == '1'); wback = (P == '0') || (W == '1');
if wback && (n == 15 || n == t) then UNPREDICTABLE;
    
```

Assembler syntax

STR<c><q> <Rt>, [<Rn> {, #+/-<imm>}]	Offset: index==TRUE, wback==FALSE
STR<c><q> <Rt>, [<Rn>, #+/-<imm>]!	Pre-indexed: index==TRUE, wback==TRUE
STR<c><q> <Rt>, [<Rn>], #+/-<imm>	Post-indexed: index==FALSE, wback==TRUE

where:

<c><q>	See <i>Standard assembler syntax fields</i> on page A8-7.
<Rt>	The source register. The SP or the PC can be used. However, use of the PC is deprecated.
<Rn>	The base register. The SP can be used. For offset addressing only, the PC can be used. However, use of the PC is deprecated.
+/-	Is + or omitted if the immediate offset is to be added to the base register value (add == TRUE), or – if it is to be subtracted (add == FALSE). #0 and #-0 generate different instructions.
<imm>	The immediate offset used to form the address. Any value in the range 0-4095 is permitted. For the offset addressing syntax, <imm> can be omitted, meaning an offset of 0.

Operation

```

if ConditionPassed() then
    EncodingSpecificOperations();
    offset_addr = if add then (R[n] + imm32) else (R[n] - imm32);
    address = if index then offset_addr else R[n];
    MemU[address,4] = if t == 15 then PCStoreValue() else R[t];
    if wback then R[n] = offset_addr;

```

Exceptions

Data Abort.

A8.6.195 STR (register)

Store Register (register) calculates an address from a base register value and an offset register value, stores a word from a register to memory. The offset register value can optionally be shifted. For information about memory accesses see *Memory accesses* on page A8-13.

Encoding T1 ARMv4T, ARMv5T*, ARMv6*, ARMv7

STR<c> <Rt>, [<Rn>, <Rm>]

15	14	13	12	11	10	9	8	7	6	5	4	3	2	1	0
0	1	0	1	0	0	0	Rm			Rn			Rt		

```
if CurrentInstrSet() == InstrSet_ThumbEE then SEE "Modified operation in ThumbEE";
t = UInt(Rt); n = UInt(Rn); m = UInt(Rm);
index = TRUE; add = TRUE; wback = FALSE;
(shift_t, shift_n) = (SRTYPE_LSL, 0);
```

Encoding T2 ARMv6T2, ARMv7

STR<c>.W <Rt>, [<Rn>, <Rm>{, LSL #<imm2>}]

15	14	13	12	11	10	9	8	7	6	5	4	3	2	1	0	15	14	13	12	11	10	9	8	7	6	5	4	3	2	1	0
1	1	1	1	1	0	0	0	0	1	0	0	Rn			Rt			0	0	0	0	0	0	imm2	Rm						

```
if Rn == '1111' then UNDEFINED;
t = UInt(Rt); n = UInt(Rn); m = UInt(Rm);
index = TRUE; add = TRUE; wback = FALSE;
(shift_t, shift_n) = (SRTYPE_LSL, UInt(imm2));
if t == 15 || BadReg(m) then UNPREDICTABLE;
```

Encoding A1 ARMv4*, ARMv5T*, ARMv6*, ARMv7

STR<c> <Rt>, [<Rn>, +/-<Rm>{, <shift>}{!}]

STR<c> <Rt>, [<Rn>], +/-<Rm>{, <shift>}

31	30	29	28	27	26	25	24	23	22	21	20	19	18	17	16	15	14	13	12	11	10	9	8	7	6	5	4	3	2	1	0
cond		0	1	1	P	U	0	W	0	Rn			Rt			imm5			type	0	Rm										

```
if P == '0' && W == '1' then SEE STRT;
t = UInt(Rt); n = UInt(Rn); m = UInt(Rm);
index = (P == '1'); add = (U == '1'); wback = (P == '0') || (W == '1');
(shift_t, shift_n) = DecodeImmShift(type, imm5);
if m == 15 then UNPREDICTABLE;
if wback && (n == 15 || n == t) then UNPREDICTABLE;
if ArchVersion() < 6 && wback && m == n then UNPREDICTABLE;
```

Modified operation in ThumbEE

See *STR (register)* on page A9-12

Assembler syntax

STR<C><Q> <Rt>, [<Rn>, <Rm>{, <shift>}]	Offset: index==TRUE, wback==FALSE
STR<C><Q> <Rt>, [<Rn>, <Rm>{, <shift>}]!	Pre-indexed: index==TRUE, wback==TRUE
STR<C><Q> <Rt>, [<Rn>], <Rm>{, <shift>}	Post-indexed: index==FALSE, wback==TRUE

where:

<C><Q>	See <i>Standard assembler syntax fields</i> on page A8-7.
<Rt>	The source register. The SP can be used. In the ARM instruction set, the PC can be used. However, use of the PC is deprecated.
<Rn>	The base register. The SP can be used. In the ARM instruction set, for offset addressing only, the PC can be used. However, use of the PC is deprecated.
+/-	Is + or omitted if the optionally shifted value of <Rm> is to be added to the base register value (add == TRUE), or – if it is to be subtracted (permitted in ARM code only, add == FALSE).
<Rm>	Contains the offset that is optionally shifted and added to the value of <Rn> to form the address.
<shift>	The shift to apply to the value read from <Rm>. If present, encoding T1 is not permitted. If absent, no shift is applied and all encodings are permitted. For encoding T2, <shift> can only be omitted, encoded as imm2 = 0b00, or LSL #<imm> with <imm> = 1, 2, or 3, and <imm> encoded in imm2. For encoding A1, see <i>Shifts applied to a register</i> on page A8-10.

Operation

```

if ConditionPassed() then
    EncodingSpecificOperations(); NullCheckIfThumbEE(n);
    offset = Shift(R[m], shift_t, shift_n, APSR.C);
    offset_addr = if add then (R[n] + offset) else (R[n] - offset);
    address = if index then offset_addr else R[n];
    if t == 15 then // Only possible for encoding A1
        data = PCStoreValue();
    else
        data = R[t];
    if UnalignedSupport() || address<1:0> == '00' || CurrentInstrSet() == InstrSet_ARM then
        MemU[address,4] = data;
    else // Can only occur before ARMv7
        MemU[address,4] = bits(32) UNKNOWN;
    if wback then R[n] = offset_addr;

```

Exceptions

Data Abort.

A8.6.196 STRB (immediate, Thumb)

Store Register Byte (immediate) calculates an address from a base register value and an immediate offset, and stores a byte from a register to memory. It can use offset, post-indexed, or pre-indexed addressing. For information about memory accesses see *Memory accesses* on page A8-13.

Encoding T1 ARMv4T, ARMv5T*, ARMv6*, ARMv7

STRB<c> <Rt>, [<Rn>, #<imm5>]

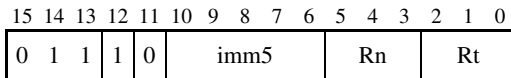

t = UInt(Rt); n = UInt(Rn); imm32 = ZeroExtend(imm5, 32);
 index = TRUE; add = TRUE; wback = FALSE;

Encoding T2 ARMv6T2, ARMv7

STRB<c>.W <Rt>, [<Rn>, #<imm12>]

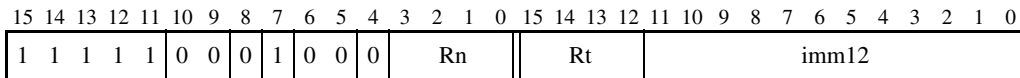

if Rn == '1111' then UNDEFINED;
 t = UInt(Rt); n = UInt(Rn); imm32 = ZeroExtend(imm12, 32);
 index = TRUE; add = TRUE; wback = FALSE;
 if BadReg(t) then UNPREDICTABLE;

Encoding T3 ARMv6T2, ARMv7

STRB<c> <Rt>, [<Rn>, #-<imm8>]

STRB<c> <Rt>, [<Rn>], #+/-<imm8>

STRB<c> <Rt>, [<Rn>, #+/-<imm8>]!

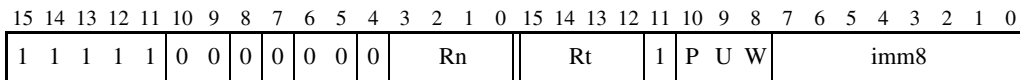

if P == '1' && U == '1' && W == '0' then SEE STRBT;
 if Rn == '1111' || (P == '0' && W == '0') then UNDEFINED;
 t = UInt(Rt); n = UInt(Rn); imm32 = ZeroExtend(imm8, 32);
 index = (P == '1'); add = (U == '1'); wback = (W == '1');
 if BadReg(t) || (wback && n == t) then UNPREDICTABLE;

Assembler syntax

STRB<c><q> <Rt>, [<Rn> {, #+/-<imm>}]	Offset: index==TRUE, wback==FALSE
STRB<c><q> <Rt>, [<Rn>, #+/-<imm>]!	Pre-indexed: index==TRUE, wback==TRUE
STRB<c><q> <Rt>, [<Rn>], #+/-<imm>	Post-indexed: index==FALSE, wback==TRUE

where:

<c><q>	See <i>Standard assembler syntax fields</i> on page A8-7.
<Rt>	The source register.
<Rn>	The base register. The SP can be used.
+/-	Is + or omitted if the immediate offset is to be added to the base register value (add == TRUE), or – if it is to be subtracted (add == FALSE). #0 and #-0 generate different instructions.
<imm>	The immediate offset used to form the address. Values are: <ul style="list-style-type: none"> Encoding T1 any value in the range 0-31 Encoding T2 any value in the range 0-4095 Encoding T3 any value in the range 0-255. For the offset addressing syntax, <imm> can be omitted, meaning an offset of 0.

The pre-UAL syntax STR<c>B is equivalent to STRB<c>.

Operation

```

if ConditionPassed() then
    EncodingSpecificOperations(); NullCheckIfThumbEE(n);
    offset_addr = if add then (R[n] + imm32) else (R[n] - imm32);
    address = if index then offset_addr else R[n];
    MemU[address,1] = R[t]<7:0>;
    if wback then R[n] = offset_addr;

```

Exceptions

Data Abort.

A8.6.197 STRB (immediate, ARM)

Store Register Byte (immediate) calculates an address from a base register value and an immediate offset, and stores a byte from a register to memory. It can use offset, post-indexed, or pre-indexed addressing. For information about memory accesses see *Memory accesses* on page A8-13.

Encoding A1 ARMv4*, ARMv5T*, ARMv6*, ARMv7

STRB<c> <Rt>, [<Rn>{, #+/-<imm12>}]

STRB<c> <Rt>, [<Rn>], #+/-<imm12>

STRB<c> <Rt>, [<Rn>, #+/-<imm12>]!

31	30	29	28	27	26	25	24	23	22	21	20	19	18	17	16	15	14	13	12	11	10	9	8	7	6	5	4	3	2	1	0
cond		0	1	0	P	U	1	W	0	Rn				Rt				imm12													

if P == '0' && W == '1' then SEE STRBT;

t = UInt(Rt); n = UInt(Rn); imm32 = ZeroExtend(imm12, 32);

index = (P == '1'); add = (U == '1'); wback = (P == '0') || (W == '1');

if t == 15 then UNPREDICTABLE;

if wback && (n == 15 || n == t) then UNPREDICTABLE;

Assembler syntax

STRB<c><q> <Rt>, [<Rn> {, #+/-<imm>}]	Offset: index==TRUE, wback==FALSE
STRB<c><q> <Rt>, [<Rn>, #+/-<imm>]!	Pre-indexed: index==TRUE, wback==TRUE
STRB<c><q> <Rt>, [<Rn>], #+/-<imm>	Post-indexed: index==FALSE, wback==TRUE

where:

<c><q>	See <i>Standard assembler syntax fields</i> on page A8-7.
<Rt>	The source register.
<Rn>	The base register. The SP can be used. For offset addressing only, the PC can be used. However, use of the PC is deprecated.
+/-	Is + or omitted if the immediate offset is to be added to the base register value (add == TRUE), or – if it is to be subtracted (add == FALSE). #0 and #-0 generate different instructions.
<imm>	The immediate offset used to form the address. Values are 0-4095. For the offset addressing syntax, <imm> can be omitted, meaning an offset of 0.

The pre-UAL syntax STR<c>B is equivalent to STRB<c>.

Operation

```

if ConditionPassed() then
    EncodingSpecificOperations();
    offset_addr = if add then (R[n] + imm32) else (R[n] - imm32);
    address = if index then offset_addr else R[n];
    MemU[address,1] = R[t]<7:0>;
    if wback then R[n] = offset_addr;

```

Exceptions

Data Abort.

A8.6.198 STRB (register)

Store Register Byte (register) calculates an address from a base register value and an offset register value, and stores a byte from a register to memory. The offset register value can optionally be shifted. For information about memory accesses see *Memory accesses* on page A8-13.

Encoding T1 ARMv4T, ARMv5T*, ARMv6*, ARMv7

STRB<c> <Rt>, [<Rn>, <Rm>]

15	14	13	12	11	10	9	8	7	6	5	4	3	2	1	0
0	1	0	1	0	1	0		Rm		Rn					Rt

t = UInt(Rt); n = UInt(Rn); m = UInt(Rm);
 index = TRUE; add = TRUE; wback = FALSE;
 (shift_t, shift_n) = (SRTYPE_LSL, 0);

Encoding T2 ARMv6T2, ARMv7

STRB<c>.W <Rt>, [<Rn>, <Rm>{, LSL #<imm2>}]

15	14	13	12	11	10	9	8	7	6	5	4	3	2	1	0	15	14	13	12	11	10	9	8	7	6	5	4	3	2	1	0
1	1	1	1	1	0	0	0	0	0	0	0		Rn					Rt		0	0	0	0	0	0	imm2		Rm			

if Rn == '1111' then UNDEFINED;
 t = UInt(Rt); n = UInt(Rn); m = UInt(Rm);
 index = TRUE; add = TRUE; wback = FALSE;
 (shift_t, shift_n) = (SRTYPE_LSL, UInt(imm2));
 if BadReg(t) || BadReg(m) then UNPREDICTABLE;

Encoding A1 ARMv4*, ARMv5T*, ARMv6*, ARMv7

STRB<c> <Rt>, [<Rn>, +/-<Rm>{, <shift>}]{!}

STRB<c> <Rt>, [<Rn>], +/-<Rm>{, <shift>}

31	30	29	28	27	26	25	24	23	22	21	20	19	18	17	16	15	14	13	12	11	10	9	8	7	6	5	4	3	2	1	0
cond		0	1	1	P	U	1	W	0		Rn		Rt			imm5	type	0												Rm	

if P == '0' && W == '1' then SEE STRBT;
 t = UInt(Rt); n = UInt(Rn); m = UInt(Rm);
 index = (P == '1'); add = (U == '1'); wback = (P == '0') || (W == '1');
 (shift_t, shift_n) = DecodeImmShift(type, imm5);
 if t == 15 || m == 15 then UNPREDICTABLE;
 if wback && (n == 15 || n == t) then UNPREDICTABLE;
 if ArchVersion() < 6 && wback && m == n then UNPREDICTABLE;

Assembler syntax

STRB<c><q> <Rt>, [<Rn>, <Rm>{, <shift>}]	Offset: index==TRUE, wback==FALSE
STRB<c><q> <Rt>, [<Rn>, <Rm>{, <shift>}]!	Pre-indexed: index==TRUE, wback==TRUE
STRB<c><q> <Rt>, [<Rn>], <Rm>{, <shift>}	Post-indexed: index==FALSE, wback==TRUE

where:

<c><q>	See <i>Standard assembler syntax fields</i> on page A8-7.
<Rt>	The source register.
<Rn>	The base register. The SP can be used. In the ARM instruction set, for offset addressing only, the PC can be used. However, use of the PC is deprecated.
+/-	Is + or omitted if the optionally shifted value of <Rm> is to be added to the base register value (add == TRUE), or – if it is to be subtracted (permitted in ARM code only, add == FALSE).
<Rm>	Contains the offset that is optionally shifted and added to the value of <Rn> to form the address.
<shift>	The shift to apply to the value read from <Rm>. If present, encoding T1 is not permitted. If absent, no shift is applied and all encodings are permitted. For encoding T2, <shift> can only be omitted, encoded as imm2 = 0b00, or LSL #<imm> with <imm> = 1, 2, or 3, and <imm> encoded in imm2. For encoding A1, see <i>Shifts applied to a register</i> on page A8-10.

The pre-UAL syntax STR<c>B is equivalent to STRB<c>.

Operation

```

if ConditionPassed() then
    EncodingSpecificOperations(); NullCheckIFThumbEE(n);
    offset = Shift(R[m], shift_t, shift_n, APSR.C);
    offset_addr = if add then (R[n] + offset) else (R[n] - offset);
    address = if index then offset_addr else R[n];
    MemU[address,1] = R[t]<7:0>;
    if wback then R[n] = offset_addr;

```

Exceptions

Data Abort.

A8.6.199 STRBT

Store Register Byte Unprivileged ~~and~~ stores a byte from a register to memory. For information about memory accesses see *Memory accesses* on page A8-13.

The memory access is restricted as if the processor were running in User mode. (This makes no difference if the processor is actually running in User mode.)

The Thumb instruction uses an offset addressing mode, that calculates the address used for the memory access from a base register value and an immediate offset, and leaves the base register unchanged.

The ARM instruction uses a post-indexed addressing mode, that uses a base register value as the address for the memory access, and calculates a new address from a base register value and an offset and writes it back to the base register. The offset can be an immediate value or an optionally-shifted register value.

Encoding T1 ARMv6T2, ARMv7

STRBT<c> <Rt>, [<Rn>, #<imm8>]

15	14	13	12	11	10	9	8	7	6	5	4	3	2	1	0	15	14	13	12	11	10	9	8	7	6	5	4	3	2	1	0
1	1	1	1	1	0	0	0	0	0	0	0	Rn				Rt				1	1	1	0	imm8							

```

if Rn == '1111' then UNDEFINED;
t = UInt(Rt); n = UInt(Rn); postindex = FALSE; add = TRUE;
register_form = FALSE; imm32 = ZeroExtend(imm8, 32);
if BadReg(t) then UNPREDICTABLE;

```

Encoding A1 ARMv4*, ARMv5T*, ARMv6*, ARMv7

STRBT<c> <Rt>, [<Rn>], #+/-<imm12>

31	30	29	28	27	26	25	24	23	22	21	20	19	18	17	16	15	14	13	12	11	10	9	8	7	6	5	4	3	2	1	0
cond		0	1	0	0	U	1	1	0	Rn	Rt	imm12																			

```

t = UInt(Rt); n = UInt(Rn); postindex = TRUE; add = (U == '1');
register_form = FALSE; imm32 = ZeroExtend(imm12, 32);
if t == 15 || n == 15 || n == t then UNPREDICTABLE;

```

Encoding A2 ARMv4*, ARMv5T*, ARMv6*, ARMv7

STRBT<c> <Rt>, [<Rn>], +/-<Rm>{, <shift>}

31	30	29	28	27	26	25	24	23	22	21	20	19	18	17	16	15	14	13	12	11	10	9	8	7	6	5	4	3	2	1	0
cond		0	1	1	0	U	1	1	0	Rn	Rt	imm5			type	0	Rm														

```

t = UInt(Rt); n = UInt(Rn); m = UInt(Rm); postindex = TRUE; add = (U == '1');
register_form = TRUE; (shift_t, shift_n) = DecodeImmShift(type, imm5);
if t == 15 || n == 15 || n == t || m == 15 then UNPREDICTABLE;
if ArchVersion() < 6 && m == n then UNPREDICTABLE;

```

Assembler syntax

STRBT<c><q> <Rt>, [<Rn> {, #<imm>}]	Offset: Thumb only
STRBT<c><q> <Rt>, [<Rn>] {, #<imm>}	Post-indexed: ARM only
STRBT<c><q> <Rt>, [<Rn>], +/-<Rm> {, <shift>}	Post-indexed: ARM only

where:

<c><q>	See <i>Standard assembler syntax fields</i> on page A8-7.
<Rt>	The source register.
<Rn>	The base register. The SP can be used.
+/-	Is + or omitted if <imm> or the optionally shifted value of <Rm> is to be added to the base register value (add == TRUE), or – if it is to be subtracted (permitted in ARM code only, add == FALSE).
<imm>	The immediate offset applied to the value of <Rn>. Values are 0-255 for encoding T1, and 0-4095 for encoding A1. <imm> can be omitted, meaning an offset of 0.
<Rm>	Contains the offset that is optionally shifted and added to the value of <Rn> to form the address.
<shift>	The shift to apply to the value read from <Rm>. If omitted, no shift is applied. <i>Shifts applied to a register</i> on page A8-10 describes the shifts and how they are encoded.

The pre-UAL syntax STR<c>BT is equivalent to STRBT<c>.

Operation

```

if ConditionPassed() then
    EncodingSpecificOperations();  NullCheckIfThumbEE(n);
    offset = if register_form then Shift(R[m], shift_t, shift_n, APSR.C) else imm32;
    offset_addr = if add then (R[n] + offset) else (R[n] - offset);
    address = if postindex then R[n] else offset_addr;
    MemU_unpriv[address,1] = R[t]<7:0>;
    if postindex then R[n] = offset_addr;

```

Exceptions

Data Abort.

A8.6.200 STRD (immediate)

Store Register Dual (immediate) calculates an address from a base register value and an immediate offset, and stores two words from two registers to memory. It can use offset, post-indexed, or pre-indexed addressing. For information about memory accesses see *Memory accesses* on page A8-13.

Encoding T1 ARMv6T2, ARMv7

STRD<c> <Rt>, <Rt2>, [<Rn>{, #+/-<imm>}]

STRD<c> <Rt>, <Rt2>, [<Rn>], #+/-<imm>

STRD<c> <Rt>, <Rt2>, [<Rn>, #+/-<imm>]!

15	14	13	12	11	10	9	8	7	6	5	4	3	2	1	0	15	14	13	12	11	10	9	8	7	6	5	4	3	2	1	0
1	1	1	0	1	0	0	P	U	1	W	0	Rn				Rt				Rt2				imm8							

```

if P == '0' && W == '0' then SEE "Related encodings";
t = UInt(Rt); t2 = UInt(Rt2); n = UInt(Rn); imm32 = ZeroExtend(imm8:'00', 32);
index = (P == '1'); add = (U == '1'); wback = (W == '1');
if wback && (n == t || n == t2) then UNPREDICTABLE;
if n == 15 || BadReg(t) || BadReg(t2) then UNPREDICTABLE;
    
```

Encoding A1 ARMv5TE*, ARMv6*, ARMv7

STRD<c> <Rt>, <Rt2>, [<Rn>{, #+/-<imm8>}]

STRD<c> <Rt>, <Rt2>, [<Rn>], #+/-<imm8>

STRD<c> <Rt>, <Rt2>, [<Rn>, #+/-<imm8>]!

31	30	29	28	27	26	25	24	23	22	21	20	19	18	17	16	15	14	13	12	11	10	9	8	7	6	5	4	3	2	1	0
cond				0	0	0	P	U	1	W	0	Rn				Rt				imm4H				1	1	1	1	imm4L			

```

if Rt<0> == '1' then UNDEFINED;
t = UInt(Rt); t2 = t+1; n = UInt(Rn); imm32 = ZeroExtend(imm4H:imm4L, 32);
index = (P == '1'); add = (U == '1'); wback = (P == '0') || (W == '1');
if P == '0' && W == '1' then UNPREDICTABLE;
if wback && (n == 15 || n == t || n == t2) then UNPREDICTABLE;
if t2 == 15 then UNPREDICTABLE;
    
```

Related encodings See *Load/store dual*, *load/store exclusive*, *table branch* on page A6-24

Assembler syntax

STRD<c><q> <Rt>, <Rt2>, [<Rn> {, #+/-<imm>}]	Offset: index==TRUE, wback==FALSE
STRD<c><q> <Rt>, <Rt2>, [<Rn>, #+/-<imm>]!	Pre-indexed: index==TRUE, wback==TRUE
STRD<c><q> <Rt>, <Rt2>, [<Rn>], #+/-<imm>	Post-indexed: index==FALSE, wback==TRUE

where:

<c><q>	See <i>Standard assembler syntax fields</i> on page A8-7.
<Rt>	The first source register. For an ARM instruction, <Rt> must be even-numbered and not R14.
<Rt2>	The second source register. For an ARM instruction, <Rt2> must be <R(t+1)>.
<Rn>	The base register. The SP can be used. In the ARM instruction set, for offset addressing only, the PC can be used. However, use of the PC is deprecated.
+/-	Is + or omitted if the immediate offset is to be added to the base register value (add == TRUE), or – if it is to be subtracted (add == FALSE). #0 and #-0 generate different instructions.
<imm>	The immediate offset used to form the address. Values are multiples of 4 in the range 0-1020 for encoding T1, and any value in the range 0-255 for encoding A1. For the offset addressing syntax, <imm> can be omitted, meaning an offset of 0.

The pre-UAL syntax STR<c>D is equivalent to STRD<c>.

Operation

```
if ConditionPassed() then
    EncodingSpecificOperations(); NullCheckIfThumbEE(n);
    offset_addr = if add then (R[n] + imm32) else (R[n] - imm32);
    address = if index then offset_addr else R[n];
    MemA[address,4] = R[t];
    MemA[address+4,4] = R[t2];
    if wback then R[n] = offset_addr;
```

Exceptions

Data Abort.

A8.6.201 STRD (register)

Store Register Dual (register) calculates an address from a base register value and a register offset, and stores two words from two registers to memory. It can use offset, post-indexed, or pre-indexed addressing. For information about memory accesses see *Memory accesses* on page A8-13.

Encoding A1 ARMv5TE*, ARMv6*, ARMv7

STRD<c> <Rt>, <Rt2>, [<Rn>, +/-<Rm>]{!}

STRD<c> <Rt>, <Rt2>, [<Rn>], +/-<Rm>

	31	30	29	28	27	26	25	24	23	22	21	20	19	18	17	16	15	14	13	12	11	10	9	8	7	6	5	4	3	2	1	0
	cond			0	0	0	P	U	0	W	0	Rn				Rt				(0)	(0)	(0)	(0)	1	1	1	1	Rm				

```

if Rt<0> == '1' then UNDEFINED;
t = UInt(Rt); t2 = t+1; n = UInt(Rn); m = UInt(Rm);
index = (P == '1'); add = (U == '1'); wback = (P == '0') || (W == '1');
if P == '0' && W == '1' then UNPREDICTABLE;
if t2 == 15 || m == 15 then UNPREDICTABLE;
if wback && (n == 15 || n == t || n == t2) then UNPREDICTABLE;
if ArchVersion() < 6 && wback && m == n then UNPREDICTABLE;
    
```

Assembler syntax

STRD<c><q> <Rt>, <Rt2>, [<Rn>, +/-<Rm>]	Offset: index==TRUE, wback==FALSE
STRD<c><q> <Rt>, <Rt2>, [<Rn>, +/-<Rm>]!	Pre-indexed: index==TRUE, wback==TRUE
STRD<c><q> <Rt>, <Rt2>, [<Rn>], +/-<Rm>	Post-indexed: index==FALSE, wback==TRUE

where:

<c><q>	See <i>Standard assembler syntax fields</i> on page A8-7.
<Rt>	The first source register. This register must be even-numbered and not R14.
<Rt2>	The second source register. This register must be <R(t+1)>.
<Rn>	The base register. The SP can be used. For offset addressing only, the PC can be used. However, use of the PC is deprecated.
+/-	Is + or omitted if the immediate offset is to be added to the base register value (add == TRUE), or – if it is to be subtracted (add == FALSE).
<Rm>	Contains the offset that is added to the value of <Rn> to form the address.

The pre-UAL syntax STR<c>D is equivalent to STRD<c>.

Operation

```

if ConditionPassed() then
    EncodingSpecificOperations();
    offset_addr = if add then (R[n] + R[m]) else (R[n] - R[m]);
    address = if index then offset_addr else R[n];
    MemA[address,4] = R[t];
    MemA[address+4,4] = R[t2];
    if wback then R[n] = offset_addr;

```

Exceptions

Data Abort.

A8.6.202 STREX

Store Register Exclusive calculates an address from a base register value and an immediate offset, and stores a word from a register to memory if the executing processor has exclusive access to the memory addressed.

For more information about support for shared memory see *Synchronization and semaphores* on page A3-12. For information about memory accesses see *Memory accesses* on page A8-13.

Encoding T1 ARMv6T2, ARMv7

STREX<c> <Rd>, <Rt>, [<Rn>{, #<imm>}]

15	14	13	12	11	10	9	8	7	6	5	4	3	2	1	0	15	14	13	12	11	10	9	8	7	6	5	4	3	2	1	0
1	1	1	0	1	0	0	0	0	1	0	0	Rn				Rt				Rd				imm8							

```
d = UInt(Rd); t = UInt(Rt); n = UInt(Rn); imm32 = ZeroExtend(imm8:'00', 32);
if BadReg(d) || BadReg(t) || n == 15 then UNPREDICTABLE;
if d == n || d == t then UNPREDICTABLE;
```

Encoding A1 ARMv6*, ARMv7

STREX<c> <Rd>, <Rt>, [<Rn>]

31	30	29	28	27	26	25	24	23	22	21	20	19	18	17	16	15	14	13	12	11	10	9	8	7	6	5	4	3	2	1	0
cond			0	0	0	1	1	0	0	0	Rn				Rd				(1)	(1)	(1)	(1)	1	0	0	1	Rt				

```
d = UInt(Rd); t = UInt(Rt); n = UInt(Rn); imm32 = Zeros(32); // Zero offset
if d == 15 || t == 15 || n == 15 then UNPREDICTABLE;
if d == n || d == t then UNPREDICTABLE;
```

Assembler syntax

STREX<c><q> <Rd>, <Rt>, [<Rn> {, #<imm>}]

where:

<c><q>	See <i>Standard assembler syntax fields</i> on page A8-7.
<Rd>	The destination register for the returned status value. The value returned is: 0 if the operation updates memory 1 if the operation fails to update memory.
<Rt>	The source register.
<Rn>	The base register. The SP can be used.
<imm>	The immediate offset added to the value of <Rn> to form the address. Values are multiples of 4 in the range 0-1020 for encoding T1, and 0 for encoding A1. <imm> can be omitted, meaning an offset of 0.

Operation

```

if ConditionPassed() then
    EncodingSpecificOperations(); NullCheckIfThumbEE(n);
    address = R[n] + imm32;
    if ExclusiveMonitorsPass(address,4) then
        MemA[address,4] = R[t];
        R[d] = 0;
    else
        R[d] = 1;

```

Exceptions

Data Abort.

Aborts and alignment

If a synchronous Data Abort exception is generated by the execution of this instruction:

- memory is not updated
- <Rd> is not updated.

If `ExclusiveMonitorsPass()` returns FALSE and the memory address would generate a synchronous Data Abort exception if accessed, it is IMPLEMENTATION DEFINED whether the exception is generated.

If SCTLR.A and SCTLR.U are both 0, a non word-aligned memory address causes UNPREDICTABLE behavior. Otherwise, a non word-aligned memory address causes a Data Abort exception with type Alignment fault to be generated according to the following rules:

- if `ExclusiveMonitorsPass()` returns TRUE, the exception is generated
- otherwise, it is IMPLEMENTATION DEFINED whether the exception is generated.

A8.6.203 STREXB

Store Register Exclusive Byte derives an address from a base register value, and stores a byte from a register to memory if the executing processor has exclusive access to the memory addressed.

For more information about support for shared memory see *Synchronization and semaphores* on page A3-12. For information about memory accesses see *Memory accesses* on page A8-13.

Encoding T1 ARMv7

STREXB<c> <Rd>, <Rt>, [<Rn>]

15	14	13	12	11	10	9	8	7	6	5	4	3	2	1	0	15	14	13	12	11	10	9	8	7	6	5	4	3	2	1	0
1	1	1	0	1	0	0	0	1	1	0	0	Rn				Rt				(1)	(1)	(1)	(1)	0	1	0	0	Rd			

```
d = UInt(Rd); t = UInt(Rt); n = UInt(Rn);
if BadReg(d) || BadReg(t) || n == 15 then UNPREDICTABLE;
if d == n || d == t then UNPREDICTABLE;
```

Encoding A1 ARMv6K, ARMv7

STREXB<c> <Rd>, <Rt>, [<Rn>]

31	30	29	28	27	26	25	24	23	22	21	20	19	18	17	16	15	14	13	12	11	10	9	8	7	6	5	4	3	2	1	0
cond				0	0	0	1	1	1	0	0	Rn				Rd				(1)	(1)	(1)	(1)	1	0	0	1	Rt			

```
d = UInt(Rd); t = UInt(Rt); n = UInt(Rn);
if d == 15 || t == 15 || n == 15 then UNPREDICTABLE;
if d == n || d == t then UNPREDICTABLE;
```

Assembler syntax

STREXB<c><q> <Rd>, <Rt>, [<Rn>]

where:

<c><q> See *Standard assembler syntax fields* on page A8-7.

<Rd> The destination register for the returned status value. The value returned is:
 0 if the operation updates memory
 1 if the operation fails to update memory.

<Rt> The source register.

<Rn> The base register. The SP can be used.

Operation

```

if ConditionPassed() then
    EncodingSpecificOperations(); NullCheckIfThumbEE(n);
    address = R[n];
    if ExclusiveMonitorsPass(address,1) then
        MemA[address,1] = R[t];
        R[d] = 0;
    else
        R[d] = 1;

```

Exceptions

Data Abort.

Aborts

If a synchronous Data Abort exception is generated by the execution of this instruction:

- memory is not updated
- <Rd> is not updated.

If `ExclusiveMonitorsPass()` returns `FALSE` and the memory address would generate a synchronous Data Abort exception if accessed, it is IMPLEMENTATION DEFINED whether the exception is generated.

A8.6.204 STREXD

Store Register Exclusive Doubleword derives an address from a base register value, and stores a 64-bit doubleword from two registers to memory if the executing processor has exclusive access to the memory addressed.

For more information about support for shared memory see *Synchronization and semaphores* on page A3-12. For information about memory accesses see *Memory accesses* on page A8-13.

Encoding T1 ARMv7

STREXD<c> <Rd>, <Rt>, <Rt2>, [<Rn>]

15	14	13	12	11	10	9	8	7	6	5	4	3	2	1	0	15	14	13	12	11	10	9	8	7	6	5	4	3	2	1	0
1	1	1	0	1	0	0	0	1	1	0	0	Rn				Rt				Rt2				0	1	1	1	Rd			

d = UInt(Rd); t = UInt(Rt); t2 = UInt(Rt2); n = UInt(Rn);
 if BadReg(d) || BadReg(t) || BadReg(t2) || n == 15 then UNPREDICTABLE;
 if d == n || d == t || d == t2 then UNPREDICTABLE;

Encoding A1 ARMv6K, ARMv7

STREXD<c> <Rd>, <Rt>, <Rt2>, [<Rn>]

31	30	29	28	27	26	25	24	23	22	21	20	19	18	17	16	15	14	13	12	11	10	9	8	7	6	5	4	3	2	1	0			
cond				0	0	0	1	1	0	1	0	Rn				Rd				(1)	(1)	(1)	(1)	1				0	0	1	Rt			

d = UInt(Rd); t = UInt(Rt); t2 = t+1; n = UInt(Rn);
 if d == 15 || Rt<0> = '1' || Rt == '1110' || n == 15 then UNPREDICTABLE;
 if d == n || d == t || d == t2 then UNPREDICTABLE;

Assembler syntax

STREXD<c><q> <Rd>, <Rt>, <Rt2>, [<Rn>]

where:

<c><q>	See <i>Standard assembler syntax fields</i> on page A8-7.
<Rd>	The destination register for the returned status value. The value returned is: 0 if the operation updates memory 1 if the operation fails to update memory.
<Rt>	The first source register.
<Rt2>	The second source register.
<Rn>	The base register. The SP can be used.

Operation

```

if ConditionPassed() then
    EncodingSpecificOperations(); NullCheckIfThumbEE(n);
    address = R[n];
    // Create doubleword to store such that R[t] will be stored at address and R[t2] at address+4.
    value = if BigEndian() then R[t]:R[t2] else R[t2]:R[t];
    if ExclusiveMonitorsPass(address,8) then
        MemA[address,8] = value; R[d] = 0;
    else
        R[d] = 1;

```

Exceptions

Data Abort.

Aborts and alignment

If a synchronous Data Abort exception is generated by the execution of this instruction:

- memory is not updated
- <Rd> is not updated.

If `ExclusiveMonitorsPass()` returns FALSE and the memory address would generate a synchronous Data Abort exception if accessed, it is IMPLEMENTATION DEFINED whether the exception is generated.

If SCTL.R.A and SCTL.R.U are both 0, a non doubleword-aligned memory address causes UNPREDICTABLE behavior. Otherwise, a non doubleword-aligned memory address causes a Data Abort exception with type Alignment fault to be generated according to the following rules:

- if `ExclusiveMonitorsPass()` returns TRUE, the exception is generated
- otherwise, it is IMPLEMENTATION DEFINED whether the exception is generated.

A8.6.205 STREXH

Store Register Exclusive Halfword derives an address from a base register value, and stores a halfword from a register to memory if the executing processor has exclusive access to the memory addressed.

For more information about support for shared memory see *Synchronization and semaphores* on page A3-12. For information about memory accesses see *Memory accesses* on page A8-13.

Encoding T1 ARMv7

STREXH<c> <Rd>, <Rt>, [<Rn>]

15	14	13	12	11	10	9	8	7	6	5	4	3	2	1	0	15	14	13	12	11	10	9	8	7	6	5	4	3	2	1	0
1	1	1	0	1	0	0	0	1	1	0	0	Rn			Rt			(1)	(1)	(1)	(1)	0	1	0	1	Rd					

d = UInt(Rd); t = UInt(Rt); n = UInt(Rn);
 if BadReg(d) || BadReg(t) || n == 15 then UNPREDICTABLE;
 if d == n || d == t then UNPREDICTABLE;

Encoding A1 ARMv6K, ARMv7

STREXH<c> <Rd>, <Rt>, [<Rn>]

31	30	29	28	27	26	25	24	23	22	21	20	19	18	17	16	15	14	13	12	11	10	9	8	7	6	5	4	3	2	1	0
cond		0	0	0	1	1	1	1	0	Rn			Rd			(1)	(1)	(1)	(1)	1	0	0	1	Rt							

d = UInt(Rd); t = UInt(Rt); n = UInt(Rn);
 if d == 15 || t == 15 || n == 15 then UNPREDICTABLE;
 if d == n || d == t then UNPREDICTABLE;

Assembler syntax

STREXH<c><q> <Rd>, <Rt>, [<Rn>]

where:

<c><q> See *Standard assembler syntax fields* on page A8-7.

<Rd> The destination register for the returned status value. The value returned is:
 0 if the operation updates memory
 1 if the operation fails to update memory.

<Rt> The source register.

<Rn> The base register. The SP can be used.

Operation

```

if ConditionPassed() then
    EncodingSpecificOperations(); NullCheckIfThumbEE(n);
    address = R[n];
    if ExclusiveMonitorsPass(address,2) then
        MemA[address,2] = R[t];
        R[d] = 0;
    else
        R[d] = 1;

```

Exceptions

Data Abort.

Aborts and alignment

If a synchronous Data Abort exception is generated by the execution of this instruction:

- memory is not updated
- <Rd> is not updated.

If ExclusiveMonitorsPass() returns FALSE and the memory address would generate a synchronous Data Abort exception if accessed, it is IMPLEMENTATION DEFINED whether the exception is generated.

If SCTL.R.A and SCTL.R.U are both 0, a non halfword-aligned memory address causes UNPREDICTABLE behavior. Otherwise, a non halfword-aligned memory address causes a Data Abort exception with type Alignment fault to be generated according to the following rules:

- if ExclusiveMonitorsPass() returns TRUE, the exception is generated
- otherwise, it is IMPLEMENTATION DEFINED whether the exception is generated.

A8.6.206 STRH (immediate, Thumb)

Store Register Halfword (immediate) calculates an address from a base register value and an immediate offset, and stores a halfword from a register to memory. It can use offset, post-indexed, or pre-indexed addressing. For information about memory accesses see *Memory accesses* on page A8-13.

Encoding T1 ARMv4T, ARMv5T*, ARMv6*, ARMv7

STRH<c> <Rt>, [<Rn>{, #<imm5>}]

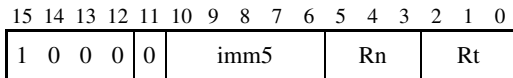

t = UInt(Rt); n = UInt(Rn); imm32 = ZeroExtend(imm5:'0', 32);
 index = TRUE; add = TRUE; wback = FALSE;

Encoding T2 ARMv6T2, ARMv7

STRH<c>.W <Rt>, [<Rn>{, #<imm12>}]

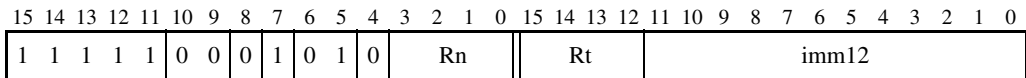

if Rn == '1111' then UNDEFINED;
 t = UInt(Rt); n = UInt(Rn); imm32 = ZeroExtend(imm12, 32);
 index = TRUE; add = TRUE; wback = FALSE;
 if BadReg(t) then UNPREDICTABLE;

Encoding T3 ARMv6T2, ARMv7

STRH<c> <Rt>, [<Rn>, #-<imm8>]

STRH<c> <Rt>, [<Rn>], #+/-<imm8>

STRH<c> <Rt>, [<Rn>, #+/-<imm8>]!

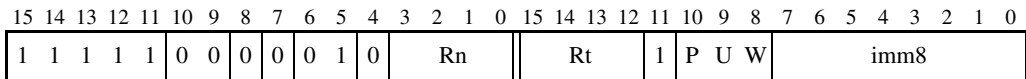

if P == '1' && U == '1' && W == '0' then SEE STRHT;
 if Rn == '1111' || (P == '0' && W == '0') then UNDEFINED;
 t = UInt(Rt); n = UInt(Rn); imm32 = ZeroExtend(imm8, 32);
 index = (P == '1'); add = (U == '1'); wback = (W == '1');
 if BadReg(t) || (wback && n == t) then UNPREDICTABLE;

Assembler syntax

STRH<c><q> <Rt>, [<Rn> {, #+/-<imm>}]	Offset: index==TRUE, wback==FALSE
STRH<c><q> <Rt>, [<Rn>, #+/-<imm>!]	Pre-indexed: index==TRUE, wback==TRUE
STRH<c><q> <Rt>, [<Rn>], #+/-<imm>	Post-indexed: index==FALSE, wback==TRUE

where:

<c><q>	See <i>Standard assembler syntax fields</i> on page A8-7.
<Rt>	The source register.
<Rn>	The base register. The SP can be used.
+/-	Is + or omitted if the immediate offset is to be added to the base register value (add == TRUE), or – if it is to be subtracted (add == FALSE). #0 and #-0 generate different instructions.
<imm>	The immediate offset used to form the address. Values are: <ul style="list-style-type: none"> Encoding T1 multiples of 2 in the range 0-62 Encoding T2 any value in the range 0-4095 Encoding T3 any value in the range 0-255. For the offset addressing syntax, <imm> can be omitted, meaning an offset of 0.

The pre-UAL syntax STR<c>H is equivalent to STRH<c>.

Operation

```

if ConditionPassed() then
    EncodingSpecificOperations(); NullCheckIfThumbEE(n);
    offset_addr = if add then (R[n] + imm32) else (R[n] - imm32);
    address = if index then offset_addr else R[n];
    if UnalignedSupport() || address<0> == '0' then
        MemU[address,2] = R[t]<15:0>;
    else // Can only occur before ARMv7
        MemU[address,2] = bits(16) UNKNOWN;
    if wback then R[n] = offset_addr;

```

Exceptions

Data Abort.

A8.6.207 STRH (immediate, ARM)

Store Register Halfword (immediate) calculates an address from a base register value and an immediate offset, and stores a halfword from a register to memory. It can use offset, post-indexed, or pre-indexed addressing. For information about memory accesses see *Memory accesses* on page A8-13.

Encoding A1 ARMv4*, ARMv5T*, ARMv6*, ARMv7

STRH<c> <Rt>, [<Rn>{, #+/-<imm8>}]

STRH<c> <Rt>, [<Rn>], #+/-<imm8>

STRH<c> <Rt>, [<Rn>, #+/-<imm8>]!

31	30	29	28	27	26	25	24	23	22	21	20	19	18	17	16	15	14	13	12	11	10	9	8	7	6	5	4	3	2	1	0
cond		0	0	0	P	U	1	W	0	Rn				Rt				imm4H				1	0	1	1	imm4L					

if P == '0' && W == '1' then SEE STRHT;

t = UInt(Rt); n = UInt(Rn); imm32 = ZeroExtend(imm4H:imm4L, 32);

index = (P == '1'); add = (U == '1'); wback = (P == '0') || (W == '1');

if t == 15 then UNPREDICTABLE;

if wback && (n == 15 || n == t) then UNPREDICTABLE;

Assembler syntax

STRH<c><q> <Rt>, [<Rn> {, #+/-<imm>}]	Offset: index==TRUE, wback==FALSE
STRH<c><q> <Rt>, [<Rn>, #+/-<imm>]!	Pre-indexed: index==TRUE, wback==TRUE
STRH<c><q> <Rt>, [<Rn>], #+/-<imm>	Post-indexed: index==FALSE, wback==TRUE

where:

<c><q>	See <i>Standard assembler syntax fields</i> on page A8-7.
<Rt>	The source register.
<Rn>	The base register. The SP can be used. For offset addressing only, the PC can be used. However, use of the PC is deprecated.
+/-	Is + or omitted if the immediate offset is to be added to the base register value (add == TRUE), or – if it is to be subtracted (add == FALSE). #0 and #-0 generate different instructions.
<imm>	The immediate offset used to form the address. Values are 0-255. For the offset addressing syntax, <imm> can be omitted, meaning an offset of 0.

The pre-UAL syntax STR<c>H is equivalent to STRH<c>.

Operation

```

if ConditionPassed() then
    EncodingSpecificOperations();
    offset_addr = if add then (R[n] + imm32) else (R[n] - imm32);
    address = if index then offset_addr else R[n];
    if UnalignedSupport() || address<0> == '0' then
        MemU[address,2] = R[t]<15:0>;
    else // Can only occur before ARMv7
        MemU[address,2] = bits(16) UNKNOWN;
    if wback then R[n] = offset_addr;

```

Exceptions

Data Abort.

A8.6.208 STRH (register)

Store Register Halfword (register) calculates an address from a base register value and an offset register value, and stores a halfword from a register to memory. The offset register value can be shifted left by 0, 1, 2, or 3 bits. For information about memory accesses see *Memory accesses* on page A8-13.

Encoding T1 ARMv4T, ARMv5T*, ARMv6*, ARMv7

STRH<c> <Rt>, [<Rn>, <Rm>]

15	14	13	12	11	10	9	8	7	6	5	4	3	2	1	0
0	1	0	1	0	0	1	Rm	Rn	Rt						

```
if CurrentInstrSet() == InstrSet_ThumbEE then SEE "Modified operation in ThumbEE";
t = UInt(Rt); n = UInt(Rn); m = UInt(Rm);
index = TRUE; add = TRUE; wback = FALSE;
(shift_t, shift_n) = (SRTYPE_LSL, 0);
```

Encoding T2 ARMv6T2, ARMv7

STRH<c>.W <Rt>, [<Rn>, <Rm>{, LSL #<imm2>}]

15	14	13	12	11	10	9	8	7	6	5	4	3	2	1	0	15	14	13	12	11	10	9	8	7	6	5	4	3	2	1	0
1	1	1	1	1	0	0	0	0	0	1	0	Rn	Rt	0	0	0	0	0	0	0	imm2	Rm									

```
if Rn == '1111' then UNDEFINED;
t = UInt(Rt); n = UInt(Rn); m = UInt(Rm);
index = TRUE; add = TRUE; wback = FALSE;
(shift_t, shift_n) = (SRTYPE_LSL, UInt(imm2));
if BadReg(t) || BadReg(m) then UNPREDICTABLE;
```

Encoding A1 ARMv4*, ARMv5T*, ARMv6*, ARMv7

STRH<c> <Rt>, [<Rn>, +/-<Rm>]{!}

STRH<c> <Rt>, [<Rn>], +/-<Rm>

31	30	29	28	27	26	25	24	23	22	21	20	19	18	17	16	15	14	13	12	11	10	9	8	7	6	5	4	3	2	1	0
cond	0	0	0	P	U	0	W	0	Rn	Rt	(0)	(0)	(0)	(0)	1	0	1	1	Rm												

```
if P == '0' && W == '1' then SEE STRHT;
t = UInt(Rt); n = UInt(Rn); m = UInt(Rm);
index = (P == '1'); add = (U == '1'); wback = (P == '0') || (W == '1');
(shift_t, shift_n) = (SRTYPE_LSL, 0);
if t == 15 || m == 15 then UNPREDICTABLE;
if wback && (n == 15 || n == t) then UNPREDICTABLE;
if ArchVersion() < 6 && wback && m == n then UNPREDICTABLE;
```

Modified operation in ThumbEESee *STRH (register)* on page A9-13

Assembler syntax

STRH<c><q> <Rt>, [<Rn>, +/-<Rm>{, LSL #<imm>}]	Offset: index==TRUE, wback==FALSE
STRH<c><q> <Rt>, [<Rn>, +/-<Rm>!]	Pre-indexed: index==TRUE, wback==TRUE
STRH<c><q> <Rt>, [<Rn>], +/-<Rm>	Post-indexed: index==FALSE, wback==TRUE

where:

<c><q>	See <i>Standard assembler syntax fields</i> on page A8-7.
<Rt>	The source register.
<Rn>	The base register. The SP can be used. In the ARM instruction set, for offset addressing only, the PC can be used. However, use of the PC is deprecated.
+/-	Is + or omitted if the optionally shifted value of <Rm> is to be added to the base register value (add == TRUE), or – if it is to be subtracted (permitted in ARM code only, add == FALSE).
<Rm>	Contains the offset that is optionally left shifted and added to the value of <Rn> to form the address.
<imm>	If present, the size of the left shift to apply to the value from <Rm>, in the range 1-3. Only encoding T2 is permitted, and <imm> is encoded in imm2. If absent, no shift is specified and all encodings are permitted. In encoding T2, imm2 is encoded as 0b00.

The pre-UAL syntax STR<c>H is equivalent to STRH<c>.

Operation

```

if ConditionPassed() then
    EncodingSpecificOperations(); NullCheckIfThumbEE(n);
    offset = Shift(R[m], shift_t, shift_n, APSR.C);
    offset_addr = if add then (R[n] + offset) else (R[n] - offset);
    address = if index then offset_addr else R[n];
    if UnalignedSupport() || address<0> == '0' then
        MemU[address,2] = R[t]<15:0>;
    else // Can only occur before ARMv7
        MemU[address,2] = bits(16) UNKNOWN;
    if wback then R[n] = offset_addr;

```

Exceptions

Data Abort.

A8.6.209 STRHT

Store Register Halfword Unprivileged ~~and~~ stores a halfword from a register to memory. For information about memory accesses see *Memory accesses* on page A8-13.

The memory access is restricted as if the processor were running in User mode. (This makes no difference if the processor is actually running in User mode.)

The Thumb instruction uses an offset addressing mode, that calculates the address used for the memory access from a base register value and an immediate offset, and leaves the base register unchanged.

The ARM instruction uses a post-indexed addressing mode, that uses a base register value as the address for the memory access, and calculates a new address from a base register value and an offset and writes it back to the base register. The offset can be an immediate value or a register value.

Encoding T1 ARMv6T2, ARMv7

STRHT<c> <Rt>, [<Rn>,<#imm8>]

15	14	13	12	11	10	9	8	7	6	5	4	3	2	1	0	15	14	13	12	11	10	9	8	7	6	5	4	3	2	1	0
1	1	1	1	1	0	0	0	0	0	1	0	Rn				Rt				1	1	1	0	imm8							

```
if Rn == '1111' then UNDEFINED;
t = UInt(Rt); n = UInt(Rn); postindex = FALSE; add = TRUE;
register_form = FALSE; imm32 = ZeroExtend(imm8, 32);
if BadReg(t) then UNPREDICTABLE;
```

Encoding A1 ARMv6T2, ARMv7

STRHT<c> <Rt>, [<Rn>] {, #+/-<imm8>}

31	30	29	28	27	26	25	24	23	22	21	20	19	18	17	16	15	14	13	12	11	10	9	8	7	6	5	4	3	2	1	0
cond		0	0	0	0	U	1	1	0	Rn				Rt				imm4H				1	0	1	1	imm4L					

```
t = UInt(Rt); n = UInt(Rn); postindex = TRUE; add = (U == '1');
register_form = FALSE; imm32 = ZeroExtend(imm4H:imm4L, 32);
if t == 15 || n == 15 || n == t then UNPREDICTABLE;
```

Encoding A2 ARMv6T2, ARMv7

STRHT<c> <Rt>, [<Rn>], +/-<Rm>

31	30	29	28	27	26	25	24	23	22	21	20	19	18	17	16	15	14	13	12	11	10	9	8	7	6	5	4	3	2	1	0	
cond		0	0	0	0	U	0	1	0	Rn				Rt				(0)	(0)	(0)	(0)	1				0	1	1	Rm			

```
t = UInt(Rt); n = UInt(Rn); m = UInt(Rm); postindex = TRUE; add = (U == '1');
register_form = TRUE;
if t == 15 || n == 15 || n == t || m == 15 then UNPREDICTABLE;
```

Assembler syntax

STRHT<C><q> <Rt>, [<Rn> {, #<imm>}]	Offset: Thumb only
STRHT<C><q> <Rt>, [<Rn>] {, #+/-<imm>}	Post-indexed: ARM only
STRHT<C><q> <Rt>, [<Rn>], +/-<Rm>	Post-indexed: ARM only

where:

<C><q>	See <i>Standard assembler syntax fields</i> on page A8-7.
<Rt>	The source register.
<Rn>	The base register. The SP can be used.
+/-	Is + or omitted if <imm> or the optionally shifted value of <Rm> is to be added to the base register value (add == TRUE), or – if it is to be subtracted (permitted in ARM code only, add == FALSE).
<imm>	The immediate offset applied to the value of <Rn>. Any value in the range 0-255 is permitted. <imm> can be omitted, meaning an offset of 0.
<Rm>	Contains the offset that is applied to the value of <Rn> to form the address.

Operation

```

if ConditionPassed() then
    EncodingSpecificOperations(); NullCheckIfThumbEE(n);
    offset = if register_form then R[m] else imm32;
    offset_addr = if add then (R[n] + offset) else (R[n] - offset);
    address = if postindex then R[n] else offset_addr;
    if UnalignedSupport() || address<0> == '0' then
        MemU_unpriv[address,2] = R[t]<15:0>;
    else // Can only occur before ARMv7
        MemU_unpriv[address,2] = bits(16) UNKNOWN;
    if postindex then R[n] = offset_addr;

```

Exceptions

Data Abort.

A8.6.210 STRT

Store Register Unprivileged ~~and~~ stores a word from a register to memory. For information about memory accesses see *Memory accesses* on page A8-13.

The memory access is restricted as if the processor were running in User mode. (This makes no difference if the processor is actually running in User mode.)

The Thumb instruction uses an offset addressing mode, that calculates the address used for the memory access from a base register value and an immediate offset, and leaves the base register unchanged.

The ARM instruction uses a post-indexed addressing mode, that uses a base register value as the address for the memory access, and calculates a new address from a base register value and an offset and writes it back to the base register. The offset can be an immediate value or an optionally-shifted register value.

Encoding T1 ARMv6T2, ARMv7

STRT<c> <Rt>, [<Rn>, #<imm8>]

15	14	13	12	11	10	9	8	7	6	5	4	3	2	1	0	15	14	13	12	11	10	9	8	7	6	5	4	3	2	1	0
1	1	1	1	1	0	0	0	0	1	0	0	Rn				Rt				1	1	1	0	imm8							

```
if Rn == '1111' then UNDEFINED;
t = UInt(Rt); n = UInt(Rn); postindex = FALSE; add = TRUE;
register_form = FALSE; imm32 = ZeroExtend(imm8, 32);
if BadReg(t) then UNPREDICTABLE;
```

Encoding A1 ARMv4*, ARMv5T*, ARMv6*, ARMv7

STRT<c> <Rt>, [<Rn>] {, +/-<imm12>}

31	30	29	28	27	26	25	24	23	22	21	20	19	18	17	16	15	14	13	12	11	10	9	8	7	6	5	4	3	2	1	0
cond		0	1	0	0	U	0	1	0	Rn				Rt				imm12													

```
t = UInt(Rt); n = UInt(Rn); postindex = TRUE; add = (U == '1');
register_form = FALSE; imm32 = ZeroExtend(imm12, 32);
if n == 15 || n == t then UNPREDICTABLE;
```

Encoding A2 ARMv4*, ARMv5T*, ARMv6*, ARMv7

STRT<c> <Rt>, [<Rn>], +/-<Rm>{, <shift>}

31	30	29	28	27	26	25	24	23	22	21	20	19	18	17	16	15	14	13	12	11	10	9	8	7	6	5	4	3	2	1	0
cond		0	1	1	0	U	0	1	0	Rn				Rt				imm5			type	0	Rm								

```
t = UInt(Rt); n = UInt(Rn); m = UInt(Rm); postindex = TRUE; add = (U == '1');
register_form = TRUE; (shift_t, shift_n) = DecodeImmShift(type, imm5);
if n == 15 || n == t || m == 15 then UNPREDICTABLE;
if ArchVersion() < 6 && m == n then UNPREDICTABLE;
```

Assembler syntax

STRT<c><q> <Rt>, [<Rn> {, #<imm>}]	Offset: Thumb only
STRT<c><q> <Rt>, [<Rn>] {, #+/-<imm>}	Post-indexed: ARM only
STRT<c><q> <Rt>, [<Rn>], +/-<Rm> {, <shift>}	Post-indexed: ARM only

where:

<c><q>	See <i>Standard assembler syntax fields</i> on page A8-7.
<Rt>	The source register. In the ARM instruction set, the PC can be used. However, use of the PC is deprecated.
<Rn>	The base register. The SP can be used.
+/-	Is + or omitted if <imm> or the optionally shifted value of <Rm> is to be added to the base register value (add == TRUE), or – if it is to be subtracted (permitted in ARM code only, add == FALSE).
<imm>	The immediate offset applied to the value of <Rn>. Values are 0-255 for encoding T1, and 0-4095 for encoding A1. <imm> can be omitted, meaning an offset of 0.
<Rm>	Contains the offset that is optionally shifted and added to the value of <Rn> to form the address.
<shift>	The shift to apply to the value read from <Rm>. If omitted, no shift is applied. <i>Shifts applied to a register</i> on page A8-10 describes the shifts and how they are encoded.

The pre-UAL syntax STR<c>T is equivalent to STRT<c>.

Operation

```

if ConditionPassed() then
    EncodingSpecificOperations(); NullCheckIfThumbEE(n);
    offset = if register_form then Shift(R[m], shift_t, shift_n, APSR.C) else imm32;
    offset_addr = if add then (R[n] + offset) else (R[n] - offset);
    address = if postindex then R[n] else offset_addr;
    if t == 15 then // Only possible for encodings A1 and A2
        data = PCStoreValue();
    else
        data = R[t];
    if UnalignedSupport() || address<1:0> == '00' || CurrentInstrSet() == InstrSet_ARM then
        MemU_unpriv[address,4] = data;
    else // Can only occur before ARMv7
        MemU_unpriv[address,4] = bits(32) UNKNOWN;
    if postindex then R[n] = offset_addr;

```

Exceptions

Data Abort.

A8.6.211 SUB (immediate, Thumb)

This instruction subtracts an immediate value from a register value, and writes the result to the destination register. It can optionally update the condition flags based on the result.

Encoding T1 ARMv4T, ARMv5T*, ARMv6*, ARMv7

SUBS <Rd>, <Rn>, #<imm3> Outside IT block.

SUB<c> <Rd>, <Rn>, #<imm3> Inside IT block.

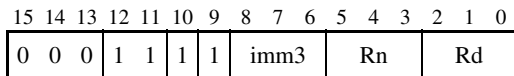

d = UInt(Rd); n = UInt(Rn); setflags = !InITBlock(); imm32 = ZeroExtend(imm3, 32);

Encoding T2 ARMv4T, ARMv5T*, ARMv6*, ARMv7

SUBS <Rdn>, #<imm8> Outside IT block.

SUB<c> <Rdn>, #<imm8> Inside IT block.

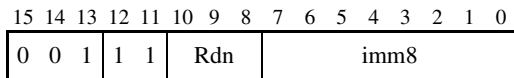

d = UInt(Rdn); n = UInt(Rdn); setflags = !InITBlock(); imm32 = ZeroExtend(imm8, 32);

Encoding T3 ARMv6T2, ARMv7

SUB{S}<c>.W <Rd>, <Rn>, #<const>

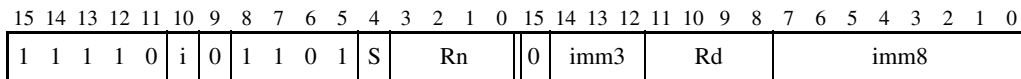

if Rd == '1111' && setflags then SEE CMP (immediate);
 if Rn == '1101' then SEE SUB (SP minus immediate);
 d = UInt(Rd); n = UInt(Rn); setflags = (S == '1'); imm32 = ThumbExpandImm(i:imm3:imm8);
 if BadReg(d) || n == 15 then UNPREDICTABLE;

Encoding T4 ARMv6T2, ARMv7

SUBW<c> <Rd>, <Rn>, #<imm12>

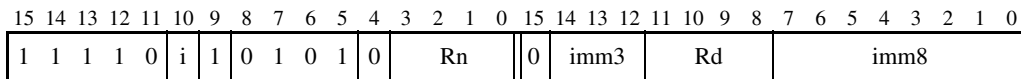

if Rn == '1111' then SEE ADR;
 if Rn == '1101' then SEE SUB (SP minus immediate);
 d = UInt(Rd); n = UInt(Rn); setflags = FALSE; imm32 = ZeroExtend(i:imm3:imm8, 32);
 if BadReg(d) then UNPREDICTABLE;

Assembler syntax

SUB{S}<C><Q> {<Rd>}, <Rn>, #<const> All encodings permitted
 SUBW<C><Q> {<Rd>}, <Rn>, #<const> Only encoding T4 permitted

where:

S If S is present, the instruction updates the flags. Otherwise, the flags are not updated.

<C><Q> See *Standard assembler syntax fields* on page A8-7.

<Rd> The destination register [1](#).

<Rn> The first operand register. If the SP is specified for <Rn>, see *SUB (SP minus immediate)* on page A8-426. If the PC is specified for <Rn>, see *ADR* on page A8-32.

<const> The immediate value to be subtracted from the value obtained from <Rn>. The range of values is 0-7 for encoding T1, 0-255 for encoding T2 and 0-4095 for encoding T4. See *Modified immediate constants in Thumb instructions* on page A6-17 for the range of values for encoding T3.

When multiple encodings of the same length are available for an instruction, encoding T3 is preferred to encoding T4 (if encoding T4 is required, use the SUBW syntax). Encoding T1 is preferred to encoding T2 if <Rd> is specified and encoding T2 is preferred to encoding T1 if <Rd> is omitted.

The pre-UAL syntax SUB<C>S is equivalent to SUBS<C>.

Operation

```
if ConditionPassed() then
    EncodingSpecificOperations();
    (result, carry, overflow) = AddWithCarry(R[n], NOT(imm32), '1');
    R[d] = result;
    if setflags then
        APSR.N = result<31>;
        APSR.Z = IsZeroBit(result);
        APSR.C = carry;
        APSR.V = overflow;
```

Exceptions

None.

A8.6.212 SUB (immediate, ARM)

This instruction subtracts an immediate value from a register value, and writes the result to the destination register. It can optionally update the condition flags based on the result.

Encoding A1 ARMv4*, ARMv5T*, ARMv6*, ARMv7

SUB{S}<C> <Rd>, <Rn>, #<const>

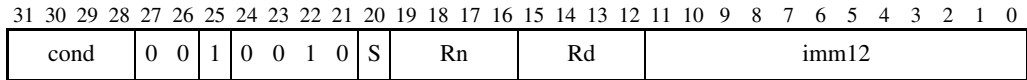

```

if Rn == '1111' && S == '0' then SEE ADR;
if Rn == '1101' then SEE SUB (SP minus immediate);
if Rd == '1111' && S == '1' then SEE SUBS PC, LR and related instructions;
d = UInt(Rd); n = UInt(Rn); setflags = (S == '1'); imm32 = ARMEExpandImm(imm12);
    
```

Assembler syntax

SUB{S}<C><Q> {<Rd>}, <Rn>, #<const>

where:

- S If S is present, the instruction updates the flags. Otherwise, the flags are not updated.
- <C><Q> See *Standard assembler syntax fields* on page A8-7.
- <Rd> The destination register.
- <Rn> The first operand register. If the SP is specified for <Rn>, see *SUB (SP minus immediate)* on page A8-426. If the PC is specified for <Rn>, see *ADR* on page A8-32.
- <const> The immediate value to be subtracted from the value obtained from <Rn>. See *Modified immediate constants in ARM instructions* on page A5-9 for the range of values.

The pre-UAL syntax SUB<C>S is equivalent to SUBS<C>.

Operation

```

if ConditionPassed() then
    EncodingSpecificOperations();
    (result, carry, overflow) = AddWithCarry(R[n], NOT(imm32), '1');
    if d == 15 then
        ALUWritePC(result); // setflags is always FALSE here
    else
        R[d] = result;
        if setflags then
            APSR.N = result<31>;
            APSR.Z = IsZeroBit(result);
            APSR.C = carry;
            APSR.V = overflow;

```

Exceptions

None.

A8.6.213 SUB (register)

This instruction subtracts an optionally-shifted register value from a register value, and writes the result to the destination register. It can optionally update the condition flags based on the result.

Encoding T1 ARMv4T, ARMv5T*, ARMv6*, ARMv7

SUBS <Rd>, <Rn>, <Rm> Outside IT block.

SUB<C> <Rd>, <Rn>, <Rm> Inside IT block.

15	14	13	12	11	10	9	8	7	6	5	4	3	2	1	0
0	0	0	1	1	0	1	Rm		Rn		Rd				

d = UInt(Rd); n = UInt(Rn); m = UInt(Rm); setflags = !InITBlock();
 (shift_t, shift_n) = (SRTYPE_LSL, 0);

Encoding T2 ARMv6T2, ARMv7

SUB{S}<C>.W <Rd>, <Rn>, <Rm>{, <shift>}

15	14	13	12	11	10	9	8	7	6	5	4	3	2	1	0	15	14	13	12	11	10	9	8	7	6	5	4	3	2	1	0
1	1	1	0	1	0	1	1	1	0	1	S	Rn		(0)	imm3	Rd	imm2	type	Rm												

if Rd == '1111' && S == '1' then SEE CMP (register);
 if Rn == '1101' then SEE SUB (SP minus register);
 d = UInt(Rd); n = UInt(Rn); m = UInt(Rm); setflags = (S == '1');
 (shift_t, shift_n) = DecodeImmShift(type, imm3:imm2);
 if BadReg(d) || n == 15 || BadReg(m) then UNPREDICTABLE;

Encoding A1 ARMv4*, ARMv5T*, ARMv6*, ARMv7

SUB{S}<C> <Rd>, <Rn>, <Rm>{, <shift>}

31	30	29	28	27	26	25	24	23	22	21	20	19	18	17	16	15	14	13	12	11	10	9	8	7	6	5	4	3	2	1	0
cond		0	0	0	0	0	1	0	S	Rn		Rd		imm5			type	0	Rm												

if Rd == '1111' && S == '1' then SEE SUBS PC, LR and related instructions;
 if Rn == '1101' then SEE SUB (SP minus register);
 d = UInt(Rd); n = UInt(Rn); m = UInt(Rm); setflags = (S == '1');
 (shift_t, shift_n) = DecodeImmShift(type, imm5);

Assembler syntax

SUB{S}<C><Q> {<Rd>}, <Rn>, <Rm> {,<shift>}

where:

S	If S is present, the instruction updates the flags. Otherwise, the flags are not updated.
<C><Q>	See <i>Standard assembler syntax fields</i> on page A8-7.
<Rd>	The destination register ↓
<Rn>	The first operand register. If the SP is specified for <Rn>, see <i>SUB (SP minus register)</i> on page A8-428 ↓
<Rm>	The register that is optionally shifted and used as the second operand ↓
<shift>	The shift to apply to the value read from <Rm>. If present, encoding T1 is not permitted. If absent, no shift is applied and all encodings are permitted. <i>Shifts applied to a register</i> on page A8-10 describes the shifts and how they are encoded.

The pre-UAL syntax SUB<C>S is equivalent to SUBS<C>.

Operation

```

if ConditionPassed() then
    EncodingSpecificOperations();
    shifted = Shift(R[m], shift_t, shift_n, APSR.C);
    (result, carry, overflow) = AddWithCarry(R[n], NOT(shifted), '1');
    if d == 15 then // Can only occur for ARM encoding
        ALUWritePC(result); // setflags is always FALSE here
    else
        R[d] = result;
        if setflags then
            APSR.N = result<31>;
            APSR.Z = IsZeroBit(result);
            APSR.C = carry;
            APSR.V = overflow;

```

Exceptions

None.

A8.6.214 SUB (register-shifted register)

This instruction subtracts a register-shifted register value from a register value, and writes the result to the destination register. It can optionally update the condition flags based on the result.

Encoding A1 ARMv4*, ARMv5T*, ARMv6*, ARMv7

SUB{S}<C> <Rd>, <Rn>, <Rm>, <type> <Rs>

31	30	29	28	27	26	25	24	23	22	21	20	19	18	17	16	15	14	13	12	11	10	9	8	7	6	5	4	3	2	1	0
cond		0	0	0	0	0	1	0	S	Rn				Rd				Rs				0	type		1	Rm					

```
d = UInt(Rd); n = UInt(Rn); m = UInt(Rm); s = UInt(Rs);
setflags = (S == '1'); shift_t = DecodeRegShift(type);
if d == 15 || n == 15 || m == 15 || s == 15 then UNPREDICTABLE;
```

Assembler syntax

SUB{S}<C><Q> {<Rd>}, <Rn>, <Rm>, <type> <Rs>

where:

S If S is present, the instruction updates the flags. Otherwise, the flags are not updated.

<C><Q> See *Standard assembler syntax fields* on page A8-7.

<Rd> The destination register.

<Rn> The first operand register.

<Rm> The register that is shifted and used as the second operand.

<type> The type of shift to apply to the value read from <Rm>. It must be one of:

ASR Arithmetic shift right, encoded as type = 0b10

LSL Logical shift left, encoded as type = 0b00

LSR Logical shift right, encoded as type = 0b01

ROR Rotate right, encoded as type = 0b11.

<Rs> The register whose bottom byte contains the amount to shift by.

The pre-UAL syntax SUB<C>S is equivalent to SUBS<C>.

Operation

```
if ConditionPassed() then
    EncodingSpecificOperations();
    shift_n = UInt(R[s]<7:0>);
    shifted = Shift(R[m], shift_t, shift_n, APSR.C);
    (result, carry, overflow) = AddWithCarry(R[n], NOT(shifted), '1');
    R[d] = result;
    if setflags then
        APSR.N = result<31>;
        APSR.Z = IsZeroBit(result);
        APSR.C = carry;
        APSR.V = overflow;
```

Exceptions

None.

A8.6.215 SUB (SP minus immediate)

This instruction subtracts an immediate value from the SP value, and writes the result to the destination register.

Encoding T1 ARMv4T, ARMv5T*, ARMv6*, ARMv7

SUB<c> SP,SP,#<imm>

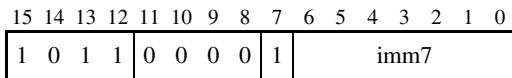

d = 13; setflags = FALSE; imm32 = ZeroExtend(imm7:'00', 32);

Encoding T2 ARMv6T2, ARMv7

SUB{S}<c>.W <Rd>,SP,#<const>

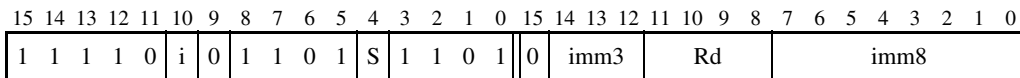

if Rd == '1111' && S == '1' then SEE CMP (immediate);
d = UInt(Rd); setflags = (S == '1'); imm32 = ThumbExpandImm(i:imm3:imm8);
if d == 15 then UNPREDICTABLE;

Encoding T3 ARMv6T2, ARMv7

SUBW<c> <Rd>,SP,#<imm12>

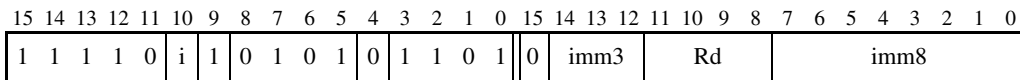

d = UInt(Rd); setflags = FALSE; imm32 = ZeroExtend(i:imm3:imm8, 32);
if d == 15 then UNPREDICTABLE;

Encoding A1 ARMv4*, ARMv5T*, ARMv6*, ARMv7

SUB{S}<c> <Rd>,SP,#<const>

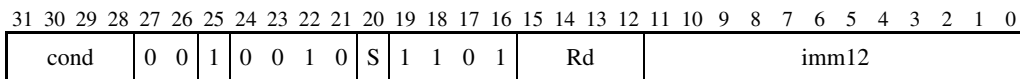

if Rd == '1111' && S == '1' then SEE SUBS PC, LR and related instructions;
d = UInt(Rd); setflags = (S == '1'); imm32 = ARMEExpandImm(imm12);

Assembler syntax

SUB{S}<C><q> {<Rd>}, SP, #<const> All encodings permitted
 SUBW<C><q> {<Rd>}, SP, #<const> Only encoding T3 permitted

where:

S If S is present, the instruction updates the flags. Otherwise, the flags are not updated.

<C><q> See *Standard assembler syntax fields* on page A8-7.

<Rd> The destination register. If omitted, <Rd> is SP.

<const> The immediate value to be subtracted from the value obtained from SP. Values are multiples of 4 in the range 0-508 for encoding T1 and any value in the range 0-4095 for encoding T3. See *Modified immediate constants in Thumb instructions* on page A6-17 or *Modified immediate constants in ARM instructions* on page A5-9 for the range of values for encodings T2 and A1.

When both 32-bit encodings are available for an instruction, encoding T2 is preferred to encoding T3 (if encoding T3 is required, use the SUBW syntax).

The pre-UAL syntax SUB<C>S is equivalent to SUBS<C>.

Operation

```
if ConditionPassed() then
    EncodingSpecificOperations();
    (result, carry, overflow) = AddWithCarry(SP, NOT(imm32), '1');
    if d == 15 then // Can only occur for ARM encoding
        ALUWritePC(result); // setflags is always FALSE here
    else
        R[d] = result;
        if setflags then
            APSR.N = result<31>;
            APSR.Z = IsZeroBit(result);
            APSR.C = carry;
            APSR.V = overflow;
```

Exceptions

None.

A8.6.216 SUB (SP minus register)

This instruction subtracts an optionally-shifted register value from the SP value, and writes the result to the destination register.

Encoding T1 ARMv6T2, ARMv7

SUB{S}<c> <Rd>,SP,<Rm>{,<shift>}

15	14	13	12	11	10	9	8	7	6	5	4	3	2	1	0	15	14	13	12	11	10	9	8	7	6	5	4	3	2	1	0
1	1	1	0	1	0	1	1	1	0	1	S	1	1	0	1	(0)	imm3			Rd			imm2		type		Rm				

```
d = UInt(Rd); m = UInt(Rm); setflags = (S == '1');
(shift_t, shift_n) = DecodeImmShift(type, imm3:imm2);
if d == 13 && (shift_t != SRTYPE_LSL || shift_n > 3) then UNPREDICTABLE;
if d == 15 || BadReg(m) then UNPREDICTABLE;
```

Encoding A1 ARMv4*, ARMv5T*, ARMv6*, ARMv7

SUB{S}<c> <Rd>,SP,<Rm>{,<shift>}

31	30	29	28	27	26	25	24	23	22	21	20	19	18	17	16	15	14	13	12	11	10	9	8	7	6	5	4	3	2	1	0
cond		0	0	0	0	0	1	0	S	1	1	0	1	Rd			imm5			type		0	Rm								

```
if Rd == '1111' && S == '1' then SEE SUBS PC, LR and related instructions;
d = UInt(Rd); m = UInt(Rm); setflags = (S == '1');
(shift_t, shift_n) = DecodeImmShift(type, imm5);
```

Assembler syntax

SUB{S}<C><Q> {<Rd>}, SP, <Rm> {,<shift>}

where:

- S If S is present, the instruction updates the flags. Otherwise, the flags are not updated.
- <C><Q> See *Standard assembler syntax fields* on page A8-7.
- <Rd> The destination register. If omitted, <Rd> is SP.
- <Rm> The register that is optionally shifted and used as the second operand.
- <shift> The shift to apply to the value read from <Rm>. If omitted, no shift is applied. *Shifts applied to a register* on page A8-10 describes the shifts and how they are encoded.

In the Thumb instruction set, if <Rd> is SP or omitted, <shift> is only permitted to be omitted, LSL #1, LSL #2, or LSL #3.

The pre-UAL syntax SUB<C>S is equivalent to SUBS<C>.

Operation

```

if ConditionPassed() then
    EncodingSpecificOperations();
    shifted = Shift(R[m], shift_t, shift_n, APSR.C);
    (result, carry, overflow) = AddWithCarry(SP, NOT(shifted), '1');
    if d == 15 then // Can only occur for ARM encoding
        ALUWritePC(result); // setflags is always FALSE here
    else
        R[d] = result;
        if setflags then
            APSR.N = result<31>;
            APSR.Z = IsZeroBit(result);
            APSR.C = carry;
            APSR.V = overflow;

```

Exceptions

None.

A8.6.217 SUBS PC, LR and related instructions

These instructions are for system level use only. See *SUBS PC, LR and related instructions* on page B6-25.

A8.6.218 SVC (previously SWI)

Supervisor Call, previously called a Software Interrupt. For more information, see *Exceptions* on page B1-30, and in particular *Supervisor Call (SVC) exception* on page B1-52.

You can use this instruction as a call to an operating system to provide a service.

Encoding T1 ARMv4T, ARMv5T*, ARMv6*, ARMv7

SVC<c> #<imm8>

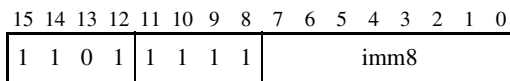

imm32 = ZeroExtend(imm8, 32);

// imm32 is for assembly/disassembly, and is ignored by hardware. SVC handlers in some
// systems interpret imm8 in software, for example to determine the required service.

Encoding A1 ARMv4*, ARMv5T*, ARMv6*, ARMv7

SVC<c> #<imm24>

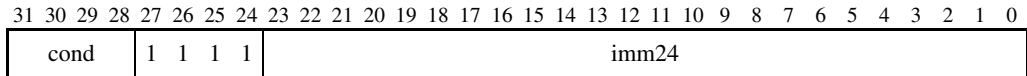

imm32 = ZeroExtend(imm24, 32);

// imm32 is for assembly/disassembly, and is ignored by hardware. SVC handlers in some
// systems interpret imm24 in software, for example to determine the required service.

Assembler syntax

SVC<c><q> #<imm>

where:

<c><q> See *Standard assembler syntax fields* on page A8-7.

<imm> Specifies an immediate constant, 8-bit in Thumb code, or 24-bit in ARM code.

The pre-UAL syntax SWI<c> is equivalent to SVC<c>.

Operation

```
if ConditionPassed() then
    EncodingSpecificOperations();
    CallSupervisor();
```

Exceptions

Supervisor Call.

A8.6.219 SWP, SWPB

SWP (Swap) swaps a word between registers and memory. SWP loads a word from the memory address given by the value of register <Rn>. The value of register <Rt2> is then stored to the memory address given by the value of <Rn>, and the original loaded value is written to register <Rt>. If the same register is specified for <Rt> and <Rt2>, this instruction swaps the value of the register and the value at the memory address.

SWPB (Swap Byte) swaps a byte between registers and memory. SWPB loads a byte from the memory address given by the value of register <Rn>. The value of the least significant byte of register <Rt2> is stored to the memory address given by <Rn>, the original loaded value is zero-extended to a 32-bit word, and the word is written to register <Rt>. If the same register is specified for <Rt> and <Rt2>, this instruction swaps the value of the least significant byte of the register and the byte value at the memory address, and clears the most significant three bytes of the register.

For both instructions, the memory system ensures that no other memory access can occur to the memory location between the load access and the store access.

————— **Note** —————

- The SWP and SWPB instructions rely on the properties of the system beyond the processor to ensure that no stores from other observers can occur between the load access and the store access, and this might not be implemented for all regions of memory on some system implementations. In all cases, SWP and SWPB do ensure that no stores from the processor that executed the SWP or SWPB instruction can occur between the load access and the store access of the SWP or SWPB.
- The use of SWP is deprecated, and new code should use LDREX/STREX in preference to using SWP.
- The use of SWPB is deprecated, and new code should use LDREXB/STREXB in preference to using SWPB.

Encoding A1 ARMv4*, ARMv5T*, ARMv6* (deprecated), ARMv7 (deprecated)

SWP{B}<C> <Rt>, <Rt2>, [<Rn>]

31	30	29	28	27	26	25	24	23	22	21	20	19	18	17	16	15	14	13	12	11	10	9	8	7	6	5	4	3	2	1	0
cond				0	0	0	1	0	B	0	0	Rn				Rt				(0)	(0)	(0)	(0)	1	0	0	1	Rt2			

t = UInt(Rt); t2 = UInt(Rt2); n = UInt(Rn); size = if B == '1' then 1 else 4;
 if t == 15 || t2 == 15 || n == 15 || n == t || n == t2 then UNPREDICTABLE;

Assembler syntax

SWP{B}<C><q> <Rt>, <Rt2>, [<Rn>]

where:

<C><q> See *Standard assembler syntax fields* on page A8-7.

<Rt> The destination register.

<Rt2> Contains the value that is stored to memory.

<Rn> Contains the memory address to load from.

Operation

```

if ConditionPassed() then
    EncodingSpecificOperations();
    // The MemA[] accesses in the next two statements are locked together, that is, the memory
    // system must ensure that no other access to the same location can occur between them.
    data = MemA[R[n], size];
    MemA[R[n], size] = R[t2]<8*size-1:0>;
    if size == 1 then // SWPB
        R[t] = ZeroExtend(data, 32);
    else // SWP
        // Rotation in the following will always be by zero in ARMv7, due to alignment checks,
        // but can be nonzero in legacy configurations.
        R[t] = ROR(data, 8*UInt(address<1:0>));

```

Exceptions

Data Abort.

A8.6.220 SXTAB

Signed Extend and Add Byte extracts an 8-bit value from a register, sign-extends it to 32 bits, adds the result to the value in another register, and writes the final result to the destination register. You can specify a rotation by 0, 8, 16, or 24 bits before extracting the 8-bit value.

Encoding T1 ARMv6T2, ARMv7

SXTAB<c> <Rd>, <Rn>, <Rm>{, <rotation>}

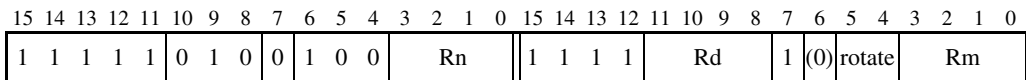

if Rn == '1111' then SEE SXTB;
d = UInt(Rd); n = UInt(Rn); m = UInt(Rm); rotation = UInt(rotate:'000');
if BadReg(d) || n == 13 || BadReg(m) then UNPREDICTABLE;

Encoding A1 ARMv6*, ARMv7

SXTAB<c> <Rd>, <Rn>, <Rm>{, <rotation>}

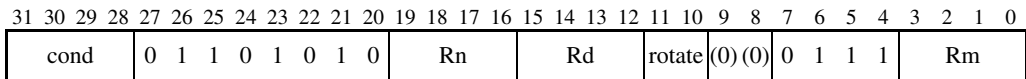

if Rn == '1111' then SEE SXTB;
d = UInt(Rd); n = UInt(Rn); m = UInt(Rm); rotation = UInt(rotate:'000');
if d == 15 || m == 15 then UNPREDICTABLE;

Assembler syntax

SXTAB<c><q> {<Rd>,<Rn>, <Rm> {, <rotation>}

where:

<c><q> See *Standard assembler syntax fields* on page A8-7.

<Rd> The destination register.

<Rn> The first operand register.

<Rm> The second operand register.

<rotation> This can be any one of:

omitted encoded as rotate = '00'
 ROR #8 encoded as rotate = '01'
 ROR #16 encoded as rotate = '10'
 ROR #24 encoded as rotate = '11'.

————— Note —————

An assembler can permit ROR #0 to mean the same thing as omitting the rotation, possibly with restrictions on the permitted encodings, but this is not standard UAL and must not be used for disassembly.

Operation

```
if ConditionPassed() then
    EncodingSpecificOperations();
    rotated = ROR(R[m], rotation);
    R[d] = R[n] + SignExtend(rotated<7:0>, 32);
```

Exceptions

None.

A8.6.221 SXTAB16

Signed Extend and Add Byte 16 extracts two 8-bit values from a register, sign-extends them to 16 bits each, adds the results to two 16-bit values from another register, and writes the final results to the destination register. You can specify a rotation by 0, 8, 16, or 24 bits before extracting the 8-bit values.

Encoding T1 ARMv6T2, ARMv7

SXTAB16<c> <Rd>, <Rn>, <Rm>{, <rotation>}

15	14	13	12	11	10	9	8	7	6	5	4	3	2	1	0	15	14	13	12	11	10	9	8	7	6	5	4	3	2	1	0
1	1	1	1	1	0	1	0	0	0	1	0	Rn				1	1	1	1	Rd				1	(0)	rotate	Rm				

if Rn == '1111' then SEE SXTB16;
d = UInt(Rd); n = UInt(Rn); m = UInt(Rm); rotation = UInt(rotate:'000');
if BadReg(d) || n == 13 || BadReg(m) then UNPREDICTABLE;

Encoding A1 ARMv6*, ARMv7

SXTAB16<c> <Rd>, <Rn>, <Rm>{, <rotation>}

31	30	29	28	27	26	25	24	23	22	21	20	19	18	17	16	15	14	13	12	11	10	9	8	7	6	5	4	3	2	1	0
cond		0	1	1	0	1	0	0	0	Rn				Rd				rotate	(0)	(0)	0	1	1	1	Rm						

if Rn == '1111' then SEE SXTB16;
d = UInt(Rd); n = UInt(Rn); m = UInt(Rm); rotation = UInt(rotate:'000');
if d == 15 || m == 15 then UNPREDICTABLE;

Assembler syntax

SXTAB16<c><q> {<Rd>,<Rn>, <Rm> {, <rotation>}

where:

<c><q> See *Standard assembler syntax fields* on page A8-7.

<Rd> The destination register.

<Rn> The first operand register.

<Rm> The second operand register.

<rotation> This can be any one of:

omitted encoded as rotate = '00'
 ROR #8 encoded as rotate = '01'
 ROR #16 encoded as rotate = '10'
 ROR #24 encoded as rotate = '11'.

————— Note —————

An assembler can permit ROR #0 to mean the same thing as omitting the rotation, possibly with restrictions on the permitted encodings, but this is not standard UAL and must not be used for disassembly.

Operation

```
if ConditionPassed() then
    EncodingSpecificOperations();
    rotated = ROR(R[m], rotation);
    R[d]<15:0> = R[n]<15:0> + SignExtend(rotated<7:0>, 16);
    R[d]<31:16> = R[n]<31:16> + SignExtend(rotated<23:16>, 16);
```

Exceptions

None.

A8.6.222 SXTAH

Signed Extend and Add Halfword extracts a 16-bit value from a register, sign-extends it to 32 bits, adds the result to a value from another register, and writes the final result to the destination register. You can specify a rotation by 0, 8, 16, or 24 bits before extracting the 16-bit value.

Encoding T1 ARMv6T2, ARMv7

SXTAH<c> <Rd>, <Rn>, <Rm>{, <rotation>}

15	14	13	12	11	10	9	8	7	6	5	4	3	2	1	0	15	14	13	12	11	10	9	8	7	6	5	4	3	2	1	0
1	1	1	1	1	0	1	0	0	0	0	0	Rn				1	1	1	1	Rd				1	(0)	rotate	Rm				

if Rn == '1111' then SEE SXTH;

d = UInt(Rd); n = UInt(Rn); m = UInt(Rm); rotation = UInt(rotate:'000');

if BadReg(d) || n == 13 || BadReg(m) then UNPREDICTABLE;

Encoding A1 ARMv6*, ARMv7

SXTAH<c> <Rd>, <Rn>, <Rm>{, <rotation>}

31	30	29	28	27	26	25	24	23	22	21	20	19	18	17	16	15	14	13	12	11	10	9	8	7	6	5	4	3	2	1	0
cond		0	1	1	0	1	0	1	1	Rn				Rd				rotate	(0)	(0)	0	1	1	1	Rm						

if Rn == '1111' then SEE SXTH;

d = UInt(Rd); n = UInt(Rn); m = UInt(Rm); rotation = UInt(rotate:'000');

if d == 15 || m == 15 then UNPREDICTABLE;

Assembler syntax

SXTAH<c><q> {<Rd>,<Rn>, <Rm> {, <rotation>}

where:

<c><q> See *Standard assembler syntax fields* on page A8-7.

<Rd> The destination register.

<Rn> The first operand register.

<Rm> The second operand register.

<rotation> This can be any one of:
omitted encoded as rotate = '00'
 ROR #8 encoded as rotate = '01'
 ROR #16 encoded as rotate = '10'
 ROR #24 encoded as rotate = '11'.

————— Note —————

An assembler can permit ROR #0 to mean the same thing as omitting the rotation, possibly with restrictions on the permitted encodings, but this is not standard UAL and must not be used for disassembly.

Operation

```
if ConditionPassed() then
    EncodingSpecificOperations();
    rotated = ROR(R[m], rotation);
    R[d] = R[n] + SignExtend(rotated<15:0>, 32);
```

Exceptions

None.

A8.6.223 SXTB

Signed Extend Byte extracts an 8-bit value from a register, sign-extends it to 32 bits, and writes the result to the destination register. You can specify a rotation by 0, 8, 16, or 24 bits before extracting the 8-bit value.

Encoding T1 ARMv6*, ARMv7

SXTB<c> <Rd>, <Rm>

15	14	13	12	11	10	9	8	7	6	5	4	3	2	1	0
1	0	1	1	0	0	1	0	0	1	Rm	Rd				

d = UInt(Rd); m = UInt(Rm); rotation = 0;

Encoding T2 ARMv6T2, ARMv7

SXTB<c>.W <Rd>, <Rm>{, <rotation>}

15	14	13	12	11	10	9	8	7	6	5	4	3	2	1	0	15	14	13	12	11	10	9	8	7	6	5	4	3	2	1	0
1	1	1	1	1	0	1	0	0	1	0	0	1	1	1	1	1	1	1	1	Rd	1	(0)	rotate	Rm							

d = UInt(Rd); m = UInt(Rm); rotation = UInt(rotate:'000');
 if BadReg(d) || BadReg(m) then UNPREDICTABLE;

Encoding A1 ARMv6*, ARMv7

SXTB<c> <Rd>, <Rm>{, <rotation>}

31	30	29	28	27	26	25	24	23	22	21	20	19	18	17	16	15	14	13	12	11	10	9	8	7	6	5	4	3	2	1	0
cond		0	1	1	0	1	0	1	0	1	0	1	1	1	1	Rd	rotate	(0)	(0)	0	1	1	1	Rm							

d = UInt(Rd); m = UInt(Rm); rotation = UInt(rotate:'000');
 if d == 15 || m == 15 then UNPREDICTABLE;

Assembler syntax

SXTB<c><q> {<Rd>}, <Rm> {, <rotation>}

where:

<c><q> See *Standard assembler syntax fields* on page A8-7.

<Rd> The destination register.

<Rm> The register that contains the operand.

<rotation> This can be any one of:

omitted any encoding, with rotate = '00' in encoding T2 or A1

ROR #8 encoding T2 or A1, rotate = '01'

ROR #16 encoding T2 or A1, rotate = '10'

ROR #24 encoding T2 or A1, rotate = '11'

Note

An assembler can permit ROR #0 to mean the same thing as omitting the rotation, possibly with restrictions on the permitted encodings, but this is not standard UAL and must not be used for disassembly.

Operation

```
if ConditionPassed() then
    EncodingSpecificOperations();
    rotated = ROR(R[m], rotation);
    R[d] = SignExtend(rotated<7:0>, 32);
```

Exceptions

None.

A8.6.224 SXTB16

Signed Extend Byte 16 extracts two 8-bit values from a register, sign-extends them to 16 bits each, and writes the results to the destination register. You can specify a rotation by 0, 8, 16, or 24 bits before extracting the 8-bit values.

Encoding T1 ARMv6T2, ARMv7

SXTB16<c> <Rd>, <Rm>{, <rotation>}

15	14	13	12	11	10	9	8	7	6	5	4	3	2	1	0	15	14	13	12	11	10	9	8	7	6	5	4	3	2	1	0
1	1	1	1	1	0	1	0	0	0	1	0	1	1	1	1	1	1	1	1				Rd	1	(0)	rotate		Rm			

d = UInt(Rd); m = UInt(Rm); rotation = UInt(rotate:'000');
 if BadReg(d) || BadReg(m) then UNPREDICTABLE;

Encoding A1 ARMv6*, ARMv7

SXTB16<c> <Rd>, <Rm>{, <rotation>}

31	30	29	28	27	26	25	24	23	22	21	20	19	18	17	16	15	14	13	12	11	10	9	8	7	6	5	4	3	2	1	0
cond		0	1	1	0	1	0	0	0	1	1	1	1				Rd		rotate	(0)	(0)		0	1	1	1			Rm		

d = UInt(Rd); m = UInt(Rm); rotation = UInt(rotate:'000');
 if d == 15 || m == 15 then UNPREDICTABLE;

Assembler syntax

SXTB16<c><q> {<Rd>}, <Rm> {, <rotation>}

where:

<c><q> See *Standard assembler syntax fields* on page A8-7.

<Rd> The destination register.

<Rm> The register that contains the operand.

<rotation> This can be any one of:

omitted encoded as rotate = '00'
 ROR #8 encoded as rotate = '01'
 ROR #16 encoded as rotate = '10'
 ROR #24 encoded as rotate = '11'.

Note

An assembler can permit ROR #0 to mean the same thing as omitting the rotation, possibly with restrictions on the permitted encodings, but this is not standard UAL and must not be used for disassembly.

Operation

```
if ConditionPassed() then
    EncodingSpecificOperations();
    rotated = ROR(R[m], rotation);
    R[d]<15:0> = SignExtend(rotated<7:0>, 16);
    R[d]<31:16> = SignExtend(rotated<23:16>, 16);
```

Exceptions

None.

A8.6.225 SXTB

Signed Extend Halfword extracts a 16-bit value from a register, sign-extends it to 32 bits, and writes the result to the destination register. You can specify a rotation by 0, 8, 16, or 24 bits before extracting the 16-bit value.

Encoding T1 ARMv6*, ARMv7

SXTB<c> <Rd>, <Rm>

15	14	13	12	11	10	9	8	7	6	5	4	3	2	1	0
1	0	1	1	0	0	1	0	0	0	Rm				Rd	

d = UInt(Rd); m = UInt(Rm); rotation = 0;

Encoding T2 ARMv6T2, ARMv7

SXTB<c>.W <Rd>, <Rm>{, <rotation>}

15	14	13	12	11	10	9	8	7	6	5	4	3	2	1	0	15	14	13	12	11	10	9	8	7	6	5	4	3	2	1	0
1	1	1	1	1	0	1	0	0	0	0	0	1	1	1	1	1	1	1	1	Rd	1	(0)	rotate	Rm							

d = UInt(Rd); m = UInt(Rm); rotation = UInt(rotate:'000');
 if BadReg(d) || BadReg(m) then UNPREDICTABLE;

Encoding A1 ARMv6*, ARMv7

SXTB<c> <Rd>, <Rm>{, <rotation>}

31	30	29	28	27	26	25	24	23	22	21	20	19	18	17	16	15	14	13	12	11	10	9	8	7	6	5	4	3	2	1	0
cond		0	1	1	0	1	0	1	1	1	1	1	Rd	rotate	(0)	(0)	0	1	1	1	Rm										

d = UInt(Rd); m = UInt(Rm); rotation = UInt(rotate:'000');
 if d == 15 || m == 15 then UNPREDICTABLE;

Assembler syntax

SXTH<c><q> {<Rd>}, <Rm> {, <rotation>}

where:

<c><q> See *Standard assembler syntax fields* on page A8-7.

<Rd> The destination register.

<Rm> The register that contains the operand.

<rotation> This can be any one of:

omitted any encoding, with rotate = '00' in encoding T2 or A1

ROR #8 encoding T2 or A1, rotate = '01'

ROR #16 encoding T2 or A1, rotate = '10'

ROR #24 encoding T2 or A1, rotate = '11'

Note

An assembler can permit ROR #0 to mean the same thing as omitting the rotation, possibly with restrictions on the permitted encodings, but this is not standard UAL and must not be used for disassembly.

Operation

```
if ConditionPassed() then
    EncodingSpecificOperations();
    rotated = ROR(R[m], rotation);
    R[d] = SignExtend(rotated<15:0>, 32);
```

Exceptions

None.

A8.6.226 TBB, TBH

Table Branch Byte causes a PC-relative forward branch using a table of single byte offsets. A base register provides a pointer to the table, and a second register supplies an index into the table. The branch length is twice the value of the byte returned from the table.

Table Branch Halfword causes a PC-relative forward branch using a table of single halfword offsets. A base register provides a pointer to the table, and a second register supplies an index into the table. The branch length is twice the value of the halfword returned from the table.

Encoding T1 ARMv6T2, ARMv7

TBB<c> [<Rn>, <Rm>] Outside or last in IT block

TBH<c> [<Rn>, <Rm>, LSL #1] Outside or last in IT block

15	14	13	12	11	10	9	8	7	6	5	4	3	2	1	0	15	14	13	12	11	10	9	8	7	6	5	4	3	2	1	0
1	1	1	0	1	0	0	0	1	1	0	1	Rn				(1) (1) (1) (1)				(0) (0) (0) (0)				0 0 0			H	Rm			

```
n = UInt(Rn); m = UInt(Rm); is_tbh = (H == '1');
if n == 13 || BadReg(m) then UNPREDICTABLE;
if InITBlock() && !LastInITBlock() then UNPREDICTABLE;
```

Assembler syntax

TBB<C><q> [<Rn>, <Rm>]

TBH<C><q> [<Rn>, <Rm>, LSL #1]

where:

<C><q> See *Standard assembler syntax fields* on page A8-7.

<Rn> The base register. This contains the address of the table of branch lengths. The PC can be used. If it is, the table immediately follows this instruction.

<Rm> The index register.

For TBB, this contains an integer pointing to a single byte in the table. The offset in the table is the value of the index.

For TBH, this contains an integer pointing to a halfword in the table. The offset in the table is twice the value of the index.

Operation

```
if ConditionPassed() then
    EncodingSpecificOperations(); NullCheckIfThumbEE(n);
    if is_tbh then
        halfwords = UInt(MemU[R[n]+LSL(R[m],1), 2]);
    else
        halfwords = UInt(MemU[R[n]+R[m], 1]);
    BranchWritePC(PC + 2*halfwords);
```

Exceptions

Data Abort.

A8.6.227 TEQ (immediate)

Test Equivalence (immediate) performs a bitwise exclusive OR operation on a register value and an immediate value. It updates the condition flags based on the result, and discards the result.

Encoding T1 ARMv6T2, ARMv7

TEQ<C> <Rn>, #<const>

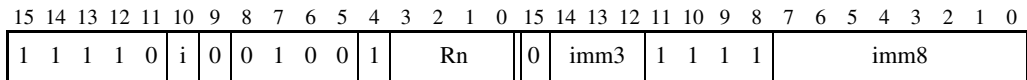

```
n = UInt(Rn);
(imm32, carry) = ThumbExpandImm_C(i:imm3:imm8, APSR.C);
if BadReg(n) then UNPREDICTABLE;
```

Encoding A1 ARMv4*, ARMv5T*, ARMv6*, ARMv7

TEQ<C> <Rn>, #<const>

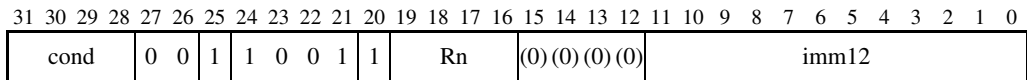

```
n = UInt(Rn);
(imm32, carry) = ARMEExpandImm_C(imm12, APSR.C);
```

Assembler syntax

TEQ<C><Q> <Rn>, #<const>

where:

<C><Q> See *Standard assembler syntax fields* on page A8-7.

<Rn> The operand register [1](#).

<const> The immediate value to be tested against the value obtained from <Rn>. See *Modified immediate constants in Thumb instructions* on page A6-17 or *Modified immediate constants in ARM instructions* on page A5-9 for the range of values.

Operation

```
if ConditionPassed() then
    EncodingSpecificOperations();
    result = R[n] EOR imm32;
    APSR.N = result<31>;
    APSR.Z = IsZeroBit(result);
    APSR.C = carry;
    // APSR.V unchanged
```

Exceptions

None.

A8.6.228 TEQ (register)

Test Equivalence (register) performs a bitwise exclusive OR operation on a register value and an optionally-shifted register value. It updates the condition flags based on the result, and discards the result.

Encoding T1 ARMv6T2, ARMv7

TEQ<C> <Rn>, <Rm>{, <shift>}

15	14	13	12	11	10	9	8	7	6	5	4	3	2	1	0	15	14	13	12	11	10	9	8	7	6	5	4	3	2	1	0
1	1	1	0	1	0	1	0	1	0	0	1	Rn				(0)	imm3			1	1	1	1	imm2		type	Rm				

```
n = UInt(Rn); m = UInt(Rm);
(shift_t, shift_n) = DecodeImmShift(type, imm3:imm2);
if BadReg(n) || BadReg(m) then UNPREDICTABLE;
```

Encoding A1 ARMv4*, ARMv5T*, ARMv6*, ARMv7

TEQ<C> <Rn>, <Rm>{, <shift>}

31	30	29	28	27	26	25	24	23	22	21	20	19	18	17	16	15	14	13	12	11	10	9	8	7	6	5	4	3	2	1	0
cond			0	0	0	1	0	0	1	1	Rn				(0)	(0)	(0)	(0)	imm5				type	0	Rm						

```
n = UInt(Rn); m = UInt(Rm);
(shift_t, shift_n) = DecodeImmShift(type, imm5);
```

Assembler syntax

TEQ<c><q> <Rn>, <Rm> {,<shift>}

where:

<c><q> See *Standard assembler syntax fields* on page A8-7.

<Rn> The first operand register [↓](#)

<Rm> The register that is optionally shifted and used as the second operand [↓](#)

<shift> The shift to apply to the value read from <Rm>. If omitted, no shift is applied. *Shifts applied to a register* on page A8-10 describes the shifts and how they are encoded.

Operation

```
if ConditionPassed() then
    EncodingSpecificOperations();
    (shifted, carry) = Shift_C(R[m], shift_t, shift_n, APSR.C);
    result = R[n] EOR shifted;
    APSR.N = result<31>;
    APSR.Z = IsZeroBit(result);
    APSR.C = carry;
    // APSR.V unchanged
```

Exceptions

None.

A8.6.229 TEQ (register-shifted register)

Test Equivalence (register-shifted register) performs a bitwise exclusive OR operation on a register value and a register-shifted register value. It updates the condition flags based on the result, and discards the result.

Encoding A1 ARMv4*, ARMv5T*, ARMv6*, ARMv7

TEQ<c> <Rn>, <Rm>, <type> <Rs>

31 30 29 28 27 26 25 24 23 22 21 20 19 18 17 16 15 14 13 12 11 10 9 8 7 6 5 4 3 2 1 0																															
cond			0	0	0	1 0 0 1			1	Rn				(0)(0)(0)(0)				Rs		0	type		1	Rm							

```
n = UInt(Rn); m = UInt(Rm); s = UInt(Rs);
shift_t = DecodeRegShift(type);
if n == 15 || m == 15 || s == 15 then UNPREDICTABLE;
```

Assembler syntax

TEQ<c><q> <Rn>, <Rm>, <type> <Rs>

where:

<c><q>	See <i>Standard assembler syntax fields</i> on page A8-7.
<Rn>	The first operand register.
<Rm>	The register that is shifted and used as the second operand.
<type>	The type of shift to apply to the value read from <Rm>. It must be one of: ASR Arithmetic shift right, encoded as type = 0b10 LSL Logical shift left, encoded as type = 0b00 LSR Logical shift right, encoded as type = 0b01 ROR Rotate right, encoded as type = 0b11.
<Rs>	The register whose bottom byte contains the amount to shift by.

Operation

```

if ConditionPassed() then
    EncodingSpecificOperations();
    shift_n = UInt(R[s]<7:0>);
    (shifted, carry) = Shift_C(R[m], shift_t, shift_n, APSR.C);
    result = R[n] EOR shifted;
    APSR.N = result<31>;
    APSR.Z = IsZeroBit(result);
    APSR.C = carry;
    // APSR.V unchanged

```

Exceptions

None.

A8.6.230 TST (immediate)

Test (immediate) performs a bitwise AND operation on a register value and an immediate value. It updates the condition flags based on the result, and discards the result.

Encoding T1 ARMv6T2, ARMv7

TST<C> <Rn>, #<const>

15	14	13	12	11	10	9	8	7	6	5	4	3	2	1	0	15	14	13	12	11	10	9	8	7	6	5	4	3	2	1	0
1	1	1	1	0	i	0	0	0	0	0	1	Rn				0	imm3			1	1	1	1	imm8							

```
n = UInt(Rn);
(imm32, carry) = ThumbExpandImm_C(i:imm3:imm8, APSR.C);
if BadReg(n) then UNPREDICTABLE;
```

Encoding A1 ARMv4*, ARMv5T*, ARMv6*, ARMv7

TST<C> <Rn>, #<const>

31	30	29	28	27	26	25	24	23	22	21	20	19	18	17	16	15	14	13	12	11	10	9	8	7	6	5	4	3	2	1	0
cond		0	0	1	1	0	0	0	1	Rn				(0)	(0)	(0)	(0)	imm12													

```
n = UInt(Rn);
(imm32, carry) = ARMEExpandImm_C(imm12, APSR.C);
```

Assembler syntax

TST<c><q> <Rn>, #<const>

where:

<c><q> See *Standard assembler syntax fields* on page A8-7.

<Rn> The operand register [1](#).

<const> The immediate value to be tested against the value obtained from <Rn>. See *Modified immediate constants in Thumb instructions* on page A6-17 or *Modified immediate constants in ARM instructions* on page A5-9 for the range of values.

Operation

```
if ConditionPassed() then
    EncodingSpecificOperations();
    result = R[n] AND imm32;
    APSR.N = result<31>;
    APSR.Z = IsZeroBit(result);
    APSR.C = carry;
    // APSR.V unchanged
```

Exceptions

None.

A8.6.231 TST (register)

Test (register) performs a bitwise AND operation on a register value and an optionally-shifted register value. It updates the condition flags based on the result, and discards the result.

Encoding T1 ARMv4T, ARMv5T*, ARMv6*, ARMv7

TST<c> <Rn>, <Rm>

15	14	13	12	11	10	9	8	7	6	5	4	3	2	1	0
0	1	0	0	0	0	1	0	0	0	Rm				Rn	

n = UInt(Rdn); m = UInt(Rm);
 (shift_t, shift_n) = (SRTYPE_LSL, 0);

Encoding T2 ARMv6T2, ARMv7

TST<c>.W <Rn>, <Rm>{, <shift>}

15	14	13	12	11	10	9	8	7	6	5	4	3	2	1	0	15	14	13	12	11	10	9	8	7	6	5	4	3	2	1	0
1	1	1	0	1	0	1	0	0	0	0	1	Rn	(0)	imm3	1	1	1	1	imm2	type				Rm							

n = UInt(Rn); m = UInt(Rm);
 (shift_t, shift_n) = DecodeImmShift(type, imm3:imm2);
 if BadReg(n) || BadReg(m) then UNPREDICTABLE;

Encoding A1 ARMv4*, ARMv5T*, ARMv6*, ARMv7

TST<c> <Rn>, <Rm>{, <shift>}

31	30	29	28	27	26	25	24	23	22	21	20	19	18	17	16	15	14	13	12	11	10	9	8	7	6	5	4	3	2	1	0
cond	0	0	0	1	0	0	0	1	Rn	(0)	(0)	(0)	(0)	imm5	type	0															Rm

n = UInt(Rn); m = UInt(Rm);
 (shift_t, shift_n) = DecodeImmShift(type, imm5);

Assembler syntax

TST<C><Q> <Rn>, <Rm> {,<shift>}

where:

<C><Q> See *Standard assembler syntax fields* on page A8-7.

<Rn> The first operand register [↓](#)

<Rm> The register that is optionally shifted and used as the second operand [↓](#)

<shift> The shift to apply to the value read from <Rm>. If present, encoding T1 is not permitted. If absent, no shift is applied and all encodings are permitted. *Shifts applied to a register* on page A8-10 describes the shifts and how they are encoded.

Operation

```
if ConditionPassed() then
    EncodingSpecificOperations();
    (shifted, carry) = Shift_C(R[m], shift_t, shift_n, APSR.C);
    result = R[n] AND shifted;
    APSR.N = result<31>;
    APSR.Z = IsZeroBit(result);
    APSR.C = carry;
    // APSR.V unchanged
```

Exceptions

None.

A8.6.232 TST (register-shifted register)

Test (register-shifted register) performs a bitwise AND operation on a register value and a register-shifted register value. It updates the condition flags based on the result, and discards the result.

Encoding A1 ARMv4*, ARMv5T*, ARMv6*, ARMv7

TST<c> <Rn>, <Rm>, <type> <Rs>

31	30	29	28	27	26	25	24	23	22	21	20	19	18	17	16	15	14	13	12	11	10	9	8	7	6	5	4	3	2	1	0
cond			0	0	0	1	0	0	0	1	Rn				(0)	(0)	(0)	(0)	Rs		0	type		1	Rm						

```
n = UInt(Rn); m = UInt(Rm); s = UInt(Rs);
shift_t = DecodeRegShift(type);
if n == 15 || m == 15 || s == 15 then UNPREDICTABLE;
```

Assembler syntax

TST<c><q> <Rn>, <Rm>, <type> <Rs>

where:

<c><q>	See <i>Standard assembler syntax fields</i> on page A8-7.
<Rn>	The first operand register.
<Rm>	The register that is shifted and used as the second operand.
<type>	The type of shift to apply to the value read from <Rm>. It must be one of: <ul style="list-style-type: none"> ASR Arithmetic shift right, encoded as type = 0b10 LSL Logical shift left, encoded as type = 0b00 LSR Logical shift right, encoded as type = 0b01 ROR Rotate right, encoded as type = 0b11.
<Rs>	The register whose bottom byte contains the amount to shift by.

Operation

```

if ConditionPassed() then
    EncodingSpecificOperations();
    shift_n = UInt(R[s]<7:0>);
    (shifted, carry) = Shift_C(R[m], shift_t, shift_n, APSR.C);
    result = R[n] AND shifted;
    APSR.N = result<31>;
    APSR.Z = IsZeroBit(result);
    APSR.C = carry;
    // APSR.V unchanged
  
```

Exceptions

None.

A8.6.233 UADD16

Unsigned Add 16 performs two 16-bit unsigned integer additions, and writes the results to the destination register. It sets the APSR.GE bits according to the results of the additions.

Encoding T1 ARMv6T2, ARMv7

UADD16<c> <Rd>, <Rn>, <Rm>

15	14	13	12	11	10	9	8	7	6	5	4	3	2	1	0	15	14	13	12	11	10	9	8	7	6	5	4	3	2	1	0
1	1	1	1	1	0	1	0	1	0	0	1	Rn				1	1	1	1	Rd				0	1	0	0	Rm			

d = UInt(Rd); n = UInt(Rn); m = UInt(Rm);
 if BadReg(d) || BadReg(n) || BadReg(m) then UNPREDICTABLE;

Encoding A1 ARMv6*, ARMv7

UADD16<c> <Rd>, <Rn>, <Rm>

31	30	29	28	27	26	25	24	23	22	21	20	19	18	17	16	15	14	13	12	11	10	9	8	7	6	5	4	3	2	1	0	
cond		0	1	1	0	0	1	0	1	Rn				Rd				(1)	(1)	(1)	(1)	0				0	0	1	Rm			

d = UInt(Rd); n = UInt(Rn); m = UInt(Rm);
 if d == 15 || n == 15 || m == 15 then UNPREDICTABLE;

Assembler syntax

UADD16<c><q> {<Rd>}, <Rn>, <Rm>

where:

<c><q> See *Standard assembler syntax fields* on page A8-7.

<Rd> The destination register.

<Rn> The first operand register.

<Rm> The second operand register.

Operation

```

if ConditionPassed() then
    EncodingSpecificOperations();
    sum1 = UInt(R[n]<15:0>) + UInt(R[m]<15:0>);
    sum2 = UInt(R[n]<31:16>) + UInt(R[m]<31:16>);
    R[d]<15:0> = sum1<15:0>;
    R[d]<31:16> = sum2<15:0>;
    APSR.GE<1:0> = if sum1 >= 0x10000 then '11' else '00';
    APSR.GE<3:2> = if sum2 >= 0x10000 then '11' else '00';

```

Exceptions

None.

A8.6.234 UADD8

Unsigned Add 8 performs four unsigned 8-bit integer additions, and writes the results to the destination register. It sets the APSR.GE bits according to the results of the additions.

Encoding T1 ARMv6T2, ARMv7

UADD8<c> <Rd>, <Rn>, <Rm>

15	14	13	12	11	10	9	8	7	6	5	4	3	2	1	0	15	14	13	12	11	10	9	8	7	6	5	4	3	2	1	0
1	1	1	1	1	0	1	0	1	0	0	0	Rn			1	1	1	1	Rd			0	1	0	0	Rm					

d = UInt(Rd); n = UInt(Rn); m = UInt(Rm);
 if BadReg(d) || BadReg(n) || BadReg(m) then UNPREDICTABLE;

Encoding A1 ARMv6*, ARMv7

UADD8<c> <Rd>, <Rn>, <Rm>

31	30	29	28	27	26	25	24	23	22	21	20	19	18	17	16	15	14	13	12	11	10	9	8	7	6	5	4	3	2	1	0
cond		0	1	1	0	0	1	0	1	Rn			Rd			(1)	(1)	(1)	(1)	1			0	0	1	Rm					

d = UInt(Rd); n = UInt(Rn); m = UInt(Rm);
 if d == 15 || n == 15 || m == 15 then UNPREDICTABLE;

Assembler syntax

UADD8<c><q> {<Rd>}, <Rn>, <Rm>

where:

<c><q> See *Standard assembler syntax fields* on page A8-7.

<Rd> The destination register.

<Rn> The first operand register.

<Rm> The second operand register.

Operation

```
if ConditionPassed() then
    EncodingSpecificOperations();
    sum1 = UInt(R[n]<7:0>) + UInt(R[m]<7:0>);
    sum2 = UInt(R[n]<15:8>) + UInt(R[m]<15:8>);
    sum3 = UInt(R[n]<23:16>) + UInt(R[m]<23:16>);
    sum4 = UInt(R[n]<31:24>) + UInt(R[m]<31:24>);
    R[d]<7:0> = sum1<7:0>;
    R[d]<15:8> = sum2<7:0>;
    R[d]<23:16> = sum3<7:0>;
    R[d]<31:24> = sum4<7:0>;
    APSR.GE<0> = if sum1 >= 0x100 then '1' else '0';
    APSR.GE<1> = if sum2 >= 0x100 then '1' else '0';
    APSR.GE<2> = if sum3 >= 0x100 then '1' else '0';
    APSR.GE<3> = if sum4 >= 0x100 then '1' else '0';
```

Exceptions

None.

A8.6.235 UASX

Unsigned Add and Subtract with Exchange exchanges the two halfwords of the second operand, performs one unsigned 16-bit integer addition and one unsigned 16-bit subtraction, and writes the results to the destination register. It sets the APSR.GE bits according to the results.

Encoding T1 ARMv6T2, ARMv7

UASX<c> <Rd>, <Rn>, <Rm>

15	14	13	12	11	10	9	8	7	6	5	4	3	2	1	0	15	14	13	12	11	10	9	8	7	6	5	4	3	2	1	0
1	1	1	1	1	0	1	0	1	0	1	0	Rn			1	1	1	1	Rd			0	1	0	0	Rm					

d = UInt(Rd); n = UInt(Rn); m = UInt(Rm);
 if BadReg(d) || BadReg(n) || BadReg(m) then UNPREDICTABLE;

Encoding A1 ARMv6*, ARMv7

UASX<c> <Rd>, <Rn>, <Rm>

31	30	29	28	27	26	25	24	23	22	21	20	19	18	17	16	15	14	13	12	11	10	9	8	7	6	5	4	3	2	1	0
cond		0	1	1	0	0	1	0	1	Rn			Rd			(1)	(1)	(1)	(1)	0	0	1	1	Rm							

d = UInt(Rd); n = UInt(Rn); m = UInt(Rm);
 if d == 15 || n == 15 || m == 15 then UNPREDICTABLE;

Assembler syntax

UASX<c><q> {<Rd>}, <Rn>, <Rm>

where:

<c><q> See *Standard assembler syntax fields* on page A8-7.

<Rd> The destination register.

<Rn> The first operand register.

<Rm> The second operand register.

The pre-UAL syntax UADDSUBX<c> is equivalent to UASX<c>.

Operation

```
if ConditionPassed() then
    EncodingSpecificOperations();
    diff = UInt(R[n]<15:0>) - UInt(R[m]<31:16>);
    sum  = UInt(R[n]<31:16>) + UInt(R[m]<15:0>);
    R[d]<15:0> = diff<15:0>;
    R[d]<31:16> = sum<15:0>;
    APSR.GE<1:0> = if diff >= 0 then '11' else '00';
    APSR.GE<3:2> = if sum >= 0x10000 then '11' else '00';
```

Exceptions

None.

A8.6.236 UBFX

Unsigned Bit Field Extract extracts any number of adjacent bits at any position from a register, zero-extends them to 32 bits, and writes the result to the destination register.

Encoding T1 ARMv6T2, ARMv7

UBFX<c> <Rd>, <Rn>, #<lsb>, #<width>

15	14	13	12	11	10	9	8	7	6	5	4	3	2	1	0	15	14	13	12	11	10	9	8	7	6	5	4	3	2	1	0
1	1	1	1	0	(0)	1	1	1	1	0	0	Rn	0	imm3	Rd	imm2	(0)	widthm1													

```
d = UInt(Rd); n = UInt(Rn);
lsbit = UInt(imm3:imm2); widthminus1 = UInt(widthm1);
if BadReg(d) || BadReg(n) then UNPREDICTABLE;
```

Encoding A1 ARMv6T2, ARMv7

UBFX<c> <Rd>, <Rn>, #<lsb>, #<width>

31	30	29	28	27	26	25	24	23	22	21	20	19	18	17	16	15	14	13	12	11	10	9	8	7	6	5	4	3	2	1	0
cond		0	1	1	1	1	1	1	widthm1	Rd	lsb	1	0	1	Rn																

```
d = UInt(Rd); n = UInt(Rn);
lsbit = UInt(1sb); widthminus1 = UInt(widthm1);
if d == 15 || n == 15 then UNPREDICTABLE;
```

Assembler syntax

UBFX<c><q> <Rd>, <Rn>, #<lsb>, #<width>

where:

<c><q>	See <i>Standard assembler syntax fields</i> on page A8-7.
<Rd>	The destination register.
<Rn>	The first operand register.
<lsb>	is the bit number of the least significant bit in the bitfield, in the range 0-31. This determines the required value of <code>lsbit</code> .
<width>	is the width of the bitfield, in the range 1 to 32-<lsb>. The required value of <code>widthminus1</code> is <code><width>-1</code> .

Operation

```

if ConditionPassed() then
    EncodingSpecificOperations();
    msbit = lsbit + widthminus1;
    if msbit <= 31 then
        R[d] = ZeroExtend(R[n]<msbit:lsbit>, 32);
    else
        UNPREDICTABLE;

```

Exceptions

None.

A8.6.237 UDIV

Unsigned Divide divides a 32-bit unsigned integer register value by a 32-bit unsigned integer register value, and writes the result to the destination register. The condition code flags are not affected.

Encoding T1 ARMv7-R

UDIV<c> <Rd>, <Rn>, <Rm>

15	14	13	12	11	10	9	8	7	6	5	4	3	2	1	0	15	14	13	12	11	10	9	8	7	6	5	4	3	2	1	0
1	1	1	1	1	0	1	1	1	0	1	1	Rn			(1) (1) (1) (1)				Rd			1 1 1 1				Rm					

d = UInt(Rd); n = UInt(Rn); m = UInt(Rm);
 if BadReg(d) || BadReg(n) || BadReg(m) then UNPREDICTABLE;

Assembler syntax

UDIV<c><q> {<Rd>}, <Rn>, <Rm>

where:

<c><q> See *Standard assembler syntax fields* on page A8-7.

<Rd> The destination register.

<Rn> The register that contains the dividend.

<Rm> The register that contains the divisor.

Operation

```

if ConditionPassed() then
    EncodingSpecificOperations();
    if UInt(R[m]) == 0 then
        if IntegerZeroDivideTrappingEnabled() then
            GenerateIntegerZeroDivide();
        else
            result = 0;
    else
        result = RoundTowardsZero(UInt(R[n]) / UInt(R[m]));
    R[d] = result<31:0>;

```

Exceptions

Undefined Instruction.

A8.6.238 UHADD16

Unsigned Halving Add 16 performs two unsigned 16-bit integer additions, halves the results, and writes the results to the destination register.

Encoding T1 ARMv6T2, ARMv7

UHADD16<c> <Rd>, <Rn>, <Rm>

15	14	13	12	11	10	9	8	7	6	5	4	3	2	1	0	15	14	13	12	11	10	9	8	7	6	5	4	3	2	1	0
1	1	1	1	1	0	1	0	1	0	0	1	Rn				1	1	1	1	Rd				0	1	1	0	Rm			

d = UInt(Rd); n = UInt(Rn); m = UInt(Rm);
 if BadReg(d) || BadReg(n) || BadReg(m) then UNPREDICTABLE;

Encoding A1 ARMv6*, ARMv7

UHADD16<c> <Rd>, <Rn>, <Rm>

31	30	29	28	27	26	25	24	23	22	21	20	19	18	17	16	15	14	13	12	11	10	9	8	7	6	5	4	3	2	1	0
cond		0	1	1	0	0	1	1	1	Rn				Rd				(1)	(1)	(1)	(1)	0	0	0	1	Rm					

d = UInt(Rd); n = UInt(Rn); m = UInt(Rm);
 if d == 15 || n == 15 || m == 15 then UNPREDICTABLE;

Assembler syntax

UHADD16<c><q> {<Rd>}, <Rn>, <Rm>

where:

<c><q> See *Standard assembler syntax fields* on page A8-7.

<Rd> The destination register.

<Rn> The first operand register.

<Rm> The second operand register.

Operation

```
if ConditionPassed() then
    EncodingSpecificOperations();
    sum1 = UInt(R[n]<15:0>) + UInt(R[m]<15:0>);
    sum2 = UInt(R[n]<31:16>) + UInt(R[m]<31:16>);
    R[d]<15:0> = sum1<16:1>;
    R[d]<31:16> = sum2<16:1>;
```

Exceptions

None.

A8.6.239 UHADD8

Unsigned Halving Add 8 performs four unsigned 8-bit integer additions, halves the results, and writes the results to the destination register.

Encoding T1 ARMv6T2, ARMv7

UHADD8<c> <Rd>, <Rn>, <Rm>

15	14	13	12	11	10	9	8	7	6	5	4	3	2	1	0	15	14	13	12	11	10	9	8	7	6	5	4	3	2	1	0
1	1	1	1	1	0	1	0	1	0	0	0	Rn			1	1	1	1	Rd			0	1	1	0	Rm					

d = UInt(Rd); n = UInt(Rn); m = UInt(Rm);
 if BadReg(d) || BadReg(n) || BadReg(m) then UNPREDICTABLE;

Encoding A1 ARMv6*, ARMv7

UHADD8<c> <Rd>, <Rn>, <Rm>

31	30	29	28	27	26	25	24	23	22	21	20	19	18	17	16	15	14	13	12	11	10	9	8	7	6	5	4	3	2	1	0
cond		0	1	1	0	0	1	1	1	Rn			Rd			(1)	(1)	(1)	(1)	1	0	0	1	Rm							

d = UInt(Rd); n = UInt(Rn); m = UInt(Rm);
 if d == 15 || n == 15 || m == 15 then UNPREDICTABLE;

Assembler syntax

UHADD8<c><q> {<Rd>}, <Rn>, <Rm>

where:

<c><q> See *Standard assembler syntax fields* on page A8-7.

<Rd> The destination register.

<Rn> The first operand register.

<Rm> The second operand register.

Operation

```
if ConditionPassed() then
    EncodingSpecificOperations();
    sum1 = UInt(R[n]<7:0>) + UInt(R[m]<7:0>);
    sum2 = UInt(R[n]<15:8>) + UInt(R[m]<15:8>);
    sum3 = UInt(R[n]<23:16>) + UInt(R[m]<23:16>);
    sum4 = UInt(R[n]<31:24>) + UInt(R[m]<31:24>);
    R[d]<7:0>  = sum1<8:1>;
    R[d]<15:8> = sum2<8:1>;
    R[d]<23:16> = sum3<8:1>;
    R[d]<31:24> = sum4<8:1>;
```

Exceptions

None.

A8.6.240 UHASX

Unsigned Halving Add and Subtract with Exchange exchanges the two halfwords of the second operand, performs one unsigned 16-bit integer addition and one unsigned 16-bit subtraction, halves the results, and writes the results to the destination register.

Encoding T1 ARMv6T2, ARMv7

UHASX<c> <Rd>, <Rn>, <Rm>

15	14	13	12	11	10	9	8	7	6	5	4	3	2	1	0	15	14	13	12	11	10	9	8	7	6	5	4	3	2	1	0
1	1	1	1	1	0	1	0	1	0	1	0	Rn				1	1	1	1	Rd				0	1	1	0	Rm			

d = UInt(Rd); n = UInt(Rn); m = UInt(Rm);
 if BadReg(d) || BadReg(n) || BadReg(m) then UNPREDICTABLE;

Encoding A1 ARMv6*, ARMv7

UHASX<c> <Rd>, <Rn>, <Rm>

31	30	29	28	27	26	25	24	23	22	21	20	19	18	17	16	15	14	13	12	11	10	9	8	7	6	5	4	3	2	1	0
cond		0	1	1	0	0	1	1	1	Rn				Rd				(1)	(1)	(1)	(1)	0	0	1	1	Rm					

d = UInt(Rd); n = UInt(Rn); m = UInt(Rm);
 if d == 15 || n == 15 || m == 15 then UNPREDICTABLE;

Assembler syntax

UHASX<c><q> {<Rd>}, <Rn>, <Rm>

where:

<c><q> See *Standard assembler syntax fields* on page A8-7.

<Rd> The destination register.

<Rn> The first operand register.

<Rm> The second operand register.

The pre-UAL syntax UHADDSUBX<c> is equivalent to UHASX<c>.

Operation

```
if ConditionPassed() then
    EncodingSpecificOperations();
    diff = UInt(R[n]<15:0>) - UInt(R[m]<31:16>);
    sum = UInt(R[n]<31:16>) + UInt(R[m]<15:0>);
    R[d]<15:0> = diff<16:1>;
    R[d]<31:16> = sum<16:1>;
```

Exceptions

None.

A8.6.241 UHSAX

Unsigned Halving Subtract and Add with Exchange exchanges the two halfwords of the second operand, performs one unsigned 16-bit integer subtraction and one unsigned 16-bit addition, halves the results, and writes the results to the destination register.

Encoding T1 ARMv6T2, ARMv7

UHSAX<c> <Rd>, <Rn>, <Rm>

15	14	13	12	11	10	9	8	7	6	5	4	3	2	1	0	15	14	13	12	11	10	9	8	7	6	5	4	3	2	1	0
1	1	1	1	1	0	1	0	1	1	1	0	Rn			1	1	1	1	Rd			0	1	1	0	Rm					

d = UInt(Rd); n = UInt(Rn); m = UInt(Rm);
 if BadReg(d) || BadReg(n) || BadReg(m) then UNPREDICTABLE;

Encoding A1 ARMv6*, ARMv7

UHSAX<c> <Rd>, <Rn>, <Rm>

31	30	29	28	27	26	25	24	23	22	21	20	19	18	17	16	15	14	13	12	11	10	9	8	7	6	5	4	3	2	1	0
cond		0	1	1	0	0	1	1	1	Rn			Rd			(1)	(1)	(1)	(1)	0	1	0	1	Rm							

d = UInt(Rd); n = UInt(Rn); m = UInt(Rm);
 if d == 15 || n == 15 || m == 15 then UNPREDICTABLE;

Assembler syntax

UHSAX<c><q> {<Rd>,<Rn>, <Rm>

where:

<c><q> See *Standard assembler syntax fields* on page A8-7.

<Rd> The destination register.

<Rn> The first operand register.

<Rm> The second operand register.

The pre-UAL syntax UHSUBADDX<c> is equivalent to UHSAX<c>.

Operation

```
if ConditionPassed() then
    EncodingSpecificOperations();
    sum = UInt(R[n]<15:0>) + UInt(R[m]<31:16>);
    diff = UInt(R[n]<31:16>) - UInt(R[m]<15:0>);
    R[d]<15:0> = sum<16:1>;
    R[d]<31:16> = diff<16:1>;
```

Exceptions

None.

A8.6.242 UHSUB16

Unsigned Halving Subtract 16 performs two unsigned 16-bit integer subtractions, halves the results, and writes the results to the destination register.

Encoding T1 ARMv6T2, ARMv7

UHSUB16<c> <Rd>, <Rn>, <Rm>

15	14	13	12	11	10	9	8	7	6	5	4	3	2	1	0	15	14	13	12	11	10	9	8	7	6	5	4	3	2	1	0
1	1	1	1	1	0	1	0	1	1	0	1	Rn			1	1	1	1	Rd			0	1	1	0	Rm					

d = UInt(Rd); n = UInt(Rn); m = UInt(Rm);
 if BadReg(d) || BadReg(n) || BadReg(m) then UNPREDICTABLE;

Encoding A1 ARMv6*, ARMv7

UHSUB16<c> <Rd>, <Rn>, <Rm>

31	30	29	28	27	26	25	24	23	22	21	20	19	18	17	16	15	14	13	12	11	10	9	8	7	6	5	4	3	2	1	0
cond		0	1	1	0	0	1	1	1	Rn			Rd			(1)	(1)	(1)	(1)	0	1	1	1	Rm							

d = UInt(Rd); n = UInt(Rn); m = UInt(Rm);
 if d == 15 || n == 15 || m == 15 then UNPREDICTABLE;

Assembler syntax

UHSUB16<c><q> {<Rd>}, <Rn>, <Rm>

where:

<c><q> See *Standard assembler syntax fields* on page A8-7.

<Rd> The destination register.

<Rn> The first operand register.

<Rm> The second operand register.

Operation

```
if ConditionPassed() then
    EncodingSpecificOperations();
    diff1 = UInt(R[n]<15:0>) - UInt(R[m]<15:0>);
    diff2 = UInt(R[n]<31:16>) - UInt(R[m]<31:16>);
    R[d]<15:0> = diff1<16:1>;
    R[d]<31:16> = diff2<16:1>;
```

Exceptions

None.

A8.6.243 UHSUB8

Unsigned Halving Subtract 8 performs four unsigned 8-bit integer subtractions, halves the results, and writes the results to the destination register.

Encoding T1 ARMv6T2, ARMv7

UHSUB8<c> <Rd>, <Rn>, <Rm>

15	14	13	12	11	10	9	8	7	6	5	4	3	2	1	0	15	14	13	12	11	10	9	8	7	6	5	4	3	2	1	0
1	1	1	1	1	0	1	0	1	1	0	0	Rn			1	1	1	1	Rd			0	1	1	0	Rm					

d = UInt(Rd); n = UInt(Rn); m = UInt(Rm);
 if BadReg(d) || BadReg(n) || BadReg(m) then UNPREDICTABLE;

Encoding A1 ARMv6*, ARMv7

UHSUB8<c> <Rd>, <Rn>, <Rm>

31	30	29	28	27	26	25	24	23	22	21	20	19	18	17	16	15	14	13	12	11	10	9	8	7	6	5	4	3	2	1	0
cond		0	1	1	0	0	1	1	1	Rn			Rd			(1)	(1)	(1)	(1)	1	1	1	1	Rm							

d = UInt(Rd); n = UInt(Rn); m = UInt(Rm);
 if d == 15 || n == 15 || m == 15 then UNPREDICTABLE;

Assembler syntax

UHSUB8<c><q> {<Rd>}, <Rn>, <Rm>

where:

<c><q> See *Standard assembler syntax fields* on page A8-7.

<Rd> The destination register.

<Rn> The first operand register.

<Rm> The second operand register.

Operation

```
if ConditionPassed() then
    EncodingSpecificOperations();
    diff1 = UInt(R[n]<7:0>) - UInt(R[m]<7:0>);
    diff2 = UInt(R[n]<15:8>) - UInt(R[m]<15:8>);
    diff3 = UInt(R[n]<23:16>) - UInt(R[m]<23:16>);
    diff4 = UInt(R[n]<31:24>) - UInt(R[m]<31:24>);
    R[d]<7:0> = diff1<8:1>;
    R[d]<15:8> = diff2<8:1>;
    R[d]<23:16> = diff3<8:1>;
    R[d]<31:24> = diff4<8:1>;
```

Exceptions

None.

A8.6.244 UMAAL

Unsigned Multiply Accumulate Accumulate Long multiplies two unsigned 32-bit values to produce a 64-bit value, adds two unsigned 32-bit values, and writes the 64-bit result to two registers.

Encoding T1 ARMv6T2, ARMv7

UMAAL<c> <RdLo>, <RdHi>, <Rn>, <Rm>

	15	14	13	12	11	10	9	8	7	6	5	4	3	2	1	0		15	14	13	12	11	10	9	8	7	6	5	4	3	2	1	0
	1	1	1	1	1	0	1	1	1	1	1	0	Rn			RdLo			RdHi			0			1	1	0	Rm					

```
dLo = UInt(RdLo); dHi = UInt(RdHi); n = UInt(Rn); m = UInt(Rm);
if BadReg(dLo) || BadReg(dHi) || BadReg(n) || BadReg(m) then UNPREDICTABLE;
if dHi == dLo then UNPREDICTABLE;
```

Encoding A1 ARMv6*, ARMv7

UMAAL<c> <RdLo>, <RdHi>, <Rn>, <Rm>

	31	30	29	28	27	26	25	24	23	22	21	20	19	18	17	16	15	14	13	12	11	10	9	8	7	6	5	4	3	2	1	0
cond	0	0	0	0	0	0	1	0	0	RdHi			RdLo			Rm			1			0	0	1	Rn							

```
dLo = UInt(RdLo); dHi = UInt(RdHi); n = UInt(Rn); m = UInt(Rm);
if dLo == 15 || dHi == 15 || n == 15 || m == 15 then UNPREDICTABLE;
if dHi == dLo then UNPREDICTABLE;
```

Assembler syntax

UMAAL<c><q> <RdLo>, <RdHi>, <Rn>, <Rm>

where:

- <c><q> See *Standard assembler syntax fields* on page A8-7.
- <RdLo> Supplies one of the 32 bit values to be added, and is the destination register for the lower 32 bits of the result.
- <RdHi> Supplies the other of the 32 bit values to be added, and is the destination register for the upper 32 bits of the result.
- <Rn> The register that contains the first multiply operand.
- <Rm> The register that contains the second multiply operand.

Operation

```
if ConditionPassed() then
    EncodingSpecificOperations();
    result = UInt(R[n]) * UInt(R[m]) + UInt(R[dHi]) + UInt(R[dLo]);
    R[dHi] = result<63:32>;
    R[dLo] = result<31:0>;
```

Exceptions

None.

A8.6.245 UMLAL

Unsigned Multiply Accumulate Long multiplies two unsigned 32-bit values to produce a 64-bit value, and accumulates this with a 64-bit value.

In ARM code, the condition flags can optionally be updated based on the result. Use of this option adversely affects performance on many processor implementations.

Encoding T1 ARMv6T2, ARMv7

UMLAL<C> <RdLo>, <RdHi>, <Rn>, <Rm>

15	14	13	12	11	10	9	8	7	6	5	4	3	2	1	0	15	14	13	12	11	10	9	8	7	6	5	4	3	2	1	0
1	1	1	1	1	0	1	1	1	1	1	0	Rn				RdLo				RdHi				0 0 0 0				Rm			

```
dLo = UInt(RdLo); dHi = UInt(RdHi); n = UInt(Rn); m = UInt(Rm); setflags = FALSE;
if BadReg(dLo) || BadReg(dHi) || BadReg(n) || BadReg(m) then UNPREDICTABLE;
if dHi == dLo then UNPREDICTABLE;
```

Encoding A1 ARMv4*, ARMv5T*, ARMv6*, ARMv7

UMLAL{S}<C> <RdLo>, <RdHi>, <Rn>, <Rm>

31	30	29	28	27	26	25	24	23	22	21	20	19	18	17	16	15	14	13	12	11	10	9	8	7	6	5	4	3	2	1	0
cond				0 0 0 0 1 0 1				S	RdHi				RdLo				Rm				1 0 0 1				Rn						

```
dLo = UInt(RdLo); dHi = UInt(RdHi); n = UInt(Rn); m = UInt(Rm); setflags = (S == '1');
if dLo == 15 || dHi == 15 || n == 15 || m == 15 then UNPREDICTABLE;
if dHi == dLo then UNPREDICTABLE;
if ArchVersion() < 6 && (dHi == n || dLo == n) then UNPREDICTABLE;
```

Assembler syntax

UMLAL{S}<c><q> <RdLo>, <RdHi>, <Rn>, <Rm>

where:

- S If S is present, the instruction updates the flags. Otherwise, the flags are not updated.
S can be specified only for the ARM instruction set.
- <c><q> See *Standard assembler syntax fields* on page A8-7.
- <RdLo> Supplies the lower 32 bits of the accumulate value, and is the destination register for the lower 32 bits of the result.
- <RdHi> Supplies the upper 32 bits of the accumulate value, and is the destination register for the upper 32 bits of the result.
- <Rn> The first operand register.
- <Rm> The second operand register.

The pre-UAL syntax UMLAL<c>S is equivalent to UMLALS<c>.

Operation

```
if ConditionPassed() then
    EncodingSpecificOperations();
    result = UInt(R[n]) * UInt(R[m]) + UInt(R[dHi]:R[dLo]);
    R[dHi] = result<63:32>;
    R[dLo] = result<31:0>;
    if setflags then
        APSR.N = result<63>;
        APSR.Z = IsZeroBit(result<63:0>);
        if ArchVersion() == 4 then
            APSR.C = bit UNKNOWN;
            APSR.V = bit UNKNOWN;
        // else APSR.C, APSR.V unchanged
```

Exceptions

None.

A8.6.246 UMULL

Unsigned Multiply Long multiplies two 32-bit unsigned values to produce a 64-bit result.

In ARM code, the condition flags can optionally be updated based on the result. Use of this option adversely affects performance on many processor implementations.

Encoding T1 ARMv6T2, ARMv7

UMULL<c> <RdLo>, <RdHi>, <Rn>, <Rm>

15	14	13	12	11	10	9	8	7	6	5	4	3	2	1	0	15	14	13	12	11	10	9	8	7	6	5	4	3	2	1	0
1	1	1	1	1	0	1	1	1	0	1	0	Rn				RdLo				RdHi				0 0 0 0				Rm			

```
dLo = UInt(RdLo); dHi = UInt(RdHi); n = UInt(Rn); m = UInt(Rm); setflags = FALSE;
if BadReg(dLo) || BadReg(dHi) || BadReg(n) || BadReg(m) then UNPREDICTABLE;
if dHi == dLo then UNPREDICTABLE;
```

Encoding A1 ARMv4*, ARMv5T*, ARMv6*, ARMv7

UMULL{S}<c> <RdLo>, <RdHi>, <Rn>, <Rm>

31	30	29	28	27	26	25	24	23	22	21	20	19	18	17	16	15	14	13	12	11	10	9	8	7	6	5	4	3	2	1	0
cond				0 0 0 0 1 0 0				S	RdHi				RdLo				Rm				1 0 0 1				Rn						

```
dLo = UInt(RdLo); dHi = UInt(RdHi); n = UInt(Rn); m = UInt(Rm); setflags = (S == '1');
if dLo == 15 || dHi == 15 || n == 15 || m == 15 then UNPREDICTABLE;
if dHi == dLo then UNPREDICTABLE;
if ArchVersion() < 6 && (dHi == n || dLo == m) then UNPREDICTABLE;
```

Assembler syntax

UMULL{S}<c><q> <RdLo>, <RdHi>, <Rn>, <Rm>

where:

S If S is present, the instruction updates the flags. Otherwise, the flags are not updated.

S can be specified only for the ARM instruction set.

<c><q> See *Standard assembler syntax fields* on page A8-7.

<RdLo> Stores the lower 32 bits of the result.

<RdHi> Stores the upper 32 bits of the result.

<Rn> The first operand register.

<Rm> The second operand register.

The pre-UAL syntax UMULL<c>S is equivalent to UMULLS<c>.

Operation

```
if ConditionPassed() then
    EncodingSpecificOperations();
    result = UInt(R[n]) * UInt(R[m]);
    R[dHi] = result<63:32>;
    R[dLo] = result<31:0>;
    if setflags then
        APSR.N = result<63>;
        APSR.Z = IsZeroBit(result<63:0>);
        if ArchVersion() == 4 then
            APSR.C = bit UNKNOWN;
            APSR.V = bit UNKNOWN;
        // else APSR.C, APSR.V unchanged
```

Exceptions

None.

A8.6.247 UQADD16

Unsigned Saturating Add 16 performs two unsigned 16-bit integer additions, saturates the results to the 16-bit unsigned integer range $0 \leq x \leq 2^{16} - 1$, and writes the results to the destination register.

Encoding T1 ARMv6T2, ARMv7

UQADD16<c> <Rd>, <Rn>, <Rm>

15	14	13	12	11	10	9	8	7	6	5	4	3	2	1	0	15	14	13	12	11	10	9	8	7	6	5	4	3	2	1	0
1	1	1	1	1	0	1	0	1	0	0	1	Rn				1	1	1	1	Rd				0	1	0	1	Rm			

d = UInt(Rd); n = UInt(Rn); m = UInt(Rm);
 if BadReg(d) || BadReg(n) || BadReg(m) then UNPREDICTABLE;

Encoding A1 ARMv6*, ARMv7

UQADD16<c> <Rd>, <Rn>, <Rm>

31	30	29	28	27	26	25	24	23	22	21	20	19	18	17	16	15	14	13	12	11	10	9	8	7	6	5	4	3	2	1	0
cond		0	1	1	0	0	1	1	0	Rn				Rd				(1)	(1)	(1)	(1)	0	0	0	1	Rm					

d = UInt(Rd); n = UInt(Rn); m = UInt(Rm);
 if d == 15 || n == 15 || m == 15 then UNPREDICTABLE;

Assembler syntax

UQADD16<c><q> {<Rd>}, <Rn>, <Rm>

where:

<c><q> See *Standard assembler syntax fields* on page A8-7.

<Rd> The destination register.

<Rn> The first operand register.

<Rm> The second operand register.

Operation

```
if ConditionPassed() then
    EncodingSpecificOperations();
    sum1 = UInt(R[n]<15:0>) + UInt(R[m]<15:0>);
    sum2 = UInt(R[n]<31:16>) + UInt(R[m]<31:16>);
    R[d]<15:0> = UnsignedSat(sum1, 16);
    R[d]<31:16> = UnsignedSat(sum2, 16);
```

Exceptions

None.

A8.6.248 UQADD8

Unsigned Saturating Add 8 performs four unsigned 8-bit integer additions, saturates the results to the 8-bit unsigned integer range $0 \leq x \leq 2^8 - 1$, and writes the results to the destination register.

Encoding T1 ARMv6T2, ARMv7

UQADD8<c> <Rd>, <Rn>, <Rm>

15	14	13	12	11	10	9	8	7	6	5	4	3	2	1	0	15	14	13	12	11	10	9	8	7	6	5	4	3	2	1	0
1	1	1	1	1	0	1	0	1	0	0	0	Rn			1	1	1	1	Rd			0	1	0	1	Rm					

d = UInt(Rd); n = UInt(Rn); m = UInt(Rm);
 if BadReg(d) || BadReg(n) || BadReg(m) then UNPREDICTABLE;

Encoding A1 ARMv6*, ARMv7

UQADD8<c> <Rd>, <Rn>, <Rm>

31	30	29	28	27	26	25	24	23	22	21	20	19	18	17	16	15	14	13	12	11	10	9	8	7	6	5	4	3	2	1	0
cond		0	1	1	0	0	1	1	0	Rn			Rd			(1)	(1)	(1)	(1)	1	0	0	1	Rm							

d = UInt(Rd); n = UInt(Rn); m = UInt(Rm);
 if d == 15 || n == 15 || m == 15 then UNPREDICTABLE;

Assembler syntax

UQADD8<c><q> {<Rd>}, <Rn>, <Rm>

where:

<c><q> See *Standard assembler syntax fields* on page A8-7.

<Rd> The destination register.

<Rn> The first operand register.

<Rm> The second operand register.

Operation

```
if ConditionPassed() then
    EncodingSpecificOperations();
    sum1 = UInt(R[n]<7:0>) + UInt(R[m]<7:0>);
    sum2 = UInt(R[n]<15:8>) + UInt(R[m]<15:8>);
    sum3 = UInt(R[n]<23:16>) + UInt(R[m]<23:16>);
    sum4 = UInt(R[n]<31:24>) + UInt(R[m]<31:24>);
    R[d]<7:0> = UnsignedSat(sum1, 8);
    R[d]<15:8> = UnsignedSat(sum2, 8);
    R[d]<23:16> = UnsignedSat(sum3, 8);
    R[d]<31:24> = UnsignedSat(sum4, 8);
```

Exceptions

None.

A8.6.249 UQASX

Unsigned Saturating Add and Subtract with Exchange exchanges the two halfwords of the second operand, performs one unsigned 16-bit integer addition and one unsigned 16-bit subtraction, saturates the results to the 16-bit unsigned integer range $0 \leq x \leq 2^{16} - 1$, and writes the results to the destination register.

Encoding T1 ARMv6T2, ARMv7

UQASX<c> <Rd>, <Rn>, <Rm>

15	14	13	12	11	10	9	8	7	6	5	4	3	2	1	0	15	14	13	12	11	10	9	8	7	6	5	4	3	2	1	0
1	1	1	1	1	0	1	0	1	0	1	0	Rn				1	1	1	1	Rd				0	1	0	1	Rm			

d = UInt(Rd); n = UInt(Rn); m = UInt(Rm);
 if BadReg(d) || BadReg(n) || BadReg(m) then UNPREDICTABLE;

Encoding A1 ARMv6*, ARMv7

UQASX<c> <Rd>, <Rn>, <Rm>

31	30	29	28	27	26	25	24	23	22	21	20	19	18	17	16	15	14	13	12	11	10	9	8	7	6	5	4	3	2	1	0
cond		0	1	1	0	0	1	1	0	Rn				Rd				(1)	(1)	(1)	(1)	0	0	1	1	Rm					

d = UInt(Rd); n = UInt(Rn); m = UInt(Rm);
 if d == 15 || n == 15 || m == 15 then UNPREDICTABLE;

Assembler syntax

UQASX<c><q> {<Rd>,<Rn>, <Rm>

where:

<c><q> See *Standard assembler syntax fields* on page A8-7.

<Rd> The destination register.

<Rn> The first operand register.

<Rm> The second operand register.

The pre-UAL syntax UQADDSUBX<c> is equivalent to UQASX<c>.

Operation

```
if ConditionPassed() then
    EncodingSpecificOperations();
    diff = UInt(R[n]<15:0>) - UInt(R[m]<31:16>);
    sum  = UInt(R[n]<31:16>) + UInt(R[m]<15:0>);
    R[d]<15:0> = UnsignedSat(diff, 16);
    R[d]<31:16> = UnsignedSat(sum, 16);
```

Exceptions

None.

A8.6.250 UQSAX

Unsigned Saturating Subtract and Add with Exchange exchanges the two halfwords of the second operand, performs one unsigned 16-bit integer subtraction and one unsigned 16-bit addition, saturates the results to the 16-bit unsigned integer range $0 \leq x \leq 2^{16} - 1$, and writes the results to the destination register.

Encoding T1 ARMv6T2, ARMv7

UQSAX<c> <Rd>, <Rn>, <Rm>

15	14	13	12	11	10	9	8	7	6	5	4	3	2	1	0	15	14	13	12	11	10	9	8	7	6	5	4	3	2	1	0
1	1	1	1	1	0	1	0	1	1	1	0	Rn				1	1	1	1	Rd				0	1	0	1	Rm			

d = UInt(Rd); n = UInt(Rn); m = UInt(Rm);
 if BadReg(d) || BadReg(n) || BadReg(m) then UNPREDICTABLE;

Encoding A1 ARMv6*, ARMv7

UQSAX<c> <Rd>, <Rn>, <Rm>

31	30	29	28	27	26	25	24	23	22	21	20	19	18	17	16	15	14	13	12	11	10	9	8	7	6	5	4	3	2	1	0
cond		0	1	1	0	0	1	1	0	Rn				Rd				(1)	(1)	(1)	(1)	0	1	0	1	Rm					

d = UInt(Rd); n = UInt(Rn); m = UInt(Rm);
 if d == 15 || n == 15 || m == 15 then UNPREDICTABLE;

Assembler syntax

UQSAX<c><q> {<Rd>}, <Rn>, <Rm>

where:

<c><q> See *Standard assembler syntax fields* on page A8-7.

<Rd> The destination register.

<Rn> The first operand register.

<Rm> The second operand register.

The pre-UAL syntax UQSUBADDX<c> is equivalent to UQSAX<c>.

Operation

```
if ConditionPassed() then
    EncodingSpecificOperations();
    sum = UInt(R[n]<15:0>) + UInt(R[m]<31:16>);
    diff = UInt(R[n]<31:16>) - UInt(R[m]<15:0>);
    R[d]<15:0> = UnsignedSat(sum, 16);
    R[d]<31:16> = UnsignedSat(diff, 16);
```

Exceptions

None.

A8.6.251 UQSUB16

Unsigned Saturating Subtract 16 performs two unsigned 16-bit integer subtractions, saturates the results to the 16-bit unsigned integer range $0 \leq x \leq 2^{16} - 1$, and writes the results to the destination register.

Encoding T1 ARMv6T2, ARMv7

UQSUB16<c> <Rd>, <Rn>, <Rm>

15	14	13	12	11	10	9	8	7	6	5	4	3	2	1	0	15	14	13	12	11	10	9	8	7	6	5	4	3	2	1	0
1	1	1	1	1	0	1	0	1	1	0	1	Rn			1	1	1	1	Rd			0	1	0	1	Rm					

d = UInt(Rd); n = UInt(Rn); m = UInt(Rm);
 if BadReg(d) || BadReg(n) || BadReg(m) then UNPREDICTABLE;

Encoding A1 ARMv6*, ARMv7

UQSUB16<c> <Rd>, <Rn>, <Rm>

31	30	29	28	27	26	25	24	23	22	21	20	19	18	17	16	15	14	13	12	11	10	9	8	7	6	5	4	3	2	1	0
cond		0	1	1	0	0	1	1	0	Rn			Rd			(1)	(1)	(1)	(1)	0	1	1	1	Rm							

d = UInt(Rd); n = UInt(Rn); m = UInt(Rm);
 if d == 15 || n == 15 || m == 15 then UNPREDICTABLE;

Assembler syntax

UQSUB16<c><q> {<Rd>}, <Rn>, <Rm>

where:

<c><q> See *Standard assembler syntax fields* on page A8-7.

<Rd> The destination register.

<Rn> The first operand register.

<Rm> The second operand register.

Operation

```
if ConditionPassed() then
    EncodingSpecificOperations();
    diff1 = UInt(R[n]<15:0>) - UInt(R[m]<15:0>);
    diff2 = UInt(R[n]<31:16>) - UInt(R[m]<31:16>);
    R[d]<15:0> = UnsignedSat(diff1, 16);
    R[d]<31:16> = UnsignedSat(diff2, 16);
```

Exceptions

None.

A8.6.252 UQSUB8

Unsigned Saturating Subtract 8 performs four unsigned 8-bit integer subtractions, saturates the results to the 8-bit unsigned integer range $0 \leq x \leq 2^8 - 1$, and writes the results to the destination register.

Encoding T1 ARMv6T2, ARMv7

UQSUB8<c> <Rd>, <Rn>, <Rm>

15	14	13	12	11	10	9	8	7	6	5	4	3	2	1	0	15	14	13	12	11	10	9	8	7	6	5	4	3	2	1	0
1	1	1	1	1	0	1	0	1	1	0	0	Rn			1	1	1	1	Rd			0	1	0	1	Rm					

d = UInt(Rd); n = UInt(Rn); m = UInt(Rm);
 if BadReg(d) || BadReg(n) || BadReg(m) then UNPREDICTABLE;

Encoding A1 ARMv6*, ARMv7

UQSUB8<c> <Rd>, <Rn>, <Rm>

31	30	29	28	27	26	25	24	23	22	21	20	19	18	17	16	15	14	13	12	11	10	9	8	7	6	5	4	3	2	1	0
cond		0	1	1	0	0	1	1	0	Rn			Rd			(1)	(1)	(1)	(1)	1	1	1	1	Rm							

d = UInt(Rd); n = UInt(Rn); m = UInt(Rm);
 if d == 15 || n == 15 || m == 15 then UNPREDICTABLE;

Assembler syntax

UQSUB8<c><q> {<Rd>}, <Rn>, <Rm>

where:

<c><q> See *Standard assembler syntax fields* on page A8-7.

<Rd> The destination register.

<Rn> The first operand register.

<Rm> The second operand register.

Operation

```
if ConditionPassed() then
    EncodingSpecificOperations();
    diff1 = UInt(R[n]<7:0>) - UInt(R[m]<7:0>);
    diff2 = UInt(R[n]<15:8>) - UInt(R[m]<15:8>);
    diff3 = UInt(R[n]<23:16>) - UInt(R[m]<23:16>);
    diff4 = UInt(R[n]<31:24>) - UInt(R[m]<31:24>);
    R[d]<7:0> = UnsignedSat(diff1, 8);
    R[d]<15:8> = UnsignedSat(diff2, 8);
    R[d]<23:16> = UnsignedSat(diff3, 8);
    R[d]<31:24> = UnsignedSat(diff4, 8);
```

Exceptions

None.

A8.6.253 USAD8

Unsigned Sum of Absolute Differences performs four unsigned 8-bit subtractions, and adds the absolute values of the differences together.

Encoding T1 ARMv6T2, ARMv7

USAD8<c> <Rd>, <Rn>, <Rm>

15	14	13	12	11	10	9	8	7	6	5	4	3	2	1	0	15	14	13	12	11	10	9	8	7	6	5	4	3	2	1	0
1	1	1	1	1	0	1	1	1	0	1	1	1	Rn			1	1	1	1				Rd			0	0	0	0	Rm	

d = UInt(Rd); n = UInt(Rn); m = UInt(Rm);
 if BadReg(d) || BadReg(n) || BadReg(m) then UNPREDICTABLE;

Encoding A1 ARMv6*, ARMv7

USAD8<c> <Rd>, <Rn>, <Rm>

31	30	29	28	27	26	25	24	23	22	21	20	19	18	17	16	15	14	13	12	11	10	9	8	7	6	5	4	3	2	1	0
cond		0	1	1	1	1	0	0	0			Rd		1	1	1	1			Rm			0	0	0	1			Rn		

d = UInt(Rd); n = UInt(Rn); m = UInt(Rm);
 if d == 15 || n == 15 || m == 15 then UNPREDICTABLE;

Assembler syntax

USAD8<c><q> {<Rd>}, <Rn>, <Rm>

where:

<c><q> See *Standard assembler syntax fields* on page A8-7.

<Rd> The destination register.

<Rn> The first operand register.

<Rm> The second operand register.

Operation

```
if ConditionPassed() then
    EncodingSpecificOperations();
    absdiff1 = Abs(UInt(R[n]<7:0>) - UInt(R[m]<7:0>));
    absdiff2 = Abs(UInt(R[n]<15:8>) - UInt(R[m]<15:8>));
    absdiff3 = Abs(UInt(R[n]<23:16>) - UInt(R[m]<23:16>));
    absdiff4 = Abs(UInt(R[n]<31:24>) - UInt(R[m]<31:24>));
    result = absdiff1 + absdiff2 + absdiff3 + absdiff4;
    R[d] = result<31:0>;
```

Exceptions

None.

A8.6.254 USADA8

Unsigned Sum of Absolute Differences and Accumulate performs four unsigned 8-bit subtractions, and adds the absolute values of the differences to a 32-bit accumulate operand.

Encoding T1 ARMv6T2, ARMv7

USADA8<c> <Rd>, <Rn>, <Rm>, <Ra>

15	14	13	12	11	10	9	8	7	6	5	4	3	2	1	0	15	14	13	12	11	10	9	8	7	6	5	4	3	2	1	0
1	1	1	1	1	0	1	1	0	1	1	1	Rn				Ra				Rd				0	0	0	0	Rm			

if Ra == '1111' then SEE USAD8;
d = UInt(Rd); n = UInt(Rn); m = UInt(Rm); a == UInt(Ra);
if BadReg(d) || BadReg(n) || BadReg(m) || BadReg(a) then UNPREDICTABLE;

Encoding A1 ARMv6*, ARMv7

USADA8<c> <Rd>, <Rn>, <Rm>, <Ra>

31	30	29	28	27	26	25	24	23	22	21	20	19	18	17	16	15	14	13	12	11	10	9	8	7	6	5	4	3	2	1	0
cond		0	1	1	1	1	0	0	0	Rd				Ra				Rm				0	0	0	1	Rn					

if Ra == '1111' then SEE USAD8;
d = UInt(Rd); n = UInt(Rn); m = UInt(Rm); a == UInt(Ra);
if d == 15 || n == 15 || m == 15 || a == 15 then UNPREDICTABLE;

Assembler syntax

USADA8<c><q> <Rd>, <Rn>, <Rm>, <Ra>

where:

<c><q> See *Standard assembler syntax fields* on page A8-7.

<Rd> The destination register.

<Rn> The first operand register.

<Rm> The second operand register.

<Ra> The register that contains the accumulation value.

Operation

```
if ConditionPassed() then
    EncodingSpecificOperations();
    absdiff1 = Abs(UInt(R[n]<7:0> - UInt(R[m]<7:0>));
    absdiff2 = Abs(UInt(R[n]<15:8> - UInt(R[m]<15:8>));
    absdiff3 = Abs(UInt(R[n]<23:16> - UInt(R[m]<23:16>));
    absdiff4 = Abs(UInt(R[n]<31:24> - UInt(R[m]<31:24>));
    result = UInt(R[a]) + absdiff1 + absdiff2 + absdiff3 + absdiff4;
    R[d] = result<31:0>;
```

Exceptions

None.

A8.6.255 USAT

Unsigned Saturate saturates an optionally-shifted signed value to a selected unsigned range.

The Q flag is set if the operation saturates.

Encoding T1 ARMv6T2, ARMv7

USAT<c> <Rd>, #<imm5>, <Rn>{, <shift>}

15	14	13	12	11	10	9	8	7	6	5	4	3	2	1	0	15	14	13	12	11	10	9	8	7	6	5	4	3	2	1	0
1	1	1	1	0	(0)	1	1	1	0	sh	0	Rn				0	imm3			Rd				imm2		(0)	sat_imm				

```

if sh == '1' && (imm3:imm2) == '00000' then SEE USAT16;
d = UInt(Rd); n = UInt(Rn); saturate_to = UInt(sat_imm);
(shift_t, shift_n) = DecodeImmShift(sh:'0', imm3:imm2);
if BadReg(d) || BadReg(n) then UNPREDICTABLE;
    
```

Encoding A1 ARMv6*, ARMv7

USAT<c> <Rd>, #<imm5>, <Rn>{, <shift>}

31	30	29	28	27	26	25	24	23	22	21	20	19	18	17	16	15	14	13	12	11	10	9	8	7	6	5	4	3	2	1	0
cond		0	1	1	0	1	1	1	sat_imm				Rd				imm5			sh	0	1	Rn								

```

d = UInt(Rd); n = UInt(Rn); saturate_to = UInt(sat_imm);
(shift_t, shift_n) = DecodeImmShift(sh:'0', imm5);
if d == 15 || n == 15 then UNPREDICTABLE;
    
```

Assembler syntax

USAT<c><q> <Rd>, #<imm>, <Rn> {,<shift>}

where:

<c><q>	See <i>Standard assembler syntax fields</i> on page A8-7.
<Rd>	The destination register.
<imm>	The bit position for saturation, in the range 0 to 31.
<Rn>	The register that contains the value to be saturated.
<shift>	The optional shift, encoded in the sh bit and five bits in imm3:imm2 for encoding T1 and imm5 for encoding A1. It must be one of: <ul style="list-style-type: none"> omitted No shift. Encoded as sh = 0, five bits = 0b00000 LSL #<n> Left shift by <n> bits, with <n> in the range 1-31. Encoded as sh = 0, five bits = <n>. ASR #<n> Arithmetic right shift by <n> bits, with <n> in the range 1-31. Encoded as sh = 1, five bits = <n>. ASR #32 Arithmetic right shift by 32 bits, permitted only for encoding A1. Encoded as sh = 1, imm5 = 0b00000.

Note

An assembler can permit ASR #0 or LSL #0 to mean the same thing as omitting the shift, but this is not standard UAL and must not be used for disassembly.

Operation

```
if ConditionPassed() then
    EncodingSpecificOperations();
    operand = Shift(R[n], shift_t, shift_n, APSR.C); // APSR.C ignored
    (result, sat) = UnsignedSatQ(SInt(operand), saturate_to);
    R[d] = ZeroExtend(result, 32);
    if sat then
        APSR.Q = '1';
```

Exceptions

None.

A8.6.256 USAT16

Unsigned Saturate 16 saturates two signed 16-bit values to a selected unsigned range.

The Q flag is set if the operation saturates.

Encoding T1 ARMv6T2, ARMv7

USAT16<c> <Rd>, #<imm4>, <Rn>

15	14	13	12	11	10	9	8	7	6	5	4	3	2	1	0	15	14	13	12	11	10	9	8	7	6	5	4	3	2	1	0
1	1	1	1	0	(0)	1	1	1	0	1	0	Rn				0	0	0	0	Rd		0	0	(0)	(0)	sat_imm					

d = UInt(Rd); n = UInt(Rn); saturate_to = UInt(sat_imm);
 if BadReg(d) || BadReg(n) then UNPREDICTABLE;

Encoding A1 ARMv6*, ARMv7

USAT16<c> <Rd>, #<imm4>, <Rn>

31	30	29	28	27	26	25	24	23	22	21	20	19	18	17	16	15	14	13	12	11	10	9	8	7	6	5	4	3	2	1	0
cond	0	1	1	0	1	1	1	0	sat_imm			Rd		(1)	(1)	(1)	(1)	0	0	1	1										Rn

d = UInt(Rd); n = UInt(Rn); saturate_to = UInt(sat_imm);
 if d == 15 || n == 15 then UNPREDICTABLE;

Assembler syntax

USAT16<c><q> <Rd>, #<imm>, <Rn>

where:

<c><q> See *Standard assembler syntax fields* on page A8-7.

<Rd> The destination register.

<imm> The bit position for saturation, in the range 0 to 15.

<Rn> The register that contains the values to be saturated.

Operation

```

if ConditionPassed() then
    EncodingSpecificOperations();
    (result1, sat1) = UnsignedSatQ(SInt(R[n]<15:0>), saturate_to);
    (result2, sat2) = UnsignedSatQ(SInt(R[n]<31:16>), saturate_to);
    R[d]<15:0> = ZeroExtend(result1, 16);
    R[d]<31:16> = ZeroExtend(result2, 16);
    if sat1 || sat2 then
        APSR.Q = '1';

```

Exceptions

None.

A8.6.257 USAX

Unsigned Subtract and Add with Exchange exchanges the two halfwords of the second operand, performs one unsigned 16-bit integer subtraction and one unsigned 16-bit addition, and writes the results to the destination register. It sets the APSR.GE bits according to the results.

Encoding T1 ARMv6T2, ARMv7

USAX<c> <Rd>, <Rn>, <Rm>

15	14	13	12	11	10	9	8	7	6	5	4	3	2	1	0	15	14	13	12	11	10	9	8	7	6	5	4	3	2	1	0
1	1	1	1	1	0	1	0	1	1	1	0	Rn			1	1	1	1	Rd			0	1	0	0	Rm					

d = UInt(Rd); n = UInt(Rn); m = UInt(Rm);
 if BadReg(d) || BadReg(n) || BadReg(m) then UNPREDICTABLE;

Encoding A1 ARMv6*, ARMv7

USAX<c> <Rd>, <Rn>, <Rm>

31	30	29	28	27	26	25	24	23	22	21	20	19	18	17	16	15	14	13	12	11	10	9	8	7	6	5	4	3	2	1	0
cond		0	1	1	0	0	1	0	1	Rn			Rd			(1)	(1)	(1)	(1)	0	1	0	1	Rm							

d = UInt(Rd); n = UInt(Rn); m = UInt(Rm);
 if d == 15 || n == 15 || m == 15 then UNPREDICTABLE;

Assembler syntax

USAX<c><q> {<Rd>}, <Rn>, <Rm>

where:

<c><q> See *Standard assembler syntax fields* on page A8-7.

<Rd> The destination register.

<Rn> The first operand register.

<Rm> The second operand register.

The pre-UAL syntax USUBADDX<c> is equivalent to USAX<c>.

Operation

```
if ConditionPassed() then
    EncodingSpecificOperations();
    sum = UInt(R[n]<15:0>) + UInt(R[m]<31:16>);
    diff = UInt(R[n]<31:16>) - UInt(R[m]<15:0>);
    R[d]<15:0> = sum<15:0>;
    R[d]<31:16> = diff<15:0>;
    APSR.GE<1:0> = if sum >= 0x10000 then '11' else '00';
    APSR.GE<3:2> = if diff >= 0 then '11' else '00';
```

Exceptions

None.

A8.6.258 USUB16

Unsigned Subtract 16 performs two 16-bit unsigned integer subtractions, and writes the results to the destination register. It sets the APSR.GE bits according to the results of the subtractions.

Encoding T1 ARMv6T2, ARMv7

USUB16<c> <Rd>, <Rn>, <Rm>

15	14	13	12	11	10	9	8	7	6	5	4	3	2	1	0	15	14	13	12	11	10	9	8	7	6	5	4	3	2	1	0
1	1	1	1	1	0	1	0	1	1	0	1	Rn			1	1	1	1	Rd			0	1	0	0	Rm					

d = UInt(Rd); n = UInt(Rn); m = UInt(Rm);
 if BadReg(d) || BadReg(n) || BadReg(m) then UNPREDICTABLE;

Encoding A1 ARMv6*, ARMv7

USUB16<c> <Rd>, <Rn>, <Rm>

31	30	29	28	27	26	25	24	23	22	21	20	19	18	17	16	15	14	13	12	11	10	9	8	7	6	5	4	3	2	1	0
cond		0	1	1	0	0	1	0	1	Rn			Rd			(1)	(1)	(1)	(1)	0	1	1	1	Rm							

d = UInt(Rd); n = UInt(Rn); m = UInt(Rm);
 if d == 15 || n == 15 || m == 15 then UNPREDICTABLE;

Assembler syntax

USUB16<c><q> {<Rd>}, <Rn>, <Rm>

where:

<c><q> See *Standard assembler syntax fields* on page A8-7.

<Rd> The destination register.

<Rn> The first operand register.

<Rm> The second operand register.

Operation

```
if ConditionPassed() then
    EncodingSpecificOperations();
    diff1 = UInt(R[n]<15:0>) - UInt(R[m]<15:0>);
    diff2 = UInt(R[n]<31:16>) - UInt(R[m]<31:16>);
    R[d]<15:0> = diff1<15:0>;
    R[d]<31:16> = diff2<15:0>;
    APSR.GE<1:0> = if diff1 >= 0 then '11' else '00';
    APSR.GE<3:2> = if diff2 >= 0 then '11' else '00';
```

Exceptions

None.

A8.6.259 USUB8

Unsigned Subtract 8 performs four 8-bit unsigned integer subtractions, and writes the results to the destination register. It sets the APSR.GE bits according to the results of the subtractions.

Encoding T1 ARMv6T2, ARMv7

USUB8<c> <Rd>, <Rn>, <Rm>

15	14	13	12	11	10	9	8	7	6	5	4	3	2	1	0	15	14	13	12	11	10	9	8	7	6	5	4	3	2	1	0
1	1	1	1	1	0	1	0	1	1	0	0	Rn			1	1	1	1	Rd			0	1	0	0	Rm					

d = UInt(Rd); n = UInt(Rn); m = UInt(Rm);
 if BadReg(d) || BadReg(n) || BadReg(m) then UNPREDICTABLE;

Encoding A1 ARMv6*, ARMv7

USUB8<c> <Rd>, <Rn>, <Rm>

31	30	29	28	27	26	25	24	23	22	21	20	19	18	17	16	15	14	13	12	11	10	9	8	7	6	5	4	3	2	1	0
cond		0	1	1	0	0	1	0	1	Rn			Rd			(1)	(1)	(1)	(1)	1			1	1	1	1	Rm				

d = UInt(Rd); n = UInt(Rn); m = UInt(Rm);
 if d == 15 || n == 15 || m == 15 then UNPREDICTABLE;

Assembler syntax

USUB8<c><q> {<Rd>}, <Rn>, <Rm>

where:

<c><q> See *Standard assembler syntax fields* on page A8-7.

<Rd> The destination register.

<Rn> The first operand register.

<Rm> The second operand register.

Operation

```

if ConditionPassed() then
    EncodingSpecificOperations();
    diff1 = UInt(R[n]<7:0>) - UInt(R[m]<7:0>);
    diff2 = UInt(R[n]<15:8>) - UInt(R[m]<15:8>);
    diff3 = UInt(R[n]<23:16>) - UInt(R[m]<23:16>);
    diff4 = UInt(R[n]<31:24>) - UInt(R[m]<31:24>);
    R[d]<7:0> = diff1<7:0>;
    R[d]<15:8> = diff2<7:0>;
    R[d]<23:16> = diff3<7:0>;
    R[d]<31:24> = diff4<7:0>;
    APSR.GE<0> = if diff1 >= 0 then '1' else '0';
    APSR.GE<1> = if diff2 >= 0 then '1' else '0';
    APSR.GE<2> = if diff3 >= 0 then '1' else '0';
    APSR.GE<3> = if diff4 >= 0 then '1' else '0';

```

Exceptions

None.

A8.6.260 UXTAB

Unsigned Extend and Add Byte extracts an 8-bit value from a register, zero-extends it to 32 bits, adds the result to the value in another register, and writes the final result to the destination register. You can specify a rotation by 0, 8, 16, or 24 bits before extracting the 8-bit value.

Encoding T1 ARMv6T2, ARMv7

UXTAB<c> <Rd>, <Rn>, <Rm>{, <rotation>}

15	14	13	12	11	10	9	8	7	6	5	4	3	2	1	0	15	14	13	12	11	10	9	8	7	6	5	4	3	2	1	0
1	1	1	1	1	0	1	0	0	1	0	1	Rn				1	1	1	1	Rd				1	(0)	rotate	Rm				

if Rn == '1111' then SEE UXTB;
d = UInt(Rd); n = UInt(Rn); m = UInt(Rm); rotation = UInt(rotate:'000');
if BadReg(d) || n == 13 || BadReg(m) then UNPREDICTABLE;

Encoding A1 ARMv6*, ARMv7

UXTAB<c> <Rd>, <Rn>, <Rm>{, <rotation>}

31	30	29	28	27	26	25	24	23	22	21	20	19	18	17	16	15	14	13	12	11	10	9	8	7	6	5	4	3	2	1	0
cond		0	1	1	0	1	1	1	0	Rn				Rd				rotate	(0)	(0)	0	1	1	1	Rm						

if Rn == '1111' then SEE UXTB;
d = UInt(Rd); n = UInt(Rn); m = UInt(Rm); rotation = UInt(rotate:'000');
if d == 15 || m == 15 then UNPREDICTABLE;

Assembler syntax

UXTAB<c><q> {<Rd>,> <Rn>, <Rm> {, <rotation>}

where:

<c><q> See *Standard assembler syntax fields* on page A8-7.

<Rd> The destination register.

<Rn> The first operand register.

<Rm> The second operand register.

<rotation> This can be any one of:
omitted encoded as rotate = '00'
 ROR #8 encoded as rotate = '01'
 ROR #16 encoded as rotate = '10'
 ROR #24 encoded as rotate = '11'.

————— Note —————

An assembler can permit ROR #0 to mean the same thing as omitting the rotation, possibly with restrictions on the permitted encodings, but this is not standard UAL and must not be used for disassembly.

Operation

```
if ConditionPassed() then
    EncodingSpecificOperations();
    rotated = ROR(R[m], rotation);
    R[d] = R[n] + ZeroExtend(rotated<7:0>, 32);
```

Exceptions

None.

A8.6.261 UXTAB16

Unsigned Extend and Add Byte 16 extracts two 8-bit values from a register, zero-extends them to 16 bits each, adds the results to two 16-bit values from another register, and writes the final results to the destination register. You can specify a rotation by 0, 8, 16, or 24 bits before extracting the 8-bit values.

Encoding T1 ARMv6T2, ARMv7

UXTAB16<c> <Rd>, <Rn>, <Rm>{, <rotation>}

15	14	13	12	11	10	9	8	7	6	5	4	3	2	1	0	15	14	13	12	11	10	9	8	7	6	5	4	3	2	1	0
1	1	1	1	1	0	1	0	0	0	1	1	Rn				1	1	1	1	Rd				1	(0)	rotate	Rm				

if Rn == '1111' then SEE UXTB16;
d = UInt(Rd); n = UInt(Rn); m = UInt(Rm); rotation = UInt(rotate:'000');
if BadReg(d) || n == 13 || BadReg(m) then UNPREDICTABLE;

Encoding A1 ARMv6*, ARMv7

UXTAB16<c> <Rd>, <Rn>, <Rm>{, <rotation>}

31	30	29	28	27	26	25	24	23	22	21	20	19	18	17	16	15	14	13	12	11	10	9	8	7	6	5	4	3	2	1	0
cond		0	1	1	0	1	1	0	0	Rn				Rd				rotate	(0)	(0)	0	1	1	1	Rm						

if Rn == '1111' then SEE UXTB16;
d = UInt(Rd); n = UInt(Rn); m = UInt(Rm); rotation = UInt(rotate:'000');
if d == 15 || m == 15 then UNPREDICTABLE;

Assembler syntax

UXTAB16<c><q> {<Rd>}, <Rn>, <Rm> {, <rotation>}

where:

<c><q> See *Standard assembler syntax fields* on page A8-7.

<Rd> The destination register.

<Rn> The first operand register.

<Rm> The second operand register.

<rotation> This can be any one of:

omitted encoded as rotate = '00'
 ROR #8 encoded as rotate = '01'
 ROR #16 encoded as rotate = '10'
 ROR #24 encoded as rotate = '11'.

————— Note —————

An assembler can permit ROR #0 to mean the same thing as omitting the rotation, possibly with restrictions on the permitted encodings, but this is not standard UAL and must not be used for disassembly.

Operation

```
if ConditionPassed() then
    EncodingSpecificOperations();
    rotated = ROR(R[m], rotation);
    R[d]<15:0> = R[n]<15:0> + ZeroExtend(rotated<7:0>, 16);
    R[d]<31:16> = R[n]<31:16> + ZeroExtend(rotated<23:16>, 16);
```

Exceptions

None.

A8.6.262 UXTAH

Unsigned Extend and Add Halfword extracts a 16-bit value from a register, zero-extends it to 32 bits, adds the result to a value from another register, and writes the final result to the destination register. You can specify a rotation by 0, 8, 16, or 24 bits before extracting the 16-bit value.

Encoding T1 ARMv6T2, ARMv7

UXTAH<c> <Rd>, <Rn>, <Rm>{, <rotation>}

15	14	13	12	11	10	9	8	7	6	5	4	3	2	1	0	15	14	13	12	11	10	9	8	7	6	5	4	3	2	1	0
1	1	1	1	1	0	1	0	0	0	0	1	Rn				1	1	1	1	Rd				1	(0)	rotate	Rm				

if Rn == '1111' then SEE UXTH;
d = UInt(Rd); n = UInt(Rn); m = UInt(Rm); rotation = UInt(rotate:'000');
if BadReg(d) || n == 13 || BadReg(m) then UNPREDICTABLE;

Encoding A1 ARMv6*, ARMv7

UXTAH<c> <Rd>, <Rn>, <Rm>{, <rotation>}

31	30	29	28	27	26	25	24	23	22	21	20	19	18	17	16	15	14	13	12	11	10	9	8	7	6	5	4	3	2	1	0
cond		0	1	1	0	1	1	1	1	Rn				Rd				rotate	(0)	(0)	0	1	1	1	Rm						

if Rn == '1111' then SEE UXTH;
d = UInt(Rd); n = UInt(Rn); m = UInt(Rm); rotation = UInt(rotate:'000');
if d == 15 || m == 15 then UNPREDICTABLE;

Assembler syntax

UXTAH<c><q> {<Rd>,<Rn>, <Rm> {, <rotation>}

where:

<c><q> See *Standard assembler syntax fields* on page A8-7.

<Rd> The destination register.

<Rn> The first operand register.

<Rm> The second operand register.

<rotation> This can be any one of:
omitted encoded as rotate = '00'
 ROR #8 encoded as rotate = '01'
 ROR #16 encoded as rotate = '10'
 ROR #24 encoded as rotate = '11'.

————— Note —————

An assembler can permit ROR #0 to mean the same thing as omitting the rotation, possibly with restrictions on the permitted encodings, but this is not standard UAL and must not be used for disassembly.

Operation

```
if ConditionPassed() then
    EncodingSpecificOperations();
    rotated = ROR(R[m], rotation);
    R[d] = R[n] + ZeroExtend(rotated<15:0>, 32);
```

Exceptions

None.

A8.6.263 UXTB

Unsigned Extend Byte extracts an 8-bit value from a register, zero-extends it to 32 bits, and writes the result to the destination register. You can specify a rotation by 0, 8, 16, or 24 bits before extracting the 8-bit value.

Encoding T1 ARMv6*, ARMv7

UXTB<c> <Rd>, <Rm>

15	14	13	12	11	10	9	8	7	6	5	4	3	2	1	0
1	0	1	1	0	0	1	0	1	1	Rm				Rd	

d = UInt(Rd); m = UInt(Rm); rotation = 0;

Encoding T2 ARMv6T2, ARMv7

UXTB<c>.W <Rd>, <Rm>{, <rotation>}

15	14	13	12	11	10	9	8	7	6	5	4	3	2	1	0	15	14	13	12	11	10	9	8	7	6	5	4	3	2	1	0
1	1	1	1	1	0	1	0	0	1	0	1	1	1	1	1	1	1	1	1	Rd	1	(0)	rotate		Rm						

d = UInt(Rd); m = UInt(Rm); rotation = UInt(rotate:'000');
 if BadReg(d) || BadReg(m) then UNPREDICTABLE;

Encoding A1 ARMv6*, ARMv7

UXTB<c> <Rd>, <Rm>{, <rotation>}

31	30	29	28	27	26	25	24	23	22	21	20	19	18	17	16	15	14	13	12	11	10	9	8	7	6	5	4	3	2	1	0
cond		0	1	1	0	1	1	1	0	1	1	1	1	Rd	rotate	(0)	(0)	0	1	1	1	Rm									

d = UInt(Rd); m = UInt(Rm); rotation = UInt(rotate:'000');
 if d == 15 || m == 15 then UNPREDICTABLE;

Assembler syntax

UXTB<c><q> {<Rd>}, <Rm> {, <rotation>}

where:

<c><q> See *Standard assembler syntax fields* on page A8-7.

<Rd> The destination register.

<Rm> The second operand register.

<rotation> This can be any one of:

omitted any encoding, with rotate = '00' in encoding T2 or A1

ROR #8 encoding T2 or A1, rotate = '01'

ROR #16 encoding T2 or A1, rotate = '10'

ROR #24 encoding T2 or A1, rotate = '11'

Note

An assembler can permit ROR #0 to mean the same thing as omitting the rotation, possibly with restrictions on the permitted encodings, but this is not standard UAL and must not be used for disassembly.

Operation

```
if ConditionPassed() then
    EncodingSpecificOperations();
    rotated = ROR(R[m], rotation);
    R[d] = ZeroExtend(rotated<7:0>, 32);
```

Exceptions

None.

A8.6.264 UXTB16

Unsigned Extend Byte 16 extracts two 8-bit values from a register, zero-extends them to 16 bits each, and writes the results to the destination register. You can specify a rotation by 0, 8, 16, or 24 bits before extracting the 8-bit values.

Encoding T1 ARMv6T2, ARMv7

UXTB16<c> <Rd>, <Rm>{, <rotation>}

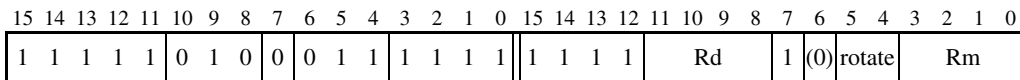

d = UInt(Rd); m = UInt(Rm); rotation = UInt(rotate:'000');
 if BadReg(d) || BadReg(m) then UNPREDICTABLE;

Encoding A1 ARMv6*, ARMv7

UXTB16<c> <Rd>, <Rm>{, <rotation>}

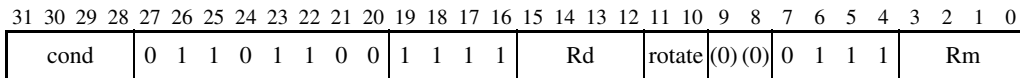

d = UInt(Rd); m = UInt(Rm); rotation = UInt(rotate:'000');
 if d == 15 || m == 15 then UNPREDICTABLE;

Assembler syntax

UXTB16<c><q> {<Rd>}, <Rm> {, <rotation>}

where:

<c><q> See *Standard assembler syntax fields* on page A8-7.

<Rd> The destination register.

<Rm> The second operand register.

<rotation> This can be any one of:

omitted encoded as rotate = '00'
 ROR #8 encoded as rotate = '01'
 ROR #16 encoded as rotate = '10'
 ROR #24 encoded as rotate = '11'.

Note

An assembler can permit ROR #0 to mean the same thing as omitting the rotation, possibly with restrictions on the permitted encodings, but this is not standard UAL and must not be used for disassembly.

Operation

```
if ConditionPassed() then
    EncodingSpecificOperations();
    rotated = ROR(R[m], rotation);
    R[d]<15:0> = ZeroExtend(rotated<7:0>, 16);
    R[d]<31:16> = ZeroExtend(rotated<23:16>, 16);
```

Exceptions

None.

A8.6.265 UXTH

Unsigned Extend Halfword extracts a 16-bit value from a register, zero-extends it to 32 bits, and writes the result to the destination register. You can specify a rotation by 0, 8, 16, or 24 bits before extracting the 16-bit value.

Encoding T1 ARMv6*, ARMv7

UXTH<c> <Rd>, <Rm>

15	14	13	12	11	10	9	8	7	6	5	4	3	2	1	0
1	0	1	1	0	0	1	0	1	0	Rm				Rd	

d = UInt(Rd); m = UInt(Rm); rotation = 0;

Encoding T2 ARMv6T2, ARMv7

UXTH<c>.W <Rd>, <Rm>{, <rotation>}

15	14	13	12	11	10	9	8	7	6	5	4	3	2	1	0	15	14	13	12	11	10	9	8	7	6	5	4	3	2	1	0
1	1	1	1	1	0	1	0	0	0	0	1	1	1	1	1	1	1	1	1	Rd	1	(0)	rotate	Rm							

d = UInt(Rd); m = UInt(Rm); rotation = UInt(rotate:'000');
 if BadReg(d) || BadReg(m) then UNPREDICTABLE;

Encoding A1 ARMv6*, ARMv7

UXTH<c> <Rd>, <Rm>{, <rotation>}

31	30	29	28	27	26	25	24	23	22	21	20	19	18	17	16	15	14	13	12	11	10	9	8	7	6	5	4	3	2	1	0
cond		0	1	1	0	1	1	1	1	1	1	1	Rd	rotate	(0)	(0)	0	1	1	1	Rm										

d = UInt(Rd); m = UInt(Rm); rotation = UInt(rotate:'000');
 if d == 15 || m == 15 then UNPREDICTABLE;

Assembler syntax

UXTH<c><q> {<Rd>}, <Rm> {, <rotation>}

where:

<c><q> See *Standard assembler syntax fields* on page A8-7.

<Rd> The destination register.

<Rm> The second operand register.

<rotation> This can be any one of:

omitted any encoding, with rotate = '00' in encoding T2 or A1

ROR #8 encoding T2 or A1, rotate = '01'

ROR #16 encoding T2 or A1, rotate = '10'

ROR #24 encoding T2 or A1, rotate = '11'

Note

An assembler can permit ROR #0 to mean the same thing as omitting the rotation, possibly with restrictions on the permitted encodings, but this is not standard UAL and must not be used for disassembly.

Operation

```
if ConditionPassed() then
    EncodingSpecificOperations();
    rotated = ROR(R[m], rotation);
    R[d] = ZeroExtend(rotated<15:0>, 32);
```

Exceptions

None.

A8.6.266 VABA, VABAL

Vector Absolute Difference and Accumulate {Long} subtracts the elements of one vector from the corresponding elements of another vector, and accumulates the absolute values of the results into the elements of the destination vector.

Operand and result elements are either all integers of the same length, or optionally the results can be double the length of the operands.

Encoding T1 / A1 Advanced SIMD

VABA<c>.<dt> <Qd>, <Qn>, <Qm>

VABA<c>.<dt> <Dd>, <Dn>, <Dm>

15	14	13	12	11	10	9	8	7	6	5	4	3	2	1	0	15	14	13	12	11	10	9	8	7	6	5	4	3	2	1	0
1	1	1	U	1	1	1	1	0	D	size	Vn					Vd	0	1	1	1	N	Q	M	1			Vm				
31	30	29	28	27	26	25	24	23	22	21	20	19	18	17	16	15	14	13	12	11	10	9	8	7	6	5	4	3	2	1	0
1	1	1	1	0	0	1	U	0	D	size	Vn					Vd	0	1	1	1	N	Q	M	1			Vm				

```

if size == '11' then UNDEFINED;
if Q == '1' && (Vd<0> == '1' || Vn<0> == '1' || Vm<0> == '1') then UNDEFINED;
unsigned = (U == '1'); long_destination = FALSE;
esize = 8 << UInt(size); elements = 64 DIV esize;
d = UInt(D:Vd); n = UInt(N:Vn); m = UInt(M:Vm); regs = if Q == '0' then 1 else 2;
    
```

Encoding T2 / A2 Advanced SIMD

VABAL<c>.<dt> <Qd>, <Dn>, <Dm>

15	14	13	12	11	10	9	8	7	6	5	4	3	2	1	0	15	14	13	12	11	10	9	8	7	6	5	4	3	2	1	0
1	1	1	U	1	1	1	1	1	D	size	Vn					Vd	0	1	0	1	N	0	M	0			Vm				
31	30	29	28	27	26	25	24	23	22	21	20	19	18	17	16	15	14	13	12	11	10	9	8	7	6	5	4	3	2	1	0
1	1	1	1	0	0	1	U	1	D	size	Vn					Vd	0	1	0	1	N	0	M	0			Vm				

```

if size == '11' then SEE "Related encodings";
if Vd<0> == '1' then UNDEFINED;
unsigned = (U == '1'); long_destination = TRUE;
esize = 8 << UInt(size); elements = 64 DIV esize;
d = UInt(D:Vd); n = UInt(N:Vn); m = UInt(M:Vm); regs = 1;
    
```

Related encodings See *Advanced SIMD data-processing instructions* on page A7-10

Assembler syntax

VABA<c><q>.<dt> <Qd>, <Qn>, <Qm>	Encoding T1 / A1, Q = 1
VABA<c><q>.<dt> <Dd>, <Dn>, <Dm>	Encoding T1 / A1, Q = 0
VABAL<c><q>.<dt> <Qd>, <Dn>, <Dm>	Encoding T2 / A2

where:

<c><q>	See <i>Standard assembler syntax fields</i> on page A8-7. An ARM VABA or VABAL instruction must be unconditional.
<dt>	The data type for the elements of the operands. It must be one of: <ul style="list-style-type: none"> S8 encoded as size = 0b00, U = 0 S16 encoded as size = 0b01, U = 0 S32 encoded as size = 0b10, U = 0 U8 encoded as size = 0b00, U = 1 U16 encoded as size = 0b01, U = 1 U32 encoded as size = 0b10, U = 1.
<Qd>, <Qn>, <Qm>	The destination vector and the operand vectors, for a quadword operation.
<Dd>, <Dn>, <Dm>	The destination vector and the operand vectors, for a doubleword operation.
<Qd>, <Dn>, <Dm>	The destination vector and the operand vectors, for a long operation.

Operation

```

if ConditionPassed() then
    EncodingSpecificOperations(); CheckAdvSIMDEnabled();
    for r = 0 to regs-1
        for e = 0 to elements-1
            op1 = Elem[D[n+r],e,esize];
            op2 = Elem[D[m+r],e,esize];
            absdiff = Abs(Int(op1,unsigned) - Int(op2,unsigned));
            if long_destination then
                Elem[Q[d>>1],e,2*esize] = Elem[Q[d>>1],e,2*esize] + absdiff;
            else
                Elem[D[d+r],e,esize] = Elem[D[d+r],e,esize] + absdiff;

```

Exceptions

Undefined Instruction.

A8.6.267 VABD, VABDL (integer)

Vector Absolute Difference {Long} (integer) subtracts the elements of one vector from the corresponding elements of another vector, and places the absolute values of the results in the elements of the destination vector.

Operand and result elements are either all integers of the same length, or optionally the results can be double the length of the operands.

Encoding T1 / A1 Advanced SIMD

VABD<c>.<dt> <Qd>, <Qn>, <Qm>

VABD<c>.<dt> <Dd>, <Dn>, <Dm>

15	14	13	12	11	10	9	8	7	6	5	4	3	2	1	0	15	14	13	12	11	10	9	8	7	6	5	4	3	2	1	0
1	1	1	U	1	1	1	1	0	D	size	Vn					Vd	0	1	1	1	N	Q	M	0			Vm				
31	30	29	28	27	26	25	24	23	22	21	20	19	18	17	16	15	14	13	12	11	10	9	8	7	6	5	4	3	2	1	0
1	1	1	1	0	0	1	U	0	D	size	Vn					Vd	0	1	1	1	N	Q	M	0			Vm				

```

if size == '11' then UNDEFINED;
if Q == '1' && (Vd<0> == '1' || Vn<0> == '1' || Vm<0> == '1') then UNDEFINED;
unsigned = (U == '1'); long_destination = FALSE;
esize = 8 << UInt(size); elements = 64 DIV esize;
d = UInt(D:Vd); n = UInt(N:Vn); m = UInt(M:Vm); regs = if Q == '0' then 1 else 2;

```

Encoding T2 / A2 Advanced SIMD

VABDL<c>.<dt> <Qd>, <Dn>, <Dm>

15	14	13	12	11	10	9	8	7	6	5	4	3	2	1	0	15	14	13	12	11	10	9	8	7	6	5	4	3	2	1	0
1	1	1	U	1	1	1	1	1	D	size	Vn					Vd	0	1	1	1	N	0	M	0			Vm				
31	30	29	28	27	26	25	24	23	22	21	20	19	18	17	16	15	14	13	12	11	10	9	8	7	6	5	4	3	2	1	0
1	1	1	1	0	0	1	U	1	D	size	Vn					Vd	0	1	1	1	N	0	M	0			Vm				

```

if size == '11' then SEE "Related encodings";
if Vd<0> == '1' then UNDEFINED;
unsigned = (U == '1'); long_destination = TRUE;
esize = 8 << UInt(size); elements = 64 DIV esize;
d = UInt(D:Vd); n = UInt(N:Vn); m = UInt(M:Vm); regs = 1;

```

Related encodings See *Advanced SIMD data-processing instructions* on page A7-10

Assembler syntax

VABD<c><q>.<dt> <Qd>, <Qn>, <Qm>	Encoding T1 / A1, Q = 1
VABD<c><q>.<dt> <Dd>, <Dn>, <Dm>	Encoding T1 / A1, Q = 0
VABDL<c><q>.<dt> <Qd>, <Dn>, <Dm>	Encoding T2 / A2

where:

<c><q>	See <i>Standard assembler syntax fields</i> on page A8-7. An ARM VABD or VABDL instruction must be unconditional.
<dt>	The data type for the elements of the operands. It must be one of: <ul style="list-style-type: none"> S8 encoded as size = 0b00, U = 0 S16 encoded as size = 0b01, U = 0 S32 encoded as size = 0b10, U = 0 U8 encoded as size = 0b00, U = 1 U16 encoded as size = 0b01, U = 1 U32 encoded as size = 0b10, U = 1.
<Qd>, <Qn>, <Qm>	The destination vector and the operand vectors, for a quadword operation.
<Dd>, <Dn>, <Dm>	The destination vector and the operand vectors, for a doubleword operation.
<Qd>, <Dn>, <Dm>	The destination vector and the operand vectors, for a long operation.

Operation

```

if ConditionPassed() then
    EncodingSpecificOperations(); CheckAdvSIMDEnabled();
    for r = 0 to regs-1
        for e = 0 to elements-1
            op1 = Elem[D[n+r],e,esize];
            op2 = Elem[D[m+r],e,esize];
            absdiff = Abs(Int(op1,unsigned) - Int(op2,unsigned));
            if long_destination then
                Elem[Q[d>>1],e,2*esize] = absdiff<2*esize-1:0>;
            else
                Elem[D[d+r],e,esize] = absdiff<esize-1:0>;

```

Exceptions

Undefined Instruction.

A8.6.268 VABD (floating-point)

Vector Absolute Difference (floating-point) subtracts the elements of one vector from the corresponding elements of another vector, and places the absolute values of the results in the elements of the destination vector.

Operand and result elements are all single-precision floating-point numbers.

Encoding T1 / A1 Advanced SIMD (UNDEFINED in integer-only variant)

VABD<c>.F32 <Qd>, <Qn>, <Qm>

VABD<c>.F32 <Dd>, <Dn>, <Dm>

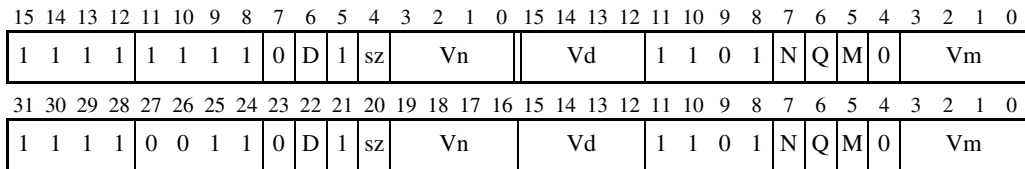

```

if Q == '1' && (Vd<0> == '1' || Vn<0> == '1' || Vm<0> == '1') then UNDEFINED;
if sz == '1' then UNDEFINED;
esize = 32; elements = 2;
d = UInt(D:Vd); n = UInt(N:Vn); m = UInt(M:Vm); regs = if Q == '0' then 1 else 2;
    
```

Assembler syntax

VABD<c><q>.F32 <Qd>, <Qn>, <Qm> Encoded as Q = 1, sz = 0
 VABD<c><q>.F32 <Dd>, <Dn>, <Dm> Encoded as Q = 0, sz = 0

where:

<c><q> See *Standard assembler syntax fields* on page A8-7. An ARM VABD instruction must be unconditional.

<Qd>, <Qn>, <Qm> The destination vector and the operand vectors, for a quadword operation.

<Dd>, <Dn>, <Dm> The destination vector and the operand vectors, for a doubleword operation.

Operation

```
if ConditionPassed() then
    EncodingSpecificOperations(); CheckAdvSIMDEnabled();
    for r = 0 to regs-1
        for e = 0 to elements-1
            op1 = Elem[D[n+r],e,esize]; op2 = Elem[D[m+r],e,esize];
            Elem[D[d+r],e,esize] = FPAbs(FPSub(op1,op2,FALSE));
```

Exceptions

Undefined Instruction.

Floating-point exceptions: Input Denormal, Invalid Operation, Overflow, Underflow, and Inexact.

A8.6.269 VABS

Vector Absolute takes the absolute value of each element in a vector, and places the results in a second vector. The floating-point version only clears the sign bit.

Encoding T1 / A1 Advanced SIMD (F = 1 UNDEFINED in integer-only variants)

VABS<c>.<dt> <Qd>, <Qm>

VABS<c>.<dt> <Dd>, <Dm>

15	14	13	12	11	10	9	8	7	6	5	4	3	2	1	0	15	14	13	12	11	10	9	8	7	6	5	4	3	2	1	0
1	1	1	1	1	1	1	1	1	D	1	1	size	0	1	Vd	0	F	1	1	0	Q	M	0	Vm							
31	30	29	28	27	26	25	24	23	22	21	20	19	18	17	16	15	14	13	12	11	10	9	8	7	6	5	4	3	2	1	0
1	1	1	1	0	0	1	1	1	D	1	1	size	0	1	Vd	0	F	1	1	0	Q	M	0	Vm							

```

if size == '11' || (F == '1' && size != '10') then UNDEFINED;
if Q == '1' && (Vd<0> == '1' || Vm<0> == '1') then UNDEFINED;
advsimd = TRUE; floating_point = (F == '1');
esize = 8 << UInt(size); elements = 64 DIV esize;
d = UInt(D:Vd); m = UInt(M:Vm); regs = if Q == '0' then 1 else 2;
    
```

Encoding T2 / A2 VFPv2, VFPv3 (sz = 1 UNDEFINED in single-precision only variants)

VABS<c>.F64 <Dd>, <Dm>

VABS<c>.F32 <Sd>, <Sm>

15	14	13	12	11	10	9	8	7	6	5	4	3	2	1	0	15	14	13	12	11	10	9	8	7	6	5	4	3	2	1	0
1	1	1	0	1	1	1	0	1	D	1	1	0	0	0	0	Vd	1	0	1	sz	1	1	M	0	Vm						
31	30	29	28	27	26	25	24	23	22	21	20	19	18	17	16	15	14	13	12	11	10	9	8	7	6	5	4	3	2	1	0
cond	1	1	1	0	1	D	1	1	0	0	0	0	Vd	1	0	1	sz	1	1	M	0	Vm									

```

if FPSCR.LEN != '000' || FPSCR.STRIDE != '00' then SEE "VFP vectors";
advsimd = FALSE; dp_operation = (sz == '1');
d = if dp_operation then UInt(D:Vd) else UInt(Vd:D);
m = if dp_operation then UInt(M:Vm) else UInt(Vm:M);
    
```

VFP vectors Encoding T2 / A2 can operate on VFP vectors under control of the FPSCR.LEN and FPSCR.STRIDE bits. For details see Appendix F *VFP Vector Operation Support*.

Assembler syntax

VABS<c><q>.<dt> <Qd>, <Qm> <dt> != F64
 VABS<c><q>.<dt> <Dd>, <Dm>
 VABS<c><q>.<F32> <Sd>, <Sm> VFP only. Encoding T2/A2, sz = 0

where:

<c><q> See *Standard assembler syntax fields* on page A8-7. An ARM Advanced SIMD VABS instruction must be unconditional.

<dt> The data type for the elements of the vectors. It must be one of:
 S8 encoding T1 / A1, size = 0b00, F = 0
 S16 encoding T1 / A1, size = 0b01, F = 0
 S32 encoding T1 / A1, size = 0b10, F = 0
 F32 encoding T1 / A1, size = 0b10, F = 1
 F64 encoding T2 / A2, sz = 1.

<Qd>, <Qm> The destination vector and the operand vector, for a quadword operation.

<Dd>, <Dm> The destination vector and the operand vector, for a doubleword operation.

<Sd>, <Sm> The destination vector and the operand vector, for a singleword operation.

Operation

```

if ConditionPassed() then
    EncodingSpecificOperations(); CheckAdvSIMDorVFPEEnabled(TRUE, advsimd);
    if advsimd then // Advanced SIMD instruction
        for r = 0 to regs-1
            for e = 0 to elements-1
                if floating_point then
                    Elem[D[d+r],e,esize] = FPAbs(Elem[D[m+r],e,esize]);
                else
                    result = Abs(SInt(Elem[D[m+r],e,esize]));
                    Elem[D[d+r],e,esize] = result<size-1:0>;
    else // VFP instruction
        if dp_operation then
            D[d] = FPAbs(D[m]);
        else
            S[d] = FPAbs(S[m]);
  
```

Exceptions

Undefined Instruction.

A8.6.270 VACGE, VACGT, VACLE, VACL

VACGE (Vector Absolute Compare Greater Than or Equal) and VACGT (Vector Absolute Compare Greater Than) take the absolute value of each element in a vector, and compare it with the absolute value of the corresponding element of a second vector. If the condition is true, the corresponding element in the destination vector is set to all ones. Otherwise, it is set to all zeros.

VACLE (Vector Absolute Compare Less Than or Equal) is a pseudo-instruction, equivalent to a VACGE instruction with the operands reversed. Disassembly produces the VACGE instruction.

VACL (Vector Absolute Compare Less Than) is a pseudo-instruction, equivalent to a VACGT instruction with the operands reversed. Disassembly produces the VACGT instruction.

The operands and result can be quadword or doubleword vectors. They must all be the same size.

The operand vector elements must be 32-bit floating-point numbers.

The result vector elements are 32-bit bitfields.

Encoding T1 / A1 Advanced SIMD (UNDEFINED in integer-only variant)

V<op><c>.F32 <Qd>, <Qn>, <Qm>

V<op><c>.F32 <Dd>, <Dn>, <Dm>

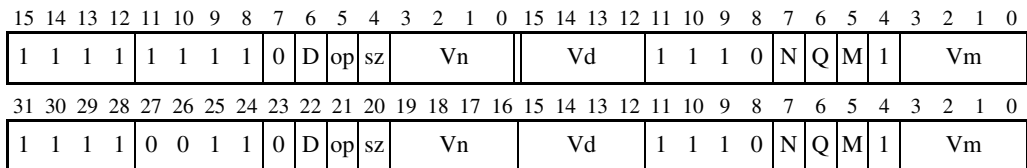

```

if Q == '1' && (Vd<0> == '1' || Vn<0> == '1' || Vm<0> == '1') then UNDEFINED;
if sz == '1' then UNDEFINED;
or_equal = (op == '0'); esize = 32; elements = 2;
d = UInt(D:Vd); n = UInt(N:Vn); m = UInt(M:Vm); regs = if Q == '0' then 1 else 2;
    
```

Assembler syntax

V<op><c><q>.F32 {<Qd>}, <Qn>, <Qm> Encoded as Q = 1
 V<op><c><q>.F32 {<Dd>}, <Dn>, <Dm> Encoded as Q = 0

where:

<op> The operation. <op> must be one of:
 ACGE Absolute Compare Greater than or Equal, encoded as op = 0
 ACGT Absolute Compare Greater Than, encoded as op = 1.

<c><q> See *Standard assembler syntax fields* on page A8-7. An ARM VACGE, VACGT, VACLE, or VACLT instruction must be unconditional.

<Qd>, <Qn>, <Qm> The destination vector and the operand vectors, for a quadword operation.

<Dd>, <Dn>, <Dm> The destination vector and the operand vectors, for a doubleword operation.

Operation

```

if ConditionPassed() then
  EncodingSpecificOperations(); CheckAdvSIMDEnabled();
  for r = 0 to regs-1
    for e = 0 to elements-1
      op1 = FPAbs(Elem[D[n+r],e,esize]); op2 = FPAbs(Elem[D[m+r],e,esize]);
      if or_equal then
        test_passed = FPCompareGE(op1, op2, FALSE);
      else
        test_passed = FPCompareGT(op1, op2, FALSE);
      Elem[D[d+r],e,esize] = if test_passed then Ones(esize) else Zeros(esize);
  
```

Exceptions

Undefined Instruction.

Floating-point exceptions: Input Denormal and Invalid Operation.

A8.6.271 VADD (integer)

Vector Add adds corresponding elements in two vectors, and places the results in the destination vector.

Encoding T1 / A1 Advanced SIMD

VADD<c>.<dt> <Qd>, <Qn>, <Qm>

VADD<c>.<dt> <Dd>, <Dn>, <Dm>

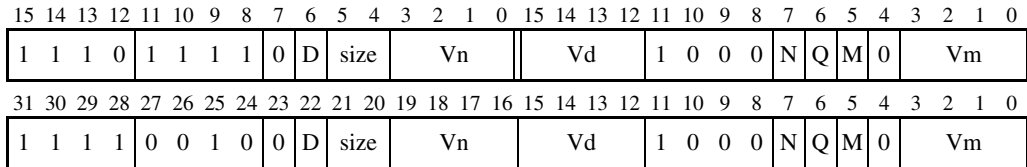

```

if Q == '1' && (Vd<0> == '1' || Vn<0> == '1' || Vm<0> == '1') then UNDEFINED;
esize = 8 << UInt(size); elements = 64 DIV esize;
d = UInt(D:Vd); n = UInt(N:Vn); m = UInt(M:Vm); regs = if Q == '0' then 1 else 2;
    
```

Assembler syntax

VADD<c><q>.<dt> {<Qd>}, <Qn>, <Qm>

VADD<c><q>.<dt> {<Dd>}, <Dn>, <Dm>

where:

<c><q> See *Standard assembler syntax fields* on page A8-7. An ARM Advanced SIMD VADD instruction must be unconditional.

<dt> The data type for the elements of the vectors. It must be one of:

I8 size = 0b00

I16 size = 0b01

I32 size = 0b10

I64 size = 0b11.

<Qd>, <Qn>, <Qm> The destination vector and the operand vectors, for a quadword operation.

<Dd>, <Dn>, <Dm> The destination vector and the operand vectors, for a doubleword operation.

Operation

```
if ConditionPassed() then
    EncodingSpecificOperations(); CheckAdvSIMDEnabled();
    for r = 0 to regs-1
        for e = 0 to elements-1
            Elem[D[d+r],e,esize] = Elem[D[n+r],e,esize] + Elem[D[m+r],e,esize];
```

Exceptions

Undefined Instruction.

A8.6.272 VADD (floating-point)

Vector Add adds corresponding elements in two vectors, and places the results in the destination vector.

Encoding T1 / A1 Advanced SIMD (UNDEFINED in integer-only variant)

VADD<c>.F32 <Qd>, <Qn>, <Qm>

VADD<c>.F32 <Dd>, <Dn>, <Dm>

15	14	13	12	11	10	9	8	7	6	5	4	3	2	1	0	15	14	13	12	11	10	9	8	7	6	5	4	3	2	1	0
1	1	1	0	1	1	1	1	0	D	0	sz	Vn			Vd			1	1	0	1	N	Q	M	0	Vm					
31	30	29	28	27	26	25	24	23	22	21	20	19	18	17	16	15	14	13	12	11	10	9	8	7	6	5	4	3	2	1	0
1	1	1	1	1	0	0	1	0	0	D	0	sz	Vn			Vd			1	1	0	1	N	Q	M	0	Vm				

```

if Q == '1' && (Vd<0> == '1' || Vn<0> == '1' || Vm<0> == '1') then UNDEFINED;
if sz == '1' then UNDEFINED;
advsimd = TRUE; esize = 32; elements = 2;
d = UInt(D:Vd); n = UInt(N:Vn); m = UInt(M:Vm); regs = if Q == '0' then 1 else 2;

```

Encoding T2 / A2 VFPv2, VFPv3 (sz = 1 UNDEFINED in single-precision only variants)

VADD<c>.F64 <Dd>, <Dn>, <Dm>

VADD<c>.F32 <Sd>, <Sn>, <Sm>

15	14	13	12	11	10	9	8	7	6	5	4	3	2	1	0	15	14	13	12	11	10	9	8	7	6	5	4	3	2	1	0
1	1	1	0	1	1	1	0	0	D	1	1	Vn			Vd			1	0	1	sz	N	0	M	0	Vm					
31	30	29	28	27	26	25	24	23	22	21	20	19	18	17	16	15	14	13	12	11	10	9	8	7	6	5	4	3	2	1	0
cond			1	1	1	0	0	D	1	1	Vn			Vd			1	0	1	sz	N	0	M	0	Vm						

```

if FPSCR.LEN != '000' || FPSCR.STRIDE != '00' then SEE "VFP vectors";
advsimd = FALSE; dp_operation = (sz == '1');
d = if dp_operation then UInt(D:Vd) else UInt(Vd:D);
n = if dp_operation then UInt(N:Vn) else UInt(Vn:N);
m = if dp_operation then UInt(M:Vm) else UInt(Vm:M);

```

VFP vectors Encoding T2 / A2 can operate on VFP vectors under control of the FPSCR.LEN and FPSCR.STRIDE bits. For details see Appendix F *VFP Vector Operation Support*.

Assembler syntax

VADD<c><q>.F32 {<Qd>}, <Qn>, <Qm>	Encoding T1 / A1, Q = 1, sz = 0
VADD<c><q>.F32 {<Dd>}, <Dn>, <Dm>	Encoding T1 / A1, Q = 0, sz = 0
VADD<c><q>.F64 {<Dd>}, <Dn>, <Dm>	Encoding T2 / A2, sz = 1
VADD<c><q>.F32 {<Sd>}, <Sn>, <Sm>	Encoding T2 / A2, sz = 0

where:

<c><q>	See <i>Standard assembler syntax fields</i> on page A8-7. An ARM Advanced SIMD VADD instruction must be unconditional.
<Qd>, <Qn>, <Qm>	The destination vector and the operand vectors, for a quadword operation.
<Dd>, <Dn>, <Dm>	The destination vector and the operand vectors, for a doubleword operation.
<Sd>, <Sn>, <Sm>	The destination vector and the operand vectors, for a singleword operation.

Operation

```

if ConditionPassed() then
    EncodingSpecificOperations(); CheckAdvSIMDorVFPEnabled(TRUE, advsimd);
    if advsimd then // Advanced SIMD instruction
        for r = 0 to regs-1
            for e = 0 to elements-1
                Elem[D[d+r],e,esize] = FPAdd(Elem[D[n+r],e,esize], Elem[D[m+r],e,esize], FALSE);
    else // VFP instruction
        if dp_operation then
            D[d] = FPAdd(D[n], D[m], TRUE);
        else
            S[d] = FPAdd(S[n], S[m], TRUE);

```

Exceptions

Undefined Instruction.

Floating-point exceptions: Input Denormal, Invalid Operation, Overflow, Underflow, and Inexact.

A8.6.273 VADDHN

Vector Add and Narrow, returning High Half adds corresponding elements in two quadword vectors, and places the most significant half of each result in a doubleword vector. The results are truncated. (For rounded results, see *VRADDHN* on page A8-726).

The operand elements can be 16-bit, 32-bit, or 64-bit integers. There is no distinction between signed and unsigned integers.

Encoding T1 / A1 Advanced SIMD

VADDHN<c>.<dt> <Dd>, <Qn>, <Qm>

15	14	13	12	11	10	9	8	7	6	5	4	3	2	1	0	15	14	13	12	11	10	9	8	7	6	5	4	3	2	1	0
1	1	1	0	1	1	1	1	1	D	size	Vn		Vd		0	1	0	0	N	0	M	0	Vm								
31	30	29	28	27	26	25	24	23	22	21	20	19	18	17	16	15	14	13	12	11	10	9	8	7	6	5	4	3	2	1	0
1	1	1	1	0	0	1	0	1	D	size	Vn		Vd		0	1	0	0	N	0	M	0	Vm								

```

if size == '11' then SEE "Related encodings";
if Vn<0> == '1' || Vm<0> == '1' then UNDEFINED;
esize = 8 << UInt(size); elements = 64 DIV esize;
d = UInt(D:Vd); n = UInt(N:Vn); m = UInt(M:Vm);
    
```

Related encodings See *Advanced SIMD data-processing instructions* on page A7-10

Assembler syntax

VADDHN<c><q>.<dt> <Dd>, <Qn>, <Qm>

where:

<c><q> See *Standard assembler syntax fields* on page A8-7. An ARM VADDHN instruction must be unconditional.

<dt> The data type for the elements of the operands. It must be one of:
 I16 size = 0b00
 I32 size = 0b01
 I64 size = 0b10.

<Dd>, <Qn>, <Qm> The destination vector, the first operand vector, and the second operand vector.

Operation

```
if ConditionPassed() then
    EncodingSpecificOperations(); CheckAdvSIMDEnabled();
    for e = 0 to elements-1
        result = Elem[Q[n>>1],e,2*esize] + Elem[Q[m>>1],e,2*esize];
        Elem[D[d],e,esize] = result<2*esize-1:esize>;
```

Exceptions

Undefined Instruction.

A8.6.274 VADDL, VADDW

VADDL (Vector Add Long) adds corresponding elements in two doubleword vectors, and places the results in a quadword vector. Before adding, it sign-extends or zero-extends the elements of both operands.

VADDW (Vector Add Wide) adds corresponding elements in one quadword and one doubleword vector, and places the results in a quadword vector. Before adding, it sign-extends or zero-extends the elements of the doubleword operand.

Encoding T1 / A1 Advanced SIMD

VADDL<c>.<dt> <Qd>, <Dn>, <Dm>

VADDW<c>.<dt> <Qd>, <Qn>, <Dm>

15	14	13	12	11	10	9	8	7	6	5	4	3	2	1	0	15	14	13	12	11	10	9	8	7	6	5	4	3	2	1	0
1	1	1	U	1	1	1	1	1	D	size	Vn				Vd				0	0	0	op	N	0	M	0	Vm				
31	30	29	28	27	26	25	24	23	22	21	20	19	18	17	16	15	14	13	12	11	10	9	8	7	6	5	4	3	2	1	0
1	1	1	1	0	0	1	U	1	D	size	Vn				Vd				0	0	0	op	N	0	M	0	Vm				

```

if size == '11' then SEE "Related encodings";
if Vd<0> == '1' || (op == '1' && Vn<0> == '1') then UNDEFINED;
esize = 8 << UInt(size); elements = 64 DIV esize; is_vaddw == (op == '1');
d = UInt(D:Vd); n = UInt(N:Vn); m = UInt(M:Vm);
    
```

Related encodings See *Advanced SIMD data-processing instructions* on page A7-10

Assembler syntax

VADDL<c><q>.<dt> <Qd>, <Dn>, <Dm> Encoded as op = 0
 VADDW<c><q>.<dt> {<Qd>,<Qn>}, <Qn>, <Dm> Encoded as op = 1

where:

<c><q> See *Standard assembler syntax fields* on page A8-7. An ARM VADDL or VADDW instruction must be unconditional.

<dt> The data type for the elements of the second operand vector. It must be one of:

S8	encoded as size = 0b00, U = 0
S16	encoded as size = 0b01, U = 0
S32	encoded as size = 0b10, U = 0
U8	encoded as size = 0b00, U = 1
U16	encoded as size = 0b01, U = 1
U32	encoded as size = 0b10, U = 1.

<Qd> The destination register. If this register is omitted in a VADDW instruction, it is the same register as <Qn>.

<Qn>, <Dm> The first and second operand registers for a VADDW instruction.

<Dn>, <Dm> The first and second operand registers for a VADDL instruction.

Operation

```
if ConditionPassed() then
    EncodingSpecificOperations(); CheckAdvSIMDEnabled();
    for e = 0 to elements-1
        if is_vaddw then
            op1 = Int(Elem[Q[n>>1],e,2*esize], unsigned);
        else
            op1 = Int(Elem[D[n],e,esize], unsigned);
        result = op1 + Int(Elem[D[m],e,esize],unsigned);
        Elem[Q[d>>1],e,2*esize] = result<2*esize-1:0>;
```

Exceptions

Undefined Instruction.

A8.6.275 VAND (immediate)

This is a pseudo-instruction, equivalent to a VBIC (immediate) instruction with the immediate value bitwise inverted. For details see *VBIC (immediate)* on page A8-546.

A8.6.276 VAND (register)

This instruction performs a bitwise AND operation between two registers, and places the result in the destination register.

Encoding T1 / A1 Advanced SIMD

VAND<c> <Qd>, <Qn>, <Qm>

VAND<c> <Dd>, <Dn>, <Dm>

15	14	13	12	11	10	9	8	7	6	5	4	3	2	1	0	15	14	13	12	11	10	9	8	7	6	5	4	3	2	1	0
1	1	1	0	1	1	1	1	0	D	0	0	Vn				Vd				0	0	0	1	N	Q	M	1	Vm			
31	30	29	28	27	26	25	24	23	22	21	20	19	18	17	16	15	14	13	12	11	10	9	8	7	6	5	4	3	2	1	0
1	1	1	1	0	0	1	0	0	D	0	0	Vn				Vd				0	0	0	1	N	Q	M	1	Vm			

```
if Q == '1' && (Vd<0> == '1' || Vn<0> == '1' || Vm<0> == '1') then UNDEFINED;
d = UInt(D:Vd); n = UInt(N:Vn); m = UInt(M:Vm); regs = if Q == '0' then 1 else 2;
```

Assembler syntax

VAND<c><q>{.<dt>} {<Qd>,> <Qn>, <Qm> Encoded as Q = 1

VAND<c><q>{.<dt>} {<Dd>,> <Dn>, <Dm> Encoded as Q = 0

where:

<c><q> See *Standard assembler syntax fields* on page A8-7. An ARM VAND instruction must be unconditional.

<dt> An optional data type. It is ignored by assemblers, and does not affect the encoding.

<Qd>, <Qn>, <Qm> The destination vector and the operand vectors, for a quadword operation.

<Dd>, <Dn>, <Dm> The destination vector and the operand vectors, for a doubleword operation.

Operation

```
if ConditionPassed() then
    EncodingSpecificOperations(); CheckAdvSIMDEnabled();
    for r = 0 to regs-1
        D[d+r] = D[n+r] AND D[m+r];
```

Exceptions

Undefined Instruction.

A8.6.277 VBIC (immediate)

Vector Bitwise Bit Clear (immediate) performs a bitwise AND between a register value and the complement of an immediate value, and returns the result into the destination vector. For the range of constants available, see *One register and a modified immediate value* on page A7-21.

Encoding T1 / A1 Advanced SIMD

VBIC<c>.<dt> <Qd>, #<imm>

VBIC<c>.<dt> <Dd>, #<imm>

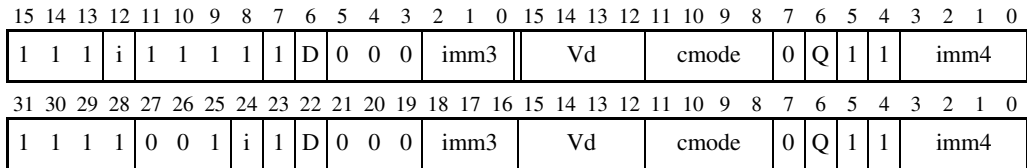

```

if cmode<0> == '0' || cmode<3:2> == '11' then SEE "Related encodings";
if Q == '1' && Vd<0> == '1' then UNDEFINED;
imm64 = AdvSIMDExpandImm('1', cmode, i:imm3:imm4);
d = UInt(D:Vd); regs = if Q == '0' then 1 else 2;
    
```

Related encodings See *One register and a modified immediate value* on page A7-21

Assembler syntax

VBIC<c><q>.<dt> {<Qd>}, <Qd>, #<imm>	Encoded as Q = 1
VBIC<c><q>.<dt> {<Dd>}, <Dd>, #<imm>>	Encoded as Q = 0

where:

<c><q>	See <i>Standard assembler syntax fields</i> on page A8-7. An ARM VBIC instruction must be unconditional.
<dt>	The data type used for <imm>. It can be either I16 or I32. I8, I64, and F32 are also permitted, but the resulting syntax is a pseudo-instruction.
<Qd>	The destination vector for a quadword operation.
<Dd>	The destination vector for a doubleword operation.
<imm>	A constant of the type specified by <dt>. This constant is replicated enough times to fill the destination register. For example, VBIC.I32 D0,#10 ANDs the complement of 0x0000000A0000000A with D0, and puts the result into D0.

For details of the range of constants available and the encoding of <dt> and <imm>, see *One register and a modified immediate value* on page A7-21.

Operation

```
if ConditionPassed() then
    EncodingSpecificOperations(); CheckAdvSIMDEnabled();
    for r = 0 to regs-1
        D[d+r] = D[d+r] AND NOT(imm64);
```

Exceptions

Undefined Instruction.

Pseudo-instructions

VAND can be used with a range of constants that are the bitwise inverse of the available constants for VBIC. This is assembled as the equivalent VBIC instruction. Disassembly produces the VBIC form.

One register and a modified immediate value on page A7-21 describes pseudo-instructions with a combination of <dt> and <imm> that is not supported by hardware, but that generates the same destination register value as a different combination that is supported by hardware.

A8.6.278 VBIC (register)

Vector Bitwise Bit Clear (register) performs a bitwise AND between a register value and the complement of a register value, and places the result in the destination register.

Encoding T1 / A1 Advanced SIMD

VBIC<c> <Qd>, <Qn>, <Qm>

VBIC<c> <Dd>, <Dn>, <Dm>

15	14	13	12	11	10	9	8	7	6	5	4	3	2	1	0	15	14	13	12	11	10	9	8	7	6	5	4	3	2	1	0
1	1	1	0	1	1	1	1	0	D	0	1	Vn				Vd				0	0	0	1	N	Q	M	1	Vm			
31	30	29	28	27	26	25	24	23	22	21	20	19	18	17	16	15	14	13	12	11	10	9	8	7	6	5	4	3	2	1	0
1	1	1	1	0	0	1	0	0	D	0	1	Vn				Vd				0	0	0	1	N	Q	M	1	Vm			

```
if Q == '1' && (Vd<0> == '1' || Vn<0> == '1' || Vm<0> == '1') then UNDEFINED;
d = UInt(D:Vd); n = UInt(N:Vn); m = UInt(M:Vm); regs = if Q == '0' then 1 else 2;
```

Assembler syntax

VBIC<c><q>{.<dt>} {<Qd>,<Qn>,<Qm>} Encoded as Q = 1
 VBIC<c><q>{.<dt>} {<Dd>,<Dn>,<Dm>} Encoded as Q = 0

where:

<c><q> See *Standard assembler syntax fields* on page A8-7. An ARM VBIC instruction must be unconditional.

<dt> An optional data type. It is ignored by assemblers, and does not affect the encoding.

<Qd>,<Qn>,<Qm> The destination vector and the operand vectors, for a quadword operation.

<Dd>,<Dn>,<Dm> The destination vector and the operand vectors, for a doubleword operation.

Operation

```
if ConditionPassed() then
    EncodingSpecificOperations(); CheckAdvSIMDEnabled();
    for r = 0 to regs-1
        D[d+r] = D[n+r] AND NOT(D[m+r]);
```

Exceptions

Undefined Instruction.

A8.6.279 VBIF, VBIT, VBSL

VBIF (Vector Bitwise Insert if False), VBIT (Vector Bitwise Insert if True), and VBSL (Vector Bitwise Select) perform bitwise selection under the control of a mask, and place the results in the destination register. The registers can be either quadword or doubleword, and must all be the same size.

Encoding T1 / A1 Advanced SIMD

V<op><c> <Qd>, <Qn>, <Qm>

V<op><c> <Dd>, <Dn>, <Dm>

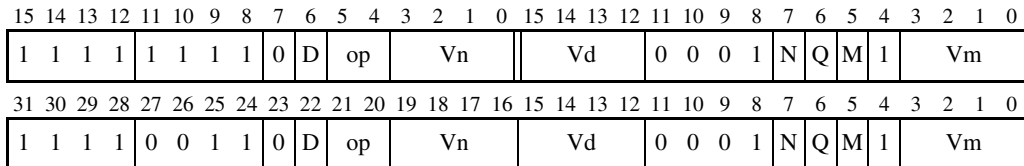

```

if Q == '1' && (Vd<0> == '1' || Vn<0> == '1' || Vm<0> == '1') then UNDEFINED;
if op == '00' then SEE VEOR;
if op == '01' then operation = VBitOps_VBSL;
if op == '10' then operation = VBitOps_VBIT;
if op == '11' then operation = VBitOps_VBIF;
d = UInt(D:Vd); n = UInt(N:Vn); m = UInt(M:Vm); regs = if Q == '0' then 1 else 2;
    
```

Assembler syntax

V<op><c><q>{.<dt>} {<Qd>,<Qn>,<Qm>} Encoded as Q = 1
 V<op><c><q>{.<dt>} {<Dd>,<Dn>,<Dm>} Encoded as Q = 0

where:

<op> The operation. It must be one of:

- BIF Bitwise Insert if False, encoded as op = 0b11. Inserts each bit from Vn into Vd if the corresponding bit of Vm is 0, otherwise leaves the Vd bit unchanged.
- BIT Bitwise Insert if True, encoded as op = 0b10. Inserts each bit from Vn into Vd if the corresponding bit of Vm is 1, otherwise leaves the Vd bit unchanged.
- BSL Bitwise Select, encoded as op = 0b01. Selects each bit from Vn into Vd if the corresponding bit of Vd is 1, otherwise selects the bit from Vm.

<c><q> See *Standard assembler syntax fields* on page A8-7. An ARM VBIF, VBIT, or VBSL instruction must be unconditional.

<dt> An optional data type. It is ignored by assemblers, and does not affect the encoding.

<Qd>,<Qn>,<Qm> The destination vector and the operand vectors, for a quadword operation.

<Dd>,<Dn>,<Dm> The destination vector and the operand vectors, for a doubleword operation.

Operation

```
enumeration VBitOps {VBitOps_VBIF, VBitOps_VBIT, VBitOps_VBSL};
```

```
if ConditionPassed() then
    EncodingSpecificOperations(); CheckAdvSIMDEnabled();
    for r = 0 to regs-1
        case operation of
            when VBitOps_VBIF D[d+r] = (D[d+r] AND D[m+r]) OR (D[n+r] AND NOT(D[m+r]));
            when VBitOps_VBIT D[d+r] = (D[n+r] AND D[m+r]) OR (D[d+r] AND NOT(D[m+r]));
            when VBitOps_VBSL D[d+r] = (D[n+r] AND D[d+r]) OR (D[m+r] AND NOT(D[d+r]));
```

Exceptions

Undefined Instruction.

A8.6.280 VCEQ (register)

VCEQ (Vector Compare Equal) takes each element in a vector, and compares it with the corresponding element of a second vector. If they are equal, the corresponding element in the destination vector is set to all ones. Otherwise, it is set to all zeros.

The operand vector elements can be any one of:

- 8-bit, 16-bit, or 32-bit integers. There is no distinction between signed and unsigned integers.
- 32-bit floating-point numbers.

The result vector elements are bitfields the same size as the operand vector elements.

Encoding T1 / A1 Advanced SIMD

VCEQ<c>.<dt> <Qd>, <Qn>, <Qm> <dt> an integer type

VCEQ<c>.<dt> <Dd>, <Dn>, <Dm> <dt> an integer type

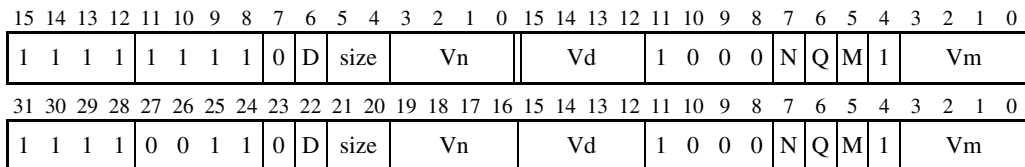

```

if Q == '1' && (Vd<0> == '1' || Vn<0> == '1' || Vm<0> == '1') then UNDEFINED;
if size == '11' then UNDEFINED;
int_operation = TRUE; esize = 8 << UInt(size); elements = 64 DIV esize;
d = UInt(D:Vd); n = UInt(N:Vn); m = UInt(M:Vm); regs = if Q == '0' then 1 else 2;
    
```

Encoding T2 / A2 Advanced SIMD (UNDEFINED in integer-only variant)

VCEQ<c>.<F32> <Qd>, <Qn>, <Qm>

VCEQ<c>.<F32> <Dd>, <Dn>, <Dm>

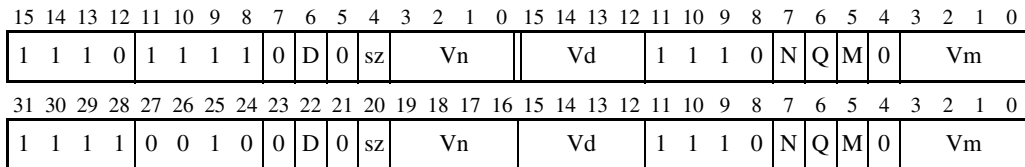

```

if Q == '1' && (Vd<0> == '1' || Vn<0> == '1' || Vm<0> == '1') then UNDEFINED;
if sz == '1' then UNDEFINED;
int_operation = FALSE; esize = 32; elements = 2;
d = UInt(D:Vd); n = UInt(N:Vn); m = UInt(M:Vm); regs = if Q == '0' then 1 else 2;
    
```

Assembler syntax

VCEQ<c><q>.<dt> {<Qd>}, <Qn>, <Qm> Encoded as Q = 1
 VCEQ<c><q>.<dt> {<Dd>}, <Dn>, <Dm> Encoded as Q = 0

where:

<c><q> See *Standard assembler syntax fields* on page A8-7. An ARM VCEQ instruction must be unconditional.

<dt> The data types for the elements of the operands. It must be one of:
 I8 encoding T1 / A1, size = 0b00
 I16 encoding T1 / A1, size = 0b01
 I32 encoding T1 / A1, size = 0b10
 F32 encoding T2 / A2, sz = 0.

<Qd>, <Qn>, <Qm> The destination vector and the operand vectors, for a quadword operation.

<Dd>, <Dn>, <Dm> The destination vector and the operand vectors, for a doubleword operation.

Operation

```

if ConditionPassed() then
    EncodingSpecificOperations(); CheckAdvSIMDEnabled();
    for r = 0 to regs-1
        for e = 0 to elements-1
            op1 = Elem[D[n+r],e,esize]; op2 = Elem[D[m+r],e,esize];
            if int_operation then
                test_passed = (op1 == op2);
            else
                test_passed = FPCompareEQ(op1, op2, FALSE);
            Elem[D[d+r],e,esize] = if test_passed then Ones(esize) else Zeros(esize);
  
```

Exceptions

Undefined Instruction.

Floating-point exceptions: Input Denormal and Invalid Operation.

A8.6.281 VCEQ (immediate #0)

VCEQ #0 (Vector Compare Equal to zero) takes each element in a vector, and compares it with zero. If it is equal to zero, the corresponding element in the destination vector is set to all ones. Otherwise, it is set to all zeros.

The operand vector elements can be any one of:

- 8-bit, 16-bit, or 32-bit integers. There is no distinction between signed and unsigned integers.
- 32-bit floating-point numbers.

The result vector elements are bitfields the same size as the operand vector elements.

Encoding T1 / A1 Advanced SIMD (F = 1 UNDEFINED in integer-only variants)

VCEQ<c>.<dt> <Qd>, <Qm>, #0

VCEQ<c>.<dt> <Dd>, <Dm>, #0

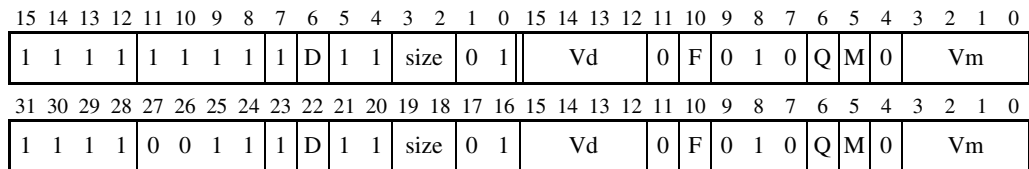

```

if size == '11' || (F == '1' && size != '10') then UNDEFINED;
if Q == '1' && (Vd<0> == '1' || Vm<0> == '1') then UNDEFINED;
floating_point = (F == '1');
esize = 8 << UInt(size); elements = 64 DIV esize;
d = UInt(D:Vd); m = UInt(M:Vm); regs = if Q == '0' then 1 else 2;
    
```

Assembler syntax

VCEQ<c><q>.<dt> {<Qd>,<Qm>,<#0> Encoded as Q = 1
 VCEQ<c><q>.<dt> {<Dd>,<Dm>,<#0> Encoded as Q = 0

where:

<c><q> See *Standard assembler syntax fields* on page A8-7. An ARM VCEQ instruction must be unconditional.

<dt> The data types for the elements of the operands. It must be one of:
 I8 encoded as size = 0b00, F = 0
 I16 encoded as size = 0b01, F = 0
 I32 encoded as size = 0b10, F = 0
 F32 encoded as size = 0b10, F = 1.

<Qd>,<Qm> The destination vector and the operand vector, for a quadword operation.

<Dd>,<Dm> The destination vector and the operand vector, for a doubleword operation.

Operation

```

if ConditionPassed() then
    EncodingSpecificOperations(); CheckAdvSIMDEnabled();
    for r = 0 to regs-1
        for e = 0 to elements-1
            if floating_point then
                test_passed = FPCompareEQ(Elem[D[m+r],e,esize], FPZero('0',esize), FALSE);
            else
                test_passed = (Elem[D[m+r],e,esize] == Zeros(esize));
            Elem[D[d+r],e,esize] = if test_passed then Ones(esize) else Zeros(esize);
  
```

Exceptions

Undefined Instruction.

Floating-point exceptions: Input Denormal and Invalid Operation.

A8.6.282 VCGE (register)

VCGE (Vector Compare Greater Than or Equal) takes each element in a vector, and compares it with the corresponding element of a second vector. If the first is greater than or equal to the second, the corresponding element in the destination vector is set to all ones. Otherwise, it is set to all zeros.

The operand vector elements can be any one of:

- 8-bit, 16-bit, or 32-bit signed integers
- 8-bit, 16-bit, or 32-bit unsigned integers
- 32-bit floating-point numbers.

The result vector elements are bitfields the same size as the operand vector elements.

Encoding T1 / A1 Advanced SIMD

VCGE<c>.<dt> <Qd>, <Qn>, <Qm> <dt> an integer type

VCGE<c>.<dt> <Dd>, <Dn>, <Dm> <dt> an integer type

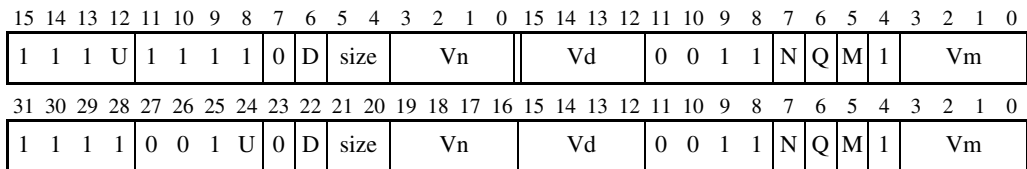

```

if Q == '1' && (Vd<0> == '1' || Vn<0> == '1' || Vm<0> == '1') then UNDEFINED;
if size == '11' then UNDEFINED;
type = if U == '1' then VCGEtype_unsigned else VCGEtype_signed;
esize = 8 << UInt(size); elements = 64 DIV esize;
d = UInt(D:Vd); n = UInt(N:Vn); m = UInt(M:Vm); regs = if Q == '0' then 1 else 2;
    
```

Encoding T2 / A2 Advanced SIMD (UNDEFINED in integer-only variant)

VCGE<c>.F32 <Qd>, <Qn>, <Qm>

VCGE<c>.F32 <Dd>, <Dn>, <Dm>

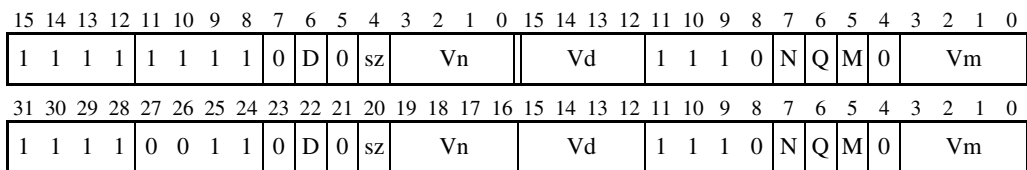

```

if Q == '1' && (Vd<0> == '1' || Vn<0> == '1' || Vm<0> == '1') then UNDEFINED;
if sz == '1' then UNDEFINED;
type = VCGEtype_fp; esize = 32; elements = 2;
d = UInt(D:Vd); n = UInt(N:Vn); m = UInt(M:Vm); regs = if Q == '0' then 1 else 2;
    
```

Assembler syntax

VCGE<c><q>.<dt> {<Qd>,<Qn>,<Qm> Encoded as Q = 1
 VCGE<c><q>.<dt> {<Dd>,<Dn>,<Dm> Encoded as Q = 0

where:

<c><q> See *Standard assembler syntax fields* on page A8-7. An ARM VCGE instruction must be unconditional.

<dt> The data types for the elements of the operands. It must be one of:

S8	encoding T1 / A1, size = 0b00, U = 0
S16	encoding T1 / A1, size = 0b01, U = 0
S32	encoding T1 / A1, size = 0b10, U = 0
U8	encoding T1 / A1, size = 0b00, U = 1
U16	encoding T1 / A1, size = 0b01, U = 1
U32	encoding T1 / A1, size = 0b10, U = 1
F32	encoding T2 / A2, sz = 0.

<Qd>, <Qn>, <Qm> The destination vector and the operand vectors, for a quadword operation.

<Dd>, <Dn>, <Dm> The destination vector and the operand vectors, for a doubleword operation.

Operation

```
enumeration VCGEtype {VCGEtype_signed, VCGEtype_unsigned, VCGEtype_fp};
```

```
if ConditionPassed() then
  EncodingSpecificOperations(); CheckAdvSIMDEnabled();
  for r = 0 to regs-1
    for e = 0 to elements-1
      op1 = Elem[D[n+r],e,esize]; op2 = Elem[D[m+r],e,esize];
      case type of
        when VCGEtype_signed test_passed = (SInt(op1) >= SInt(op2));
        when VCGEtype_unsigned test_passed = (UInt(op1) >= UInt(op2));
        when VCGEtype_fp test_passed = FPCompareGE(op1, op2, FALSE);
      Elem[D[d+r],e,esize] = if test_passed then Ones(esize) else Zeros(esize);
```

Exceptions

Undefined Instruction.

Floating-point exceptions: Input Denormal and Invalid Operation.

A8.6.283 VCGE (immediate #0)

VCGE #0 (Vector Compare Greater Than or Equal to Zero) take each element in a vector, and compares it with zero. If it is greater than or equal to zero, the corresponding element in the destination vector is set to all ones. Otherwise, it is set to all zeros.

The operand vector elements can be any one of:

- 8-bit, 16-bit, or 32-bit signed integers
- 32-bit floating-point numbers.

The result vector elements are bitfields the same size as the operand vector elements.

Encoding T1 / A1 Advanced SIMD (F = 1 UNDEFINED in integer-only variants)

VCGE<c>.<dt> <Qd>, <Qm>, #0

VCGE<c>.<dt> <Dd>, <Dm>, #0

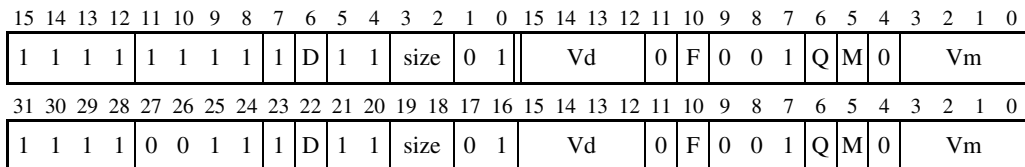

```

if size == '11' || (F == '1' && size != '10') then UNDEFINED;
if Q == '1' && (Vd<0> == '1' || Vm<0> == '1') then UNDEFINED;
floating_point = (F == '1');
esize = 8 << UInt(size); elements = 64 DIV esize;
d = UInt(D:Vd); m = UInt(M:Vm); regs = if Q == '0' then 1 else 2;
    
```

Assembler syntax

VCGE<c><q>.<dt> {<Qd>,<Qm>,<#0> Encoded as Q = 1
 VCGE<c><q>.<dt> {<Dd>,<Dm>,<#0> Encoded as Q = 0

where:

<c><q> See *Standard assembler syntax fields* on page A8-7. An ARM VCGE instruction must be unconditional.

<dt> The data types for the elements of the operands. It must be one of:
 S8 encoded as size = 0b00, F = 0
 S16 encoded as size = 0b01, F = 0
 S32 encoded as size = 0b10, F = 0
 F32 encoded as size = 0b10, F = 1.

<Qd>, <Qm> The destination vector and the operand vector, for a quadword operation.

<Dd>, <Dm> The destination vector and the operand vector, for a doubleword operation.

Operation

```
if ConditionPassed() then
    EncodingSpecificOperations(); CheckAdvSIMDEnabled();
    for r = 0 to regs-1
        for e = 0 to elements-1
            if floating_point then
                test_passed = FPCompareGE(Elem[D[m+r],e,esize], FPZero('0',esize), FALSE);
            else
                test_passed = (SInt(Elem[D[m+r],e,esize]) >= 0);
            Elem[D[d+r],e,esize] = if test_passed then Ones(esize) else Zeros(esize);
```

Exceptions

Undefined Instruction.

Floating-point exceptions: Input Denormal and Invalid Operation.

A8.6.284 VCGT (register)

VCGT (Vector Compare Greater Than) takes each element in a vector, and compares it with the corresponding element of a second vector. If the first is greater than the second, the corresponding element in the destination vector is set to all ones. Otherwise, it is set to all zeros.

The operand vector elements can be any one of:

- 8-bit, 16-bit, or 32-bit signed integers
- 8-bit, 16-bit, or 32-bit unsigned integers
- 32-bit floating-point numbers.

The result vector elements are bitfields the same size as the operand vector elements.

Encoding T1 / A1 Advanced SIMD

VCGT<c>.<dt> <Qd>, <Qn>, <Qm> <dt> an integer type

VCGT<c>.<dt> <Dd>, <Dn>, <Dm> <dt> an integer type

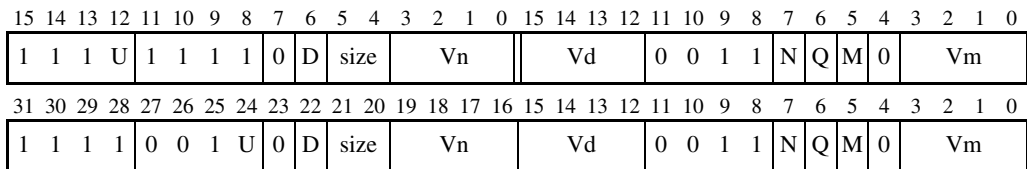

```

if Q == '1' && (Vd<0> == '1' || Vn<0> == '1' || Vm<0> == '1') then UNDEFINED;
if size == '11' then UNDEFINED;
type = if U == '1' then VCGTtype_unsigned else VCGTtype_signed;
esize = 8 << UInt(size); elements = 64 DIV esize;
d = UInt(D:Vd); n = UInt(N:Vn); m = UInt(M:Vm); regs = if Q == '0' then 1 else 2;
    
```

Encoding T2 / A2 Advanced SIMD (UNDEFINED in integer-only variant)

VCGT<c>.<F32> <Qd>, <Qn>, <Qm>

VCGT<c>.<F32> <Dd>, <Dn>, <Dm>

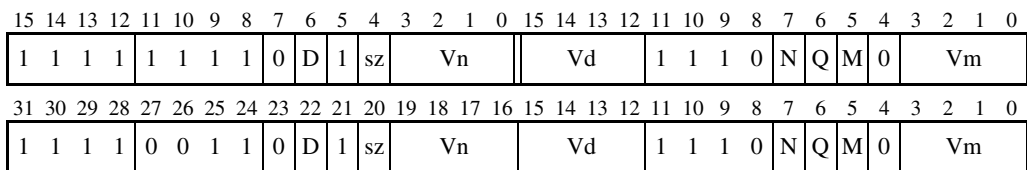

```

if Q == '1' && (Vd<0> == '1' || Vn<0> == '1' || Vm<0> == '1') then UNDEFINED;
if sz == '1' then UNDEFINED;
type = VCGTtype_fp; esize = 32; elements = 2;
d = UInt(D:Vd); n = UInt(N:Vn); m = UInt(M:Vm); regs = if Q == '0' then 1 else 2;
    
```

Assembler syntax

VCGT<c><q>.<dt> {<Qd>,<Qn>,<Qm> Encoded as Q = 1
 VCGT<c><q>.<dt> {<Dd>,<Dn>,<Dm> Encoded as Q = 0

where:

<c><q> See *Standard assembler syntax fields* on page A8-7. An ARM VCGT instruction must be unconditional.

<dt> The data types for the elements of the operands. It must be one of:

S8	encoding T1 / A1, size = 0b00, U = 0
S16	encoding T1 / A1, size = 0b01, U = 0
S32	encoding T1 / A1, size = 0b10, U = 0
U8	encoding T1 / A1, size = 0b00, U = 1
U16	encoding T1 / A1, size = 0b01, U = 1
U32	encoding T1 / A1, size = 0b10, U = 1
F32	encoding T2 / A2, sz = 0.

<Qd>, <Qn>, <Qm> The destination vector and the operand vectors, for a quadword operation.

<Dd>, <Dn>, <Dm> The destination vector and the operand vectors, for a doubleword operation.

Operation

```
enumeration VCGTtype {VCGTtype_signed, VCGTtype_unsigned, VCGTtype_fp};
```

```
if ConditionPassed() then
  EncodingSpecificOperations(); CheckAdvSIMDEnabled();
  for r = 0 to regs-1
    for e = 0 to elements-1
      op1 = Elem[D[n+r],e,esize]; op2 = Elem[D[m+r],e,esize];
      case type of
        when VCGTtype_signed test_passed = (SInt(op1) > SInt(op2));
        when VCGTtype_unsigned test_passed = (UInt(op1) > UInt(op2));
        when VCGTtype_fp test_passed = FPCompareGT(op1, op2, FALSE);
      Elem[D[d+r],e,esize] = if test_passed then Ones(esize) else Zeros(esize);
```

Exceptions

Undefined Instruction.

Floating-point exceptions: Input Denormal and Invalid Operation.

A8.6.285 VCGT (immediate #0)

VCGT #0 (Vector Compare Greater Than Zero) take each element in a vector, and compares it with zero. If it is greater than zero, the corresponding element in the destination vector is set to all ones. Otherwise, it is set to all zeros.

The operand vector elements can be any one of:

- 8-bit, 16-bit, or 32-bit signed integers
- 32-bit floating-point numbers.

The result vector elements are bitfields the same size as the operand vector elements.

Encoding T1 / A1 Advanced SIMD (F = 1 UNDEFINED in integer-only variants)

VCGT<c>.<dt> <Qd>, <Qm>, #0

VCGT<c>.<dt> <Dd>, <Dm>, #0

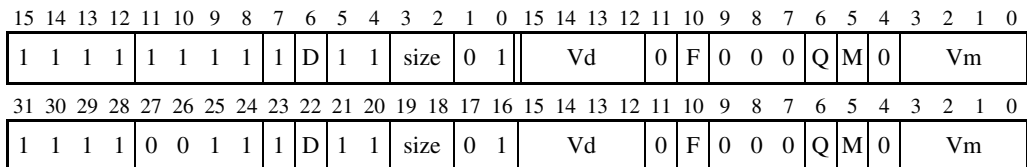

```

if size == '11' || (F == '1' && size != '10') then UNDEFINED;
if Q == '1' && (Vd<0> == '1' || Vm<0> == '1') then UNDEFINED;
floating_point = (F == '1');
esize = 8 << UInt(size); elements = 64 DIV esize;
d = UInt(D:Vd); m = UInt(M:Vm); regs = if Q == '0' then 1 else 2;
    
```

Assembler syntax

VCGT<c><q>.<dt> {<Qd>,<Qm>,<#0> Encoded as Q = 1
 VCGT<c><q>.<dt> {<Dd>,<Dm>,<#0> Encoded as Q = 0

where:

<c><q> See *Standard assembler syntax fields* on page A8-7. An ARM VCGT instruction must be unconditional.

<dt> The data types for the elements of the operands. It must be one of:
 S8 encoded as size = 0b00, F = 0
 S16 encoded as size = 0b01, F = 0
 S32 encoded as size = 0b10, F = 0
 F32 encoded as size = 0b10, F = 1.

<Qd>, <Qm> The destination vector and the operand vector, for a quadword operation.

<Dd>, <Dm> The destination vector and the operand vector, for a doubleword operation.

Operation

```
if ConditionPassed() then
  EncodingSpecificOperations(); CheckAdvSIMDEnabled();
  for r = 0 to regs-1
    for e = 0 to elements-1
      if floating_point then
        test_passed = FPCompareGT(Elem[D[m+r],e,esize], FPZero('0',esize), FALSE);
      else
        test_passed = (SInt(Elem[D[m+r],e,esize]) > 0);
      Elem[D[d+r],e,esize] = if test_passed then Ones(esize) else Zeros(esize);
```

Exceptions

Undefined Instruction.

Floating-point exceptions: Input Denormal and Invalid Operation.

A8.6.286 VCLE (register)

VCLE is a pseudo-instruction, equivalent to a VCGE instruction with the operands reversed. For details see *VCGE (register)* on page A8-556.

A8.6.287 VCLE (immediate #0)

VCLE #0 (Vector Compare Less Than or Equal to Zero) take each element in a vector, and compares it with zero. If it is less than or equal to zero, the corresponding element in the destination vector is set to all ones. Otherwise, it is set to all zeros.

The operand vector elements can be any one of:

- 8-bit, 16-bit, or 32-bit signed integers
- 32-bit floating-point numbers.

The result vector elements are bitfields the same size as the operand vector elements.

Encoding T1 / A1 Advanced SIMD (F = 1 UNDEFINED in integer-only variants)

VCLE<c>.<dt> <Qd>, <Qm>, #0

VCLE<c>.<dt> <Dd>, <Dm>, #0

15	14	13	12	11	10	9	8	7	6	5	4	3	2	1	0	15	14	13	12	11	10	9	8	7	6	5	4	3	2	1	0
1	1	1	1	1	1	1	1	D	1	1	size	0	1	Vd	0	F	0	1	1	Q	M	0	Vm								
31	30	29	28	27	26	25	24	23	22	21	20	19	18	17	16	15	14	13	12	11	10	9	8	7	6	5	4	3	2	1	0
1	1	1	1	0	0	1	1	1	D	1	1	size	0	1	Vd	0	F	0	1	1	Q	M	0	Vm							

```

if size == '11' || (F == '1' && size != '10') then UNDEFINED;
if Q == '1' && (Vd<0> == '1' || Vm<0> == '1') then UNDEFINED;
floating_point = (F == '1');
esize = 8 << UInt(size); elements = 64 DIV esize;
d = UInt(D:Vd); m = UInt(M:Vm); regs = if Q == '0' then 1 else 2;
    
```

Assembler syntax

VCLE<c><q>.<dt> {<Qd>}, <Qm>, #0 Encoded as Q = 1
 VCLE<c><q>.<dt> {<Dd>}, <Dm>, #0 Encoded as Q = 0

where:

<c><q> See *Standard assembler syntax fields* on page A8-7. An ARM VCLE instruction must be unconditional.

<dt> The data types for the elements of the operands. It must be one of:
 S8 encoded as size = 0b00, F = 0
 S16 encoded as size = 0b01, F = 0
 S32 encoded as size = 0b10, F = 0
 F32 encoded as size = 0b10, F = 1.

<Qd>, <Qm> The destination vector and the operand vector, for a quadword operation.

<Dd>, <Dm> The destination vector and the operand vector, for a doubleword operation.

Operation

```
if ConditionPassed() then
  EncodingSpecificOperations(); CheckAdvSIMDEnabled();
  for r = 0 to regs-1
    for e = 0 to elements-1
      if floating_point then
        test_passed = FPCompareGE(FPZero('0', esize), Elem[D[m+r], e, esize], FALSE);
      else
        test_passed = (SInt(Elem[D[m+r], e, esize]) <= 0);
      Elem[D[d+r], e, esize] = if test_passed then Ones(esize) else Zeros(esize);
```

Exceptions

Undefined Instruction.

Floating-point exceptions: Input Denormal and Invalid Operation.

A8.6.288 VCLS

Vector Count Leading Sign Bits counts the number of consecutive bits following the topmost bit, that are the same as the topmost bit, in each element in a vector, and places the results in a second vector. The count does not include the topmost bit itself.

The operand vector elements can be any one of 8-bit, 16-bit, or 32-bit signed integers.

The result vector elements are the same data type as the operand vector elements.

Encoding T1 / A1 Advanced SIMD

VCLS<c>.<dt> <Qd>, <Qm>

VCLS<c>.<dt> <Dd>, <Dm>

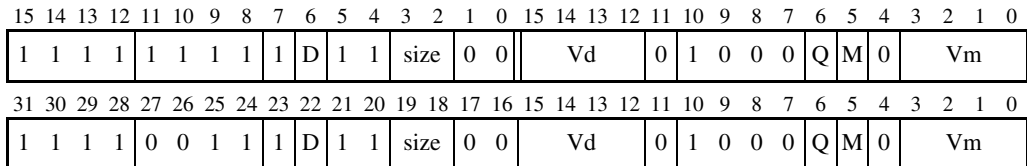

```

if size == '11' then UNDEFINED;
if Q == '1' && (Vd<0> == '1' || Vm<0> == '1') then UNDEFINED;
esize = 8 << UInt(size); elements = 64 DIV esize;
d = UInt(D:Vd); m = UInt(M:Vm); regs = if Q == '0' then 1 else 2;
    
```

Assembler syntax

VCLS<c><q>.<dt> <Qd>, <Qm> Encoded as Q = 1
 VCLS<c><q>.<dt> <Dd>, <Dm> Encoded as Q = 0

where:

<c><q> See *Standard assembler syntax fields* on page A8-7. An ARM VCLS instruction must be unconditional.

<dt> The data size for the elements of the operands. It must be one of:

S8 encoded as size = 0b00

S16 encoded as size = 0b01

S32 encoded as size = 0b10.

<Qd>, <Qm> The destination vector and the operand vector, for a quadword operation.

<Dd>, <Dm> The destination vector and the operand vector, for a doubleword operation.

Operation

```
if ConditionPassed() then
    EncodingSpecificOperations(); CheckAdvSIMDEnabled();
    for r = 0 to regs-1
        for e = 0 to elements-1
            Elem[D[d+r],e,esize] = CountLeadingSignBits(Elem[D[m+r],e,esize]);
```

Exceptions

Undefined Instruction.

A8.6.289 VCLT (register)

VCLT is a pseudo-instruction, equivalent to a VCGT instruction with the operands reversed. For details see *VCGT (register)* on page A8-560.

A8.6.290 VCLT (immediate #0)

VCLT #0 (Vector Compare Less Than Zero) take each element in a vector, and compares it with zero. If it is less than zero, the corresponding element in the destination vector is set to all ones. Otherwise, it is set to all zeros.

The operand vector elements can be any one of:

- 8-bit, 16-bit, or 32-bit signed integers
- 32-bit floating-point numbers.

The result vector elements are bitfields the same size as the operand vector elements.

Encoding T1 / A1 Advanced SIMD (F = 1 UNDEFINED in integer-only variants)

VCLT<c>.<dt> <Qd>, <Qm>, #0

VCLT<c>.<dt> <Dd>, <Dm>, #0

15	14	13	12	11	10	9	8	7	6	5	4	3	2	1	0	15	14	13	12	11	10	9	8	7	6	5	4	3	2	1	0
1	1	1	1	1	1	1	1	D	1	1	size	0	1	Vd		0	F	1	0	0	Q	M	0	Vm							
31	30	29	28	27	26	25	24	23	22	21	20	19	18	17	16	15	14	13	12	11	10	9	8	7	6	5	4	3	2	1	0
1	1	1	1	0	0	1	1	1	D	1	1	size	0	1	Vd		0	F	1	0	0	Q	M	0	Vm						

```

if size == '11' || (F == '1' && size != '10') then UNDEFINED;
if Q == '1' && (Vd<0> == '1' || Vm<0> == '1') then UNDEFINED;
floating_point = (F == '1');
esize = 8 << UInt(size); elements = 64 DIV esize;
d = UInt(D:Vd); m = UInt(M:Vm); regs = if Q == '0' then 1 else 2;
    
```

Assembler syntax

VCLT<c><q>.<dt> {<Qd>,<Qm>,<#0> Encoded as Q = 1
 VCLT<c><q>.<dt> {<Dd>,<Dm>,<#0> Encoded as Q = 0

where:

<c><q> See *Standard assembler syntax fields* on page A8-7. An ARM VCLT instruction must be unconditional.

<dt> The data types for the elements of the operands. It must be one of:
 S8 encoded as size = 0b00, F = 0
 S16 encoded as size = 0b01, F = 0
 S32 encoded as size = 0b10, F = 0
 F32 encoded as size = 0b10, F = 1.

<Qd>,<Qm> The destination vector and the operand vector, for a quadword operation.

<Dd>,<Dm> The destination vector and the operand vector, for a doubleword operation.

Operation

```

if ConditionPassed() then
    EncodingSpecificOperations(); CheckAdvSIMDEnabled();
    for r = 0 to regs-1
        for e = 0 to elements-1
            if floating_point then
                test_passed = FPCompareGT(FPZero('0',esize), Elem[D[m+r],e,esize], FALSE);
            else
                test_passed = (SInt(Elem[D[m+r],e,esize]) < 0);
            Elem[D[d+r],e,esize] = if test_passed then Ones(esize) else Zeros(esize);
  
```

Exceptions

Undefined Instruction.

Floating-point exceptions: Input Denormal and Invalid Operation.

A8.6.291 VCLZ

Vector Count Leading Zeros counts the number of consecutive zeros, starting from the most significant bit, in each element in a vector, and places the results in a second vector.

The operand vector elements can be any one of 8-bit, 16-bit, or 32-bit integers. There is no distinction between signed and unsigned integers.

The result vector elements are the same data type as the operand vector elements.

Encoding T1 / A1 Advanced SIMD

VCLZ<c>.<dt> <Qd>, <Qm>

VCLZ<c>.<dt> <Dd>, <Dm>

15	14	13	12	11	10	9	8	7	6	5	4	3	2	1	0	15	14	13	12	11	10	9	8	7	6	5	4	3	2	1	0
1	1	1	1	1	1	1	1	D	1	1	size	0	0	Vd	0	1	0	0	1	Q	M	0	Vm								
31	30	29	28	27	26	25	24	23	22	21	20	19	18	17	16	15	14	13	12	11	10	9	8	7	6	5	4	3	2	1	0
1	1	1	1	0	0	1	1	1	D	1	1	size	0	0	Vd	0	1	0	0	1	Q	M	0	Vm							

```

if size == '11' then UNDEFINED;
if Q == '1' && (Vd<0> == '1' || Vm<0> == '1') then UNDEFINED;
esize = 8 << UInt(size); elements = 64 DIV esize;
d = UInt(D:Vd); m = UInt(M:Vm); regs = if Q == '0' then 1 else 2;
    
```

Assembler syntax

VCLZ<c><q>.<dt> <Qd>, <Qm> Encoded as Q = 1
 VCLZ<c><q>.<dt> <Dd>, <Dm> Encoded as Q = 0

where:

<c><q> See *Standard assembler syntax fields* on page A8-7. An ARM VCLZ instruction must be unconditional.

<dt> The data size for the elements of the operands. It must be one of:

I8 encoded as size = 0b00

I16 encoded as size = 0b01

I32 encoded as size = 0b10.

<Qd>, <Qm> The destination vector and the operand vector, for a quadword operation.

<Dd>, <Dm> The destination vector and the operand vector, for a doubleword operation.

Operation

```
if ConditionPassed() then
    EncodingSpecificOperations(); CheckAdvSIMDEnabled();
    for r = 0 to regs-1
        for e = 0 to elements-1
            Elem[D[d+r],e,esize] = CountLeadingZeroBits(Elem[D[m+r],e,esize]);
```

Exceptions

Undefined Instruction.

A8.6.292 VCMP, VCMPE

This instruction compares two floating-point registers, or one floating-point register and zero. It writes the result to the FPSCR flags. These are normally transferred to the ARM flags by a subsequent VMRS instruction.

It can optionally raise an Invalid Operation exception if either operand is any type of NaN. It always raises an Invalid Operation exception if either operand is a signaling NaN.

Encoding T1 / A1 VFPv2, VFPv3 (sz = 1 UNDEFINED in single-precision only variants)

VCMP{E}<c>.F64 <Dd>, <Dm>

VCMP{E}<c>.F32 <Sd>, <Sm>

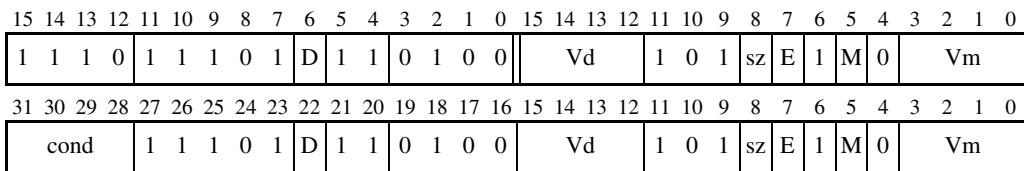

dp_operation = (sz == '1'); quiet_nan_exc = (E == '1'); with_zero = FALSE;

d = if dp_operation then UInt(D:Vd) else UInt(Vd:D);

m = if dp_operation then UInt(M:Vm) else UInt(Vm:M);

Encoding T2 / A2 VFPv2, VFPv3 (sz = 1 UNDEFINED in single-precision only variants)

VCMP{E}<c>.F64 <Dd>, #0.0

VCMP{E}<c>.F32 <Sd>, #0.0

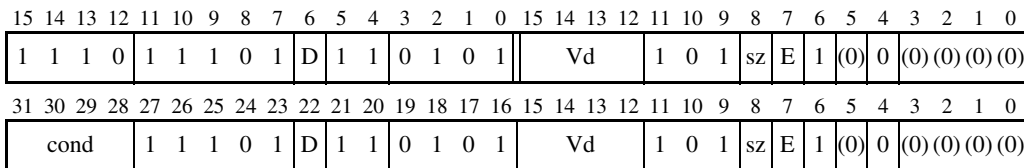

dp_operation = (sz == '1'); quiet_nan_exc = (E == '1'); with_zero = TRUE;

d = if dp_operation then UInt(D:Vd) else UInt(Vd:D);

Assembler syntax

VCMP{E}<c><q>.F64 <Dd>, <Dm>	Encoding T1 / A1, sz = 1
VCMP{E}<c><q>.F32 <Sd>, <Sm>	Encoding T1 / A1, sz = 0
VCMP{E}<c><q>.F64 <Dd>, #0.0	Encoding T2 / A2, sz = 1
VCMP{E}<c><q>.F32 <Sd>, #0.0	Encoding T2 / A2, sz = 0

where:

E If present, any NaN operand causes an Invalid Operation exception. Encoded as E = 1.
 Otherwise, only a signaling NaN causes the exception. Encoded as E = 0.

<c><q> See *Standard assembler syntax fields* on page A8-7.

<Dd>, <Dm> The operand vectors, for a doubleword operation.

<Sd>, <Sm> The operand vectors, for a singleword operation.

Operation

```

if ConditionPassed() then
    EncodingSpecificOperations(); CheckVFPEnabled(TRUE);
    if dp_operation then
        op2 = if with_zero then FPZero('0',64) else D[m];
        (FPSCR.N, FPSCR.Z, FPSCR.C, FPSCR.V) = FPCompare(D[d], op2, quiet_nan_exc, TRUE);
    else
        op2 = if with_zero then FPZero('0',32) else S[m];
        (FPSCR.N, FPSCR.Z, FPSCR.C, FPSCR.V) = FPCompare(S[d], op2, quiet_nan_exc, TRUE);

```

Exceptions

Undefined Instruction.

Floating-point exceptions: Invalid Operation, Input Denormal.

NaNs

The IEEE 754 standard specifies that the result of a comparison is precisely one of <, ==, > or *unordered*. If either or both of the operands are NaNs, they are unordered, and all three of (Operand1 < Operand2), (Operand1 == Operand2) and (Operand1 > Operand2) are false. This results in the FPSCR flags being set as N=0, Z=0, C=1 and V=1.

VCMP{E} raises an Invalid Operation exception if either operand is any type of NaN, and is suitable for testing for <, <=, >, >=, and other predicates that raise an exception when the operands are unordered.

A8.6.293 VCNT

This instruction counts the number of bits that are one in each element in a vector, and places the results in a second vector.

The operand vector elements must be 8-bit bitfields.

The result vector elements are 8-bit integers.

Encoding T1 / A1 Advanced SIMD

VCNT<c>.8 <Qd>, <Qm>

VCNT<c>.8 <Dd>, <Dm>

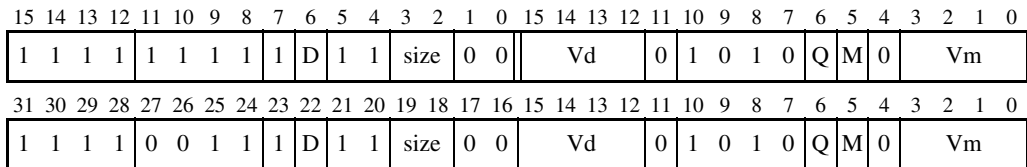

```

if size != '00' then UNDEFINED;
if Q == '1' && (Vd<0> == '1' || Vm<0> == '1') then UNDEFINED;
esize = 8; elements = 8;
d = UInt(D:Vd); m = UInt(M:Vm); regs = if Q == '0' then 1 else 2;
    
```

Assembler syntax

VCNT<c><q>.8 <Qd>, <Qm> Encoded as Q = 1
 VCNT<c><q>.8 <Dd>, <Dm> Encoded as Q = 0

where:

<c><q> See *Standard assembler syntax fields* on page A8-7. An ARM VCNT instruction must be unconditional.

<Qd>, <Qm> The destination vector and the operand vector, for a quadword operation.

<Dd>, <Dm> The destination vector and the operand vector, for a doubleword operation.

Operation

```
if ConditionPassed() then
    EncodingSpecificOperations(); CheckAdvSIMDEnabled();
    for r = 0 to regs-1
        for e = 0 to elements-1
            Elem[D[d+r],e,esize] = BitCount(Elem[D[m+r],e,esize]);
```

Exceptions

Undefined Instruction.

A8.6.294 VCVT (between floating-point and integer, Advanced SIMD)

This instruction converts each element in a vector from floating-point to integer, or from integer to floating-point, and places the results in a second vector.

The vector elements must be 32-bit floating-point numbers, or 32-bit integers. Signed and unsigned integers are distinct.

The floating-point to integer operation uses the Round towards Zero rounding mode. The integer to floating-point operation uses the Round to Nearest rounding mode.

Encoding T1 / A1 Advanced SIMD (UNDEFINED in integer-only variant)

VCVT<c>.<Td>.<Tm> <Qd>, <Qm>

VCVT<c>.<Td>.<Tm> <Dd>, <Dm>

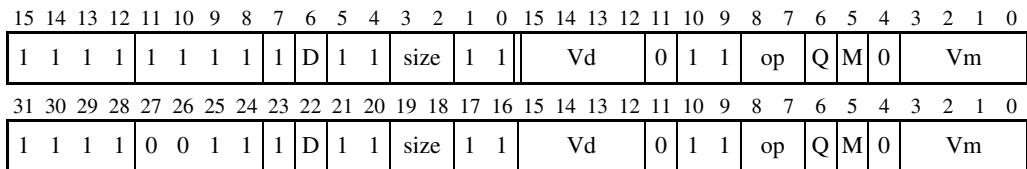

```

if Q == '1' && (Vd<0> == '1' || Vm<0> == '1') then UNDEFINED;
if size != '10' then UNDEFINED;
to_integer = (op<1> == '1'); unsigned = (op<0> == '1'); esize = 32; elements = 2;
if to_integer then
    round_zero = TRUE; // Variable name indicates purpose of FPToFixed() argument
else
    round_nearest = TRUE; // Variable name indicates purpose of FixedToFP() argument
d = UInt(D:Vd); m = UInt(M:Vm); regs = if Q == '0' then 1 else 2;
    
```

Assembler syntax

VCVT<c><q>.<Td>.<Tm> <Qd>, <Qm> Encoded as Q = 1
 VCVT<c><q>.<Td>.<Tm> <Dd>, <Dm> Encoded as Q = 0

where:

<c><q> See *Standard assembler syntax fields* on page A8-7. An ARM Advanced SIMD VCVT instruction must be unconditional.

.<Td>.<Tm> The data types for the elements of the vectors. They must be one of:

.S32.F32 encoded as op = 0b10, size = 0b10

.U32.F32 encoded as op = 0b11, size = 0b10

.F32.S32 encoded as op = 0b00, size = 0b10

.F32.U32 encoded as op = 0b01, size = 0b10.

<Qd>, <Qm> The destination vector and the operand vector, for a quadword operation.

<Dd>, <Dm> The destination vector and the operand vector, for a doubleword operation.

Operation

```
if ConditionPassed() then
    EncodingSpecificOperations(); CheckAdvSIMDEnabled();
    for r = 0 to regs-1
        for e = 0 to elements-1
            op = Elem[D[m+r],e,esize];
            if to_integer then
                result = FPToFixed(op, esize, 0, unsigned, round_zero, FALSE);
            else
                result = FixedToFP(op, esize, 0, unsigned, round_nearest, FALSE);
            Elem[D[d+r],e,esize] = result;
```

Exceptions

Undefined Instruction.

Floating-point exceptions: Input Denormal, Invalid Operation, and Inexact.

A8.6.295 VCVT, VCVTR (between floating-point and integer, VFP)

These instructions convert a value in a register from floating-point to a 32-bit integer, or from a 32-bit integer to floating-point, and place the result in a second register.

The floating-point to integer operation normally uses the Round towards Zero rounding mode, but can optionally use the rounding mode specified by the FPSCR. The integer to floating-point operation uses the rounding mode specified by the FPSCR.

VCVT (between floating-point and fixed-point, VFP) on page A8-582 describes conversions between floating-point and 16-bit integers.

Encoding T1 / A1 VFPv2, VFPv3 (sz = 1 UNDEFINED in single-precision only variants)

VCVT{R}<c>.S32.F64 <Sd>, <Dm>

VCVT{R}<c>.S32.F32 <Sd>, <Sm>

VCVT{R}<c>.U32.F64 <Sd>, <Dm>

VCVT{R}<c>.U32.F32 <Sd>, <Sm>

VCVT<c>.F64.<Tm> <Dd>, <Sm>

VCVT<c>.F32.<Tm> <Sd>, <Sm>

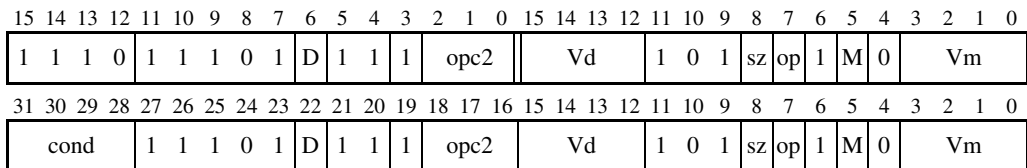

```

if opc2 != '000' && opc2 != '10x' then SEE "Related encodings";
to_integer = (opc2<2> == '1'); dp_operation = (sz == 1);
if to_integer then
    unsigned = (opc2<0> == '0'); round_zero = (op == '1');
    d = UInt(Vd:D); m = if dp_operation then UInt(M:Vm) else UInt(Vm:M);
else
    unsigned = (op == '0'); round_fpscr = FALSE; // FALSE selects FPSCR rounding
    m = UInt(Vm:M); d = if dp_operation then UInt(D:Vd) else UInt(Vd:D);
    
```

Related encodings See *VFP data-processing instructions* on page A7-24

Assembler syntax

VCVT{R}<c><q>.S32.F64 <Sd>, <Dm>	opc2 = '101', sz = 1
VCVT{R}<c><q>.S32.F32 <Sd>, <Sm>	opc2 = '101', sz = 0
VCVT{R}<c><q>.U32.F64 <Sd>, <Dm>	opc2 = '100', sz = 1
VCVT{R}<c><q>.U32.F32 <Sd>, <Sm>	opc2 = '100', sz = 0
VCVT<c><q>.F64.<Tm> <Dd>, <Sm>	opc2 = '000', sz = 1
VCVT<c><q>.F32.<Tm> <Sd>, <Sm>	opc2 = '000', sz = 0

where:

R	If R is specified, the operation uses the rounding mode specified by the FPSCR. Encoded as op = 0. If R is omitted, the operation uses the Round towards Zero rounding mode. For syntaxes in which R is optional, op is encoded as 1 if R is omitted.
<c><q>	See <i>Standard assembler syntax fields</i> on page A8-7.
<Tm>	The data type for the operand. It must be one of: S32 encoded as op = 1 U32 encoded as op = 0.
<Sd>, <Dm>	The destination register and the operand register, for a double-precision operand.
<Dd>, <Sm>	The destination register and the operand register, for a double-precision result.
<Sd>, <Sm>	The destination register and the operand register, for a single-precision operand or result.

Operation

```

if ConditionPassed() then
    EncodingSpecificOperations(); CheckVFPEnabled(TRUE);
    if to_integer then
        if dp_operation then
            S[d] = FPToFixed(D[m], 32, 0, unsigned, round_zero, TRUE);
        else
            S[d] = FPToFixed(S[m], 32, 0, unsigned, round_zero, TRUE);
    else
        if dp_operation then
            D[d] = FixedToFP(S[m], 64, 0, unsigned, round_fpscr, TRUE);
        else
            S[d] = FixedToFP(S[m], 32, 0, unsigned, round_fpscr, TRUE);

```

Exceptions

Undefined Instruction.

Floating-point exceptions: Input Denormal, Invalid Operation, and Inexact.

A8.6.296 VCVT (between floating-point and fixed-point, Advanced SIMD)

This instruction converts each element in a vector from floating-point to fixed-point, or from fixed-point to floating-point, and places the results in a second vector.

The vector elements must be 32-bit floating-point numbers, or 32-bit integers. Signed and unsigned integers are distinct.

The floating-point to fixed-point operation uses the Round towards Zero rounding mode. The fixed-point to floating-point operation uses the Round to Nearest rounding mode.

Encoding T1 / A1 Advanced SIMD (UNDEFINED in integer-only variant)

VCVT<c>.<Td>.<Tm> <Qd>, <Qm>, #<fbits>

VCVT<c>.<Td>.<Tm> <Dd>, <Dm>, #<fbits>

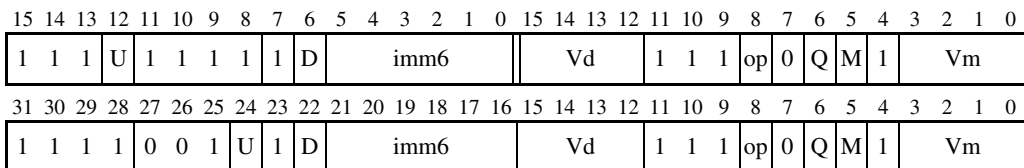

```

if imm6 == '000xxx' then SEE "Related encodings";
if imm6 == '0xxxxx' then UNDEFINED;
if Q == '1' && (Vd<0> == '1' || Vm<0> == '1') then UNDEFINED;
to_fixed = (op == '1'); unsigned = (U == '1');
if to_fixed then
    round_zero = TRUE; // Variable name indicates purpose of FPToFixed() argument
else
    round_nearest = TRUE; // Variable name indicates purpose of FixedToFP() argument
esize = 32; frac_bits = 64 - UInt(imm6);
d = UInt(D:Vd); m = UInt(M:Vm); regs = if Q == '0' then 1 else 2;
    
```

Related encodings See *One register and a modified immediate value* on page A7-21

Assembler syntax

VCVT<c><q>.<Td>.<Tm> <Qd>, <Qm>, #<fbits> Encoded as Q = 1
 VCVT<c><q>.<Td>.<Tm> <Dd>, <Dm>, #<fbits> Encoded as Q = 0

where:

<c><q> See *Standard assembler syntax fields* on page A8-7. An ARM Advanced SIMD VCVT instruction must be unconditional.

.<Td>.<Tm> The data types for the elements of the vectors. They must be one of:
 .S32.F32 encoded as op = 1, U = 0
 .U32.F32 encoded as op = 1, U = 1
 .F32.S32 encoded as op = 0, U = 0
 .F32.U32 encoded as op = 0, U = 1.

<Qd>, <Qm> The destination vector and the operand vector, for a quadword operation.

<Dd>, <Dm> The destination vector and the operand vector, for a doubleword operation.

<fbits> The number of fraction bits in the fixed point number, in the range 1 to 32:
 • (64 - <fbits>) is encoded in imm6.

An assembler can permit an <fbits> value of 0. This is encoded as floating-point to integer or integer to floating-point instruction, see *VCVT (between floating-point and integer, Advanced SIMD)* on page A8-576.

Operation

```
if ConditionPassed() then
    EncodingSpecificOperations(); CheckAdvSIMDEnabled();
    for r = 0 to regs-1
        for e = 0 to elements-1
            op = Elem[D[m+r],e,esize];
            if to_fixed then
                result = FPToFixed(op, esize, frac_bits, unsigned, round_zero, FALSE);
            else
                result = FixedToFP(op, esize, frac_bits, unsigned, round_nearest, FALSE);
            Elem[D[d+r],e,esize] = result;
```

Exceptions

Undefined Instruction.

Floating-point exceptions: Input Denormal, Invalid Operation, and Inexact.

A8.6.297 VCVT (between floating-point and fixed-point, VFP)

This instruction converts a value in a register from floating-point to fixed-point, or from fixed-point to floating-point, and places the result in a second register. You can specify the fixed-point value as either signed or unsigned.

The floating-point value can be single-precision or double-precision.

The fixed-point value can be 16-bit or 32-bit. Conversions from fixed-point values take their operand from the low-order bits of the source register and ignore any remaining bits. Signed conversions to fixed-point values sign-extend the result value to the destination register width. Unsigned conversions to fixed-point values zero-extend the result value to the destination register width.

The floating-point to fixed-point operation uses the Round towards Zero rounding mode. The fixed-point to floating-point operation uses the Round to Nearest rounding mode.

Encoding T1 / A1 VFPv3 (sf = 1 UNDEFINED in single-precision only variants)

VCVT<c>.<Td>.F64 <Dd>, <Dd>, #<fbits>

VCVT<c>.<Td>.F32 <Sd>, <Sd>, #<fbits>

VCVT<c>.F64.<Td> <Dd>, <Dd>, #<fbits>

VCVT<c>.F32.<Td> <Sd>, <Sd>, #<fbits>

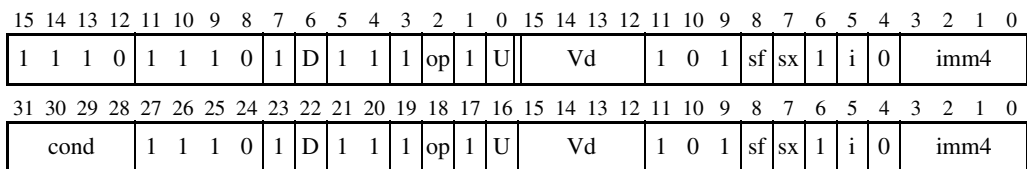

```

to_fixed = (op == '1'); dp_operation = (sf == '1'); unsigned = (U == '1');
size = if sx == '0' then 16 else 32;
frac_bits = size - UInt(imm4:i);
if to_fixed then
    round_zero = TRUE;
else
    round_nearest = TRUE;
d = if dp_operation then UInt(D:Vd) else UInt(Vd:D);
if frac_bits < 0 then UNPREDICTABLE;
    
```

Assembler syntax

VCVT<c><q>.<Td>.F64 <Dd>, <Dd>, #<fbits>	op = 1, sf = 1
VCVT<c><q>.<Td>.F32 <Sd>, <Sd>, #<fbits>	op = 1, sf = 0
VCVT<c><q>.F64.<Td> <Dd>, <Dd>, #<fbits>	op = 0, sf = 1
VCVT<c><q>.F32.<Td> <Sd>, <Sd>, #<fbits>	op = 0, sf = 0

where:

<c><q>	See <i>Standard assembler syntax fields</i> on page A8-7.								
<Td>	The data type for the fixed-point number. It must be one of: <table> <tr> <td>S16</td> <td>encoded as U = 0, sx = 0</td> </tr> <tr> <td>U16</td> <td>encoded as U = 1, sx = 0</td> </tr> <tr> <td>S32</td> <td>encoded as U = 0, sx = 1</td> </tr> <tr> <td>U32</td> <td>encoded as U = 1, sx = 1.</td> </tr> </table>	S16	encoded as U = 0, sx = 0	U16	encoded as U = 1, sx = 0	S32	encoded as U = 0, sx = 1	U32	encoded as U = 1, sx = 1.
S16	encoded as U = 0, sx = 0								
U16	encoded as U = 1, sx = 0								
S32	encoded as U = 0, sx = 1								
U32	encoded as U = 1, sx = 1.								
<Dd>	The destination and operand register, for a double-precision operand.								
<Sd>	The destination and operand register, for a single-precision operand.								
<fbits>	The number of fraction bits in the fixed-point number: <ul style="list-style-type: none"> If <Td> is S16 or U16, <fbits> must be in the range 0-16. (16 - <fbits>) is encoded in [imm4,i] If <Td> is S32 or U32, <fbits> must be in the range 1-32. (32 - <fbits>) is encoded in [imm4,i]. 								

Operation

```

if ConditionPassed() then
    EncodingSpecificOperations(); CheckVFPEnabled(TRUE);
    if to_fixed then
        if dp_operation then
            result = FPToFixed(D[d], size, frac_bits, unsigned, round_zero, TRUE);
            D[d] = if unsigned then ZeroExtend(result, 64) else SignExtend(result, 64);
        else
            result = FPToFixed(S[m], size, frac_bits, unsigned, round_zero, TRUE);
            S[d] = if unsigned then ZeroExtend(result, 32) else SignExtend(result, 32);
    else
        if dp_operation then
            D[d] = FixedToFP(D[d]<size-1:0>, 64, frac_bits, unsigned, round_nearest, TRUE);
        else
            S[d] = FixedToFP(S[d]<size-1:0>, 32, frac_bits, unsigned, round_nearest, TRUE);

```

Exceptions

Undefined Instruction.

Floating-point exceptions: Input Denormal, Invalid Operation, and Inexact.

A8.6.298 VCVT (between double-precision and single-precision)

This instruction does one of the following:

- converts the value in a double-precision register to single-precision and writes the result to a single-precision register
- converts the value in a single-precision register to double-precision and writes the result to a double-precision register.

Encoding T1 / A1 VFPv2, VFPv3 (UNDEFINED in single-precision only variants)

VCVT<c>.F64.F32 <Dd>, <Sm>

VCVT<c>.F32.F64 <Sd>, <Dm>

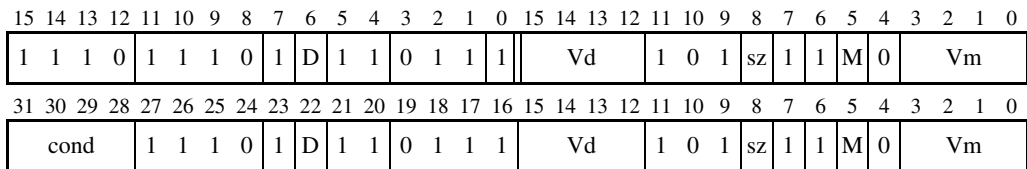

```
double_to_single = (sz == '1');
d = if double_to_single then UInt(Vd:D) else UInt(D:Vd);
m = if double_to_single then UInt(M:Vm) else UInt(Vm:M);
```

Assembler syntax

VCVT<c><q>.F64.F32 <Dd>, <Sm> Encoded as sz = 0
 VCVT<c><q>.F32.F64 <Sd>, <Dm> Encoded as sz = 1

where:

<c><q> See *Standard assembler syntax fields* on page A8-7.
 <Dd>, <Sm> The destination register and the operand register, for a single-precision operand.
 <Sd>, <Dm> The destination register and the operand register, for a double-precision operand.

Operation

```
if ConditionPassed() then
    EncodingSpecificOperations(); CheckVFPEnabled(TRUE);
    if double_to_single then
        S[d] = FPDoubleToSingle(D[m], TRUE);
    else
        D[d] = FPSingleToDouble(S[m], TRUE);
```

Exceptions

Undefined Instruction.

Floating-point exceptions: Invalid Operation, Input Denormal, Overflow, Underflow, and Inexact.

A8.6.299 VCVT (between half-precision and single-precision, Advanced SIMD)

This instruction converts each element in a vector from single-precision to half-precision floating-point or from half-precision to single-precision, and places the results in a second vector.

The vector elements must be 32-bit floating-point numbers, or 16-bit floating-point numbers.

Encoding T1 / A1 Advanced SIMD with half-precision extensions (UNDEFINED in integer-only variant)

VCVT<C>.F32.F16 <Qd>, <Dm>

VCVT<C>.F16.F32 <Dd>, <Qm>

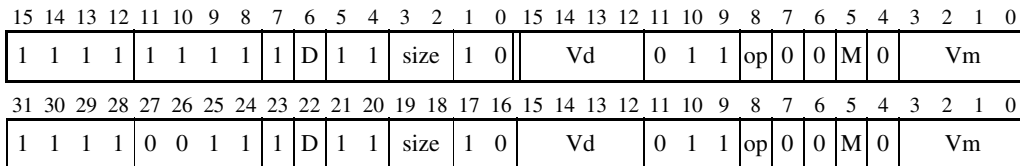

```

half_to_single = (op == '1');
if size != '01' then UNDEFINED;
if half_to_single && Vd<0> == '1' then UNDEFINED;
if !half_to_single && Vm<0> == '1' then UNDEFINED;
esize = 16; elements = 4;
m = UInt(M:Vm); d = UInt(D:Vd);
    
```

Assembler syntax

VCVT<c><q>.F32.F16 <Qd>, <Dm> Encoded as op = 1
 VCVT<c><q>.F16.F32 <Dd>, <Qm> Encoded as op = 0

where:

<c><q> See *Standard assembler syntax fields* on page A8-7.
 <Qd>, <Dm> The destination vector and the operand vector for a half-precision to single-precision operation.
 <Dd>, <Qm> The destination vector and the operand vectors for a single-precision to half-precision operation.

Operation

```
if ConditionPassed() then
    EncodingSpecificOperations(); CheckAdvSIMDEnabled();
    for e = 0 to elements-1
        if half_to_single then
            Elem[Q[d>1],e,2*esize] = FPHalfToSingle(Elem[D[m],e,esize], FALSE);
        else
            Elem[D[d],e,esize] = FPSingleToHalf(Elem[Q[m>>1],e,2*esize], FALSE);
```

Exceptions

Undefined Instruction.

Floating-point exceptions: Invalid Operation, Input Denormal, Overflow, Underflow, and Inexact.

A8.6.300 VCVTB, VCVTT (between half-precision and single-precision, VFP)

This instruction does one of the following:

- converts the half-precision value in the top or bottom half of a single-precision register to single-precision and writes the result to a single-precision register
- converts the value in a single-precision register to half-precision and writes the result into the top or bottom half of a single-precision register, preserving the other half of the target register.

Encoding T1 / A1 VFPv3 half-precision extensions

VCVT<y><c>.F32.F16 <Sd>, <Sm>

VCVT<y><c>.F16.F32 <Sd>, <Sm>

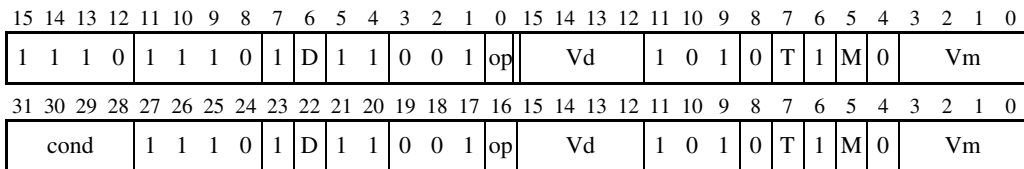

```

half_to_single = (op == '0');
lowbit = if T == '1' then 16 else 0;
m = UInt(Vm:M); d = UInt(Vd:D);
    
```

Assembler syntax

VCVT<y><c><q>.F32.F16 <Sd>, <Sm> Encoded as op = 0
 VCVT<y><c><q>.F16.F32 <Sd>, <Sm> Encoded as op = 1

where:

<y> Specifies which half of the operand register <Sm> or destination register <Sd> is used for the operand or destination. If <y> is B, then the T bit is encoded as 0 and the bottom half (bits [15:0]) of <Sm> or <Sd> is used. If <y> is T, then the T bit is encoded as 1 and the top half (bits [31:16]) of <Sm> or <Sd> is used

<c><q> See *Standard assembler syntax fields* on page A8-7.

<Sd> The destination register.

<Sm> The operand register.

Operation

```
if ConditionPassed() then
    EncodingSpecificOperations(); CheckVFPEnabled(TRUE);
    if half_to_single then
        S[d] = FPHalfToSingle(S[m]<lowbit+15:lowbit>, TRUE);
    else
        S[d]<lowbit+15:lowbit> = FPSingleToHalf(S[m], TRUE);
```

Exceptions

Undefined Instruction.

Floating-point exceptions: Invalid Operation, Input Denormal, Overflow, Underflow, and Inexact.

A8.6.301 VDIV

This instruction divides one floating-point value by another floating-point value and writes the result to a third floating-point register.

Encoding T1 / A1 VFPv2, VFPv3 (sz = 1 UNDEFINED in single-precision only variants)

VDIV<c>.F64 <Dd>, <Dn>, <Dm>

VDIV<c>.F32 <Sd>, <Sn>, <Sm>

15	14	13	12	11	10	9	8	7	6	5	4	3	2	1	0	15	14	13	12	11	10	9	8	7	6	5	4	3	2	1	0
1	1	1	0	1	1	1	0	1	D	0	0	Vn			Vd			1	0	1	sz	N	0	M	0	Vm					
31	30	29	28	27	26	25	24	23	22	21	20	19	18	17	16	15	14	13	12	11	10	9	8	7	6	5	4	3	2	1	0
cond			1	1	1	0	1	D	0	0	Vn			Vd			1	0	1	sz	N	0	M	0	Vm						

```

if FPSCR.LEN != '000' || FPSCR.STRIDE != '00' then SEE "VFP vectors";
dp_operation = (sz == '1');
d = if dp_operation then UInt(D:Vd) else UInt(Vd:D);
n = if dp_operation then UInt(N:Vn) else UInt(Vn:N);
m = if dp_operation then UInt(M:Vm) else UInt(Vm:M);

```

VFP vectors This instruction can operate on VFP vectors under control of the FPSCR.LEN and FPSCR.STRIDE bits. For details see Appendix F *VFP Vector Operation Support*.

Assembler syntax

VDIV<c><q>.F64 {<Dd>}, <Dn>, <Dm> Encoded as sz = 1
 VDIV<c><q>.F32 {<Sd>}, <Sn>, <Sm> Encoded as sz = 0

where:

<c><q> See *Standard assembler syntax fields* on page A8-7.
 <Dd>, <Dn>, <Dm> The destination register and the operand registers, for a double-precision operation.
 <Sd>, <Sn>, <Sm> The destination register and the operand registers, for a single-precision operation.

Operation

```
if ConditionPassed() then
    EncodingSpecificOperations(); CheckVFPEnabled(TRUE);
    if dp_operation then
        D[d] = FPDiv(D[n], D[m], TRUE);
    else
        S[d] = FPDiv(S[n], S[m], TRUE);
```

Exceptions

Undefined Instruction.

Floating-point exceptions: Invalid Operation, Division by Zero, Overflow, Underflow, Inexact, Input Denormal.

A8.6.302 VDUP (scalar)

Vector Duplicate duplicates a scalar into every element of the destination vector.

The scalar, and the destination vector elements, can be any one of 8-bit, 16-bit, or 32-bit bitfields. There is no distinction between data types.

For more information about scalars see *Advanced SIMD scalars* on page A7-9.

Encoding T1 / A1 Advanced SIMD

VDUP<C>.<size> <Qd>, <Dm[x]>

VDUP<C>.<size> <Dd>, <Dm[x]>

15	14	13	12	11	10	9	8	7	6	5	4	3	2	1	0	15	14	13	12	11	10	9	8	7	6	5	4	3	2	1	0
1	1	1	1	1	1	1	1	D	1	1	imm4			Vd			1	1	0	0	0	Q	M	0	Vm						
31	30	29	28	27	26	25	24	23	22	21	20	19	18	17	16	15	14	13	12	11	10	9	8	7	6	5	4	3	2	1	0
1	1	1	1	0	0	1	1	1	D	1	1	imm4			Vd			1	1	0	0	0	Q	M	0	Vm					

```

if imm4 == 'x000' then UNDEFINED;
if Q == '1' && Vd<0> == '1' then UNDEFINED;
case imm4 of
  when 'xxx1' esize = 8; elements = 8; index = UInt(imm4<3:1>);
  when 'xx10' esize = 16; elements = 4; index = UInt(imm4<3:2>);
  when 'x100' esize = 32; elements = 2; index = UInt(imm4<3>);
d = UInt(D:Vd); regs = if U == '0' then 1 else 2;
    
```

Assembler syntax

VDUP<c><q>.<size> <Qd>, <Dm[x]> Encoded as Q = 1
 VDUP<c><q>.<size> <Dd>, <Dm[x]> Encoded as Q = 0

where:

<c><q> See *Standard assembler syntax fields* on page A8-7. An ARM VDUP instruction must be unconditional.

<size> The data size. It must be one of:
 8 Encoded as imm4<0> = '1'. imm4<3:1> encodes the index [x] of the scalar.
 16 Encoded as imm4<1:0> = '10'. imm4<3:2> encodes the index [x] of the scalar.
 32 Encoded as imm4<2:0> = '100'. imm4<3> encodes the index [x] of the scalar.

<Qd> The destination vector for a quadword operation.

<Dd> The destination vector for a doubleword operation.

<Dm[x]> The scalar. For details of how [x] is encoded, see the description of <size>.

Operation

```
if ConditionPassed() then
    EncodingSpecificOperations(); CheckAdvSIMDEnabled();
    scalar = Elem[D[m],index,esize];
    for r = 0 to regs-1
        for e = 0 to elements-1
            Elem[D[d+r],e,esize] = scalar;
```

Exceptions

Undefined Instruction.

A8.6.303 VDUP (ARM core register)

This instruction duplicates an element from an ARM core register into every element of the destination vector.

The destination vector elements can be 8-bit, 16-bit, or 32-bit bitfields. The source element is the least significant 8, 16, or 32 bits of the ARM core register. There is no distinction between data types.

Encoding T1 / A1 Advanced SIMD

VDUP<C>.<size> <Qd>, <Rt>

VDUP<C>.<size> <Dd>, <Rt>

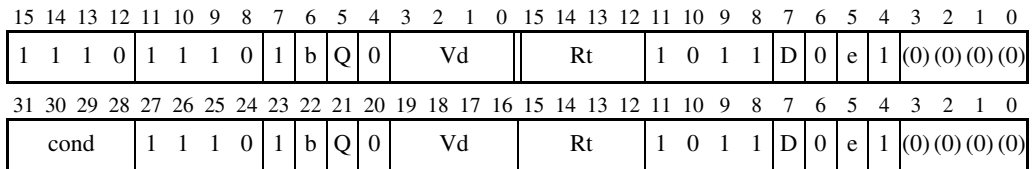

```

if Q == '1' && Vd<0> == '1' then UNDEFINED;
d = UInt(D:Vd); t = UInt(Rt); regs = if Q == '0' then 1 else 2;
case b:e of
  when '00' esize = 32; elements = 2;
  when '01' esize = 16; elements = 4;
  when '10' esize = 8; elements = 8;
  when '11' UNDEFINED;
if t == 15 || (CurrentInstrSet() != InstrSet_ARM && t == 13) then UNPREDICTABLE;
    
```

Assembler syntax

VDUP<c><q>.<size> <Qd>, <Rt> Encoded as Q = 1
 VDUP<c><q>.<size> <Dd>, <Rt> Encoded as Q = 0

where:

<c><q> See *Standard assembler syntax fields* on page A8-7. ~~An ARM VDUP instruction must be unconditional.~~

<size> The data size for the elements of the destination vector. It must be one of:
 8 encoded as [b,e] = 0b10
 16 encoded as [b,e] = 0b01
 32 encoded as [b,e] = 0b00.

<Qd> The destination vector for a quadword operation.

<Dd> The destination vector for a doubleword operation.

<Rt> The ARM source register.

Operation

```

if ConditionPassed() then
    EncodingSpecificOperations(); CheckAdvSIMDEnabled();
    scalar = R[t]<esize-1:0>;
    for r = 0 to regs-1
        for e = 0 to elements-1
            Elem[D[d+r],e,esize] = scalar;
  
```

Exceptions

Undefined Instruction.

A8.6.304 VEOR

Vector Bitwise Exclusive OR performs a bitwise Exclusive OR operation between two registers, and places the result in the destination register. The operand and result registers can be quadword or doubleword. They must all be the same size.

Encoding T1 / A1 Advanced SIMD

VEOR<c> <Qd>, <Qn>, <Qm>

VEOR<c> <Dd>, <Dn>, <Dm>

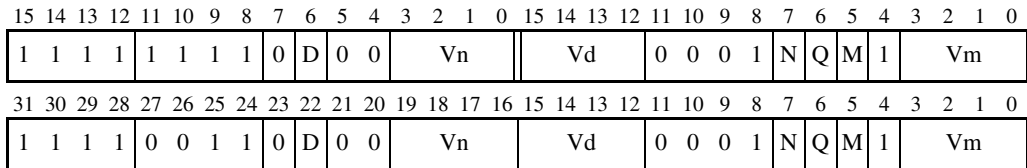

```
if Q == '1' && (Vd<0> == '1' || Vn<0> == '1' || Vm<0> == '1') then UNDEFINED;
d = UInt(D:Vd); n = UInt(N:Vn); m = UInt(M:Vm); regs = if Q == '0' then 1 else 2;
```

Assembler syntax

VEOR<c><q>{.<dt>} {<Qd>,<Qn>,<Qm>} Encoded as Q = 1
 VEORE<c><q>{.<dt>} {<Dd>,<Dn>,<Dm>} Encoded as Q = 0

where:

<c><q> See *Standard assembler syntax fields* on page A8-7. An ARM VEOR instruction must be unconditional.

<dt> An optional data type. It is ignored by assemblers, and does not affect the encoding.

<Qd>,<Qn>,<Qm> The destination vector and the operand vectors, for a quadword operation.

<Dd>,<Dn>,<Dm> The destination vector and the operand vectors, for a doubleword operation.

Operation

```
if ConditionPassed() then
    EncodingSpecificOperations(); CheckAdvSIMDEnabled();
    for r = 0 to regs-1
        D[d+r] = D[n+r] EOR D[m+r];
```

Exceptions

Undefined Instruction.

A8.6.305 VEXT

Vector Extract extracts elements from the bottom end of the second operand vector and the top end of the first, concatenates them and places the result in the destination vector. See Figure A8-1 for an example.

The elements of the vectors are treated as being 8-bit bitfields. There is no distinction between data types.

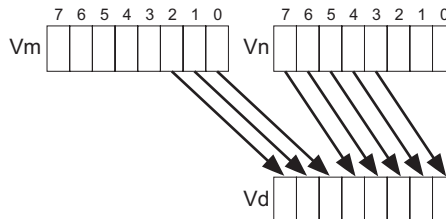
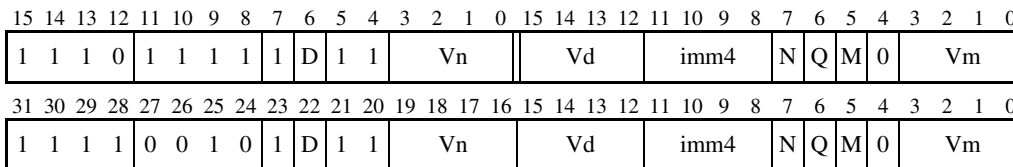

Figure A8-1 Operation of doubleword VEXT for imm = 3

Encoding T1 / A1 Advanced SIMD

VEXT<c>.8 <Qd>, <Qn>, <Qm>, #<imm>

VEXT<c>.8 <Dd>, <Dn>, <Dm>, #<imm>



```

if Q == '1' && (Vd<0> == '1' || Vn<0> == '1' || Vm<0> == '1') then UNDEFINED;
if Q == '0' && imm4<3> == '1' then UNDEFINED;
quadword_operation = (Q == '1'); position = 8 * UInt(imm4);
d = UInt(D:Vd); n = UInt(N:Vn); m = UInt(M:Vm);
    
```

Assembler syntax

VEXT<c><q>.<size> {<Qd>, } <Qn>, <Qm>, #<imm> Encoded as Q = 1
 VEXT<c><q>.<size> {<Dd>, } <Dn>, <Dm>, #<imm> Encoded as Q = 0

where:

<c><q> See *Standard assembler syntax fields* on page A8-7. An ARM VEXT instruction must be unconditional.

<size> Size of the operation. The value can be:

- 8, 16, or 32 for doubleword operations
- 8, 16, 32, or 64 for quadword operations.

If the value is 16, 32, or 64, the syntax is a pseudo-instruction for a VEXT instruction specifying the equivalent number of bytes. The following examples show how an assembler treats values greater than 8:

VEXT.16 D0,D1,#x is treated as VEXT.8 D0,D1,#(x*2)
 VEXT.32 D0,D1,#x is treated as VEXT.8 D0,D1,#(x*4)
 VEXT.64 Q0,Q1,#x is treated as VEXT.8 Q0,Q1,#(x*8).

<Qd>, <Qn>, <Qm> The destination vector and the operand vectors, for a quadword operation.

<Dd>, <Dn>, <Dm> The destination vector and the operand vectors, for a doubleword operation.

<imm> The location of the extracted result in the concatenation of the operands, as a number of bytes from the least significant end, in the range 0-7 for a doubleword operation or 0-15 for a quadword operation.

Operation

```
if ConditionPassed() then
    EncodingSpecificOperations(); CheckAdvSIMDEnabled();
    if quadword_operation then
        Q[d] = (Q[m]:Q[n])<position+127:position>;
    else
        D[d] = (D[m]:D[n])<position+63:position>;
```

Exceptions

Undefined Instruction.

A8.6.306 VHADD, VHSUB

Vector Halving Add adds corresponding elements in two vectors of integers, shifts each result right one bit, and places the final results in the destination vector. The results of the halving operations are truncated (for rounded results see *VRHADD* on page A8-734).

Vector Halving Subtract subtracts the elements of the second operand from the corresponding elements of the first operand, shifts each result right one bit, and places the final results in the destination vector. The results of the halving operations are truncated (there is no rounding version).

The operand and result elements are all the same type, and can be any one of:

- 8-bit, 16-bit, or 32-bit signed integers
- 8-bit, 16-bit, or 32-bit unsigned integers.

Encoding T1 / A1 Advanced SIMD

VH<op><c> <Qd>, <Qn>, <Qm>

VH<op><c> <Dd>, <Dn>, <Dm>

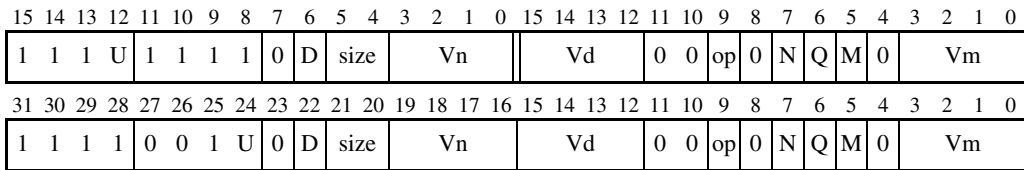

```

if Q == '1' && (Vd<0> == '1' || Vn<0> == '1' || Vm<0> == '1') then UNDEFINED;
if size == '11' then UNDEFINED;
add = (op == '0'); unsigned = (U == '1');
esize = 8 << UInt(size); elements = 64 DIV esize;
d = UInt(D:Vd); n = UInt(N:Vn); m = UInt(M:Vm); regs = if Q == '0' then 1 else 2;
    
```

Assembler syntax

VH<op><c><q>.<dt> {<Qd> ,} <Qn>, <Qm> Encoded as Q = 1

VH<op><c><q>.<dt> {<Dd> ,} <Dn>, <Dm> Encoded as Q = 0

where:

<op>	Must be one of: ADD encoded as op = 0 SUB encoded as op = 1.
<c><q>	See <i>Standard assembler syntax fields</i> on page A8-7. An ARM VHADD or VHSUB instruction must be unconditional.
<dt>	The data type for the elements of the vectors. It must be one of: S8 encoded as size = 0b00, U = 0 S16 encoded as size = 0b01, U = 0 S32 encoded as size = 0b10, U = 0 U8 encoded as size = 0b00, U = 1 U16 encoded as size = 0b01, U = 1 U32 encoded as size = 0b10, U = 1.
<Qd>, <Qn>, <Qm>	The destination vector and the operand vectors, for a quadword operation.
<Dd>, <Dn>, <Dm>	The destination vector and the operand vectors, for a doubleword operation.

Operation

```

if ConditionPassed() then
    EncodingSpecificOperations(); CheckAdvSIMDEnabled();
    for r = 0 to regs-1
        for e = 0 to elements-1
            op1 = Int(Elem[D[n+r],e,esize], unsigned);
            op2 = Int(Elem[D[m+r],e,esize], unsigned);
            result = if add then op1+op2 else op1-op2;
            Elem[D[d+r],e,esize] = result<esize:1>;

```

Exceptions

Undefined Instruction.

A8.6.307 VLD1 (multiple single elements)

This instruction loads elements from memory into one, two, three, or four registers, without de-interleaving. Every element of each register is loaded. For details of the addressing mode see *Advanced SIMD addressing mode* on page A7-30.

Encoding T1 / A1 Advanced SIMD

VLD1<c>.<size> <list>, [<Rn>{@<align>}]{!}

VLD1<c>.<size> <list>, [<Rn>{@<align>}], <Rm>

15	14	13	12	11	10	9	8	7	6	5	4	3	2	1	0	15	14	13	12	11	10	9	8	7	6	5	4	3	2	1	0
1	1	1	1	1	0	0	0	1	0	D	1	0	Rn				Vd				type				size		align		Rm		
31	30	29	28	27	26	25	24	23	22	21	20	19	18	17	16	15	14	13	12	11	10	9	8	7	6	5	4	3	2	1	0
1	1	1	1	1	0	1	0	0	0	D	1	0	Rn				Vd				type				size		align		Rm		

```

case type of
  when '0111'
    regs = 1; if align<1> == '1' then UNDEFINED;
  when '1010'
    regs = 2; if align == '11' then UNDEFINED;
  when '0110'
    regs = 3; if align<1> == '1' then UNDEFINED;
  when '0010'
    regs = 4;
  otherwise
    SEE "Related encodings";
alignment = if align == '00' then 1 else 4 << UInt(align);
ebytes = 1 << UInt(size); esize = 8 * ebytes; elements = 8 DIV ebytes;
d = UInt(D:Vd); n = UInt(Rn); m = UInt(Rm);
wback = (m != 15); register_index = (m != 15 && m != 13);
if d+regs > 32 then UNPREDICTABLE;

```

Related encodings See *Advanced SIMD element or structure load/store instructions* on page A7-27

Assembler syntax

VLD1<c><q>.<size> <list>,<Rn>{@<align>}] Rm = '1111'
VLD1<c><q>.<size> <list>, [<Rn>{@<align>}]! Rm = '1101'
VLD1<c><q>.<size> <list>, [<Rn>{@<align>}], <Rm> Rm = other values

where:

<c><q> See *Standard assembler syntax fields* on page A8-7. An ARM VLD1 instruction must be unconditional.

<size> The data size. It must be one of:
8 encoded as size = 0b00
16 encoded as size = 0b01

32	encoded as size = 0b10
64	encoded as size = 0b11.
<list>	The list of registers to load. It must be one of: {<Dd>} encoded as D:Vd = <Dd>, type = 0b0111 {<Dd>, <Dd+1>} encoded as D:Vd = <Dd>, type = 0b1010 {<Dd>, <Dd+1>, <Dd+2>} encoded as D:Vd = <Dd>, type = 0b0110 {<Dd>, <Dd+1>, <Dd+2>, <Dd+3>} encoded as D:Vd = <Dd>, type = 0b0010.
<Rn>	Contains the base address for the access.
<align>	The alignment. It can be one of: 64 8-byte alignment, encoded as align = 0b01. 128 16-byte alignment, available only if <list> contains two or four registers, encoded as align = 0b10. 256 32-byte alignment, available only if <list> contains four registers, encoded as align = 0b11. omitted Standard alignment, see <i>Unaligned data access</i> on page A3-5. Encoded as align = 0b00.
!	If present, specifies writeback.
<Rm>	Contains an address offset applied after the access.

For more information about <Rn>, !, and <Rm>, see *Advanced SIMD addressing mode* on page A7-30.

Operation

```

if ConditionPassed() then
    EncodingSpecificOperations(); CheckAdvSIMDEnabled(); NullCheckIfThumbEE(n);
    address = R[n]; if (address MOD alignment) != 0 then GenerateAlignmentException();
    if wback then R[n] = R[n] + (if register_index then R[m] else 8*regs);
    for r = 0 to regs-1
        for e = 0 to elements-1
            Elem[D[d+r],e,esize] = MemU[address,ebytes];
            address = address + ebytes;

```

Exceptions

Undefined Instruction, Data Abort.

A8.6.308 VLD1 (single element to one lane)

This instruction loads one element from memory into one element of a register. Elements of the register that are not loaded are unchanged. For details of the addressing mode see *Advanced SIMD addressing mode* on page A7-30.

Encoding T1 / A1 Advanced SIMD

VLD1<c>.<size> <list>, [<Rn>{@<align>}]{!}

VLD1<c>.<size> <list>, [<Rn>{@<align>}], <Rm>

15	14	13	12	11	10	9	8	7	6	5	4	3	2	1	0	15	14	13	12	11	10	9	8	7	6	5	4	3	2	1	0
1	1	1	1	1	0	0	1	1	D	1	0	Rn				Vd				size	0	0	index_align				Rm				
31	30	29	28	27	26	25	24	23	22	21	20	19	18	17	16	15	14	13	12	11	10	9	8	7	6	5	4	3	2	1	0
1	1	1	1	0	1	0	0	1	D	1	0	Rn				Vd				size	0	0	index_align				Rm				

if size == '11' then SEE VLD1 (single element to all lanes);

case size of

 when '00'

 if index_align<0> != '0' then UNDEFINED;

 ebytes = 1; esize = 8; index = UInt(index_align<3:1>); alignment = 1;

 when '01'

 if index_align<1> != '0' then UNDEFINED;

 ebytes = 2; esize = 16; index = UInt(index_align<3:2>);

 alignment = if index_align<0> == '0' then 1 else 2;

 when '10'

 if index_align<2> != '0' then UNDEFINED;

 if index_align<1:0> != '00' && index_align<1:0> != '11' then UNDEFINED;

 ebytes = 4; esize = 32; index = UInt(index_align<3>);

 alignment = if index_align<1:0> == '00' then 1 else 4;

d = UInt(D:Vd); n = UInt(Rn); m = UInt(Rm);

wback = (m != 15); register_index = (m != 15 && m != 13);

Assembler syntax

VLD1<c><q>.<size> <list>, [<Rn>{@<align>}]

Rm = '1111'

VLD1<c><q>.<size> <list>, [<Rn>{@<align>}]!

Rm = '1101'

VLD1<c><q>.<size> <list>, [<Rn>{@<align>}], <Rm>

Rm = other values

where:

<c><q> See *Standard assembler syntax fields* on page A8-7. An ARM VLD1 instruction must be unconditional.

<size> The data size. It must be one of:

8 encoded as size = 0b00

16 encoded as size = 0b01

32 encoded as size = 0b10.

<list>	The register containing the element to load. It must be {<Dd[x]>}. The register <Dd> is encoded in D:Vd.
<Rn>	Contains the base address for the access.
<align>	The alignment. It can be one of: 16 2-byte alignment, available only if <size> is 16 32 4-byte alignment, available only if <size> is 32 omitted Standard alignment, see <i>Unaligned data access</i> on page A3-5.
!	If present, specifies writeback.
<Rm>	Contains an address offset applied after the access.

For more information about <Rn>, !, and <Rm>, see *Advanced SIMD addressing mode* on page A7-30.

Table A8-5 shows the encoding of index and alignment for the different <size> values.

Table A8-5 Encoding of index and alignment

	<size> == 8	<size> == 16	<size> == 32
Index	index_align[3:1] = x	index_align[3:2] = x	index_align[3] = x
<align> omitted	index_align[0] = 0	index_align[1:0] = '00'	index_align[2:0] = '000'
<align> == 16	-	index_align[1:0] = '01'	-
<align> == 32	-	-	index_align[2:0] = '011'

Operation

```

if ConditionPassed() then
    EncodingSpecificOperations(); CheckAdvSIMDEnabled(); NullCheckIfThumbEE(n);
    address = R[n]; if (address MOD alignment) != 0 then GenerateAlignmentException();
    if wback then R[n] = R[n] + (if register_index then R[m] else ebytes);
    Elem[D[d],index,esize] = MemU[address,ebytes];

```

Exceptions

Undefined Instruction, Data Abort.

A8.6.309 VLD1 (single element to all lanes)

This instruction loads one element from memory into every element of one or two vectors. For details of the addressing mode see *Advanced SIMD addressing mode* on page A7-30.

Encoding T1 / A1 Advanced SIMD

VLD1<c>.<size> <list>, [<Rn>{@<align>}]{!}

VLD1<c>.<size> <list>, [<Rn>{@<align>}], <Rm>

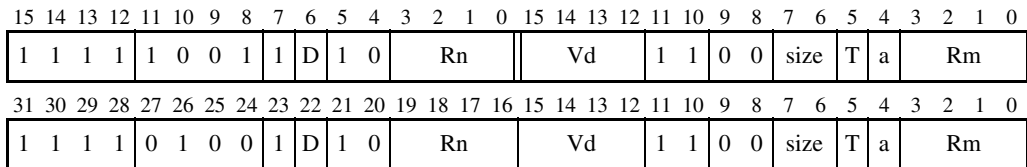

```

if size == '11' || (size == '00' && a == '1') then UNDEFINED;
ebytes = 1 << UInt(size); elements = 8 DIV ebytes; regs = if T == '0' then 1 else 2;
alignment = if a == '0' then 1 else ebytes;
d = UInt(D:Vd); n = UInt(Rn); m = UInt(Rm);
wback = (m != 15); register_index = (m != 15 && m != 13);
if d+regs > 32 then UNPREDICTABLE;

```

Assembler syntax

VLD1<c><q>.<size> <list>, [<Rn>{@<align>}]	Rm = '1111'
VLD1<c><q>.<size> <list>, [<Rn>{@<align>}]!	Rm = '1101'
VLD1<c><q>.<size> <list>, [<Rn>{@<align>}], <Rm>	Rm = other values

where:

<c><q>	See <i>Standard assembler syntax fields</i> on page A8-7. An ARM VLD1 instruction must be unconditional.
<size>	The data size. It must be one of: 8 encoded as size = 0b00 16 encoded as size = 0b01 32 encoded as size = 0b10.
<list>	The list of registers to load. It must be one of: {<Dd[]>} encoded as D:Vd = <Dd>, T = 0 {<Dd[]>, <Dd+1[]>} encoded as D:Vd = <Dd>, T = 1.
<Rn>	Contains the base address for the access.
<align>	The alignment. It can be one of: 16 2-byte alignment, available only if <size> is 16, encoded as a = 1. 32 4-byte alignment, available only if <size> is 32, encoded as a = 1. omitted Standard alignment, see <i>Unaligned data access</i> on page A3-5. Encoded as a = 0.
!	If present, specifies writeback.
<Rm>	Contains an address offset applied after the access.

For more information about <Rn>, !, and <Rm>, see *Advanced SIMD addressing mode* on page A7-30.

Operation

```

if ConditionPassed() then
    EncodingSpecificOperations(); CheckAdvSIMDEnabled(); NullCheckIfThumbEE(n);
    address = R[n]; if (address MOD alignment) != 0 then GenerateAlignmentException();
    if wback then R[n] = R[n] + (if register_index then R[m] else ebytes);
    replicated_element = Replicate(MemU[address,ebytes], elements);
    for r = 0 to regs-1
        D[d+r] = replicated_element;
  
```

Exceptions

Undefined Instruction, Data Abort.

A8.6.310 VLD2 (multiple 2-element structures)

This instruction loads multiple 2-element structures from memory into two or four registers, with de-interleaving. For more information, see *Element and structure load/store instructions* on page A4-27. Every element of each register is loaded. For details of the addressing mode see *Advanced SIMD addressing mode* on page A7-30.

Encoding T1 / A1 Advanced SIMD

VLD2<c>.<size> <list>, [<Rn>{@<align>}]{!}

VLD2<c>.<size> <list>, [<Rn>{@<align>}], <Rm>

15	14	13	12	11	10	9	8	7	6	5	4	3	2	1	0	15	14	13	12	11	10	9	8	7	6	5	4	3	2	1	0	
1	1	1	1	1	0	0	1	0	D	1	0	Rn				Vd				type				size		align		Rm				
31	30	29	28	27	26	25	24	23	22	21	20	19	18	17	16	15	14	13	12	11	10	9	8	7	6	5	4	3	2	1	0	
1	1	1	1	1	0	1	0	0	0	D	1	0	Rn				Vd				type				size		align		Rm			

```

if size == '11' then UNDEFINED;
case type of
  when '1000'
    regs = 1; inc = 1; if align == '11' then UNDEFINED;
  when '1001'
    regs = 1; inc = 2; if align == '11' then UNDEFINED;
  when '0011'
    regs = 2; inc = 2;
  otherwise
    SEE "Related encodings";
alignment = if align == '00' then 1 else 4 << UInt(align);
ebytes = 1 << UInt(size); esize = 8 * ebytes; elements = 8 DIV ebytes;
d = UInt(D:Vd); d2 = d + inc; n = UInt(Rn); m = UInt(Rm);
wback = (m != 15); register_index = (m != 15 && m != 13);
if d2+regs > 32 then UNPREDICTABLE;
    
```

Related encodings See *Advanced SIMD element or structure load/store instructions* on page A7-27

Assembler syntax

VLD2<c><q>.<size> <list>, [<Rn>{@<align>}] Rm = '1111'
VLD2<c><q>.<size> <list>, [<Rn>{@<align>}]! Rm = '1101'
VLD2<c><q>.<size> <list>, [<Rn>{@<align>}], <Rm> Rm = other values

where:

- <c><q> See *Standard assembler syntax fields* on page A8-7. An ARM VLD2 instruction must be unconditional.
- <size> The data size. It must be one of:
 - 8 encoded as size = 0b00
 - 16 encoded as size = 0b01

	32	encoded as size = 0b10.
<list>	The list of registers to load. It must be one of:	
	{<Dd>, <Dd+1>}	encoded as D:Vd = <Dd>, type = 0b1000
	{<Dd>, <Dd+2>}	encoded as D:Vd = <Dd>, type = 0b1001
	{<Dd>, <Dd+1>, <Dd+2>, <Dd+3>}	encoded as D:Vd = <Dd>, type = 0b0011.
<Rn>	Contains the base address for the access.	
<align>	The alignment. It can be one of:	
	64	8-byte alignment, encoded as align = 0b01.
	128	16-byte alignment, encoded as align = 0b10.
	256	32-byte alignment, available only if <list> contains four registers. Encoded as align = 0b11
	omitted	Standard alignment, see <i>Unaligned data access</i> on page A3-5. Encoded as align = 0b00.
!	If present, specifies writeback.	
<Rm>	Contains an address offset applied after the access.	

For more information about <Rn>, !, and <Rm>, see *Advanced SIMD addressing mode* on page A7-30.

Operation

```

if ConditionPassed() then
    EncodingSpecificOperations(); CheckAdvSIMDEnabled(); NullCheckIfThumbEE(n);
    address = R[n]; if (address MOD alignment) != 0 then GenerateAlignmentException();
    if wback then R[n] = R[n] + (if register_index then R[m] else 16*regs);
    for r = 0 to regs-1
        for e = 0 to elements-1
            Elem[D[d+r],e,esize] = MemU[address,ebytes];
            Elem[D[d2+r],e,esize] = MemU[address+ebytes,ebytes];
            address = address + 2*ebytes;

```

Exceptions

Undefined Instruction, Data Abort.

A8.6.311 VLD2 (single 2-element structure to one lane)

This instruction loads one 2-element structure from memory into corresponding elements of two registers. Elements of the registers that are not loaded are unchanged. For details of the addressing mode see *Advanced SIMD addressing mode* on page A7-30.

Encoding T1 / A1 Advanced SIMD

VLD2<c>.<size> <list>, [<Rn>{@<align>}]{!}

VLD2<c>.<size> <list>, [<Rn>{@<align>}], <Rm>

15	14	13	12	11	10	9	8	7	6	5	4	3	2	1	0	15	14	13	12	11	10	9	8	7	6	5	4	3	2	1	0
1	1	1	1	1	0	0	1	1	D	1	0	Rn				Vd		size		0	1	index_align				Rm					
31	30	29	28	27	26	25	24	23	22	21	20	19	18	17	16	15	14	13	12	11	10	9	8	7	6	5	4	3	2	1	0
1	1	1	1	0	1	0	0	1	D	1	0	Rn				Vd		size		0	1	index_align				Rm					

if size == '11' then SEE VLD2 (single 2-element structure to all lanes);

case size of

when '00'

ebytes = 1; esize = 8; index = UInt(index_align<3:1>); inc = 1;

alignment = if index_align<0> == '0' then 1 else 2;

when '01'

ebytes = 2; esize = 16; index = UInt(index_align<3:2>);

inc = if index_align<1> == '0' then 1 else 2;

alignment = if index_align<0> == '0' then 1 else 4;

when '10'

if index_align<1> != '0' then UNDEFINED;

ebytes = 4; esize = 32; index = UInt(index_align<3>);

inc = if index_align<2> == '0' then 1 else 2;

alignment = if index_align<0> == '0' then 1 else 8;

d = UInt(D:Vd); d2 = d + inc; n = UInt(Rn); m = UInt(Rm);

wback = (m != 15); register_index = (m != 15 && m != 13);

if d2 > 31 then UNPREDICTABLE; [j](#)

Assembler syntax

VLD2<c><q>.<size> <list>, [<Rn>{@<align>}] Rm = '1111'

VLD2<c><q>.<size> <list>, [<Rn>{@<align>}]! Rm = '1101'

VLD2<c><q>.<size> <list>, [<Rn>{@<align>}], <Rm> Rm = other values

where:

<c><q> See *Standard assembler syntax fields* on page A8-7. An ARM VLD2 instruction must be unconditional.

<size> The data size. It must be one of:

8 encoded as size = 0b00

16 encoded as size = 0b01

32 encoded as size = 0b10.

- <list> The registers containing the structure. Encoded with $D:Vd = \langle Dd \rangle$. It must be one of:
 { $\langle Dd[x] \rangle$, $\langle Dd+1[x] \rangle$ } Single-spaced registers, see Table A8-6.
 { $\langle Dd[x] \rangle$, $\langle Dd+2[x] \rangle$ } Double-spaced registers, see Table A8-6.
 This is not available if $\langle size \rangle == 8$.
- <Rn> Contains the base address for the access.
- <align> The alignment. It can be one of:
 16 2-byte alignment, available only if $\langle size \rangle$ is 8
 32 4-byte alignment, available only if $\langle size \rangle$ is 16
 64 8-byte alignment, available only if $\langle size \rangle$ is 32
omitted Standard alignment, see *Unaligned data access* on page A3-5.
- ! If present, specifies writeback.
- <Rm> Contains an address offset applied after the access.

For more information about <Rn>, !, and <Rm> see *Advanced SIMD addressing mode* on page A7-30.

Table A8-6 Encoding of index, alignment, and register spacing

	$\langle size \rangle == 8$	$\langle size \rangle == 16$	$\langle size \rangle == 32$
Index	$index_align[3:1] = x$	$index_align[3:2] = x$	$index_align[3] = x$
Single-spacing	-	$index_align[1] = 0$	$index_align[2] = 0$
Double-spacing	-	$index_align[1] = 1$	$index_align[2] = 1$
<align> omitted	$index_align[0] = 0$	$index_align[0] = 0$	$index_align[1:0] = '00'$
<align> == 16	$index_align[0] = 1$	-	-
<align> == 32	-	$index_align[0] = 1$	-
<align> == 64	-	-	$index_align[1:0] = '01'$

Operation

```

if ConditionPassed() then
    EncodingSpecificOperations(); CheckAdvSIMDEnabled(); NullCheckIfThumbEE(n);
    address = R[n]; if (address MOD alignment) != 0 then GenerateAlignmentException();
    if wback then R[n] = R[n] + (if register_index then R[m] else 2*ebytes);
    Elem[D[d],index,esize] = MemU[address,ebytes];
    Elem[D[d2],index,esize] = MemU[address+ebytes,ebytes];

```

Exceptions

Undefined Instruction, Data Abort.

A8.6.312 VLD2 (single 2-element structure to all lanes)

This instruction loads one 2-element structure from memory into all lanes of two registers. For details of the addressing mode see *Advanced SIMD addressing mode* on page A7-30.

Encoding T1 / A1 Advanced SIMD

VLD2<c>.<size> <list>, [<Rn>{@<align>}]{!}

VLD2<c>.<size> <list>, [<Rn>{@<align>}], <Rm>

15	14	13	12	11	10	9	8	7	6	5	4	3	2	1	0	15	14	13	12	11	10	9	8	7	6	5	4	3	2	1	0
1	1	1	1	1	0	0	1	1	D	1	0	Rn				Vd				1	1	0	1	size	T	a	Rm				
31	30	29	28	27	26	25	24	23	22	21	20	19	18	17	16	15	14	13	12	11	10	9	8	7	6	5	4	3	2	1	0
1	1	1	1	0	1	0	0	1	D	1	0	Rn				Vd				1	1	0	1	size	T	a	Rm				

```

if size == '11' then UNDEFINED;
ebytes = 1 << UInt(size);  elements = 8 DIV ebytes;
alignment = if a == '0' then 1 else 2*ebytes;
inc = if T == '0' then 1 else 2;
d = UInt(D:Vd);  d2 = d + inc;  n = UInt(Rn);  m = UInt(Rm);
wback = (m != 15);  register_index = (m != 15 && m != 13);
if d2 > 31 then UNPREDICTABLE;

```

Assembler syntax

VLD2<c><q>.<size> <list>, [<Rn>{@<align>}] Rm = '1111'
VLD2<c><q>.<size> <list>, [<Rn>{@<align>}]! Rm = '1101'
VLD2<c><q>.<size> <list>, [<Rn>{@<align>}], <Rm> Rm = other values

where:

<c><q> See *Standard assembler syntax fields* on page A8-7. An ARM VLD2 instruction must be unconditional.

<size> The data size. It must be one of:
8 encoded as size = 0b00
16 encoded as size = 0b01
32 encoded as size = 0b10.

<list> The registers containing the structure. It must be one of:
{<Dd>[>], <Dd+1>[>]} single-spaced register transfer, encoded as D:Vd = <Dd>, T = 0
{<Dd>[>], <Dd+2>[>]} double-spaced register transfer, encoded as D:Vd = <Dd>, T = 1.

<Rn> Contains the base address for the access.

<align> The alignment. It can be one of:
16 2-byte alignment, available only if <size> is 8, encoded as a = 1
32 4-byte alignment, available only if <size> is 16, encoded as a = 1

- 64 8-byte alignment, available only if <size> is 32, encoded as a = 1
- omitted** Standard alignment, see *Unaligned data access* on page A3-5. Encoded as a = 0.
- ! If present, specifies writeback.
- <Rm> Contains an address offset applied after the access.

For more information about <Rn>, !, and <Rm>, see *Advanced SIMD addressing mode* on page A7-30.

Operation

```

if ConditionPassed() then
    EncodingSpecificOperations(); CheckAdvSIMDEnabled(); NullCheckIfThumbEE(n);
    address = R[n]; if (address MOD alignment) != 0 then GenerateAlignmentException();
    if wback then R[n] = R[n] + (if register_index then R[m] else 2*ebytes);
    D[d] = Replicate(MemU[address,ebytes], elements);
    D[d2] = Replicate(MemU[address+ebytes,ebytes], elements);

```

Exceptions

Undefined Instruction, Data Abort.

A8.6.313 VLD3 (multiple 3-element structures)

This instruction loads multiple 3-element structures from memory into three registers, with de-interleaving. For more information, see *Element and structure load/store instructions* on page A4-27. Every element of each register is loaded. For details of the addressing mode see *Advanced SIMD addressing mode* on page A7-30.

Encoding T1 / A1 Advanced SIMD

VLD3<c>.<size> <list>, [<Rn>{@<align>}]{!}

VLD3<c>.<size> <list>, [<Rn>{@<align>}], <Rm>

15	14	13	12	11	10	9	8	7	6	5	4	3	2	1	0	15	14	13	12	11	10	9	8	7	6	5	4	3	2	1	0					
1	1	1	1	1	0	0	1	0	D	1	0					Rn															Vd	type	size	align	Rm	
31	30	29	28	27	26	25	24	23	22	21	20	19	18	17	16	15	14	13	12	11	10	9	8	7	6	5	4	3	2	1	0					
1	1	1	1	1	0	1	0	0	0	D	1	0				Rn																Vd	type	size	align	Rm

```

if size == '11' || align<1> == '1' then UNDEFINED;
case type of
  when '0100'
    inc = 1;
  when '0101'
    inc = 2;
  otherwise
    SEE "Related encodings";
alignment = if align<0> == '0' then 1 else 8;
ebytes = 1 << UInt(size);  esize = 8 * ebytes;  elements = 8 DIV ebytes;
d = UInt(D:Vd);  d2 = d + inc;  d3 = d2 + inc;  n = UInt(Rn);  m = UInt(Rm);
wback = (m != 15);  register_index = (m != 15 && m != 13);
if d3 > 31 then UNPREDICTABLE;

```

Related encodings See *Advanced SIMD element or structure load/store instructions* on page A7-27

Assembler syntax

VLD3<c><q>.<size> <list>, [<Rn>{@<align>}] Rm = '1111'

VLD3<c><q>.<size> <list>, [<Rn>{@<align>}]! Rm = '1101'

VLD3<c><q>.<size> <list>, [<Rn>{@<align>}], <Rm> Rm = other values

where:

<c><q> See *Standard assembler syntax fields* on page A8-7. An ARM VLD3 instruction must be unconditional.

<size> The data size. It must be one of:

8	encoded as size = 0b00
16	encoded as size = 0b01
32	encoded as size = 0b10.

- <list> The list of registers to load. It must be one of:
 {<Dd>, <Dd+1>, <Dd+2>}
 encoded as D:Vd = <Dd>, type = 0b0100
 {<Dd>, <Dd+2>, <Dd+4>}
 encoded as D:Vd = <Dd>, type = 0b0101.
- <Rn> Contains the base address for the access.
- <align> The alignment. It can be:
 64 8-byte alignment, encoded as align = 0b01.
omitted Standard alignment, see *Unaligned data access* on page A3-5. Encoded as
 align = 0b00.
- ! If present, specifies writeback.
- <Rm> Contains an address offset applied after the access.

For more information about <Rn>, !, and <Rm>, see *Advanced SIMD addressing mode* on page A7-30.

Operation

```

if ConditionPassed() then
    EncodingSpecificOperations(); CheckAdvSIMDEnabled(); NullCheckIfThumbEE(n);
    address = R[n]; if (address MOD alignment) != 0 then GenerateAlignmentException();
    if wback then R[n] = R[n] + (if register_index then R[m] else 24);
    for e = 0 to elements-1
        Elem[D[d],e,esize] = MemU[address,ebytes];
        Elem[D[d2],e,esize] = MemU[address+ebytes,ebytes];
        Elem[D[d3],e,esize] = MemU[address+2*ebytes,ebytes];
        address = address + 3*ebytes;

```

Exceptions

Undefined Instruction, Data Abort.

A8.6.314 VLD3 (single 3-element structure to one lane)

This instruction loads one 3-element structure from memory into corresponding elements of three registers. Elements of the registers that are not loaded are unchanged. For details of the addressing mode see *Advanced SIMD addressing mode* on page A7-30.

Encoding T1 / A1 Advanced SIMD

VLD3<c>.<size> <list>, [<Rn>]{}!

VLD3<c>.<size> <list>, [<Rn>], <Rm>

15	14	13	12	11	10	9	8	7	6	5	4	3	2	1	0	15	14	13	12	11	10	9	8	7	6	5	4	3	2	1	0
1	1	1	1	1	0	0	1	1	D	1	0	Rn				Vd				size	1	0	index_align				Rm				
31	30	29	28	27	26	25	24	23	22	21	20	19	18	17	16	15	14	13	12	11	10	9	8	7	6	5	4	3	2	1	0
1	1	1	1	1	0	1	0	0	1	D	1	0	Rn				Vd				size	1	0	index_align				Rm			

if size == '11' then SEE VLD3 (single 3-element structure to all lanes);

case size of

 when '00'

 if index_align<0> != '0' then UNDEFINED;

 ebytes = 1; esize = 8; index = UInt(index_align<3:1>); inc = 1;

 when '01'

 if index_align<0> != '0' then UNDEFINED;

 ebytes = 2; esize = 16; index = UInt(index_align<3:2>);

 inc = if index_align<1> == '0' then 1 else 2;

 when '10'

 if index_align<1:0> != '00' then UNDEFINED;

 ebytes = 4; esize = 32; index = UInt(index_align<3>);

 inc = if index_align<2> == '0' then 1 else 2;

d = UInt(D:Vd); d2 = d + inc; d3 = d2 + inc; n = UInt(Rn); m = UInt(Rm);

wback = (m != 15); register_index = (m != 15 && m != 13);

if d3 > 31 then UNPREDICTABLE; [u](#)

Assembler syntax

VLD3<c><q>.<size> <list>, [<Rn>]

Rm = '1111'

VLD3<c><q>.<size> <list>, [<Rn>!]

Rm = '1101'

VLD3<c><q>.<size> <list>, [<Rn>], <Rm>

Rm = other values

where:

<c><q> See *Standard assembler syntax fields* on page A8-7. An ARM VLD3 instruction must be unconditional.

<size> The data size. It must be one of:

8 encoded as size = 0b00

16 encoded as size = 0b01

32 encoded as size = 0b10.

- <list> The registers containing the structure. Encoded with $D:Vd = \langle Dd \rangle$. It must be one of:
 { $\langle Dd[x] \rangle$, $\langle Dd+1[x] \rangle$, $\langle Dd+2[x] \rangle$ }
 Single-spaced registers, see Table A8-7.
 { $\langle Dd[x] \rangle$, $\langle Dd+2[x] \rangle$, $\langle Dd+4[x] \rangle$ }
 Double-spaced registers, see Table A8-7. This is not available if $\langle \text{size} \rangle == 8$.
- <Rn> Contains the base address for the access.
- ! If present, specifies writeback.
- <Rm> Contains an address offset applied after the access.

For more information about <Rn>, !, and <Rm>, see *Advanced SIMD addressing mode* on page A7-30.

Table A8-7 Encoding of index and register spacing

	$\langle \text{size} \rangle == 8$	$\langle \text{size} \rangle == 16$	$\langle \text{size} \rangle == 32$
Index	$\text{index_align}[3:1] = x$	$\text{index_align}[3:2] = x$	$\text{index_align}[3] = x$
Single-spacing	$\text{index_align}[0] = 0$	$\text{index_align}[1:0] = '00'$	$\text{index_align}[2:0] = '000'$
Double-spacing	-	$\text{index_align}[1:0] = '10'$	$\text{index_align}[2:0] = '100'$

Alignment

Standard alignment rules apply, see *Unaligned data access* on page A3-5.

Operation

```

if ConditionPassed() then
    EncodingSpecificOperations(); CheckAdvSIMDEnabled(); NullCheckIfThumbEE(n);
    address = R[n];
    if wback then R[n] = R[n] + (if register_index then R[m] else 3*ebytes);
    Elem[D[d],index,esize] = MemU[address,ebytes];
    Elem[D[d2],index,esize] = MemU[address+ebytes,ebytes];
    Elem[D[d3],index,esize] = MemU[address+2*ebytes,ebytes];
  
```

Exceptions

Undefined Instruction, Data Abort.

A8.6.315 VLD3 (single 3-element structure to all lanes)

This instruction loads one 3-element structure from memory into all lanes of three registers. For details of the addressing mode see *Advanced SIMD addressing mode* on page A7-30.

Encoding T1 / A1 Advanced SIMD

VLD3<c>.<size> <list>, [<Rn>]!;

VLD3<c>.<size> <list>, [<Rn>], <Rm>

15	14	13	12	11	10	9	8	7	6	5	4	3	2	1	0	15	14	13	12	11	10	9	8	7	6	5	4	3	2	1	0
1	1	1	1	1	0	0	1	1	D	1	0	Rn				Vd				1	1	1	0	size	T	a	Rm				
31	30	29	28	27	26	25	24	23	22	21	20	19	18	17	16	15	14	13	12	11	10	9	8	7	6	5	4	3	2	1	0
1	1	1	1	0	1	0	0	1	D	1	0	Rn				Vd				1	1	1	0	size	T	a	Rm				

```

if size == '11' || a == '1' then UNDEFINED;
ebytes = 1 << UInt(size); elements = 8 DIV ebytes;
inc = if T == '0' then 1 else 2;
d = UInt(D:Vd); d2 = d + inc; d3 = d2 + inc; n = UInt(Rn); m = UInt(Rm);
wback = (m != 15); register_index = (m != 15 && m != 13);
if d3 > 31 then UNPREDICTABLE;
    
```

Assembler syntax

VLD3<c><q>.<size> <list>, [<Rn>] Rm = '1111'

VLD3<c><q>.<size> <list>, [<Rn>! Rm = '1101'

VLD3<c><q>.<size> <list>, [<Rn>], <Rm> Rm = other values

where:

- <c><q> See *Standard assembler syntax fields* on page A8-7. An ARM VLD3 instruction must be unconditional.
- <size> The data size. It must be one of:
 - 8 encoded as size = 0b00
 - 16 encoded as size = 0b01
 - 32 encoded as size = 0b10.
- <list> The registers containing the structures. It must be one of:
 - {<Dd[]>, <Dd+1[]>, <Dd+2[]>}
Single-spaced register transfer, encoded as D:Vd = <Dd>, T = 0.
 - {<Dd[]>, <Dd+2[]>, <Dd+4[]>}
Double-spaced register transfer, encoded as D:Vd = <Dd>, T = 1.
- <Rn> Contains the base address for the access.
- ! If present, specifies writeback.

<Rm> Contains an address offset applied after the access.

For more information about <Rn>, !, and <Rm>, see *Advanced SIMD addressing mode* on page A7-30.

Alignment

Standard alignment rules apply, see *Unaligned data access* on page A3-5.

The a bit must be encoded as 0.

Operation

```

if ConditionPassed() then
    EncodingSpecificOperations(); CheckAdvSIMDEnabled(); NullCheckIfThumbEE(n);
    address = R[n];
    if wback then R[n] = R[n] + (if register_index then R[m] else 3*ebytes);
    D[d] = Replicate(MemU[address,ebytes], elements);
    D[d2] = Replicate(MemU[address+ebytes,ebytes], elements);
    D[d3] = Replicate(MemU[address+2*ebytes,ebytes], elements);

```

Exceptions

Undefined Instruction, Data Abort.

A8.6.316 VLD4 (multiple 4-element structures)

This instruction loads multiple 4-element structures from memory into four registers, with de-interleaving. For more information, see *Element and structure load/store instructions* on page A4-27. Every element of each register is loaded. For details of the addressing mode see *Advanced SIMD addressing mode* on page A7-30.

Encoding T1 / A1 Advanced SIMD

VLD4<c>.<size> <list>, [<Rn>{@<align>}]{!}

VLD4<c>.<size> <list>, [<Rn>{@<align>}], <Rm>

15	14	13	12	11	10	9	8	7	6	5	4	3	2	1	0	15	14	13	12	11	10	9	8	7	6	5	4	3	2	1	0				
1	1	1	1	1	0	0	1	0	D	1	0					Rn														Vd	type	size	align	Rm	
31	30	29	28	27	26	25	24	23	22	21	20	19	18	17	16	15	14	13	12	11	10	9	8	7	6	5	4	3	2	1	0				
1	1	1	1	1	0	1	0	0	0	D	1	0				Rn															Vd	type	size	align	Rm

if size == '11' then UNDEFINED;

case type of

 when '0000'

 inc = 1;

 when '0001'

 inc = 2;

 otherwise

 SEE "Related encodings";

alignment = if align == '00' then 1 else 4 << UInt(align);

ebytes = 1 << UInt(size); esize = 8 * ebytes; elements = 8 DIV ebytes;

d = UInt(D:Vd); d2 = d + inc; d3 = d2 + inc; d4 = d3 + inc; n = UInt(Rn); m = UInt(Rm);

wback = (m != 15); register_index = (m != 15 && m != 13);

if d4 > 31 then UNPREDICTABLE;

Related encodings See *Advanced SIMD element or structure load/store instructions* on page A7-27

Assembler syntax

VLD4<c><q>.<size> <list>, [<Rn>{@<align>}]

Rm = '1111'

VLD4<c><q>.<size> <list>, [<Rn>{@<align>}]!

Rm = '1101'

VLD4<c><q>.<size> <list>, [<Rn>{@<align>}], <Rm>

Rm = other values

where:

<c><q> See *Standard assembler syntax fields* on page A8-7. An ARM VLD4 instruction must be unconditional.

<size> The data size. It must be one of:

8 encoded as size = 0b00

16 encoded as size = 0b01

32 encoded as size = 0b10.

<list>	The list of registers to load. It must be one of: {<Dd>, <Dd+1>, <Dd+2>, <Dd+3>} encoded as D:Vd = <Dd>, type = 0b0000 {<Dd>, <Dd+2>, <Dd+4>, <Dd+6>} encoded as D:Vd = <Dd>, type = 0b0001.
<Rn>	Contains the base address for the access.
<align>	The alignment. It can be one of: 64 8-byte alignment, encoded as align = 0b01. 128 16-byte alignment, encoded as align = 0b10. 256 32-byte alignment, encoded as align = 0b11. omitted Standard alignment, see <i>Unaligned data access</i> on page A3-5. Encoded as align = 0b00.
!	If present, specifies writeback.
<Rm>	Contains an address offset applied after the access.

For more information about <Rn>, !, and <Rm>, see *Advanced SIMD addressing mode* on page A7-30.

Operation

```

if ConditionPassed() then
    EncodingSpecificOperations(); CheckAdvSIMDEnabled(); NullCheckIfThumbEE(n);
    address = R[n]; if (address MOD alignment) != 0 then GenerateAlignmentException();
    if wback then R[n] = R[n] + (if register_index then R[m] else 32);
    for e = 0 to elements-1
        Elem[D[d],e,esize] = MemU[address,ebytes];
        Elem[D[d2],e,esize] = MemU[address+ebytes,ebytes];
        Elem[D[d3],e,esize] = MemU[address+2*ebytes,ebytes];
        Elem[D[d4],e,esize] = MemU[address+3*ebytes,ebytes];
        address = address + 4*ebytes;

```

Exceptions

Undefined Instruction, Data Abort.

A8.6.317 VLD4 (single 4-element structure to one lane)

This instruction loads one 4-element structure from memory into corresponding elements of four registers. Elements of the registers that are not loaded are unchanged. For details of the addressing mode see *Advanced SIMD addressing mode* on page A7-30.

Encoding T1 / A1 Advanced SIMD

VLD4<c>.<size> <list>, [<Rn>{@<align>}]{!}

VLD4<c>.<size> <list>, [<Rn>{@<align>}], <Rm>

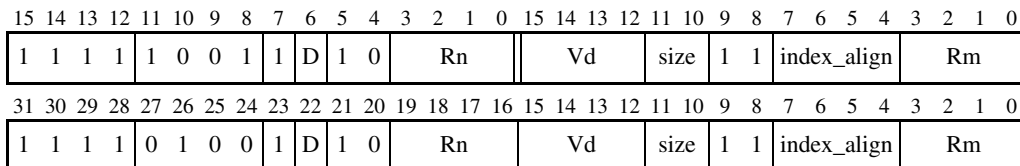

if size == '11' then SEE VLD4 (single 4-element structure to all lanes);

case size of

when '00'

ebytes = 1; esize = 8; index = UInt(index_align<3:1>); inc = 1;

alignment = if index_align<0> == '0' then 1 else 4;

when '01'

ebytes = 2; esize = 16; index = UInt(index_align<3:2>);

inc = if index_align<1> == '0' then 1 else 2;

alignment = if index_align<0> == '0' then 1 else 8;

when '10'

if index_align<1:0> == '11' then UNDEFINED;

ebytes = 4; esize = 32; index = UInt(index_align<3>);

inc = if index_align<2> == '0' then 1 else 2;

alignment = if index_align<1:0> == '00' then 1 else 4 << UInt(index_align<1:0>);

d = UInt(D:Vd); d2 = d + inc; d3 = d2 + inc; d4 = d3 + inc; n = UInt(Rn); m = UInt(Rm);

wback = (m != 15); register_index = (m != 15 && m != 13);

if d4 > 31 then UNPREDICTABLE;

Assembler syntax

VLD4<c><q>.<size> <list>, [<Rn>{@<align>}] Rm = '1111'

VLD4<c><q>.<size> <list>, [<Rn>{@<align>}]! Rm = '1101'

VLD4<c><q>.<size> <list>, [<Rn>{@<align>}], <Rm> Rm = other values

where:

<c><q> See *Standard assembler syntax fields* on page A8-7. An ARM VLD4 instruction must be unconditional.

<size> The data size. It must be one of:

8 encoded as size = 0b00

16 encoded as size = 0b01

32 encoded as size = 0b10

<list>	The registers containing the structure. Encoded with $D:Vd = \langle Dd \rangle$. It must be one of: { $\langle Dd[x] \rangle$, $\langle Dd+1[x] \rangle$, $\langle Dd+2[x] \rangle$, $\langle Dd+3[x] \rangle$ } single-spaced registers, see Table A8-8. { $\langle Dd[x] \rangle$, $\langle Dd+2[x] \rangle$, $\langle Dd+4[x] \rangle$, $\langle Dd+6[x] \rangle$ } double-spaced registers, see Table A8-8. Not available if $\langle \text{size} \rangle == 8$.
<Rn>	The base address for the access.
<align>	The alignment. It can be: 32 4-byte alignment, available only if $\langle \text{size} \rangle$ is 8. 64 8-byte alignment, available only if $\langle \text{size} \rangle$ is 16 or 32. 128 16-byte alignment, available only if $\langle \text{size} \rangle$ is 32. omitted Standard alignment, see <i>Unaligned data access</i> on page A3-5.
!	If present, specifies writeback.
<Rm>	Contains an address offset applied after the access.

For more information about <Rn>, !, and <Rm> see *Advanced SIMD addressing mode* on page A7-30.

Table A8-8 Encoding of index, alignment, and register spacing

	$\langle \text{size} \rangle == 8$	$\langle \text{size} \rangle == 16$	$\langle \text{size} \rangle == 32$
Index	$\text{index_align}[3:1] = x$	$\text{index_align}[3:2] = x$	$\text{index_align}[3] = x$
Single-spacing	-	$\text{index_align}[1] = 0$	$\text{index_align}[2] = 0$
Double-spacing	-	$\text{index_align}[1] = 1$	$\text{index_align}[2] = 1$
<align> omitted	$\text{index_align}[0] = 0$	$\text{index_align}[0] = 0$	$\text{index_align}[1:0] = '00'$
<align> == 32	$\text{index_align}[0] = 1$	-	-
<align> == 64	-	$\text{index_align}[0] = 1$	$\text{index_align}[1:0] = '01'$
<align> == 128	-	-	$\text{index_align}[1:0] = '10'$

Operation

```

if ConditionPassed() then
    EncodingSpecificOperations(); CheckAdvSIMDEnabled(); NullCheckIfThumbEE(n);
    address = R[n]; if (address MOD alignment) != 0 then GenerateAlignmentException();
    if wback then R[n] = R[n] + (if register_index then R[m] else 4*ebytes);
    Elem[D[d],index,esize] = MemU[address,ebytes];
    Elem[D[d2],index,esize] = MemU[address+ebytes,ebytes];
    Elem[D[d3],index,esize] = MemU[address+2*ebytes,ebytes];
    Elem[D[d4],index,esize] = MemU[address+3*ebytes,ebytes];

```

Exceptions

Undefined Instruction, Data Abort.

A8.6.318 VLD4 (single 4-element structure to all lanes)

This instruction loads one 4-element structure from memory into all lanes of four registers. For details of the addressing mode see *Advanced SIMD addressing mode* on page A7-30.

Encoding T1 / A1 Advanced SIMD

VLD4<c>.<size> <list>, [<Rn>{ @<align>}]{!}

VLD4<c>.<size> <list>, [<Rn>{ @<align>}], <Rm>

15	14	13	12	11	10	9	8	7	6	5	4	3	2	1	0	15	14	13	12	11	10	9	8	7	6	5	4	3	2	1	0
1	1	1	1	1	0	0	1	1	D	1	0	Rn				Vd				1	1	1	1	size	T	a	Rm				
31	30	29	28	27	26	25	24	23	22	21	20	19	18	17	16	15	14	13	12	11	10	9	8	7	6	5	4	3	2	1	0
1	1	1	1	0	1	0	0	1	D	1	0	Rn				Vd				1	1	1	1	size	T	a	Rm				

```

if size == '11' && a == '0' then UNDEFINED;
if size == '11' then
    ebytes = 4; elements = 2; alignment = 16;
else
    ebytes = 1 << UInt(size); elements = 8 DIV ebytes;
    if size == '10' then
        alignment = if a == '0' then 1 else 8;
    else
        alignment = if a == '0' then 1 else 4*ebytes;
inc = if T == '0' then 1 else 2;
d = UInt(D:Vd); d2 = d + inc; d3 = d2 + inc; d4 = d3 + inc; n = UInt(Rn); m = UInt(Rm);
wback = (m != 15); register_index = (m != 15 && m != 13);
if d4 > 31 then UNPREDICTABLE;

```

Assembler syntax

VLD4<c><q>.<size> <list>, [<Rn>{ @<align>}]	Rm = '1111'
VLD4<c><q>.<size> <list>, [<Rn>{ @<align>}]!	Rm = '1101'
VLD4<c><q>.<size> <list>, [<Rn>{ @<align>}], <Rm>	Rm = other values

where:

<c><q> See *Standard assembler syntax fields* on page A8-7. An ARM VLD4 instruction must be unconditional.

<size> The data size. It must be one of:

8	encoded as size = 0b00
16	encoded as size = 0b01
32	encoded as size = 0b10 (or 0b11 for 16-byte alignment).

<list> The registers containing the structures. It must be one of:

{<Dd[>], <Dd+1[>], <Dd+2[>], <Dd+3[>]}

single-spaced registers, encoded as D:Vd = <Dd>, T = 0

{<Dd[]>, <Dd+2[]>, <Dd+4[]>, <Dd+6[]>}

double-spaced register transfer, encoded as D:Vd = <Dd>, T = 1.

<Rn> The base address for the access.

<align> The alignment. It can be one of:

32 4-byte alignment, available only if <size> is 8, encoded as a = 1.

64 8-byte alignment, available only if <size> is 16 or 32, encoded as a = 1.

128 16-byte alignment, available only if <size> is 32, encoded as a = 1, size = 0b11.

omitted Standard alignment, see *Unaligned data access* on page A3-5. Encoded as a = 0.

! If present, specifies writeback.

<Rm> Contains an address offset applied after the access.

For more information about <Rn>, !, and <Rm>, see *Advanced SIMD addressing mode* on page A7-30.

Operation

```

if ConditionPassed() then
    EncodingSpecificOperations(); CheckAdvSIMDEnabled(); NullCheckIfThumbEE(n);
    address = R[n]; if (address MOD alignment) != 0 then GenerateAlignmentException();
    if wback then R[n] = R[n] + (if register_index then R[m] else 4*ebytes);
    D[d] = Replicate(MemU[address,ebytes], elements);
    D[d2] = Replicate(MemU[address+ebytes,ebytes], elements);
    D[d3] = Replicate(MemU[address+2*ebytes,ebytes], elements);
    D[d4] = Replicate(MemU[address+3*ebytes,ebytes], elements);

```

Exceptions

Undefined Instruction, Data Abort.

A8.6.319 VLDM

Vector Load Multiple loads multiple extension registers from consecutive memory locations using an address from an ARM core register.

Encoding T1 / A1 VFPv2, VFPv3, Advanced SIMD

VLDM{mode}<c> <Rn>{!}, <list> <list> is consecutive 64-bit registers

15	14	13	12	11	10	9	8	7	6	5	4	3	2	1	0	15	14	13	12	11	10	9	8	7	6	5	4	3	2	1	0																																																																																																																																																																																																																																																																																																																																																																																																																																																																																																
1	1	1	0	1	1	0	P	U	D	W	1	Rn				Vd				1	0	1	1	imm8																																																																																																																																																																																																																																																																																																																																																																																																																																																																																																							
31																30																29																28																27																26																25																24																23																22																21																20																19																18																17																16																15																14																13																12																11																10																9																8																7																6																5																4																3																2																1																0															
cond				1 1 0				P	U	D	W	1	Rn				Vd				1 0 1 1				imm8																																																																																																																																																																																																																																																																																																																																																																																																																																																																																																						

```

if P == '0' && U == '0' && W == '0' then SEE "Related encodings";
if P == '0' && U == '1' && W == '1' && Rn == '1101' then SEE VPOP;
if P == '1' && W == '0' then SEE VLDR;
if P == U && W == '1' then UNDEFINED;
// Remaining combinations are PUW = 010 (IA without !), 011 (IA with !), 101 (DB with !)
single_regs = FALSE; add = (U == '1'); wback = (W == '1');
d = UInt(D:Vd); n = UInt(Rn); imm32 = ZeroExtend(imm8:'00', 32);
regs = UInt(imm8) DIV 2; // If UInt(imm8) is odd, see "FLDMX".
if n == 15 && (wback || CurrentInstrSet() != InstrSet_ARM) then UNPREDICTABLE;
if regs == 0 || regs > 16 || (d+regs) > 32 then UNPREDICTABLE;
    
```

Encoding T2 / A2 VFPv2, VFPv3

VLDM{mode}<c> <Rn>{!}, <list> <list> is consecutive 32-bit registers

15	14	13	12	11	10	9	8	7	6	5	4	3	2	1	0	15	14	13	12	11	10	9	8	7	6	5	4	3	2	1	0																																																																																																																																																																																																																																																																																																																																																																																																																																																																																																
1	1	1	0	1	1	0	P	U	D	W	1	Rn				Vd				1	0	1	0	imm8																																																																																																																																																																																																																																																																																																																																																																																																																																																																																																							
31																30																29																28																27																26																25																24																23																22																21																20																19																18																17																16																15																14																13																12																11																10																9																8																7																6																5																4																3																2																1																0															
cond				1 1 0				P	U	D	W	1	Rn				Vd				1 0 1 0				imm8																																																																																																																																																																																																																																																																																																																																																																																																																																																																																																						

```

if P == '0' && U == '0' && W == '0' then SEE "Related encodings";
if P == '0' && U == '1' && W == '1' && Rn == '1101' then SEE VPOP;
if P == '1' && W == '0' then SEE VLDR;
if P == U && W == '1' then UNDEFINED;
// Remaining combinations are PUW = 010 (IA without !), 011 (IA with !), 101 (DB with !)
single_regs = TRUE; add = (U == '1'); wback = (W == '1'); d = UInt(Vd:D); n = UInt(Rn);
imm32 = ZeroExtend(imm8:'00', 32); regs = UInt(imm8);
if n == 15 && (wback || CurrentInstrSet() != InstrSet_ARM) then UNPREDICTABLE;
if regs == 0 || (d+regs) > 32 then UNPREDICTABLE;
    
```

Related encodings See 64-bit transfers between ARM core and extension registers on page A7-32

FLDMX Encoding T1/A1 behaves as described by the pseudocode if imm8 is odd. However, there is no UAL syntax for such encodings and their use is deprecated. For more information, see *FLDMX*, *FSTMX* on page A8-101.

Assembler syntax

VLDM{<mode>}<c><q>{.<size>} <Rn>{!}, <list>

where:

<mode>	The addressing mode: <ul style="list-style-type: none"> IA Increment After. The consecutive addresses start at the address specified in <Rn>. This is the default and can be omitted. Encoded as P = 0, U = 1. DB Decrement Before. The consecutive addresses end just before the address specified in <Rn>. Encoded as P = 1, U = 0.
<c><q>	See <i>Standard assembler syntax fields</i> on page A8-7.
<size>	An optional data size specifier. If present, it must be equal to the size in bits, 32 or 64, of the registers in <list>.
<Rn>	The base register. The SP can be used. In the ARM instruction set, if ! is not specified the PC can be used.
!	Causes the instruction to write a modified value back to <Rn>. This is required if <mode> == DB, and is optional if <mode> == IA. Encoded as W = 1. If ! is omitted, the instruction does not change <Rn> in this way. Encoded as W = 0.
<list>	The extension registers to be loaded, as a list of consecutively numbered doubleword (encoding T1 / A1) or singleword (encoding T2 / A2) registers, separated by commas and surrounded by brackets. It is encoded in the instruction by setting D and Vd to specify the first register in the list, and imm8 to twice the number of registers in the list (encoding T1 / A1) or the number of registers in the list (encoding T2 / A2). <list> must contain at least one register. If it contains doubleword registers it must not contain more than 16 registers.

Operation

```

if ConditionPassed() then
    EncodingSpecificOperations(); CheckVFPEnabled(TRUE); NullCheckIfThumbEE(n);
    address = if add then R[n] else R[n]-imm32;
    if wback then R[n] = if add then R[n]+imm32 else R[n]-imm32;
    for r = 0 to regs-1
        if single_regs then
            S[d+r] = MemA[address,4]; address = address+4;
        else
            word1 = MemA[address,4]; word2 = MemA[address+4,4]; address = address+8;
            // Combine the word-aligned words in the correct order for current endianness.
            D[d+r] = if BigEndian() then word1:word2 else word2:word1;

```

Exceptions

Undefined Instruction, Data Abort.

A8.6.320 VLDR

This instruction loads a single extension register from memory, using an address from an ARM core register, with an optional offset.

Encoding T1 / A1 VFPv2, VFPv3, Advanced SIMD

VLDR<c> <Dd>, [<Rn>{, #+/-<imm>}]

VLDR<c> <Dd>, <label>

VLDR<c> <Dd>, [PC, #-0] Special case

15	14	13	12	11	10	9	8	7	6	5	4	3	2	1	0	15	14	13	12	11	10	9	8	7	6	5	4	3	2	1	0
1	1	1	0	1	1	0	1	U	D	0	1	Rn				Vd				1	0	1	1	imm8							
31	30	29	28	27	26	25	24	23	22	21	20	19	18	17	16	15	14	13	12	11	10	9	8	7	6	5	4	3	2	1	0
cond				1	1	0	1	U	D	0	1	Rn				Vd				1	0	1	1	imm8							

single_reg = FALSE; add = (U == '1'); imm32 = ZeroExtend(imm8:'00', 32);
d = UInt(D:Vd); n = UInt(Rn);

Encoding T2 / A2 VFPv2, VFPv3

VLDR<c> <Sd>, [<Rn>{, #+/-<imm>}]

VLDR<c> <Sd>, <label>

VLDR<c> <Sd>, [PC, #-0] Special case

15	14	13	12	11	10	9	8	7	6	5	4	3	2	1	0	15	14	13	12	11	10	9	8	7	6	5	4	3	2	1	0
1	1	1	0	1	1	0	1	U	D	0	1	Rn				Vd				1	0	1	0	imm8							
31	30	29	28	27	26	25	24	23	22	21	20	19	18	17	16	15	14	13	12	11	10	9	8	7	6	5	4	3	2	1	0
cond				1	1	0	1	U	D	0	1	Rn				Vd				1	0	1	0	imm8							

single_reg = TRUE; add = (U == '1'); imm32 = ZeroExtend(imm8:'00', 32);
d = UInt(Vd:D); n = UInt(Rn);

Assembler syntax

VLDR<c><q>{.64} <Dd>, [<Rn> {, #+/-<imm>}]	Encoding T1 / A1, immediate form
VLDR<c><q>{.64} <Dd>, <label>	Encoding T1 / A1, normal literal form
VLDR<c><q>{.64} <Dd>, [PC, #+/-<imm>]	Encoding T1 / A1, alternative literal form
VLDR<c><q>{.32} <Sd>, [<Rn> {, #+/-<imm>}]	Encoding T2 / A2, immediate form
VLDR<c><q>{.32} <Sd>, <label>	Encoding T2 / A2, normal literal form
VLDR<c><q>{.32} <Sd>, [PC, #+/-<imm>]	Encoding T2 / A2, alternative literal form

where:

<c><q> See *Standard assembler syntax fields* on page A8-7.

.32, .64 Optional data size specifiers.

<Dd>	The destination register for a doubleword load.
<Sd>	The destination register for a singleword load.
<Rn>	The base register. The SP can be used.
+/-	Is + or omitted if the immediate offset is to be added to the base register value (add == TRUE), or – if it is to be subtracted (add == FALSE). #0 and #-0 generate different instructions.
<imm>	The immediate offset used to form the address. For the immediate forms of the syntax, <imm> can be omitted, in which case the #0 form of the instruction is assembled. Permitted values are multiples of 4 in the range 0 to 1020.
<label>	The label of the literal data item to be loaded. The assembler calculates the required value of the offset from the <code>Align(PC,4)</code> value of this instruction to the label. Permitted values are multiples of 4 in the range -1020 to 1020. If the offset is zero or positive, <code>imm32</code> is equal to the offset and <code>add == TRUE</code> . If the offset is negative, <code>imm32</code> is equal to minus the offset and <code>add == FALSE</code> .

For the literal forms of the instruction, the base register is encoded as '1111' to indicate that the PC is the base register.

The alternative syntax permits the addition or subtraction of the offset and the immediate offset to be specified separately, including permitting a subtraction of 0 that cannot be specified using the normal syntax. For more information, see *Use of labels in UAL instruction syntax* on page A4-5.

Operation

```

if ConditionPassed() then
    EncodingSpecificOperations(); CheckVFPEnabled(TRUE); NullCheckIfThumbEE(n);
    base = if n == 15 then Align(PC,4) else R[n];
    address = if add then (base + imm32) else (base - imm32);
    if single_reg then
        S[d] = MemA[address,4];
    else
        word1 = MemA[address,4]; word2 = MemA[address+4,4];
        // Combine the word-aligned words in the correct order for current endianness.
        D[d] = if BigEndian() then word1:word2 else word2:word1;

```

Exceptions

Undefined Instruction, Data Abort.

A8.6.321 VMAX, VMIN (integer)

Vector Maximum compares corresponding elements in two vectors, and copies the larger of each pair into the corresponding element in the destination vector.

Vector Minimum compares corresponding elements in two vectors, and copies the smaller of each pair into the corresponding element in the destination vector.

The operand vector elements can be any one of:

- 8-bit, 16-bit, or 32-bit signed integers
- 8-bit, 16-bit, or 32-bit unsigned integers.

The result vector elements are the same size as the operand vector elements.

Encoding T1 / A1 Advanced SIMD

V<op><c>.<dt> <Qd>, <Qn>, <Qm>

V<op><c>.<dt> <Dd>, <Dn>, <Dm>

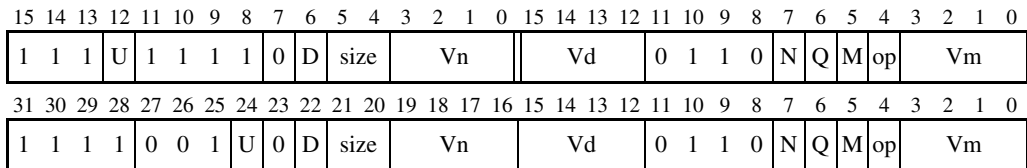

```

if Q == '1' && (Vd<0> == '1' || Vn<0> == '1' || Vm<0> == '1') then UNDEFINED;
if size == '11' then UNDEFINED;
maximum = (op == '0'); unsigned = (U == '1');
esize = 8 << UInt(size); elements = 64 DIV esize;
d = UInt(D:Vd); n = UInt(N:Vn); m = UInt(M:Vm); regs = if Q == '0' then 1 else 2;
    
```

Assembler syntax

V<op><c><q>.<dt> {<Qd>,<Qn>,<Qm>} Encoded as Q = 1
 V<op><c><q>.<dt> {<Dd>,<Dn>,<Dm>} Encoded as Q = 0

where:

<op> Must be one of:
 MAX encoded as op = 0
 MIN encoded as op = 1.

<c><q> See *Standard assembler syntax fields* on page A8-7. An ARM VMAX or VMIN instruction must be unconditional.

<dt> The data types for the elements of the vectors. It must be one of:
 S8 size = 0b00, U = 0
 S16 size = 0b01, U = 0
 S32 size = 0b10, U = 0
 U8 size = 0b00, U = 1
 U16 size = 0b01, U = 1
 U32 size = 0b10, U = 1.

<Qd>, <Qn>, <Qm> The destination vector and the operand vectors, for a quadword operation.

<Dd>, <Dn>, <Dm> The destination vector and the operand vectors, for a doubleword operation.

Operation

```
if ConditionPassed() then
  EncodingSpecificOperations(); CheckAdvSIMDEnabled();
  for r = 0 to regs-1
    for e = 0 to elements-1
      op1 = Int(Elem[D[n+r],e,esize], unsigned);
      op2 = Int(Elem[D[m+r],e,esize], unsigned);
      result = if maximum then Max(op1,op2) else Min(op1,op2);
      Elem[D[d+r],e,esize] = result<esize-1:0>;
```

Exceptions

Undefined Instruction.

A8.6.322 VMAX, VMIN (floating-point)

Vector Maximum compares corresponding elements in two vectors, and copies the larger of each pair into the corresponding element in the destination vector.

Vector Minimum compares corresponding elements in two vectors, and copies the smaller of each pair into the corresponding element in the destination vector.

The operand vector elements are 32-bit floating-point numbers.

Encoding T1 / A1 Advanced SIMD (UNDEFINED in integer-only variant)

V<op><c>.F32 <Qd>, <Qn>, <Qm>

V<op><c>.F32 <Dd>, <Dn>, <Dm>

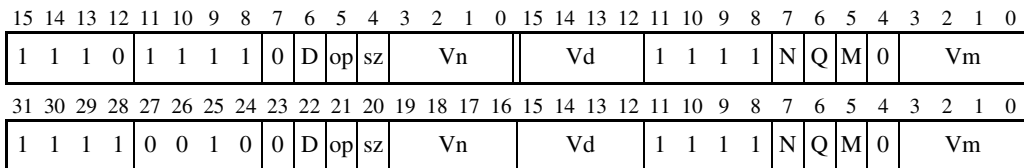

```

if Q == '1' && (Vd<0> == '1' || Vn<0> == '1' || Vm<0> == '1') then UNDEFINED;
if sz == '1' then UNDEFINED;
maximum = (op == '0'); esize = 32; elements = 2;
d = UInt(D:Vd); n = UInt(N:Vn); m = UInt(M:Vm); regs = if Q == '0' then 1 else 2;
    
```

Assembler syntax

V<op><c><q>.F32 {<Qd>}, <Qn>, <Qm> Encoded as Q = 1
 V<op><c><q>.F32 {<Dd>}, <Dn>, <Dm> Encoded as Q = 0

where:

<op> Must be one of:
 MAX encoded as op = 0
 MIN encoded as op = 1.

<c><q> See *Standard assembler syntax fields* on page A8-7. An ARM VMAX or VMIN instruction must be unconditional.

<Qd>, <Qn>, <Qm> The destination vector and the operand vectors, for a quadword operation.

<Dd>, <Dn>, <Dm> The destination vector and the operand vectors, for a doubleword operation.

Operation

```
if ConditionPassed() then
  EncodingSpecificOperations(); CheckAdvSIMDEnabled();
  for r = 0 to regs-1
    for e = 0 to elements-1
      op1 = Elem[D[n+r],e,esize]; op2 = Elem[D[m+r],e,esize];
      Elem[D[d+r],e,esize] = if maximum then FPMax(op1,op2,FALSE) else FPMin(op1,op2,FALSE);
```

Exceptions

Undefined Instruction.

Floating-point maximum and minimum

- $\max(+0.0, -0.0) = +0.0$
- $\min(+0.0, -0.0) = -0.0$
- If any input is a NaN, the corresponding result element is the default NaN.

A8.6.323 VMLA, VMLAL, VMLS, VMLSL (integer)

Vector Multiply Accumulate and Vector Multiply Subtract multiply corresponding elements in two vectors, and either add the products to, or subtract them from, the corresponding elements of the destination vector. Vector Multiply Accumulate Long and Vector Multiply Subtract Long do the same thing, but with destination vector elements that are twice as long as the elements that are multiplied.

Encoding T1 / A1 Advanced SIMD

V<op><c>.<dt> <Qd>, <Qn>, <Qm>

V<op><c>.<dt> <Dd>, <Dn>, <Dm>

	15	14	13	12	11	10	9	8	7	6	5	4	3	2	1	0		15	14	13	12	11	10	9	8	7	6	5	4	3	2	1	0
	1	1	1	op	1	1	1	1	0	D	size	Vn	Vd				1	0	0	1	N	Q	M	0	Vm								
	31	30	29	28	27	26	25	24	23	22	21	20	19	18	17	16	15	14	13	12	11	10	9	8	7	6	5	4	3	2	1	0	
	1	1	1	1	0	0	1	op	0	D	size	Vn	Vd				1	0	0	1	N	Q	M	0	Vm								

```

if size == '11' then UNDEFINED;
if Q == '1' && (Vd<0> == '1' || Vn<0> == '1' || Vm<0> == '1') then UNDEFINED;
add = (op == '0'); long_destination = FALSE;
unsigned = FALSE; // "Don't care" value: TRUE produces same functionality
esize = 8 << UInt(size); elements = 64 DIV esize;
d = UInt(D:Vd); n = UInt(N:Vn); m = UInt(M:Vm); regs = if Q == '0' then 1 else 2;
    
```

Encoding T2 / A2 Advanced SIMD

V<op>L<c>.<dt> <Qd>, <Dn>, <Dm>

	15	14	13	12	11	10	9	8	7	6	5	4	3	2	1	0		15	14	13	12	11	10	9	8	7	6	5	4	3	2	1	0
	1	1	1	U	1	1	1	1	1	D	size	Vn	Vd				1	0	op	0	N	0	M	0	Vm								
	31	30	29	28	27	26	25	24	23	22	21	20	19	18	17	16	15	14	13	12	11	10	9	8	7	6	5	4	3	2	1	0	
	1	1	1	1	0	0	1	U	1	D	size	Vn	Vd				1	0	op	0	N	0	M	0	Vm								

```

if size == '11' then SEE "Related encodings";
if Vd<0> == '1' then UNDEFINED;
add = (op == '0'); long_destination = TRUE; unsigned = (U == '1');
esize = 8 << UInt(size); elements = 64 DIV esize;
d = UInt(D:Vd); n = UInt(N:Vn); m = UInt(M:Vm); regs = 1;
    
```

Related encodings See *Advanced SIMD data-processing instructions* on page A7-10

Assembler syntax

V<op><c><q>.<type><size>	<Qd>, <Qn>, <Qm>	Encoding T1 / A1, Q = 1
V<op><c><q>.<type><size>	<Dd>, <Dn>, <Dm>	Encoding T1 / A1, Q = 0
V<op>L<c><q>.<type><size>	<Qd>, <Dn>, <Dm>	Encoding T2 / A2

where:

<op>	Must be either MLA (op = 0) or MLS (op = 1).
<c><q>	See <i>Standard assembler syntax fields</i> on page A8-7. An ARM Advanced SIMD VMLA, VMLAL, VMLS, or VMLSL instruction must be unconditional.
<type>	The data type for the elements of the operands. It must be one of: S Optional in encoding T1 / A1. U = 0 in encoding T2 / A2. U Optional in encoding T1 / A1. U = 1 in encoding T2 / A2. I Available only in encoding T1 / A1.
<size>	The data size for the elements of the operands. It must be one of: 8 encoded as size = 0b00 16 encoded as size = 0b01 32 encoded as size = 0b10.
<Qd>, <Qn>, <Qm>	The destination vector and the operand vectors, for a quadword operation.
<Dd>, <Dn>, <Dm>	The destination vector and the operand vectors, for a doubleword operation.
<Qd>, <Dn>, <Dm>	The destination vector and the operand vectors, for a long operation.

Operation

```

if ConditionPassed() then
    EncodingSpecificOperations(); CheckAdvSIMDEnabled();
    for r = 0 to regs-1
        for e = 0 to elements-1
            product = Int(Elem[D[n+r],e,esize],unsigned) * Int(Elem[D[m+r],e,esize],unsigned);
            addend = if add then product else -product;
            if long_destination then
                Elem[Q[d>>1],e,2*esize] = Elem[Q[d>>1],e,2*esize] + addend;
            else
                Elem[D[d+r],e,esize] = Elem[D[d+r],e,esize] + addend;

```

Exceptions

Undefined Instruction.

A8.6.324 VMLA, VMLS (floating-point)

Vector Multiply Accumulate multiplies corresponding elements in two vectors, and accumulates the results into the elements of the destination vector.

Vector Multiply Subtract multiplies corresponding elements in two vectors, subtracts the products from corresponding elements of the destination vector, and places the results in the destination vector.

Encoding T1 / A1 Advanced SIMD (UNDEFINED in integer-only variant)

V<op><c>.F32 <Qd>, <Qn>, <Qm>

V<op><c>.F32 <Dd>, <Dn>, <Dm>

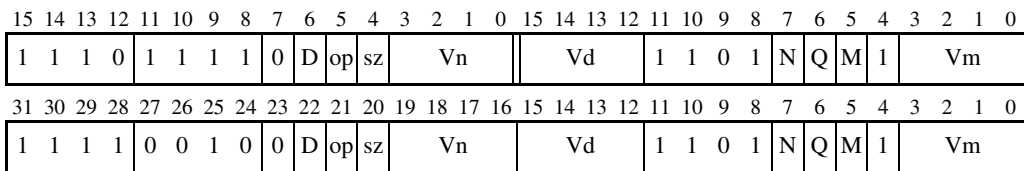

```

if Q == '1' && (Vd<0> == '1' || Vn<0> == '1' || Vm<0> == '1') then UNDEFINED;
if sz == '1' then UNDEFINED;
advsimd = TRUE; add = (op == '0'); esize = 32; elements = 2;
d = UInt(D:Vd); n = UInt(N:Vn); m = UInt(M:Vm); regs = if Q == '0' then 1 else 2;
    
```

Encoding T2 / A2 VFPv2, VFPv3 (sz = 1 UNDEFINED in single-precision only variants)

V<op><c>.F64 <Dd>, <Dn>, <Dm>

V<op><c>.F32 <Sd>, <Sn>, <Sm>

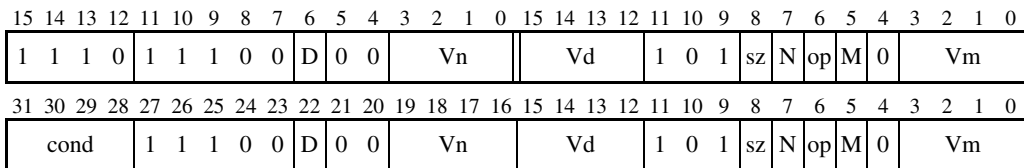

```

if FPSCR.LEN != '000' || FPSCR.STRIDE != '00' then SEE "VFP vectors";
advsimd = FALSE; dp_operation = (sz == '1'); add = (op == '0');
d = if dp_operation then UInt(D:Vd) else UInt(Vd:D);
n = if dp_operation then UInt(N:Vn) else UInt(Vn:N);
m = if dp_operation then UInt(M:Vm) else UInt(Vm:M);
    
```

VFP vectors Encoding T2 / A2 can operate on VFP vectors under control of the FPSCR.LEN and FPSCR.STRIDE bits. For details see Appendix F *VFP Vector Operation Support*.

Assembler syntax

V<op><c><q>.F32 <Qd>, <Qn>, <Qm>	Encoding T1 / A1, Q = 1, sz = 0
V<op><c><q>.F32 <Dd>, <Dn>, <Dm>	Encoding T1 / A1, Q = 0, sz = 0
V<op><c><q>.F64 <Dd>, <Dn>, <Dm>	Encoding T2 / A2, sz = 1
V<op><c><q>.F32 <Sd>, <Sn>, <Sm>	Encoding T2 / A2, sz = 0

where:

<op>	Must be either MLA (op = 0) or MLS (op = 1).
<c><q>	See <i>Standard assembler syntax fields</i> on page A8-7. An ARM Advanced SIMD VMLA or VMLS instruction must be unconditional.
<Qd>, <Qn>, <Qm>	The destination vector and the operand vectors, for a quadword operation.
<Dd>, <Dn>, <Dm>	The destination vector and the operand vectors, for a doubleword operation.
<Sd>, <Sn>, <Sm>	The destination vector and the operand vectors, for a singleword operation.

Operation

```

if ConditionPassed() then
    EncodingSpecificOperations(); CheckAdvSIMDorVFPEEnabled(TRUE, advsimd);
    if advsimd then // Advanced SIMD instruction
        for r = 0 to regs-1
            for e = 0 to elements-1
                product = FPMul(Elem[D[n+r],e,esize], Elem[D[m+r],e,esize], FALSE);
                addend = if add then product else FPNeg(product);
                Elem[D[d+r],e,esize] = FPAdd(Elem[D[d+r],e,esize], addend, FALSE);
    else // VFP instruction
        if dp_operation then
            addend = if add then FPMul(D[n], D[m], TRUE) else FPNeg(FPMul(D[n], D[m], TRUE));
            D[d] = FPAdd(D[d], addend, TRUE);
        else
            addend = if add then FPMul(S[n], S[m], TRUE) else FPNeg(FPMul(S[n], S[m], TRUE));
            S[d] = FPAdd(S[d], addend, TRUE);

```

Exceptions

Undefined Instruction.

Floating-point exceptions: Input Denormal, Invalid Operation, Overflow, Underflow, and Inexact.

A8.6.325 VMLA, VMLAL, VMLS, VMLSL (by scalar)

Vector Multiply Accumulate and Vector Multiply Subtract multiply elements of a vector by a scalar, and either add the products to, or subtract them from, corresponding elements of the destination vector. Vector Multiply Accumulate Long and Vector Multiply Subtract Long do the same thing, but with destination vector elements that are twice as long as the elements that are multiplied.

For more information about scalars see *Advanced SIMD scalars* on page A7-9.

Encoding T1 / A1 Advanced SIMD (F = 1 UNDEFINED in integer-only variants)

V<op><c>.<dt> <Qd>, <Qn>, <Dm[x]>

V<op><c>.<dt> <Dd>, <Dn>, <Dm[x]>

15	14	13	12	11	10	9	8	7	6	5	4	3	2	1	0	15	14	13	12	11	10	9	8	7	6	5	4	3	2	1	0
1	1	1	Q	1	1	1	1	1	D	size	Vn	Vd	0	op	0	F	N	1	M	0	Vm										
31	30	29	28	27	26	25	24	23	22	21	20	19	18	17	16	15	14	13	12	11	10	9	8	7	6	5	4	3	2	1	0
1	1	1	1	0	0	1	Q	1	D	size	Vn	Vd	0	op	0	F	N	1	M	0	Vm										

```

if size == '11' then SEE "Related encodings";
if size == '00' || (F == '1' && size == '01') then UNDEFINED;
if Q == '1' && (Vd<0> == '1' || Vn<0> == '1') then UNDEFINED;
unsigned = FALSE; // "Don't care" value: TRUE produces same functionality
add = (op == '0'); floating_point = (F == '1'); long_destination = FALSE;
d = UInt(D:Vd); n = UInt(N:Vn); regs = if Q == '0' then 1 else 2;
if size == '01' then esize = 16; elements = 4; m = UInt(Vm<2:0>); index = UInt(M:Vm<3>);
if size == '10' then esize = 32; elements = 2; m = UInt(Vm); index = UInt(M);
    
```

Encoding T2 / A2 Advanced SIMD

V<op>L<c>.<dt> <Qd>, <Dn>, <Dm[x]>

15	14	13	12	11	10	9	8	7	6	5	4	3	2	1	0	15	14	13	12	11	10	9	8	7	6	5	4	3	2	1	0
1	1	1	U	1	1	1	1	1	D	size	Vn	Vd	0	op	1	0	N	1	M	0	Vm										
31	30	29	28	27	26	25	24	23	22	21	20	19	18	17	16	15	14	13	12	11	10	9	8	7	6	5	4	3	2	1	0
1	1	1	1	0	0	1	U	1	D	size	Vn	Vd	0	op	1	0	N	1	M	0	Vm										

```

if size == '11' then SEE "Related encodings";
if size == '00' || Vd<0> == '1' then UNDEFINED;
unsigned = (U == '1'); add = (op == '0'); floating_point = FALSE; long_destination = TRUE;
d = UInt(D:Vd); n = UInt(N:Vn); regs = 1;
if size == '01' then esize = 16; elements = 4; m = UInt(Vm<2:0>); index = UInt(M:Vm<3>);
if size == '10' then esize = 32; elements = 2; m = UInt(Vm); index = UInt(M);
    
```

Related encodings See *Advanced SIMD data-processing instructions* on page A7-10

Assembler syntax

V<op><c><q>.<type><size> <Qd>, <Qn>, <Dm[x]>	Encoding T1 / A1, Q = 1
V<op><c><q>.<type><size> <Dd>, <Dn>, <Dm[x]>	Encoding T1 / A1, Q = 0
V<op>L<c><q>.<type><size> <Qd>, <Dn>, <Dm[x]>	Encoding T2 / A2

where:

<op>	Must be either MLA (encoded as op = 0) or MLS (encoded as op = 1).
<c><q>	See <i>Standard assembler syntax fields</i> on page A8-7. An ARM Advanced SIMD VMLA, VMLAL, VMLS, or VMLS instruction must be unconditional.
<type>	The data type for the elements of the operands. It must be one of: <ul style="list-style-type: none"> S encoding T2 / A2, U = '0'. U encoding T2 / A2, U = '1'. I encoding T1 / A1, F = '0'. F encoding T1 / A1, F = '1'. <size> must be 32.
<size>	The operand element data size. It can be 16 (size = '01') or 32 (size = '10').
<Qd>, <Qn>	The accumulate vector, and the operand vector, for a quadword operation.
<Dd>, <Dn>	The accumulate vector, and the operand vector, for a doubleword operation.
<Qd>, <Dn>	The accumulate vector, and the operand vector, for a long operation.
<Dm[x]>	The scalar. Dm is restricted to D0-D7 if <size> is 16, or D0-D15 otherwise.

Operation

```

if ConditionPassed() then
    EncodingSpecificOperations(); CheckAdvSIMDEnabled();
    op2 = Elem[D[m],index,esize]; op2val = Int(op2, unsigned);
    for r = 0 to regs-1
        for e = 0 to elements-1
            op1 = Elem[D[n+r],e,esize]; op1val = Int(op1, unsigned);
            if floating_point then
                fp_addend = if add then FPMul(op1,op2,FALSE) else FPNeg(FPMul(op1,op2,FALSE));
                Elem[D[d+r],e,esize] = FPAdd(Elem[D[d+r],e,esize], fp_addend, FALSE);
            else
                addend = if add then op1val*op2val else -op1val*op2val;
                if long_destination then
                    Elem[Q[d>>1],e,2*esize] = Elem[Q[d>>1],e,2*esize] + addend;
                else
                    Elem[D[d+r],e,esize] = Elem[D[d+r],e,esize] + addend;

```

Exceptions

Undefined Instruction. Floating-point exceptions: Input Denormal, Invalid Operation, Overflow, Underflow, and Inexact.

A8.6.326 VMOV (immediate)

This instruction places an immediate constant into every element of the destination register.

Encoding T1 / A1 Advanced SIMD

VMOV<c>.<dt> <Qd>, #<imm>

VMOV<c>.<dt> <Dd>, #<imm>

15	14	13	12	11	10	9	8	7	6	5	4	3	2	1	0	15	14	13	12	11	10	9	8	7	6	5	4	3	2	1	0
1	1	1	i	1	1	1	1	1	D	0	0	0	imm3		Vd		cmode	0	Q	op	1		imm4								
31	30	29	28	27	26	25	24	23	22	21	20	19	18	17	16	15	14	13	12	11	10	9	8	7	6	5	4	3	2	1	0
1	1	1	1	0	0	1	i	1	1	D	0	0	0	imm3		Vd		cmode	0	Q	op	1		imm4							

```

if op == '0' && cmode<0> == '1' && cmode<3:2> != '11' then SEE VORR (immediate);
if op == '1' && cmode != '1110' then SEE "Related encodings";
if Q == '1' && Vd<0> == '1' then UNDEFINED;
single_register = FALSE; advsimd = TRUE; imm64 = AdvSIMDExpandImm(op, cmode, i:imm3:imm4);
d = UInt(D:Vd); regs = if Q == '0' then 1 else 2;

```

Encoding T2 / A2 VFPv3 (sz = 1 UNDEFINED in single-precision only variants)

VMOV<c>.F64 <Dd>, #<imm>

VMOV<c>.F32 <Sd>, #<imm>

15	14	13	12	11	10	9	8	7	6	5	4	3	2	1	0	15	14	13	12	11	10	9	8	7	6	5	4	3	2	1	0
1	1	1	0	1	1	1	0	1	D	1	1	imm4H		Vd		1	0	1	sz	(0)	0	(0)	0		imm4L						
31	30	29	28	27	26	25	24	23	22	21	20	19	18	17	16	15	14	13	12	11	10	9	8	7	6	5	4	3	2	1	0
	cond			1	1	1	0	1	D	1	1	imm4H		Vd		1	0	1	sz	(0)	0	(0)	0		imm4L						

```

if FPSCR.LEN != '000' || FPSCR.STRIDE != '00' then SEE "VFP vectors";
single_register = (sz == '0'); advsimd = FALSE;
if single_register then
    d = UInt(Vd:D); imm32 = VFPEExpandImm(imm4H:imm4L, 32);
else
    d = UInt(D:Vd); imm64 = VFPEExpandImm(imm4H:imm4L, 64); regs = 1;

```

Related encodings See *One register and a modified immediate value* on page A7-21

VFP vectors

Encoding T2 / A2 can operate on VFP vectors under control of the FPSCR.LEN and FPSCR.STRIDE bits. For details see Appendix F *VFP Vector Operation Support*.

Assembler syntax

VMOV<c><q>.<dt> <Qd>, #<imm>	Encoding T1 / A1, Q = 1
VMOV<c><q>.<dt> <Dd>, #<imm>	Encoding T1 / A1, Q = 0
VMOV<c>.<F64> <Dd>, #<imm>	Encoding T2 / A2, sz = 1
VMOV<c>.<F32> <Sd>, #<imm>	Encoding T2 / A2, sz = 0

where:

<c><q>	See <i>Standard assembler syntax fields</i> on page A8-7. An ARM Advanced SIMD VMOV (immediate) instruction must be unconditional.
<dt>	The data type. It must be one of I8, I16, I32, I64, or F32.
<Qd>	The destination register for a quadword operation.
<Dd>	The destination register for a doubleword operation.
<Sd>	The destination register for a singleword operation.
<imm>	A constant of the type specified by <dt>. This constant is replicated enough times to fill the destination register. For example, VMOV.I32 D0, #10 writes 0x0000000A0000000A to D0.

For the range of constants available, and the encoding of <dt> and <imm>, see:

- *One register and a modified immediate value* on page A7-21 for encoding T1 / A1
- *VFP data-processing instructions* on page A7-24 for encoding T2 / A2.

Operation

```

if ConditionPassed() then
    EncodingSpecificOperations(); CheckAdvSIMDorVFPEEnabled(TRUE, advsimd);
    if single_register then
        S[d] = imm32;
    else
        for r = 0 to regs-1
            D[d+r] = imm64;

```

Exceptions

Undefined Instruction.

Pseudo-instructions

One register and a modified immediate value on page A7-21 describes pseudo-instructions with a combination of <dt> and <imm> that is not supported by hardware, but that generates the same destination register value as a different combination that is supported by hardware.

A8.6.327 VMOV (register)

This instruction copies the contents of one register to another.

Encoding T1 / A1 Advanced SIMD

VMOV<c> <Qd>, <Qm>

VMOV<c> <Dd>, <Dm>

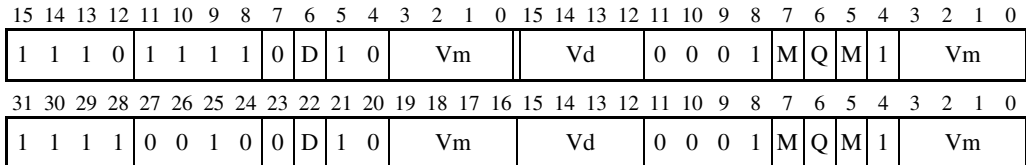

```

if !Consistent(M) || !Consistent(Vm) then SEE VORR (register);
if Q == '1' && (Vd<0> == '1' || Vm<0> == '1') then UNDEFINED;
single_register = FALSE; advsimd = TRUE;
d = UInt(D:Vd); m = UInt(M:Vm); regs = if Q == '0' then 1 else 2;
    
```

Encoding T2 / A2 VFPv2, VFPv3 (sz = 1 UNDEFINED in single-precision only variants)

VMOV<c>.F64 <Dd>, <Dm>

VMOV<c>.F32 <Sd>, <Sm>

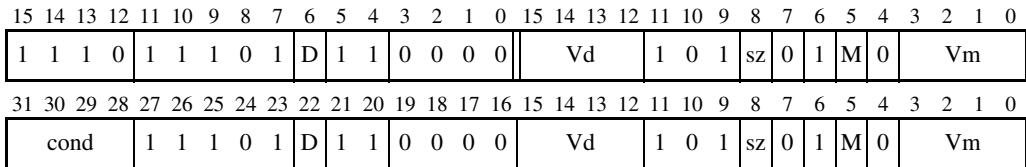

```

if FPSCR.LEN != '000' || FPSCR.STRIDE != '00' then SEE "VFP vectors";
single_register = (sz == '0'); advsimd = FALSE;
if single_register then
    d = UInt(Vd:D); m = UInt(Vm:M);
else
    d = UInt(D:Vd); m = UInt(M:Vm); regs = 1;
    
```

VFP vectors Encoding T2 / A2 can operate on VFP vectors under control of the FPSCR.LEN and FPSCR.STRIDE bits. For details see Appendix F *VFP Vector Operation Support*.

Assembler syntax

VMOV<c><q>{.<dt>} <Qd>, <Qm>	Encoding T1 / A1, Q = 1
VMOV<c><q>{.<dt>} <Dd>, <Dm>	Encoding T1 / A1, Q = 0
VMOV<c><q>.F64 <Dd>, <Dm>	Encoding T2 / A2, sz = 1
VMOV<c><q>.F32 <Sd>, <Sm>	Encoding T2 / A2, sz = 0

where:

<c><q>	See <i>Standard assembler syntax fields</i> on page A8-7. An ARM Advanced SIMD VMOV (register) instruction must be unconditional.
<dt>	An optional data type. <dt> must not be F64, but it is otherwise ignored.
<Qd>, <Qm>	The destination register and the source register, for a quadword operation.
<Dd>, <Dm>	The destination register and the source register, for a doubleword operation.
<Sd>, <Sm>	The destination register and the source register, for a singleword operation.

Operation

```

if ConditionPassed() then
    EncodingSpecificOperations(); CheckAdvSIMDorVFPEEnabled(TRUE, advsimd);
    if single_register then
        S[d] = S[m];
    else
        for r = 0 to regs-1
            D[d+r] = D[m+r];

```

Exceptions

Undefined Instruction.

A8.6.328 VMOV (ARM core register to scalar)

This instruction copies a byte, halfword, or word from an ARM core register into an Advanced SIMD scalar.

On a VFP-only system, this instruction transfers one word to the upper or lower half of a double-precision floating-point register from an ARM core register. This is an identical operation to the Advanced SIMD single word transfer.

For more information about scalars see *Advanced SIMD scalars* on page A7-9.

Encoding T1 / A1 VFPv2, VFPv3, Advanced SIMD if `opc1 == '0x' && opc2 == '00'`
 Advanced SIMD otherwise

VMOV<c>.<size> <Dd[x]>, <Rt>

15	14	13	12	11	10	9	8	7	6	5	4	3	2	1	0	15	14	13	12	11	10	9	8	7	6	5	4	3	2	1	0			
1	1	1	0	1	1	1	0	0	opc1	0		Vd											Rt	1	0	1	1	D	opc2	1	(0)	(0)	(0)	(0)
31	30	29	28	27	26	25	24	23	22	21	20	19	18	17	16	15	14	13	12	11	10	9	8	7	6	5	4	3	2	1	0			
cond		1	1	1	0	0	opc1	0		Vd													Rt	1	0	1	1	D	opc2	1	(0)	(0)	(0)	(0)

```

case opc1:opc2 of
    when '1xxx' advsimd = TRUE; esize = 8; index = UInt(opc1<0>:opc2);
    when '0xx1' advsimd = TRUE; esize = 16; index = UInt(opc1<0>:opc2<1>);
    when '0x00' advsimd = FALSE; esize = 32; index = UInt(opc1<0>);
    when '0x10' UNDEFINED;
d = UInt(D:Vd); t = UInt(Rt);
if t == 15 || (CurrentInstrSet() != InstrSet_ARM && t == 13) then UNPREDICTABLE;
    
```

Assembler syntax

VMOV<c>{.,<size>} <Dd[x]>, <Rt>

where:

<c><q>	See <i>Standard assembler syntax fields</i> on page A8-7.								
<size>	The data size. It must be one of: <table> <tr> <td>8</td> <td>Encoded as <code>opc1<1> = 1</code>. [x] is encoded in <code>opc1<0></code>, <code>opc2</code>.</td> </tr> <tr> <td>16</td> <td>Encoded as <code>opc1<1></code>, <code>opc2<0> = 0b01</code>. [x] is encoded in <code>opc1<0></code>, <code>opc2<1></code>.</td> </tr> <tr> <td>32</td> <td>Encoded as <code>opc1<1></code>, <code>opc2 = 0b000</code>. [x] is encoded in <code>opc1<0></code>.</td> </tr> <tr> <td>omitted</td> <td>equivalent to 32.</td> </tr> </table>	8	Encoded as <code>opc1<1> = 1</code> . [x] is encoded in <code>opc1<0></code> , <code>opc2</code> .	16	Encoded as <code>opc1<1></code> , <code>opc2<0> = 0b01</code> . [x] is encoded in <code>opc1<0></code> , <code>opc2<1></code> .	32	Encoded as <code>opc1<1></code> , <code>opc2 = 0b000</code> . [x] is encoded in <code>opc1<0></code> .	omitted	equivalent to 32.
8	Encoded as <code>opc1<1> = 1</code> . [x] is encoded in <code>opc1<0></code> , <code>opc2</code> .								
16	Encoded as <code>opc1<1></code> , <code>opc2<0> = 0b01</code> . [x] is encoded in <code>opc1<0></code> , <code>opc2<1></code> .								
32	Encoded as <code>opc1<1></code> , <code>opc2 = 0b000</code> . [x] is encoded in <code>opc1<0></code> .								
omitted	equivalent to 32.								
<Dd[x]>	The scalar. The register <Dd> is encoded in D:Vd. For details of how [x] is encoded, see the description of <size>.								
<Rt>	The source ARM core register.								

Operation

```
if ConditionPassed() then
    EncodingSpecificOperations(); CheckAdvSIMDorVFPEEnabled(TRUE, advsimd);
    Elem[D[d+r],index,esize] = R[t]<esize-1:0>;
```

Exceptions

Undefined Instruction.

A8.6.329 VMOV (scalar to ARM core register)

This instruction copies a byte, halfword, or word from an Advanced SIMD scalar to an ARM core register. Bytes and halfwords can be either zero-extended or sign-extended.

On a VFP-only system, this instruction transfers one word from the upper or lower half of a double-precision floating-point register to an ARM core register. This is an identical operation to the Advanced SIMD single word transfer.

For more information about scalars see *Advanced SIMD scalars* on page A7-9.

Encoding T1 / A1 VFPv2, VFPv3, Advanced SIMD if `opc1 == '0x' && opc2 == '00'`
 Advanced SIMD otherwise

VMOV<c>.<dt> <Rt>, <Dn[x]>

15	14	13	12	11	10	9	8	7	6	5	4	3	2	1	0	15	14	13	12	11	10	9	8	7	6	5	4	3	2	1	0		
1	1	1	0	1	1	1	0	U	opc1	1	Vn				Rt				1	0	1	1	N	opc2	1	(0)	(0)	(0)	(0)				
31	30	29	28	27	26	25	24	23	22	21	20	19	18	17	16	15	14	13	12	11	10	9	8	7	6	5	4	3	2	1	0		
cond								1	1	1	0	U	opc1	1	Vn				Rt				1	0	1	1	N	opc2	1	(0)	(0)	(0)	(0)

```

case U:opc1:opc2 of
    when 'x1xxx' advsimd = TRUE; esize = 8; index = UInt(opc1<0>:opc2);
    when 'x0xx1' advsimd = TRUE; esize = 16; index = UInt(opc1<0>:opc2<1>);
    when '00x00' advsimd = FALSE; esize = 32; index = UInt(opc1<0>);
    when '10x00' UNDEFINED;
    when 'x0x10' UNDEFINED;
t = UInt(Rt); n = UInt(N:Vn); unsigned = (U == '1');
if t == 15 || (CurrentInstrSet() != InstrSet_ARM && t == 13) then UNPREDICTABLE;
    
```

Assembler syntax

VMOV<c>{.,<dt>} <Rt>, <Dn[x]>

where:

<c><q> See *Standard assembler syntax fields* on page A8-7.

<dt> The data type. It must be one of:

S8 Encoded as `opc1<2:1>='01'` [x] is encoded in `opc1<0>`, `opc2`.

S16 Encoded as `opc1<2:1>,opc2<0>='001'` [x] is encoded in `opc1<0>`, `opc2<1>`.

U8 Encoded as `opc1<2:1>='11'` [x] is encoded in `opc1<0>`, `opc2`.

U16 Encoded as `opc1<2:1>,opc2<0>='101'` [x] is encoded in `opc1<0>`, `opc2<1>`.

32 Encoded as `opc1<2:1>,opc2<1:0>='0000'` [x] is encoded in `opc1<0>`.

omitted equivalent to 32.

<Dn[x]> The scalar. For details of how [x] is encoded see the description of <dt>.

<Rt> The destination ARM core register.

Operation

```
if ConditionPassed() then
    EncodingSpecificOperations(); CheckAdvSIMDorVFPEEnabled(TRUE, advsimd);
    if unsigned then
        R[t] = ZeroExtend(Elem[D[n+r],index,esize]);
    else
        R[t] = SignExtend(Elem[D[n+r],index,esize]);
```

Exceptions

Undefined Instruction.

A8.6.330 VMOV (between ARM core register and single-precision register)

This instruction transfers the contents of a single-precision VFP register to an ARM core register, or the contents of an ARM core register to a single-precision VFP register.

Encoding T1 / A1 VFPv2, VFPv3

VMOV<C> <Sn>, <Rt>

VMOV<C> <Rt>, <Sn>

15	14	13	12	11	10	9	8	7	6	5	4	3	2	1	0	15	14	13	12	11	10	9	8	7	6	5	4	3	2	1	0
1	1	1	0	1	1	1	0	0	0	0	op	Vn			Rt			1	0	1	0	N	(0)	(0)	1	(0)	(0)	(0)	(0)		
31	30	29	28	27	26	25	24	23	22	21	20	19	18	17	16	15	14	13	12	11	10	9	8	7	6	5	4	3	2	1	0
cond			1	1	1	0	0	0	0	op	Vn			Rt			1	0	1	0	N	(0)	(0)	1	(0)	(0)	(0)	(0)			

```
to_arm_register = (op == '1'); t = UInt(Rt); n = UInt(Vn:N);
if t == 15 || (CurrentInstrSet() != InstrSet_ARM && t == 13) then UNPREDICTABLE;
```

Assembler syntax

VMOV<c><q> <Sn>, <Rt>

Encoded as op = 0

VMOV<c><q> <Rt>, <Sn>

Encoded as op = 1

where:

<c><q> See *Standard assembler syntax fields* on page A8-7.

<Sn> The single-precision VFP register.

<Rt> The ARM core register.

Operation

```

if ConditionPassed() then
    EncodingSpecificOperations(); CheckVFPEEnabled(TRUE);
    if to_arm_register then
        R[t] = S[n];
    else
        S[n] = R[t];

```

Exceptions

Undefined Instruction.

A8.6.331 VMOV (between two ARM core registers and two single-precision registers)

This instruction transfers the contents of two consecutively numbered single-precision VFP registers to two ARM core registers, or the contents of two ARM core registers to a pair of single-precision VFP registers. The ARM core registers do not have to be contiguous.

Encoding T1 / A1 VFPv2, VFPv3

VMOV<c> <Sm>, <Sm1>, <Rt>, <Rt2>

VMOV<c> <Rt>, <Rt2>, <Sm>, <Sm1>

15	14	13	12	11	10	9	8	7	6	5	4	3	2	1	0	15	14	13	12	11	10	9	8	7	6	5	4	3	2	1	0
1	1	1	0	1	1	0	0	0	1	0	op	Rt2			Rt			1	0	1	0	0	0	M	1	Vm					
31	30	29	28	27	26	25	24	23	22	21	20	19	18	17	16	15	14	13	12	11	10	9	8	7	6	5	4	3	2	1	0
cond			1	1	0	0	0	1	0	op	Rt2			Rt			1	0	1	0	0	0	M	1	Vm						

```

to_arm_registers = (op == '1'); t = UInt(Rt); t2 = UInt(Rt2); m = UInt(Vm:M);
if t == 15 || t2 == 15 || m == 31 then UNPREDICTABLE;
if CurrentInstrSet() != InstrSet_ARM && (t == 13 || t2 == 13) then UNPREDICTABLE;
if to_arm_registers && t == t2 then UNPREDICTABLE;
    
```

Assembler syntax

VMOV<c><q> <Sm>, <Sm1>, <Rt>, <Rt2> Encoded as op = 0
 VMOV<c><q> <Rt>, <Rt2>, <Sm>, <Sm1> Encoded as op = 1

where:

<c><q> See *Standard assembler syntax fields* on page A8-7.
 <Sm> The first single-precision VFP register.
 <Sm1> The second single-precision VFP register. This is the next single-precision VFP register after <Sm>.
 <Rt> The ARM core register that <Sm> is transferred to or from.
 <Rt2> The ARM core register that <Sm1> is transferred to or from.

Operation

```
if ConditionPassed() then
  EncodingSpecificOperations(); CheckVFPEnabled(TRUE);
  if to_arm_registers then
    R[t] = S[m];
    R[t2] = S[m+1];
  else
    S[m] = R[t];
    S[m+1] = R[t2];
```

Exceptions

Undefined Instruction.

A8.6.332 VMOV (between two ARM core registers and a doubleword extension register)

This instruction copies two words from two ARM core registers into a doubleword extension register, or from a doubleword extension register to two ARM core registers.

Encoding T1 / A1 VFPv2, VFPv3, Advanced SIMD

VMOV<c> <Dm>, <Rt>, <Rt2>

VMOV<c> <Rt>, <Rt2>, <Dm>

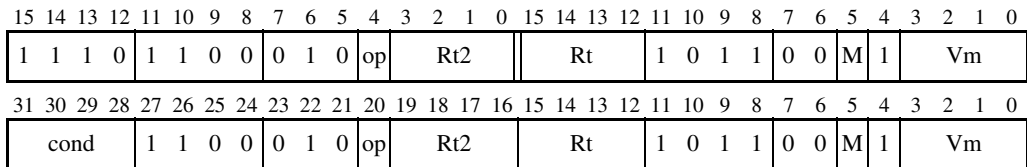

```

to_arm_registers = (op == '1'); t = UInt(Rd); t2 = UInt(Rt2); m = UInt(M:Vm);
if t == 15 || t2 == 15 then UNPREDICTABLE;
if CurrentInstrSet() != InstrSet_ARM && (t == 13 || t2 == 13) then UNPREDICTABLE;
if to_arm_registers && t == t2 then UNPREDICTABLE;
    
```

Assembler syntax

VMOV<c><q> <Dm>, <Rt>, <Rt2> Encoded as op = 0
 VMOV<c><q> <Rt>, <Rt2>, <Dm> Encoded as op = 1

where:

<c><q> See *Standard assembler syntax fields* on page A8-7.
 <Dm> The doubleword extension register.
 <Rt>, <Rt2> The two ARM core registers.

Operation

```
if ConditionPassed() then
  EncodingSpecificOperations(); CheckVFPEnabled(TRUE);
  if to_arm_registers then
    R[t] = D[m]<31:0>;
    R[t2] = D[m]<63:32>;
  else
    D[m]<31:0> = R[t];
    D[m]<63:32> = R[t2];
```

Exceptions

Undefined Instruction.

A8.6.333 VMOVL

Vector Move Long takes each element in a doubleword vector, sign or zero-extends them to twice their original length, and places the results in a quadword vector.

Encoding T1 / A1 Advanced SIMD

VMOVL<c>.<dt> <Qd>, <Dm>

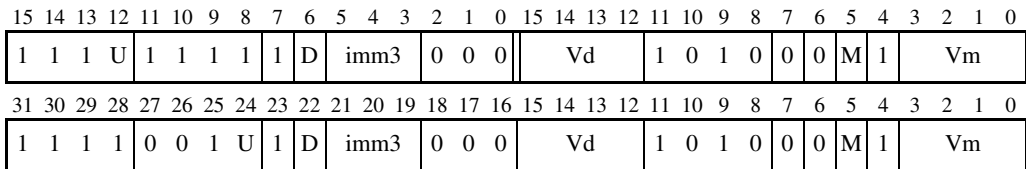

```

if imm3 == '000' then SEE "Related encodings";
if imm3 != '001' && imm3 != '010' && imm3 != '100' then SEE VSHLL;
if Vd<0> == '1' then UNDEFINED;
esize = 8 * UInt(imm3);
unsigned = (U == '1'); elements = 64 DIV esize;
d = UInt(D:Vd); m = UInt(M:Vm);
    
```

Related encodings See *One register and a modified immediate value* on page A7-21

Assembler syntax

VMOVL<C><Q>.dt <Qd>, <Dm>

where:

<C><Q> See *Standard assembler syntax fields* on page A8-7. An ARM VMOVL instruction must be unconditional.

<dt> The data type for the elements of the operand. It must be one of:

S8 encoded as U = 0, imm3 = '001'

S16 encoded as U = 0, imm3 = '010'

S32 encoded as U = 0, imm3 = '100'

U8 encoded as U = 1, imm3 = '001'

U16 encoded as U = 1, imm3 = '010'

U32 encoded as U = 1, imm3 = '100'.

<Qd>, <Dm> The destination vector and the operand vector.

Operation

```
if ConditionPassed() then
    EncodingSpecificOperations(); CheckAdvSIMDEnabled();
    for e = 0 to elements-1
        result = Int(Elem[D[m],e,esize], unsigned);
        Elem[Q[d>>1],e,2*esize] = result<2*esize-1:0>;
```

Exceptions

Undefined Instruction.

A8.6.334 VMOVN

Vector Move and Narrow copies the least significant half of each element of a quadword vector into the corresponding elements of a doubleword vector.

The operand vector elements can be any one of 16-bit, 32-bit, or 64-bit integers. There is no distinction between signed and unsigned integers.

Encoding T1 / A1 Advanced SIMD

VMOVN<c>.<dt> <Dd>, <Qm>

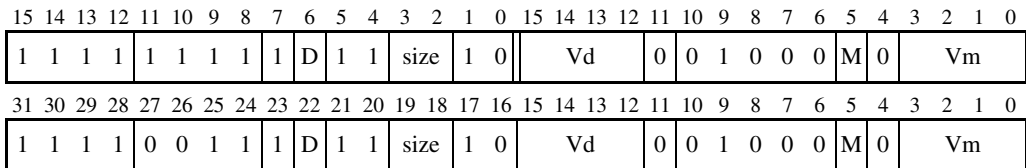

```

if size == '11' then UNDEFINED;
if Vm<0> == '1' then UNDEFINED;
esize = 8 << UInt(size); elements = 64 DIV esize;
d = UInt(D:Vd); m = UInt(M:Vm);
    
```

Assembler syntax

VMOVN<C><q>.<dt> <Dd>, <Qm>

where:

<C><q> See *Standard assembler syntax fields* on page A8-7. An ARM VMOVN instruction must be unconditional.

<dt> The data type for the elements of the operand. It must be one of:
 I16 encoded as size = 0b00
 I32 encoded as size = 0b01
 I64 encoded as size = 0b10.

<Dd>, <Qm> The destination vector and the operand vector.

Operation

```
if ConditionPassed() then
    EncodingSpecificOperations(); CheckAdvSIMDEnabled();
    for e = 0 to elements-1
        Elem[D[d],e,esize] = Elem[Q[m>1],e,2*esize]<esize-1:0>;
```

Exceptions

Undefined Instruction.

A8.6.335 VMRS

Move to ARM core register from Advanced SIMD and VFP extension System Register moves the value of the FPSCR to a general-purpose register.

For details of system level use of this instruction, see *VMRS* on page B6-27.

Encoding T1 / A1 VFPv2, VFPv3, Advanced SIMD

VMRS<c> <Rt>, FPSCR

15	14	13	12	11	10	9	8	7	6	5	4	3	2	1	0	15	14	13	12	11	10	9	8	7	6	5	4	3	2	1	0
1	1	1	0	1	1	1	0	1	1	1	1	0	0	0	0	1	Rt	1	0	1	0	0	(0)	(0)	1	(0)	(0)	(0)	(0)		
31	30	29	28	27	26	25	24	23	22	21	20	19	18	17	16	15	14	13	12	11	10	9	8	7	6	5	4	3	2	1	0
cond				1	1	1	0	1	1	1	1	0	0	0	0	1	Rt	1	0	1	0	0	(0)	(0)	1	(0)	(0)	(0)	(0)		

t = UInt(Rt);

if t == 13 && CurrentInstrSet() != InstrSet_ARM then UNPREDICTABLE;

Assembler syntax

VMRS<c><q> <Rt>, FPSCR

where:

<c><q> See *Standard assembler syntax fields* on page A8-7.

<Rt> The destination ARM core register. This register can be R0-R14 or APSR_nzcv. APSR_nzcv is encoded as Rt = '1111', and the instruction transfers the FPSCR N, Z, C, and V flags to the APSR N, Z, C, and V flags.

The pre-UAL instruction FMSTAT is equivalent to VMRS APSR_nzcv, FPSCR.

Operation

```

if ConditionPassed() then
    EncodingSpecificOperations(); CheckVFPEnabled(TRUE);
    SerializeVFP(); VFPExcBarrier();
    if t != 15 then
        R[t] = FPSCR;
    else
        APSR.N = FPSCR.N;
        APSR.Z = FPSCR.Z;
        APSR.C = FPSCR.C;
        APSR.V = FPSCR.V;

```

Exceptions

Undefined Instruction.

A8.6.336 VMSR

Move to Advanced SIMD and VFP extension System Register from ARM core register moves the value of a general-purpose register to the FPSCR.

For details of system level use of this instruction, see *VMSR* on page B6-29.

Encoding T1 / A1 VFPv2, VFPv3, Advanced SIMD

VMSR<c> FPSCR, <Rt>

15	14	13	12	11	10	9	8	7	6	5	4	3	2	1	0	15	14	13	12	11	10	9	8	7	6	5	4	3	2	1	0
1	1	1	0	1	1	1	0	1	1	1	0	0	0	0	1	Rt	1	0	1	0	0	(0)	(0)	1	(0)	(0)	(0)	(0)			
31	30	29	28	27	26	25	24	23	22	21	20	19	18	17	16	15	14	13	12	11	10	9	8	7	6	5	4	3	2	1	0
cond				1	1	1	0	1	1	1	0	0	0	0	1	Rt	1	0	1	0	0	(0)	(0)	1	(0)	(0)	(0)	(0)			

t = UInt(Rt);

if t == 15 || (t == 13 && CurrentInstrSet() != InstrSet_ARM) then UNPREDICTABLE;

Assembler syntax

VMSR<c><q> FPSCR, <Rt>

where:

<c><q> See *Standard assembler syntax fields* on page A8-7.

<Rt> The general-purpose register to be transferred to the FPSCR.

Operation

```
if ConditionPassed() then
    EncodingSpecificOperations(); CheckVFPEnabled(TRUE);
    SerializeVFP(); VFPExcBarrier();
    FPSCR = R[t];
```

Exceptions

Undefined Instruction.

A8.6.337 VMUL, VMULL (integer and polynomial)

Vector Multiply multiplies corresponding elements in two vectors. Vector Multiply Long does the same thing, but with destination vector elements that are twice as long as the elements that are multiplied.

For information about multiplying polynomials see *Polynomial arithmetic over {0,1}* on page A2-67.

Encoding T1 / A1 Advanced SIMD

VMUL<c>.<dt> <Qd>, <Qn>, <Qm>

VMUL<c>.<dt> <Dd>, <Dn>, <Dm>

15	14	13	12	11	10	9	8	7	6	5	4	3	2	1	0	15	14	13	12	11	10	9	8	7	6	5	4	3	2	1	0
1	1	1	op	1	1	1	1	0	D	size	Vn	Vd	1	0	0	1	N	Q	M	1	Vm										
31	30	29	28	27	26	25	24	23	22	21	20	19	18	17	16	15	14	13	12	11	10	9	8	7	6	5	4	3	2	1	0
1	1	1	1	0	0	1	op	0	D	size	Vn	Vd	1	0	0	1	N	Q	M	1	Vm										

```

if size == '11' || (op == '1' && size != '00') then UNDEFINED;
if Q == '1' && (Vd<0> == '1' || Vn<0> == '1' || Vm<0> == '1') then UNDEFINED;
polynomial = (op == '1'); long_destination = FALSE;
unsigned = FALSE; // "Don't care" value: TRUE produces same functionality
esize = 8 << UInt(size); elements = 64 DIV esize;
d = UInt(D:Vd); n = UInt(N:Vn); m = UInt(M:Vm); regs = if Q == '0' then 1 else 2;
    
```

Encoding T2 / A2 Advanced SIMD

VMULL<c>.<dt> <Qd>, <Dn>, <Dm>

15	14	13	12	11	10	9	8	7	6	5	4	3	2	1	0	15	14	13	12	11	10	9	8	7	6	5	4	3	2	1	0
1	1	1	U	1	1	1	1	1	D	size	Vn	Vd	1	1	op	0	N	0	M	0	Vm										
31	30	29	28	27	26	25	24	23	22	21	20	19	18	17	16	15	14	13	12	11	10	9	8	7	6	5	4	3	2	1	0
1	1	1	1	0	0	1	U	1	D	size	Vn	Vd	1	1	op	0	N	0	M	0	Vm										

```

if size == '11' then SEE "Related encodings";
if op == '1' && (U != '0' || size != '00') then UNDEFINED;
if Vd<0> == '1' then UNDEFINED;
polynomial = (op == '1'); long_destination = TRUE; unsigned = (U == '1');
esize = 8 << UInt(size); elements = 64 DIV esize;
d = UInt(D:Vd); n = UInt(N:Vn); m = UInt(M:Vm); regs = 1;
    
```

Related encodings See *Advanced SIMD data-processing instructions* on page A7-10

Assembler syntax

VMUL<c><q>.<type><size> {<Qd>}, <Qn>, <Qm>	Encoding T1 / A1. Q = 1
VMUL<c><q>.<type><size> {<Dd>}, <Dn>, <Dm>	Encoding T1 / A1. Q = 0
VMULL<c><q>.<type><size> <Qd>, <Dn>, <Dm>	Encoding T2 / A2

where:

<c><q>	See <i>Standard assembler syntax fields</i> on page A8-7. An ARM Advanced SIMD VMUL or VMULL instruction must be unconditional.
<type>	The data type for the elements of the operands. It must be one of: S op = 0 in both encodings. U = 0 in encoding T2 / A2 U op = 0 in both encodings. U = 1 in encoding T2 / A2 I op = 0 in encoding T1 / A1, not available in encoding T2 / A2 P op = 1 in both encodings. U = 0 in encoding T2 / A2. When <type> is P, <size> must be 8.
<size>	The data size for the elements of the operands. It must be one of: 8 encoded as size = 0b00 16 encoded as size = 0b01 32 encoded as size = 0b10.
<Qd>, <Qn>, <Qm>	The destination vector and the operand vectors, for a quadword operation.
<Dd>, <Dn>, <Dm>	The destination vector and the operand vectors, for a doubleword operation.
<Qd>, <Dn>, <Dm>	The destination vector and the operand vectors, for a long operation.

Operation

```

if ConditionPassed() then
    EncodingSpecificOperations(); CheckAdvSIMDEnabled();
    for r = 0 to regs-1
        for e = 0 to elements-1
            op1 = Elem[D[n+r],e,esize]; op1val = Int(op1, unsigned);
            op2 = Elem[D[m+r],e,esize]; op2val = Int(op2, unsigned);
            if polynomial then
                product = PolynomialMult(op1,op2);
            else
                product = (op1val*op2val)<2*esize-1:0>;
            if long_destination then
                Elem[Q[d>>1],e,2*esize] = product;
            else
                Elem[D[d+r],e,esize] = product<esize-1:0>;

```

Exceptions

Undefined Instruction.

A8.6.338 VMUL (floating-point)

Vector Multiply multiplies corresponding elements in two vectors, and places the results in the destination vector. Vector Multiply Long does the same thing, but with destination vector elements that are twice as long as the elements that are multiplied.

Encoding T1 / A1 Advanced SIMD (UNDEFINED in integer-only variant)

VMUL<c>.F32 <Qd>, <Qn>, <Qm>

VMUL<c>.F32 <Dd>, <Dn>, <Dm>

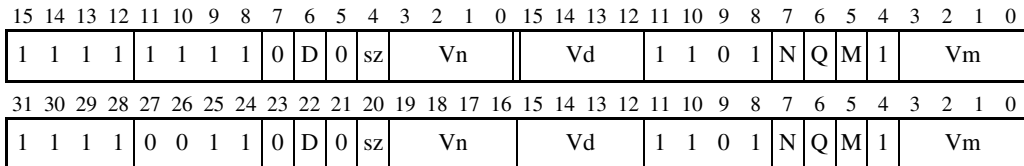

```

if Q == '1' && (Vd<0> == '1' || Vn<0> == '1' || Vm<0> == '1') then UNDEFINED;
if sz == '1' then UNDEFINED;
advsimd = TRUE;  esize = 32;  elements = 2;
d = UInt(D:Vd);  n = UInt(N:Vn);  m = UInt(M:Vm);  regs = if Q == '0' then 1 else 2;
    
```

Encoding T2 / A2 VFPv2, VFPv3 (sz = 1 UNDEFINED in single-precision only variants)

VMUL<c>.F64 <Dd>, <Dn>, <Dm>

VMUL<c>.F32 <Sd>, <Sn>, <Sm>

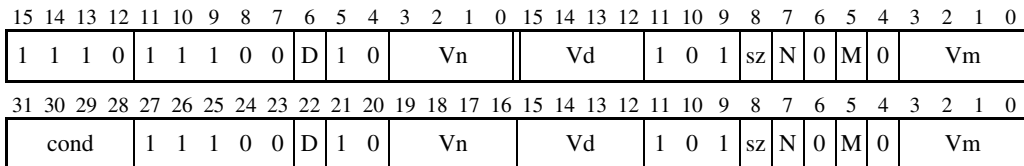

```

if FPSCR.LEN != '000' || FPSCR.STRIDE != '00' then SEE "VFP vectors";
advsimd = FALSE;  dp_operation = (sz == '1');
d = if dp_operation then UInt(D:Vd) else UInt(Vd:D);
n = if dp_operation then UInt(N:Vn) else UInt(Vn:N);
m = if dp_operation then UInt(M:Vm) else UInt(Vm:M);
    
```

VFP vectors Encoding T2 / A2 can operate on VFP vectors under control of the FPSCR.LEN and FPSCR.STRIDE bits. For details see Appendix F *VFP Vector Operation Support*.

Assembler syntax

VMUL<c><q>.F32 {<Qd>}, <Qn>, <Qm>	Encoding T1 / A1, Q = 1, sz = 0
VMUL<c><q>.F32 {<Dd>}, <Dn>, <Dm>	Encoding T1 / A1, Q = 0, sz = 0
VMUL<c><q>.F64 {<Dd>}, <Dn>, <Dm>	Encoding T2 / A2, sz = 1
VMUL<c><q>.F32 {<Sd>}, <Sn>, <Sm>	Encoding T2 / A2, sz = 0

where:

<c><q>	See <i>Standard assembler syntax fields</i> on page A8-7. An ARM Advanced SIMD VMUL instruction must be unconditional.
<Qd>, <Qn>, <Qm>	The destination vector and the operand vectors, for a quadword operation.
<Dd>, <Dn>, <Dm>	The destination vector and the operand vectors, for a doubleword operation.
<Sd>, <Sn>, <Sm>	The destination vector and the operand vectors, for a singleword operation.

Operation

```

if ConditionPassed() then
    EncodingSpecificOperations(); CheckAdvSIMDOrVFPEnabled(TRUE, advsimd);
    if advsimd then // Advanced SIMD instruction
        for r = 0 to regs-1
            for e = 0 to elements-1
                Elem[D[d+r],e,esize] = FPMu1(Elem[D[n+r],e,esize], Elem[D[m+r],e,esize], FALSE);
    else // VFP instruction
        if dp_operation then
            D[d] = FPMu1(D[n], D[m], TRUE);
        else
            S[d] = FPMu1(S[n], S[m], TRUE);

```

Exceptions

Undefined Instruction.

Floating-point exceptions: Input Denormal, Invalid Operation, Overflow, Underflow, and Inexact.

A8.6.339 VMUL, VMULL (by scalar)

Vector Multiply multiplies each element in a vector by a scalar, and places the results in a second vector. Vector Multiply Long does the same thing, but with destination vector elements that are twice as long as the elements that are multiplied.

For more information about scalars see *Advanced SIMD scalars* on page A7-9.

Encoding T1 / A1 Advanced SIMD (F = 1 UNDEFINED in integer-only variants)

VMUL<c>.<dt> <Qd>, <Qn>, <Dm[x]>

VMUL<c>.<dt> <Dd>, <Dn>, <Dm[x]>

15	14	13	12	11	10	9	8	7	6	5	4	3	2	1	0	15	14	13	12	11	10	9	8	7	6	5	4	3	2	1	0
1	1	1	Q	1	1	1	1	1	D	size	Vn				Vd				1	0	0	F	N	1	M	0	Vm				
31	30	29	28	27	26	25	24	23	22	21	20	19	18	17	16	15	14	13	12	11	10	9	8	7	6	5	4	3	2	1	0
1	1	1	1	0	0	1	Q	1	D	size	Vn				Vd				1	0	0	F	N	1	M	0	Vm				

```

if size == '11' then SEE "Related encodings";
if size == '00' || (F == '1' && size == '01') then UNDEFINED;
if Q == '1' && (Vd<0> == '1' || Vn<0> == '1') then UNDEFINED;
unsigned = FALSE; // "Don't care" value: TRUE produces same functionality
floating_point = (F == '1'); long_destination = FALSE;
d = UInt(D:Vd); n = UInt(N:Vn); regs = if Q == '0' then 1 else 2;
if size == '01' then esize = 16; elements = 4; m = UInt(Vm<2:0>); index = UInt(M:Vm<3>);
if size == '10' then esize = 32; elements = 2; m = UInt(Vm); index = UInt(M);
    
```

Encoding T2 / A2 Advanced SIMD

VMULL<c>.<dt> <Qd>, <Dn>, <Dm[x]>

15	14	13	12	11	10	9	8	7	6	5	4	3	2	1	0	15	14	13	12	11	10	9	8	7	6	5	4	3	2	1	0
1	1	1	U	1	1	1	1	1	D	size	Vn				Vd				1	0	1	0	N	1	M	0	Vm				
31	30	29	28	27	26	25	24	23	22	21	20	19	18	17	16	15	14	13	12	11	10	9	8	7	6	5	4	3	2	1	0
1	1	1	1	0	0	1	U	1	D	size	Vn				Vd				1	0	1	0	N	1	M	0	Vm				

```

if size == '11' then SEE "Related encodings";
if size == '00' || Vd<0> == '1' then UNDEFINED;
unsigned = (U == '1'); long_destination = TRUE; floating_point = FALSE;
d = UInt(D:Vd); n = UInt(N:Vn); regs = 1;
if size == '01' then esize = 16; elements = 4; m = UInt(Vm<2:0>); index = UInt(M:Vm<3>);
if size == '10' then esize = 32; elements = 2; m = UInt(Vm); index = UInt(M);
    
```

Related encodings See *Advanced SIMD data-processing instructions* on page A7-10

Assembler syntax

VMUL<c><q>.<dt> {<Qd>}, <Qn>, <Dm[x]>	Encoding T1 / A1, Q = 1
VMUL<c><q>.<dt> {<Dd>}, <Dn>, <Dm[x]>	Encoding T1 / A1, Q = 0
VMULL<c><q>.<dt> <Qd>, <Dn>, <Dm[x]>	Encoding T2 / A2

where:

<c><q>	See <i>Standard assembler syntax fields</i> on page A8-7. An ARM Advanced SIMD VMUL or VMULL instruction must be unconditional.
<dt>	The data type for the scalar, and the elements of the operand vector. It must be one of: <ul style="list-style-type: none"> I16 encoding T1 / A1, size = 0b01, F = 0 I32 encoding T1 / A1, size = 0b10, F = 0 F32 encoding T1 / A1, size = 0b10, F = 1 S16 encoding T2 / A2, size = 0b01, U = 0 S32 encoding T2 / A2, size = 0b10, U = 0 U16 encoding T2 / A2, size = 0b01, U = 1 U32 encoding T2 / A2, size = 0b10, U = 1.
<Qd>, <Qn>	The destination vector, and the operand vector, for a quadword operation.
<Dd>, <Dn>	The destination vector, and the operand vector, for a doubleword operation.
<Qd>, <Dn>	The destination vector, and the operand vector, for a long operation.
<Dm[x]>	The scalar. Dm is restricted to D0-D7 if <dt> is I16, S16, or U16, or D0-D15 otherwise.

Operation

```

if ConditionPassed() then
    EncodingSpecificOperations(); CheckAdvSIMDEnabled();
    op2 = Elem[D[m],index,esize]; op2val = Int(op2, unsigned);
    for r = 0 to regs-1
        for e = 0 to elements-1
            op1 = Elem[D[n+r],e,esize]; op1val = Int(op1, unsigned);
            if floating_point then
                Elem[D[d+r],e,esize] = FPMul(op1, op2, FALSE);
            else
                if long_destination then
                    Elem[Q[d>>1],e,2*esize] = (op1val*op2val)<2*esize-1:0>;
                else
                    Elem[D[d+r],e,esize] = (op1val*op2val)<esize-1:0>;

```

Exceptions

Undefined Instruction.

Floating-point exceptions: Input Denormal, Invalid Operation, Overflow, Underflow, and Inexact.

A8.6.340 VMVN (immediate)

Vector Bitwise NOT (immediate) places the bitwise inverse of an immediate integer constant into every element of the destination register. For the range of constants available, see *One register and a modified immediate value* on page A7-21.

Encoding T1 / A1 Advanced SIMD

VMVN<c>.<dt> <Qd>, #<imm>

VMVN<c>.<dt> <Dd>, #<imm>

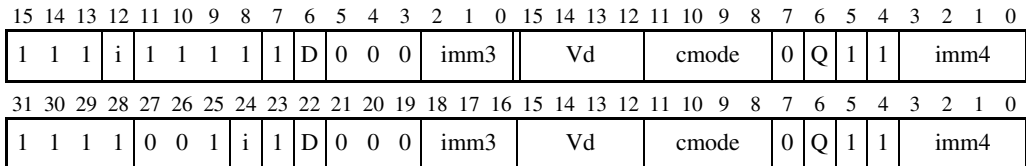

```

if (cmode<0> == '1' && cmode<3:2> != '11') || cmode<3:1> == '111' then SEE "Related encodings";
if Q == '1' && Vd<0> == '1' then UNDEFINED;
imm64 = AdvSIMDExpandImm('1', cmode, i:imm3:imm4);
d = UInt(D:Vd); regs = if Q == '0' then 1 else 2;
    
```

Related encodings See *One register and a modified immediate value* on page A7-21

Assembler syntax

VMVN<c><q>.dt <Qd>, #<imm> Encoding T1 / A1, Q = 1
 VMVN<c><q>.dt <Dd>, #<imm> Encoding T1 / A1, Q = 0

where:

<c><q> See *Standard assembler syntax fields* on page A8-7. An ARM VMVN instruction must be unconditional.

<dt> The data type. It must be either I16 or I32.

<Qd> The destination register for a quadword operation.

<Dd> The destination register for a doubleword operation.

<imm> A constant of the specified type.

See *One register and a modified immediate value* on page A7-21 for the range of constants available, and the encoding of <dt> and <imm>.

Operation

```
if ConditionPassed() then
    EncodingSpecificOperations(); CheckAdvSIMDEnabled();
    for r = 0 to regs-1
        D[d+r] = NOT(imm64);
```

Exceptions

Undefined Instruction.

Pseudo-instructions

One register and a modified immediate value on page A7-21 describes pseudo-instructions with a combination of <dt> and <imm> that is not supported by hardware, but that generates the same destination register value as a different combination that is supported by hardware.

A8.6.341 VMVN (register)

Vector Bitwise NOT (register) takes a value from a register, inverts the value of each bit, and places the result in the destination register. The registers can be either doubleword or quadword.

Encoding T1 / A1 Advanced SIMD

VMVN<C> <Qd>, <Qm>

VMVN<C> <Dd>, <Dm>

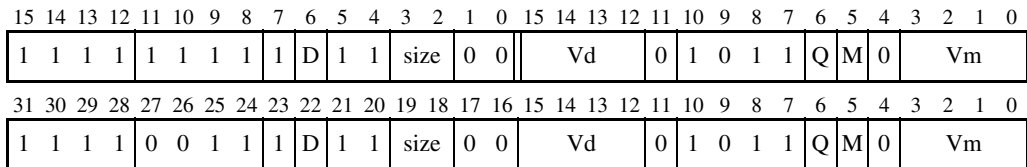

```

if size != '00' then UNDEFINED;
if Q == '1' && (Vd<0> == '1' || Vm<0> == '1') then UNDEFINED;
d = UInt(D:Vd); m = UInt(M:Vm); regs = if Q == '0' then 1 else 2;
    
```

Assembler syntax

VMVN<c><q>{.<dt>} <Qd>, <Qm>

VMVN<c><q>{.<dt>} <Dd>, <Dm>

where:

<c><q> See *Standard assembler syntax fields* on page A8-7. An ARM VMVN instruction must be unconditional.

<dt> An optional data type. It is ignored by assemblers, and does not affect the encoding.

<Qd>, <Qm> The destination vector and the operand vector, for a quadword operation.

<Dd>, <Dm> The destination vector and the operand vector, for a doubleword operation.

Operation

```
if ConditionPassed() then
    EncodingSpecificOperations(); CheckAdvSIMDEnabled();
    for r = 0 to regs-1
        D[d+r] = NOT(D[m+r]);
```

Exceptions

Undefined Instruction.

A8.6.342 VNEG

Vector Negate negates each element in a vector, and places the results in a second vector. The floating-point version only inverts the sign bit.

Encoding T1 / A1 Advanced SIMD (F = 1 UNDEFINED in integer-only variants)

VNEG<c>.<dt> <Qd>, <Qm>

VNEG<c>.<dt> <Dd>, <Dm>

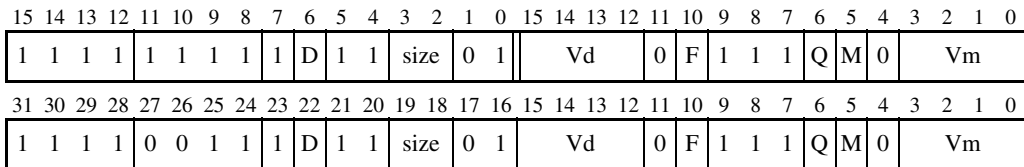

```

if size == '11' || (F == '1' && size != '10') then UNDEFINED;
if Q == '1' && (Vd<0> == '1' || Vm<0> == '1') then UNDEFINED;
advsimd = TRUE; floating_point = (F == '1');
esize = 8 << UInt(size); elements = 64 DIV esize;
d = UInt(D:Vd); m = UInt(M:Vm); regs = if Q == '0' then 1 else 2;
    
```

Encoding T2 / A2 VFPv2, VFPv3 (sz = 1 UNDEFINED in single-precision only variants)

VNEG<c>.F64 <Dd>, <Dm>

VNEG<c>.F32 <Sd>, <Sm>

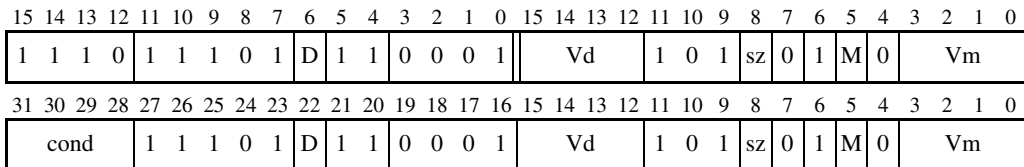

```

if FPSCR.LEN != '000' || FPSCR.STRIDE != '00' then SEE "VFP vectors";
advsimd = FALSE; dp_operation = (sz == '1');
d = if dp_operation then UInt(D:Vd) else UInt(Vd:D);
m = if dp_operation then UInt(M:Vm) else UInt(Vm:M);
    
```

VFP vectors Encoding T2 / A2 can operate on VFP vectors under control of the FPSCR.LEN and FPSCR.STRIDE bits. For details see Appendix F *VFP Vector Operation Support*.

Assembler syntax

```
VNEG<c><q>.<dt> <Qd>, <Qm>                                <dt> != F64
VNEG<c><q>.<dt> <Dd>, <Dm>
VNEG<c><q>.<F32> <Sd>, <Sm>                                VFP only, encoding T2/A2, sz = 0
```

where:

<c><q> See *Standard assembler syntax fields* on page A8-7. An ARM Advanced SIMD VNEG instruction must be unconditional.

<dt> The data type for the elements of the vectors. It must be one of:

S8	encoding T1 / A1, size = 0b00, F = 0
S16	encoding T1 / A1, size = 0b01, F = 0
S32	encoding T1 / A1, size = 0b10, F = 0
F32	encoding T1 / A1, size = 0b10, F = 1
F64	encoding T2 / A2, sz = 1.

<Qd>, <Qm> The destination vector and the operand vector, for a quadword operation.

<Dd>, <Dm> The destination vector and the operand vector, for a doubleword operation.

<Sd>, <Sm> The destination vector and the operand vector, for a singleword operation.

Operation

```
if ConditionPassed() then
    EncodingSpecificOperations(); CheckAdvSIMDorVFPEEnabled(TRUE, advsimd);
    if advsimd then // Advanced SIMD instruction
        for r = 0 to regs-1
            for e = 0 to elements-1
                if floating_point then
                    Elem[D[d+r],e,esize] = FPNeg(Elem[D[m+r],e,esize]);
                else
                    result = -SInt(Elem[D[m+r],e,esize]);
                    Elem[D[d+r],e,esize] = result<size-1:0>;
    else // VFP instruction
        if dp_operation then
            D[d] = FPNeg(D[m]);
        else
            S[d] = FPNeg(S[m]);
```

Exceptions

Undefined Instruction.

A8.6.343 VNMLA, VNMLS, VNMUL

VNMLA multiplies together two floating-point register values, adds the negation of the floating-point value in the destination register to the negation of the product, and writes the result back to the destination register.

VNMLS multiplies together two floating-point register values, adds the negation of the floating-point value in the destination register to the product, and writes the result back to the destination register.

VNMUL multiplies together two floating-point register values, and writes the negation of the result to the destination register.

Encoding T1 / A1 VFPv2, VFPv3 (sz = 1 UNDEFINED in single-precision only variants)

VNMLA<c>.F64 <Dd>, <Dn>, <Dm>

VNMLA<c>.F32 <Sd>, <Sn>, <Sm>

VNMLS<c>.F64 <Dd>, <Dn>, <Dm>

VNMLS<c>.F32 <Sd>, <Sn>, <Sm>

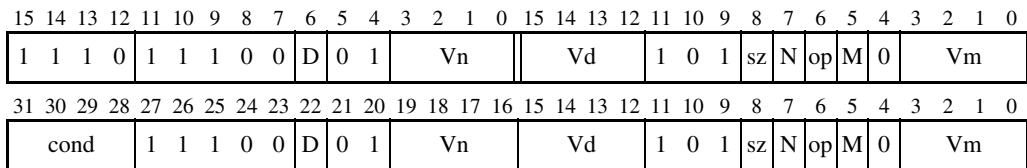

if FPSCR.LEN != '000' || FPSCR.STRIDE != '00' then SEE "VFP vectors";

type = if op == '1' then VFPNegMul_VNMLA else VFPNegMul_VNMLS;

dp_operation = (sz == '1');

d = if dp_operation then UInt(D:Vd) else UInt(Vd:D);

n = if dp_operation then UInt(N:Vn) else UInt(Vn:N);

m = if dp_operation then UInt(M:Vm) else UInt(Vm:M);

Encoding T2 / A2 VFPv2, VFPv3 (sz = 1 UNDEFINED in single-precision only variants)

VNMUL<c>.F64 <Dd>, <Dn>, <Dm>

VNMUL<c>.F32 <Sd>, <Sn>, <Sm>

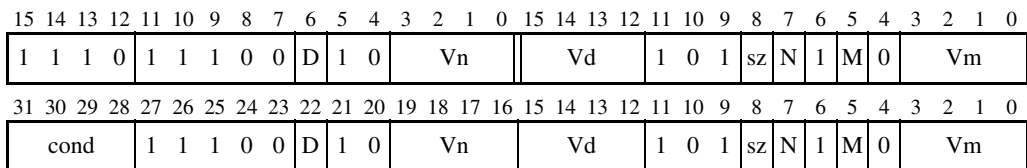

if FPSCR.LEN != '000' || FPSCR.STRIDE != '00' then SEE "VFP vectors";

type = VFPNegMul_VNMUL;

dp_operation = (sz == '1');

d = if dp_operation then UInt(D:Vd) else UInt(Vd:D);

n = if dp_operation then UInt(N:Vn) else UInt(Vn:N);

m = if dp_operation then UInt(M:Vm) else UInt(Vm:M);

VFP vectors

These instructions can operate on VFP vectors under control of the FPSCR.LEN and FPSCR.STRIDE bits. For details see Appendix F *VFP Vector Operation Support*.

Assembler syntax

VN<op><C><q>.F64 <Dd>, <Dn>, <Dm>	Encoding T1 / A1 with sz = 1
VN<op><C><q>.F32 <Sd>, <Sn>, <Sm>	Encoding T1 / A1 with sz = 0
VNMUL<C><q>.F64 {<Dd>}, <Dn>, <Dm>	Encoding T2 / A2 with sz = 1
VNMUL<C><q>.F32 {<Sd>}, <Sn>, <Sm>	Encoding T2 / A2 with sz = 0

where:

<C><q>	See <i>Standard assembler syntax fields</i> on page A8-7.
<op>	Must be one of: MLA op = 1 MLS op = 0.
<Dd>, <Dn>, <Dm>	The destination register and the operand registers, for a double-precision operation.
<Sd>, <Sn>, <Sm>	The destination register and the operand registers, for a single-precision operation.

Operation

```
enumeration VFPNegMul {VFPNegMul_VNMLA, VFPNegMul_VNMLS, VFPNegMul_VNMUL};
```

```
if ConditionPassed() then
    EncodingSpecificOperations(); CheckVFPEabled(TRUE);
    if dp_operation then
        product = FPMul(D[n], D[m], TRUE);
        case type of
            when VFPNegMul_VNMLA D[d] = FPAdd(FPNeg(D[d]), FPNeg(product), TRUE);
            when VFPNegMul_VNMLS D[d] = FPAdd(FPNeg(D[d]), product, TRUE);
            when VFPNegMul_VNMUL D[d] = FPNeg(product);
        else
            product = FPMul(S[n], S[m], TRUE);
            case type of
                when VFPNegMul_VNMLA S[d] = FPAdd(FPNeg(S[d]), FPNeg(product), TRUE);
                when VFPNegMul_VNMLS S[d] = FPAdd(FPNeg(S[d]), product, TRUE);
                when VFPNegMul_VNMUL S[d] = FPNeg(product);
```

Exceptions

Undefined Instruction.

Floating-point exceptions: Invalid Operation, Overflow, Underflow, Inexact, Input Denormal.

A8.6.344 VORN (immediate)

VORN (immediate) is a pseudo-instruction, equivalent to a VORR (immediate) instruction with the immediate value bitwise inverted. For details see *VORR (immediate)* on page A8-678.

A8.6.345 VORN (register)

This instruction performs a bitwise OR NOT operation between two registers, and places the result in the destination register. The operand and result registers can be quadword or doubleword. They must all be the same size.

Encoding T1 / A1 Advanced SIMD

VORN<c> <Qd>, <Qn>, <Qm>

VORN<c> <Dd>, <Dn>, <Dm>

15	14	13	12	11	10	9	8	7	6	5	4	3	2	1	0	15	14	13	12	11	10	9	8	7	6	5	4	3	2	1	0
1	1	1	0	1	1	1	1	0	D	1	1	Vn				Vd				0	0	0	1	N	Q	M	1	Vm			
31	30	29	28	27	26	25	24	23	22	21	20	19	18	17	16	15	14	13	12	11	10	9	8	7	6	5	4	3	2	1	0
1	1	1	1	0	0	1	0	0	D	1	1	Vn				Vd				0	0	0	1	N	Q	M	1	Vm			

```
if Q == '1' && (Vd<0> == '1' || Vn<0> == '1' || Vm<0> == '1') then UNDEFINED;
d = UInt(D:Vd); n = UInt(N:Vn); m = UInt(M:Vm); regs = if Q == '0' then 1 else 2;
```

Assembler syntax

VORN<c><q>{.<dt>} {<Qd>}, <Qn>, <Qm>	Encoded as Q = 1
VORN<c><q>{.<dt>} {<Dd>}, <Dn>, <Dm>	Encoded as Q = 0

where:

<c><q>	See <i>Standard assembler syntax fields</i> on page A8-7. An ARM VORN instruction must be unconditional.
<dt>	An optional data type. It is ignored by assemblers, and does not affect the encoding.
<Qd>, <Qn>, <Qm>	The destination vector and the operand vectors, for a quadword operation.
<Dd>, <Dn>, <Dm>	The destination vector and the operand vectors, for a doubleword operation.

Operation

```

if ConditionPassed() then
    EncodingSpecificOperations(); CheckAdvSIMDEnabled();
    for r = 0 to regs-1
        D[d+r] = D[n+r] OR NOT(D[m+r]);

```

Exceptions

Undefined Instruction.

A8.6.346 VORR (immediate)

This instruction takes the contents of the destination vector, performs a bitwise OR with an immediate constant, and returns the result into the destination vector. For the range of constants available, see *One register and a modified immediate value* on page A7-21.

Encoding T1 / A1 Advanced SIMD

VORR<c>.<dt> <Qd>, #<imm>

VORR<c>.<dt> <Dd>, #<imm>

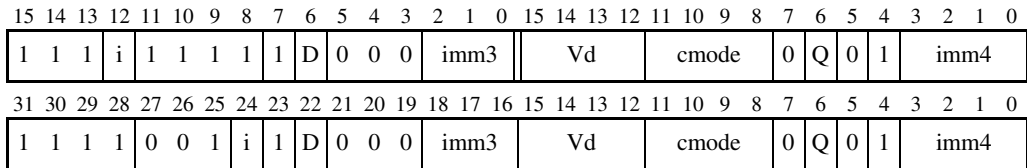

```

if cmode<0> == '0' || cmode<3:2> == '11' then SEE VMOV (immediate);
if Q == '1' && Vd<0> == '1' then UNDEFINED;
imm64 = AdvSIMDExpandImm('0', cmode, i:imm3:imm4);
d = UInt(D:Vd); regs = if Q == '0' then 1 else 2;
    
```

Assembler syntax

VORR<c><q>.<dt> {<Qd>}, <Qd>, #<imm> Encoded as Q = 1
 VORR<c><q>.<dt> {<Dd>}, <Dd>, #<imm>> Encoded as Q = 0

where:

<c><q> See *Standard assembler syntax fields* on page A8-7. An ARM VORR instruction must be unconditional.

<dt> The data type used for <imm>. It can be either I16 or I32.
 I8, I64, and F32 are also permitted, but the resulting syntax is a pseudo-instruction.

<Qd> The destination vector for a quadword operation.

<Dd> The destination vector for a doubleword operation.

<imm> A constant of the type specified by <dt>. This constant is replicated enough times to fill the destination register. For example, VORR.I32 D0,#10 ORs 0x0000000A0000000A into D0.

For details of the range of constants available, and the encoding of <dt> and <imm>, see *One register and a modified immediate value* on page A7-21.

Operation

```
if ConditionPassed() then
    EncodingSpecificOperations(); CheckAdvSIMDEnabled();
    for r = 0 to regs-1
        D[d+r] = D[d+r] OR imm64;
```

Exceptions

Undefined Instruction.

Pseudo-instructions

VORN can be used, with a range of constants that are the bitwise inverse of the available constants for VORR. This is assembled as the equivalent VORR instruction. Disassembly produces the VORR form.

One register and a modified immediate value on page A7-21 describes pseudo-instructions with a combination of <dt> and <imm> that is not supported by hardware, but that generates the same destination register value as a different combination that is supported by hardware.

A8.6.347 VORR (register)

This instruction performs a bitwise OR operation between two registers, and places the result in the destination register. The operand and result registers can be quadword or doubleword. They must all be the same size.

Encoding T1 / A1 Advanced SIMD

VORR<c> <Qd>, <Qn>, <Qm>

VORR<c> <Dd>, <Dn>, <Dm>

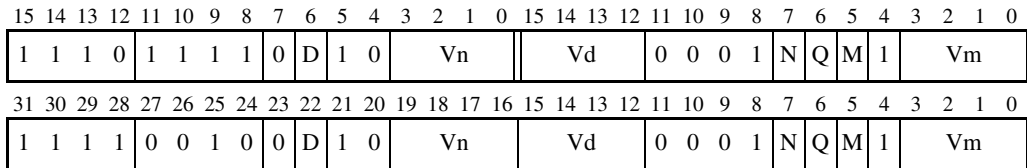

```

if N == M && Vn == Vm then SEE VMOV (register);
if Q == '1' && (Vd<0> == '1' || Vn<0> == '1' || Vm<0> == '1') then UNDEFINED;
d = UInt(D:Vd); n = UInt(N:Vn); m = UInt(M:Vm); regs = if Q == '0' then 1 else 2;
    
```

Assembler syntax

VORR<c><q>{.<dt>} {<Qd>,<Qn>,<Qm>}	Encoded as Q = 1
VORR<c><q>{.<dt>} {<Dd>,<Dn>,<Dm>}	Encoded as Q = 0

where:

<c><q>	See <i>Standard assembler syntax fields</i> on page A8-7. An ARM VORR instruction must be unconditional.
<dt>	An optional data type. It is ignored by assemblers, and does not affect the encoding.
<Qd>, <Qn>, <Qm>	The destination vector and the operand vectors, for a quadword operation.
<Dd>, <Dn>, <Dm>	The destination vector and the operand vectors, for a doubleword operation.

Operation

```

if ConditionPassed() then
    EncodingSpecificOperations(); CheckAdvSIMDEnabled();
    for r = 0 to regs-1
        D[d+r] = D[n+r] OR D[m+r];

```

Exceptions

Undefined Instruction.

A8.6.348 VPADAL

Vector Pairwise Add and Accumulate Long adds adjacent pairs of elements of a vector, and accumulates the ~~absolute values of the~~ results into the elements of the destination vector.

The vectors can be doubleword or quadword. The operand elements can be 8-bit, 16-bit, or 32-bit integers. The result elements are twice the length of the operand elements.

Figure A8-2 shows an example of the operation of VPADAL.

Encoding T1 / A1 Advanced SIMD

VPADAL<c>.<dt> <Qd>, <Qm>

VPADAL<c>.<dt> <Dd>, <Dm>

15	14	13	12	11	10	9	8	7	6	5	4	3	2	1	0	15	14	13	12	11	10	9	8	7	6	5	4	3	2	1	0
1	1	1	1	1	1	1	1	D	1	1	size	0	0	Vd	0	1	1	0	op	Q	M	0	Vm								
31	30	29	28	27	26	25	24	23	22	21	20	19	18	17	16	15	14	13	12	11	10	9	8	7	6	5	4	3	2	1	0
1	1	1	1	0	0	1	1	1	D	1	1	size	0	0	Vd	0	1	1	0	op	Q	M	0	Vm							

```

if size == '11' then UNDEFINED;
if Q == '1' && (Vd<0> == '1' || Vm<0> == '1') then UNDEFINED;
unsigned = (op == '1');
esize = 8 << UInt(size);  elements = 64 DIV esize;
d = UInt(D:Vd);  m = UInt(M:Vm);  regs = if Q == '0' then 1 else 2;
    
```

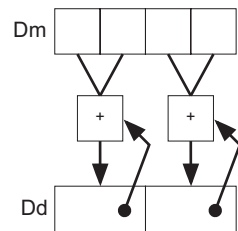

Figure A8-2 Operation of doubleword VPADAL for data type S16

Assembler syntax

VPADAL<C><q>.<dt> <Qd>, <Qm> Encoded as Q = 1
 VPADAL<C><q>.<dt> <Dd>, <Dm> Encoded as Q = 0

where:

<C><q> See *Standard assembler syntax fields* on page A8-7. An ARM VPADAL instruction must be unconditional.

<dt> The data type for the elements of the vectors. It must be one of:

S8	encoded as size = 0b00, op = 0
S16	encoded as size = 0b01, op = 0
S32	encoded as size = 0b10, op = 0
U8	encoded as size = 0b00, op = 1
U16	encoded as size = 0b01, op = 1
U32	encoded as size = 0b10, op = 1.

<Qd>, <Qm> The destination vector and the operand vector, for a quadword operation.

<Dd>, <Dm> The destination vector and the operand vector, for a doubleword operation.

Operation

```
if ConditionPassed() then
    EncodingSpecificOperations(); CheckAdvSIMDEnabled();
    h = elements/2;

    for r = 0 to regs-1
        for e = 0 to h-1
            op1 = Elem[D[m+r],2*e,esize]; op2 = Elem[D[m+r],2*e+1,esize];
            result = Int(op1, unsigned) + Int(op2, unsigned);
            Elem[D[d+r],e,2*esize] = Elem[D[d+r],e,2*esize] + result;
```

Exceptions

Undefined Instruction.

A8.6.349 VPADD (integer)

Vector Pairwise Add (integer) adds adjacent pairs of elements of two vectors, and places the results in the destination vector.

The operands and result are doubleword vectors.

The operand and result elements must all be the same type, and can be 8-bit, 16-bit, or 32-bit integers. There is no distinction between signed and unsigned integers.

Figure A8-3 shows an example of the operation of VPADD.

Encoding T1 / A1 Advanced SIMD

VPADD<c>.<dt> <Dd>, <Dn>, <Dm>

15	14	13	12	11	10	9	8	7	6	5	4	3	2	1	0	15	14	13	12	11	10	9	8	7	6	5	4	3	2	1	0
1	1	1	0	1	1	1	1	0	D	size	Vn				Vd				1	0	1	1	N	Q	M	1	Vm				
31	30	29	28	27	26	25	24	23	22	21	20	19	18	17	16	15	14	13	12	11	10	9	8	7	6	5	4	3	2	1	0
1	1	1	1	0	0	1	0	0	D	size	Vn				Vd				1	0	1	1	N	Q	M	1	Vm				

```

if size == '11' || Q == '1' then UNDEFINED;
esize = 8 << UInt(size);  elements = 64 DIV esize;
d = UInt(D:Vd);  n = UInt(N:Vn);  m = UInt(M:Vm);
    
```

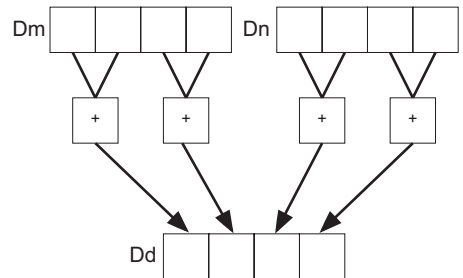

Figure A8-3 Operation of VPADD for data type I16

Assembler syntax

VPADD<c><q>.<dt> {<Dd>,<Dn>,<Dm>} Encoded as Q = 0

where:

<c><q> See *Standard assembler syntax fields* on page A8-7. An ARM VPADD instruction must be unconditional.

<dt> The data type for the elements of the vectors. It must be one of:

I8 encoding T1 / A1, size = 0b00

I16 encoding T1 / A1, size = 0b01

I32 encoding T1 / A1, size = 0b10.

<Dd>, <Dn>, <Dm> The destination vector, the first operand vector, and the second operand vector.

Operation

```

if ConditionPassed() then
    EncodingSpecificOperations(); CheckAdvSIMDEnabled();
    bits(64) dest;
    h = elements/2;

    for e = 0 to h-1
        Elem[dest,e,esize] = Elem[D[n],2*e,esize] + Elem[D[n],2*e+1,esize];
        Elem[dest,e+h,esize] = Elem[D[m],2*e,esize] + Elem[D[m],2*e+1,esize];

    D[d] = dest;

```

Exceptions

Undefined Instruction.

A8.6.350 VPADD (floating-point)

Vector Pairwise Add (floating-point) adds adjacent pairs of elements of two vectors, and places the results in the destination vector.

The operands and result are doubleword vectors.

The operand and result elements are 32-bit floating-point numbers.

Figure A8-3 on page A8-684 shows an example of the operation of VPADD.

Encoding T1 / A1 Advanced SIMD (UNDEFINED in integer-only variant)

VPADD<c>.*F32* <Dd>, <Dn>, <Dm>

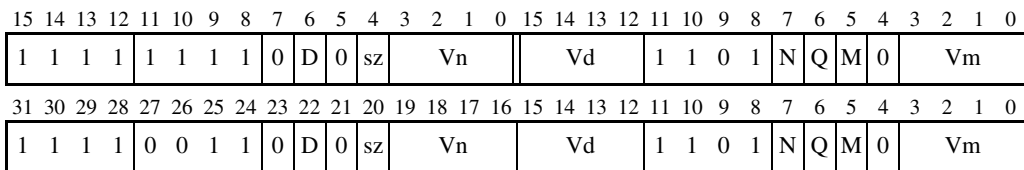

```

if sz == '1' || Q == '1' then UNDEFINED;
esize = 32; elements = 2;
d = UInt(D:Vd); n = UInt(N:Vn); m = UInt(M:Vm);
    
```

Assembler syntax

VPADD<c><q>.F32 {<Dd>,<Dn>,<Dm>

Encoded as Q = 0, sz = 0

where:

<c><q> See *Standard assembler syntax fields* on page A8-7. An ARM VPADD instruction must be unconditional.

<Dd>, <Dn>, <Dm> The destination vector, the first operand vector, and the second operand vector.

Operation

```

if ConditionPassed() then
    EncodingSpecificOperations(); CheckAdvSIMDEnabled();
    bits(64) dest;
    h = elements/2;

    for e = 0 to h-1
        Elem[dest,e,esize] = FPAAdd(Elem[D[n],2*e,esize], Elem[D[n],2*e+1,esize], FALSE);
        Elem[dest,e+h,esize] = FPAAdd(Elem[D[m],2*e,esize], Elem[D[m],2*e+1,esize], FALSE);

    D[d] = dest;

```

Exceptions

Undefined Instruction.

Floating-point exceptions: Input Denormal, Invalid Operation, Overflow, Underflow, and Inexact.

A8.6.351 VPADDL

Vector Pairwise Add Long adds adjacent pairs of elements of two vectors, and places the results in the destination vector.

The vectors can be doubleword or quadword. The operand elements can be 8-bit, 16-bit, or 32-bit integers. The result elements are twice the length of the operand elements.

Figure A8-4 shows an example of the operation of VPADDL.

Encoding T1 / A1 Advanced SIMD

VPADDL<c>.<dt> <Qd>, <Qm>

VPADDL<c>.<dt> <Dd>, <Dm>

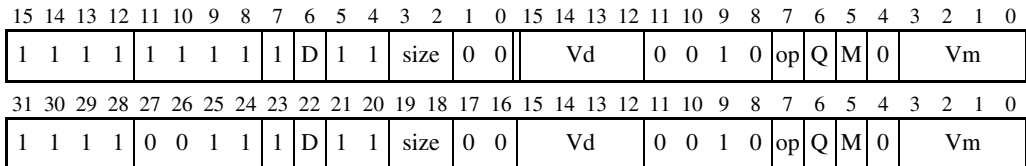

```

if size == '11' then UNDEFINED;
if Q == '1' && (Vd<0> == '1' || Vm<0> == '1') then UNDEFINED;
unsigned = (op == '1');
esize = 8 << UInt(size); elements = 64 DIV esize;
d = UInt(D:Vd); m = UInt(M:Vm); regs = if Q == '0' then 1 else 2;
    
```

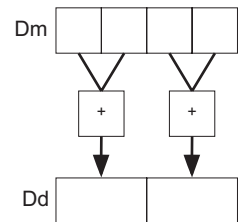

Figure A8-4 Operation of doubleword VPADDL for data type S16

Assembler syntax

VPADDL<C><Q>.<dt> <Qd>, <Qm> Encoded as Q = 1
 VPADDL<C><Q>.<dt> <Dd>, <Dm> Encoded as Q = 0

where:

<C><Q> See *Standard assembler syntax fields* on page A8-7. An ARM VPADDL instruction must be unconditional.

<dt> The data type for the elements of the vectors. It must be one of:

S8	encoded as size = 0b00, op = 0
S16	encoded as size = 0b01, op = 0
S32	encoded as size = 0b10, op = 0
U8	encoded as size = 0b00, op = 1
U16	encoded as size = 0b01, op = 1
U32	encoded as size = 0b10, op = 1.

<Qd>, <Qm> The destination vector and the operand vector, for a quadword operation.

<Dd>, <Dm> The destination vector and the operand vector, for a doubleword operation.

Operation

```

if ConditionPassed() then
    EncodingSpecificOperations(); CheckAdvSIMDEnabled();
    h = elements/2;

    for r = 0 to regs-1
        for e = 0 to h-1
            op1 = Elem[D[m+r],2*e,esize]; op2 = Elem[D[m+r],2*e+1,esize];
            result = Int(op1, unsigned) + Int(op2, unsigned);
            Elem[D[d+r],e,2*esize] = result<2*esize-1:0>;
  
```

Exceptions

Undefined Instruction.

A8.6.352 VPMAX, VPMIN (integer)

Vector Pairwise Maximum compares adjacent pairs of elements in two doubleword vectors, and copies the larger of each pair into the corresponding element in the destination doubleword vector.

Vector Pairwise Minimum compares adjacent pairs of elements in two doubleword vectors, and copies the smaller of each pair into the corresponding element in the destination doubleword vector.

Figure A8-5 shows an example of the operation of VPMAX.

Encoding T1 / A1 Advanced SIMD

VP<op><c>.<dt> <Dd>, <Dn>, <Dm>

15	14	13	12	11	10	9	8	7	6	5	4	3	2	1	0	15	14	13	12	11	10	9	8	7	6	5	4	3	2	1	0
1	1	1	U	1	1	1	1	0	D	size	Vn	Vd				1	0	1	0	N	Q	M	op	Vm							
31	30	29	28	27	26	25	24	23	22	21	20	19	18	17	16	15	14	13	12	11	10	9	8	7	6	5	4	3	2	1	0
1	1	1	1	0	0	1	U	0	D	size	Vn	Vd				1	0	1	0	N	Q	M	op	Vm							

```

if size == '11' || Q == '1' then UNDEFINED;
maximum = (op == '0'); unsigned = (U == '1');
esize = 8 << UInt(size); elements = 64 DIV esize;
d = UInt(D:Vd); n = UInt(N:Vn); m = UInt(M:Vm);
    
```

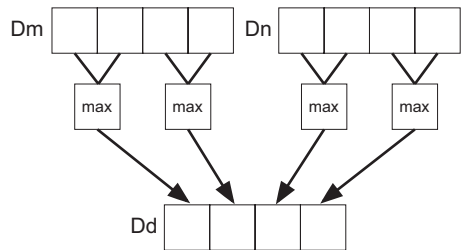

Figure A8-5 Operation of VPMAX for data type S16 or U16

Assembler syntax

VP<op><c><q>.<dt> {<Dd>,<Dn>,<Dm>} Encoded as Q = 0

where:

<op>	Must be one of: MAX encoded as op = 0 MIN encoded as op = 1.
<c><q>	See <i>Standard assembler syntax fields</i> on page A8-7. An ARM VPMAX or VPMIN instruction must be unconditional.
<dt>	The data type for the elements of the vectors. It must be one of: S8 encoding T1 / A1, size = 0b00, U = 0 S16 encoding T1 / A1, size = 0b01, U = 0 S32 encoding T1 / A1, size = 0b10, U = 0 U8 encoding T1 / A1, size = 0b00, U = 1 U16 encoding T1 / A1, size = 0b01, U = 1 U32 encoding T1 / A1, size = 0b10, U = 1.
<Dd>,<Dn>,<Dm>	The destination vector and the operand vectors.

Operation

```

if ConditionPassed() then
    EncodingSpecificOperations(); CheckAdvSIMDEnabled();
    bits(64) dest;
    h = elements/2;

    for e = 0 to h-1
        op1 = Int(Elem[D[n],2*e,esize], unsigned);
        op2 = Int(Elem[D[n],2*e+1,esize], unsigned);
        result = if maximum then Max(op1,op2) else Min(op1,op2);
        Elem[dest,e,esize] = result<esize-1:0>;
        op1 = Int(Elem[D[m],2*e,esize], unsigned);
        op2 = Int(Elem[D[m],2*e+1,esize], unsigned);
        result = if maximum then Max(op1,op2) else Min(op1,op2);
        Elem[dest,e+h,esize] = result<esize-1:0>;

    D[d] = dest;

```

Exceptions

Undefined Instruction.

A8.6.353 VPMAX, VPMIN (floating-point)

Vector Pairwise Maximum compares adjacent pairs of elements in two doubleword vectors, and copies the larger of each pair into the corresponding element in the destination doubleword vector.

Vector Pairwise Minimum compares adjacent pairs of elements in two doubleword vectors, and copies the smaller of each pair into the corresponding element in the destination doubleword vector.

Figure A8-5 on page A8-690 shows an example of the operation of VPMAX.

Encoding T1 / A1 Advanced SIMD (UNDEFINED in integer-only variant)

VP<op><c>.F32 <Dd>, <Dn>, <Dm>

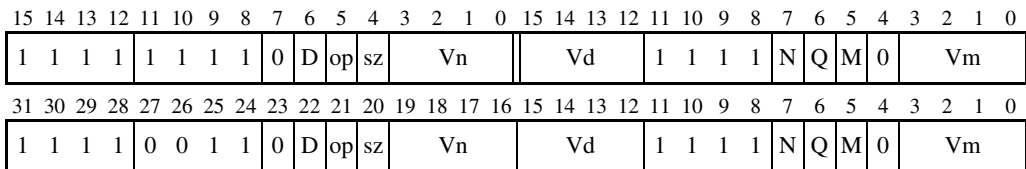

```

if sz == '1' || Q == '1' then UNDEFINED;
maximum = (op == '0'); esize = 32; elements = 2;
d = UInt(D:Vd); n = UInt(N:Vn); m = UInt(M:Vm);
    
```

Assembler syntax

VP<op><c><q>.F32 {<Dd>,<Dn>,<Dm>} Encoded as Q = 0, sz = 0

where:

<op>	Must be one of: MAX encoded as op = 0 MIN encoded as op = 1.
<c><q>	See <i>Standard assembler syntax fields</i> on page A8-7. An ARM VPMAX or VPMIN instruction must be unconditional.
<Dd>,<Dn>,<Dm>	The destination vector and the operand vectors.

Operation

```

if ConditionPassed() then
    EncodingSpecificOperations(); CheckAdvSIMDEnabled();
    bits(64) dest;
    h = elements/2;

    for e = 0 to h-1
        op1 = Elem[D[n],2*e,esize]; op2 = Elem[D[n],2*e+1,esize];
        Elem[dest,e,esize] = if maximum then FPMax(op1,op2,FALSE) else FPMIn(op1,op2,FALSE);
        op1 = Elem[D[m],2*e,esize]; op2 = Elem[D[m],2*e+1,esize];
        Elem[dest,e+h,esize] = if maximum then FPMax(op1,op2,FALSE) else FPMIn(op1,op2,FALSE);

    D[d] = dest;

```

Exceptions

Undefined Instruction.

A8.6.354 VPOP

Vector Pop loads multiple consecutive extension registers from the stack.

Encoding T1 / A1 VFPv2, VFPv3, Advanced SIMD

VPOP <list> <list> is consecutive 64-bit registers

15	14	13	12	11	10	9	8	7	6	5	4	3	2	1	0	15	14	13	12	11	10	9	8	7	6	5	4	3	2	1	0
1	1	1	0	1	1	0	0	1	D	1	1	1	1	0	1	Vd	1	0	1	1	imm8										
31	30	29	28	27	26	25	24	23	22	21	20	19	18	17	16	15	14	13	12	11	10	9	8	7	6	5	4	3	2	1	0
cond		1	1	0	0	1	D	1	1	1	1	0	1	Vd	1	0	1	1	imm8												

```
single_regs = FALSE; d = UInt(D:Vd); imm32 = ZeroExtend(imm8:'00', 32);
regs = UInt(imm8) DIV 2; // If UInt(imm8) is odd, see "FLDMX".
if regs == 0 || regs > 16 || (d+regs) > 32 then UNPREDICTABLE;
```

Encoding T2 / A2 VFPv2, VFPv3

VPOP <list> <list> is consecutive 32-bit registers

15	14	13	12	11	10	9	8	7	6	5	4	3	2	1	0	15	14	13	12	11	10	9	8	7	6	5	4	3	2	1	0
1	1	1	0	1	1	0	0	1	D	1	1	1	1	0	1	Vd	1	0	1	0	imm8										
31	30	29	28	27	26	25	24	23	22	21	20	19	18	17	16	15	14	13	12	11	10	9	8	7	6	5	4	3	2	1	0
cond		1	1	0	0	1	D	1	1	1	1	0	1	Vd	1	0	1	0	imm8												

```
single_regs = TRUE; d = UInt(Vd:D);
imm32 = ZeroExtend(imm8:'00', 32); regs = UInt(imm8);
if regs == 0 || regs > 16 || (d+regs) > 32 then UNPREDICTABLE;
```

FLDMX

Encoding T1/A1 behaves as described by the pseudocode if imm8 is odd. However, there is no UAL syntax for such encodings and their use is deprecated. For more information, see *FLDMX*, *FSTMX* on page A8-101.

Assembler syntax

VPOP<c><q>{.<size>} <list>

where:

- <c><q> See *Standard assembler syntax fields* on page A8-7.
- <size> An optional data size specifier. If present, it must be equal to the size in bits, 32 or 64, of the registers in <list>.
- <list> The extension registers to be loaded, as a list of consecutively numbered doubleword (encoding T1 / A1) or singleword (encoding T2 / A2) registers, separated by commas and surrounded by brackets. It is encoded in the instruction by setting D and Vd to specify the first register in the list, and imm8 to twice the number of registers in the list (encoding T1 / A1) or the number of registers in the list (encoding T2 / A2). <list> must contain at least one register, and not more than sixteen.

Operation

```

if ConditionPassed() then
    EncodingSpecificOperations(); CheckVFPEnabled(TRUE); NullCheckIfThumbEE(13);
    address = SP;
    SP = SP + imm32;
    if single_regs then
        for r = 0 to regs-1
            S[d+r] = MemA[address,4]; address = address+4;
    else
        for r = 0 to regs-1
            word1 = MemA[address,4]; word2 = MemA[address+4,4]; address = address+8;
            // Combine the word-aligned words in the correct order for current endianness.
            D[d+r] = if BigEndian() then word1:word2 else word2:word1;

```

Exceptions

Undefined Instruction, Data Abort.

A8.6.355 VPUSH

Vector Push stores multiple consecutive extension registers to the stack.

Encoding T1 / A1 VFPv2, VFPv3, Advanced SIMD

VPUSH<c> <list> <list> is consecutive 64-bit registers

15	14	13	12	11	10	9	8	7	6	5	4	3	2	1	0	15	14	13	12	11	10	9	8	7	6	5	4	3	2	1	0
1	1	1	0	1	1	0	1	0	D	1	0	1	1	0	1	Vd	1	0	1	1	imm8										
31	30	29	28	27	26	25	24	23	22	21	20	19	18	17	16	15	14	13	12	11	10	9	8	7	6	5	4	3	2	1	0
cond		1	1	0	1	0	D	1	0	1	1	0	1	Vd	1	0	1	1	imm8												

```
single_regs = FALSE; d = UInt(D:Vd); imm32 = ZeroExtend(imm8:'00', 32);
regs = UInt(imm8) DIV 2; // If UInt(imm8) is odd, see "FSTMX".
if regs == 0 || regs > 16 || (d+regs) > 32 then UNPREDICTABLE;
```

Encoding T2 / A2 VFPv2, VFPv3

VPUSH<c> <list> <list> is consecutive 32-bit registers

15	14	13	12	11	10	9	8	7	6	5	4	3	2	1	0	15	14	13	12	11	10	9	8	7	6	5	4	3	2	1	0
1	1	1	0	1	1	0	1	0	D	1	0	1	1	0	1	Vd	1	0	1	0	imm8										
31	30	29	28	27	26	25	24	23	22	21	20	19	18	17	16	15	14	13	12	11	10	9	8	7	6	5	4	3	2	1	0
cond		1	1	0	1	0	D	1	0	1	1	0	1	Vd	1	0	1	0	imm8												

```
single_regs = TRUE; d = UInt(Vd:D);
imm32 = ZeroExtend(imm8:'00', 32); regs = UInt(imm8);
if regs == 0 || regs > 16 || (d+regs) > 32 then UNPREDICTABLE;
```

FSTMX

Encoding T1/A1 behaves as described by the pseudocode if imm8 is odd.
 However, there is no UAL syntax for such encodings and their use is deprecated.
 For more information, see *FLDMX*, *FSTMX* on page A8-101.

Assembler syntax

VPUSh<c><q>[.<size>] <list>

where:

- <c><q> See *Standard assembler syntax fields* on page A8-7.
- <size> An optional data size specifier. If present, it must be equal to the size in bits, 32 or 64, of the registers in <list>.
- <list> The extension registers to be stored, as a list of consecutively numbered doubleword (encoding T1 / A1) or singleword (encoding T2 / A2) registers, separated by commas and surrounded by brackets. It is encoded in the instruction by setting D and Vd to specify the first register in the list, and imm8 to twice the number of registers in the list (encoding T1 / A1), or the number of registers in the list (encoding T2 / A2). <list> must contain at least one register, and not more than sixteen.

Operation

```

if ConditionPassed() then
    EncodingSpecificOperations(); CheckVFPEnabled(TRUE); NullCheckIfThumbEE(13);
    address = SP - imm32;
    SP = SP - imm32;
    if single_regs then
        for r = 0 to regs-1
            MemA[address,4] = S[d+r]; address = address+4;
    else
        for r = 0 to regs-1
            // Store as two word-aligned words in the correct order for current endianness.
            MemA[address,4] = if BigEndian() then D[d+r]<63:32> else D[d+r]<31:0>;
            MemA[address+4,4] = if BigEndian() then D[d+r]<31:0> else D[d+r]<63:32>;
            address = address+8;

```

Exceptions

Undefined Instruction, Data Abort.

A8.6.356 VQABS

Vector Saturating Absolute takes the absolute value of each element in a vector, and places the results in the destination vector.

If any of the results overflow, they are saturated. The cumulative saturation flag, QC, is set if saturation occurs. For details see *Pseudocode details of saturation* on page A2-9.

Encoding T1 / A1 Advanced SIMD

VQABS<c>.<dt> <Qd>, <Qm>

VQABS<c>.<dt> <Dd>, <Dm>

15	14	13	12	11	10	9	8	7	6	5	4	3	2	1	0	15	14	13	12	11	10	9	8	7	6	5	4	3	2	1	0
1	1	1	1	1	1	1	1	D	1	1	size	0	0	Vd	0	1	1	1	0	Q	M	0	Vm								
31	30	29	28	27	26	25	24	23	22	21	20	19	18	17	16	15	14	13	12	11	10	9	8	7	6	5	4	3	2	1	0
1	1	1	1	0	0	1	1	1	D	1	1	size	0	0	Vd	0	1	1	1	0	Q	M	0	Vm							

```

if size == '11' then UNDEFINED;
if Q == '1' && (Vd<0> == '1' || Vm<0> == '1') then UNDEFINED;
esize = 8 << UInt(size); elements = 64 DIV esize;
d = UInt(D:Vd); m = UInt(M:Vm); regs = if Q == '0' then 1 else 2;
    
```

Assembler syntax

VQABS<c><q>.<dt> <Qd>, <Qm> Encoded as Q = 1
 VQABS<c><q>.<dt> <Dd>, <Dm> Encoded as Q = 0

where:

<c><q> See *Standard assembler syntax fields* on page A8-7. An ARM VQABS instruction must be unconditional.

<dt> The data type for the elements of the vectors. It must be one of:
 S8 encoded as size = 0b00
 S16 encoded as size = 0b01
 S32 encoded as size = 0b10.

<Qd>, <Qm> The destination vector and the operand vector, for a quadword operation.

<Dd>, <Dm> The destination vector and the operand vector, for a doubleword operation.

Operation

```
if ConditionPassed() then
  EncodingSpecificOperations(); CheckAdvSIMDEnabled();
  for r = 0 to regs-1
    for e = 0 to elements-1
      result = Abs(SInt(Elem[D[m+r],e,esize]));
      (Elem[D[d+r],e,esize], sat) = SignedSatQ(result, esize);
      if sat then FPSCR.QC = '1';
```

Exceptions

Undefined Instruction.

A8.6.357 VQADD

Vector Saturating Add adds the values of corresponding elements of two vectors, and places the results in the destination vector.

If any of the results overflow, they are saturated. The cumulative saturation flag, QC, is set if saturation occurs. For details see *Pseudocode details of saturation* on page A2-9.

Encoding T1 / A1 Advanced SIMD

VQADD<c>.<dt> <Qd>, <Qn>, <Qm>

VQADD<c>.<dt> <Dd>, <Dn>, <Dm>

15	14	13	12	11	10	9	8	7	6	5	4	3	2	1	0	15	14	13	12	11	10	9	8	7	6	5	4	3	2	1	0
1	1	1	U	1	1	1	1	0	D	size	Vn				Vd				0	0	0	0	N	Q	M	1	Vm				
31	30	29	28	27	26	25	24	23	22	21	20	19	18	17	16	15	14	13	12	11	10	9	8	7	6	5	4	3	2	1	0
1	1	1	1	0	0	1	U	0	D	size	Vn				Vd				0	0	0	0	N	Q	M	1	Vm				

```

if Q == '1' && (Vd<0> == '1' || Vn<0> == '1' || Vm<0> == '1') then UNDEFINED;
unsigned = (U == '1');
esize = 8 << UInt(size); elements = 64 DIV esize;
d = UInt(D:Vd); n = UInt(N:Vn); m = UInt(M:Vm); regs = if Q == '0' then 1 else 2;
    
```

Assembler syntax

VQADD<c><q>.<type><size> {<Qd>,<Qn>,<Qm> Encoded as Q = 1
 VQADD<c><q>.<type><size> {<Dd>,<Dn>,<Dm> Encoded as Q = 0

where:

<c><q> See *Standard assembler syntax fields* on page A8-7. An ARM VQADD instruction must be unconditional.

<type> The data type for the elements of the vectors. It must be one of:
 S signed, encoded as U = 0
 U unsigned, encoded as U = 1.

<size> The data size for the elements of the vectors. It must be one of:
 8 encoded as size = 0b00
 16 encoded as size = 0b01
 32 encoded as size = 0b10
 64 encoded as size = 0b11.

<Qd>, <Qn>, <Qm> The destination vector and the operand vectors, for a quadword operation.

<Dd>, <Dn>, <Dm> The destination vector and the operand vectors, for a doubleword operation.

Operation

```
if ConditionPassed() then
    EncodingSpecificOperations(); CheckAdvSIMDEnabled();
    for r = 0 to regs-1
        for e = 0 to elements-1
            sum = Int(Elem[D[n+r],e,esize], unsigned) + Int(Elem[D[m+r],e,esize], unsigned);
            (Elem[D[d+r],e,esize], sat) = SatQ(sum, esize, unsigned);
            if sat then FPSCR.QC = '1';
```

Exceptions

Undefined Instruction.

A8.6.358 VQDMLAL, VQDMLSL

Vector Saturating Doubling Multiply Accumulate Long multiplies corresponding elements in two doubleword vectors, doubles the products, and accumulates the results into the elements of a quadword vector.

Vector Saturating Doubling Multiply Subtract Long multiplies corresponding elements in two doubleword vectors, subtracts double the products from corresponding elements of a quadword vector, and places the results in the same quadword vector.

In both instructions, the second operand can be a scalar instead of a vector. For more information about scalars see *Advanced SIMD scalars* on page A7-9.

If any of the results overflow, they are saturated. The cumulative saturation flag, QC, is set if saturation occurs. For details see *Pseudocode details of saturation* on page A2-9.

Encoding T1 / A1 Advanced SIMD

VQD<op><c>.<dt> <Qd>, <Dn>, <Dm>

15	14	13	12	11	10	9	8	7	6	5	4	3	2	1	0	15	14	13	12	11	10	9	8	7	6	5	4	3	2	1	0
1	1	1	0	1	1	1	1	1	D	size	Vn		Vd		1	0	op	1	N	0	M	0	Vm								
31	30	29	28	27	26	25	24	23	22	21	20	19	18	17	16	15	14	13	12	11	10	9	8	7	6	5	4	3	2	1	0
1	1	1	1	0	0	1	0	1	D	size	Vn		Vd		1	0	op	1	N	0	M	0	Vm								

```

if size == '11' then SEE "Related encodings";
if size == '00' || Vd<0> == '1' then UNDEFINED;
add = (op == '0');
scalar_form = FALSE; d = UInt(D:Vd); n = UInt(N:Vn); m = UInt(M:Vm);
esize = 8 << UInt(size); elements = 64 DIV esize;
    
```

Encoding T2 / A2 Advanced SIMD

VQD<op><c>.<dt> <Qd>, <Dn>, <Dm[x]>

15	14	13	12	11	10	9	8	7	6	5	4	3	2	1	0	15	14	13	12	11	10	9	8	7	6	5	4	3	2	1	0
1	1	1	0	1	1	1	1	1	D	size	Vn		Vd		0	op	1	1	N	1	M	0	Vm								
31	30	29	28	27	26	25	24	23	22	21	20	19	18	17	16	15	14	13	12	11	10	9	8	7	6	5	4	3	2	1	0
1	1	1	1	0	0	1	0	1	D	size	Vn		Vd		0	op	1	1	N	1	M	0	Vm								

```

if size == '11' then SEE "Related encodings";
if size == '00' || Vd<0> == '1' then UNDEFINED;
add = (op == '0');
scalar_form = TRUE; d = UInt(D:Vd); n = UInt(N:Vn);
if size == '01' then esize = 16; elements = 4; m = UInt(Vm<2:0>); index = UInt(M:Vm<3>);
if size == '10' then esize = 32; elements = 2; m = UInt(Vm); index = UInt(M);
    
```

Related encodings See *Advanced SIMD data-processing instructions* on page A7-10

Assembler syntax

```
VQD<op><c><q>.<dt> <Qd>, <Dn>, <Dm>
VQD<op><c><q>.<dt> <Qd>, <Dn>, <Dm[x]>
```

where:

<op> Must be one of:
 MLAL encoded as op = 0
 MLSL encoded as op = 1.

<c><q> See *Standard assembler syntax fields* on page A8-7. An ARM VQDMLAL or VQDMSL instruction must be unconditional.

<dt> The data type for the elements of the operands. It must be one of:
 S16 encoded as size = 0b01
 S32 encoded as size = 0b10.

<Qd>, <Dn> The destination vector and the first operand vector.

<Dm> The second operand vector, for an all vector operation.

<Dm[x]> The scalar for a scalar operation. If <dt> is S16, Dm is restricted to D0-D7. If <dt> is S32, Dm is restricted to D0-D15.

Operation

```
if ConditionPassed() then
    EncodingSpecificOperations(); CheckAdvSIMDEnabled();
    if scalar_form then op2 = SInt(Elem[D[m],index,esize]);
    for e = 0 to elements-1
        if !scalar_form then op2 = SInt(Elem[D[m],e,esize]);
        op1 = SInt(Elem[D[n],e,esize]);
        // The following only saturates if both op1 and op2 equal -(2^(esize-1))
        (product, sat1) = SignedSatQ(2*op1*op2, 2*esize);
        if add then
            result = SInt(Elem[Q[d>>1],e,2*esize]) + SInt(product);
        else
            result = SInt(Elem[Q[d>>1],e,2*esize]) - SInt(product);
        (Elem[Q[d>>1],e,2*esize], sat2) = SignedSatQ(result, 2*esize);
        if sat1 || sat2 then FPSCR.QC = '1';
```

Exceptions

Undefined Instruction.

A8.6.359 VQDMULH

Vector Saturating Doubling Multiply Returning High Half multiplies corresponding elements in two vectors, doubles the results, and places the most significant half of the final results in the destination vector. The results are truncated (for rounded results see *VQRDMULH* on page A8-712).

The second operand can be a scalar instead of a vector. For more information about scalars see *Advanced SIMD scalars* on page A7-9.

If any of the results overflow, they are saturated. The cumulative saturation flag, QC, is set if saturation occurs. For details see *Pseudocode details of saturation* on page A2-9.

Encoding T1 / A1 Advanced SIMD

VQDMULH<c>.<dt> <Qd>, <Qn>, <Qm>

VQDMULH<c>.<dt> <Dd>, <Dn>, <Dm>

15	14	13	12	11	10	9	8	7	6	5	4	3	2	1	0	15	14	13	12	11	10	9	8	7	6	5	4	3	2	1	0
1	1	1	0	1	1	1	1	0	D	size	Vn	Vd	1	0	1	1	N	Q	M	0	Vm										
31	30	29	28	27	26	25	24	23	22	21	20	19	18	17	16	15	14	13	12	11	10	9	8	7	6	5	4	3	2	1	0
1	1	1	1	0	0	1	0	0	D	size	Vn	Vd	1	0	1	1	N	Q	M	0	Vm										

```

if Q == '1' && (Vd<0> == '1' || Vn<0> == '1' || Vm<0> == '1') then UNDEFINED;
if size == '00' || size == '11' then UNDEFINED;
scalar_form = FALSE; esize = 8 << UInt(size); elements = 64 DIV esize;
d = UInt(D:Vd); n = UInt(N:Vn); m = UInt(M:Vm); regs = if Q == '0' then 1 else 2;
    
```

Encoding T2 / A2 Advanced SIMD

VQDMULH<c>.<dt> <Qd>, <Qn>, <Dm[x]>

VQDMULH<c>.<dt> <Dd>, <Dn>, <Dm[x]>

15	14	13	12	11	10	9	8	7	6	5	4	3	2	1	0	15	14	13	12	11	10	9	8	7	6	5	4	3	2	1	0
1	1	1	Q	1	1	1	1	1	D	size	Vn	Vd	1	1	0	0	N	1	M	0	Vm										
31	30	29	28	27	26	25	24	23	22	21	20	19	18	17	16	15	14	13	12	11	10	9	8	7	6	5	4	3	2	1	0
1	1	1	1	0	0	1	Q	1	D	size	Vn	Vd	1	1	0	0	N	1	M	0	Vm										

```

if Q == '1' && (Vd<0> == '1' || Vn<0> == '1') then UNDEFINED;
if size == '00' || size == '11' then UNDEFINED;
scalar_form = TRUE; d = UInt(D:Vd); n = UInt(N:Vn); regs = if Q == '0' then 1 else 2;
if size == '01' then esize = 16; elements = 4; m = UInt(Vm<2:0>); index = UInt(M:Vm<3>);
if size == '10' then esize = 32; elements = 2; m = UInt(Vm); index = UInt(M);
    
```

Related encodings See *Advanced SIMD data-processing instructions* on page A7-10

Assembler syntax

VQDMULH<c><q>.<dt> {<Qd>,<Qn>,<Qm>	Encoding T1 / A1, Q = 1
VQDMULH<c><q>.<dt> {<Dd>,<Dn>,<Dm>	Encoding T1 / A1, Q = 0
VQDMULH<c><q>.<dt> {<Qd>,<Qn>,<Dm[x]>	Encoding T2 / A2, U = 1
VQDMULH<c><q>.<dt> {<Dd>,<Dn>,<Dm[x]>	Encoding T2 / A2, U = 0

where:

<c><q>	See <i>Standard assembler syntax fields</i> on page A8-7. An ARM VQDMULH instruction must be unconditional.
<dt>	The data type for the elements of the operands. It must be one of: S16 encoded as size = 0b01 S32 encoded as size = 0b10.
<Qd>,<Qn>	The destination vector and the first operand vector, for a quadword operation.
<Dd>,<Dn>	The destination vector and the first operand vector, for a doubleword operation.
<Qm>	The second operand vector, for a quadword all vector operation.
<Dm>	The second operand vector, for a doubleword all vector operation.
<Dm[x]>	The scalar for either a quadword or a doubleword scalar operation. If <dt> is S16, Dm is restricted to D0-D7. If <dt> is S32, Dm is restricted to D0-D15.

Operation

```

if ConditionPassed() then
    EncodingSpecificOperations(); CheckAdvSIMDEnabled();
    if scalar_form then op2 = SInt(Elem[D[m],index,esize]);
    for r = 0 to regs-1
        for e = 0 to elements-1
            if !scalar_form then op2 = SInt(Elem[D[m+r],e,esize]);
            op1 = SInt(Elem[D[n+r],e,esize]);
            // The following only saturates if both op1 and op2 equal -(2^(esize-1))
            (result, sat) = SignedSatQ((2*op1*op2) >> esize, esize);
            Elem[D[d+r],e,esize] = result;
            if sat then FPSCR.QC = '1';

```

Exceptions

Undefined Instruction.

A8.6.360 VQDMULL

Vector Saturating Doubling Multiply Long multiplies corresponding elements in two doubleword vectors, doubles the products, and places the results in a quadword vector.

The second operand can be a scalar instead of a vector. For more information about scalars see *Advanced SIMD scalars* on page A7-9.

If any of the results overflow, they are saturated. The cumulative saturation flag, QC, is set if saturation occurs. For details see *Pseudocode details of saturation* on page A2-9.

Encoding T1 / A1 Advanced SIMD

VQDMULL<c>.<dt> <Qd>, <Dn>, <Dm>

15	14	13	12	11	10	9	8	7	6	5	4	3	2	1	0	15	14	13	12	11	10	9	8	7	6	5	4	3	2	1	0
1	1	1	0	1	1	1	1	1	D	size	Vn			Vd	1	1	0	1	N	0	M	0	Vm								
31	30	29	28	27	26	25	24	23	22	21	20	19	18	17	16	15	14	13	12	11	10	9	8	7	6	5	4	3	2	1	0
1	1	1	1	0	0	1	0	1	D	size	Vn			Vd	1	1	0	1	N	0	M	0	Vm								

```

if size == '11' then SEE "Related encodings";
if size == '00' || Vd<0> == '1' then UNDEFINED;
scalar_form = FALSE; d = UInt(D:Vd); n = UInt(N:Vn); m = UInt(M:Vm);
esize = 8 << UInt(size); elements = 64 DIV esize;
    
```

Encoding T2 / A2 Advanced SIMD

VQDMULL<c>.<dt> <Qd>, <Dn>, <Dm[x]>

15	14	13	12	11	10	9	8	7	6	5	4	3	2	1	0	15	14	13	12	11	10	9	8	7	6	5	4	3	2	1	0
1	1	1	0	1	1	1	1	1	D	size	Vn			Vd	1	0	1	1	N	1	M	0	Vm								
31	30	29	28	27	26	25	24	23	22	21	20	19	18	17	16	15	14	13	12	11	10	9	8	7	6	5	4	3	2	1	0
1	1	1	1	0	0	1	0	1	D	size	Vn			Vd	1	0	1	1	N	1	M	0	Vm								

```

if size == '11' then SEE "Related encodings";
if size == '00' || Vd<0> == '1' then UNDEFINED;
scalar_form = TRUE; d = UInt(D:Vd); n = UInt(N:Vn);
if size == '01' then esize = 16; elements = 4; m = UInt(Vm<2:0>); index = UInt(M:Vm<3>);
if size == '10' then esize = 32; elements = 2; m = UInt(Vm); index = UInt(M);
    
```

Related encodings See *Advanced SIMD data-processing instructions* on page A7-10

Assembler syntax

```
VQDMULL<c><q>.<dt> <Qd>, <Dn>, <Dm>
VQDMULL<c><q>.<dt> <Qd>, <Dn>, <Dm[x]>
```

where:

<c><q>	See <i>Standard assembler syntax fields</i> on page A8-7. An ARM VQDMULL instruction must be unconditional.
<dt>	The data type for the elements of the operands. It must be one of: S16 encoded as size = 0b01 S32 encoded as size = 0b10.
<Qd>, <Dn>	The destination vector and the first operand vector.
<Dm>	The second operand vector, for an all vector operation.
<Dm[x]>	The scalar for a scalar operation. If <dt> is S16, Dm is restricted to D0-D7. If <dt> is S32, Dm is restricted to D0-D15.

Operation

```
if ConditionPassed() then
    EncodingSpecificOperations(); CheckAdvSIMDEnabled();
    if scalar_form then op2 = SInt(Elem[D[m],index,esize]);
    for e = 0 to elements-1
        if !scalar_form then op2 = SInt(Elem[D[m],e,esize]);
        op1 = SInt(Elem[D[n],e,esize]);
        // The following only saturates if both op1 and op2 equal -(2^(esize-1))
        (product, sat) = SignedSatQ(2*op1*op2, 2*esize);
        Elem[Q[d>>1],e,2*esize] = product;
        if sat then FPSCR.QC = '1';
```

Exceptions

Undefined Instruction.

A8.6.361 VQMOVN, VQMOVUN

Vector Saturating Move and Narrow copies each element of the operand vector to the corresponding element of the destination vector.

The operand is a quadword vector. The elements can be any one of:

- 16-bit, 32-bit, or 64-bit signed integers
- 16-bit, 32-bit, or 64-bit unsigned integers.

The result is a doubleword vector. The elements are half the length of the operand vector elements. If the operand is unsigned, the results are unsigned. If the operand is signed, the results can be signed or unsigned.

If any of the results overflow, they are saturated. The cumulative saturation flag, QC, is set if saturation occurs. For details see *Pseudocode details of saturation* on page A2-9.

Encoding T1 / A1 Advanced SIMD

VQMOV{U}N<c>.<type><size> <Dd>, <Qm>

15	14	13	12	11	10	9	8	7	6	5	4	3	2	1	0	15	14	13	12	11	10	9	8	7	6	5	4	3	2	1	0
1	1	1	1	1	1	1	1	D	1	1	size	1	0	Vd	0	0	1	0	op	M	0	Vm									
31	30	29	28	27	26	25	24	23	22	21	20	19	18	17	16	15	14	13	12	11	10	9	8	7	6	5	4	3	2	1	0
1	1	1	1	0	0	1	1	1	D	1	1	size	1	0	Vd	0	0	1	0	op	M	0	Vm								

```

if op == '00' then SEE VMOVN;
if size == '11' || Vm<0> == '1' then UNDEFINED;
source_unsigned = (op == '11'); dest_unsigned = (op<0> == '1');
esize = 8 << UInt(size); elements = 64 DIV esize;
d = UInt(D:Vd); m = UInt(M:Vm);
    
```

Assembler syntax

VQMOV{U}N<C><q>.<type><size> <Dd>, <Qm>

where:

U If present, specifies that the operation produces unsigned results, even though the operands are signed. Encoded as op = 0b01.

<C><q> See *Standard assembler syntax fields* on page A8-7. An ARM VQMOVN or VQMOVUN instruction must be unconditional.

<type> The data type for the elements of the operand. It must be one of:

S encoded as:

- op = 0b10 for VQMOVN
- op = 0b01 for VQMOVUN.

U encoded as op = 0b11. Not available for VQMOVUN.

<size> The data size for the elements of the operand. It must be one of:

16 encoded as size = 0b00

32 encoded as size = 0b01

64 encoded as size = 0b10.

<Dd>, <Qm> The destination vector and the operand vector.

Operation

```
if ConditionPassed() then
    EncodingSpecificOperations(); CheckAdvSIMDEnabled();
    for e = 0 to elements-1
        operand = Int(Elem[Q[m]>>1],e,2*esize], src_unsigned);
        (Elem[D[d],e,esize], sat) = SatQ(operand, esize, dest_unsigned);
        if sat then FPSCR.QC = '1';
```

Exceptions

Undefined Instruction.

A8.6.362 VQNEG

Vector Saturating Negate negates each element in a vector, and places the results in the destination vector.

If any of the results overflow, they are saturated. The cumulative saturation flag, QC, is set if saturation occurs. For details see *Pseudocode details of saturation* on page A2-9.

Encoding T1 / A1 Advanced SIMD

VQNEG<c>.<dt> <Qd>, <Qm>

VQNEG<c>.<dt> <Dd>, <Dm>

15	14	13	12	11	10	9	8	7	6	5	4	3	2	1	0	15	14	13	12	11	10	9	8	7	6	5	4	3	2	1	0
1	1	1	1	1	1	1	1	D	1	1	size	0	0	Vd	0	1	1	1	1	Q	M	0	Vm								
31	30	29	28	27	26	25	24	23	22	21	20	19	18	17	16	15	14	13	12	11	10	9	8	7	6	5	4	3	2	1	0
1	1	1	1	0	0	1	1	1	D	1	1	size	0	0	Vd	0	1	1	1	1	Q	M	0	Vm							

```

if size == '11' then UNDEFINED;
if Q == '1' && (Vd<0> == '1' || Vm<0> == '1') then UNDEFINED;
esize = 8 << UInt(size); elements = 64 DIV esize;
d = UInt(D:Vd); m = UInt(M:Vm); regs = if Q == '0' then 1 else 2;
    
```

Assembler syntax

VQNEG<c><q>.<dt> <Qd>, <Qm> Encoded as Q = 1
 VQNEG<c><q>.<dt> <Dd>, <Dm> Encoded as Q = 0

where:

<c><q> See *Standard assembler syntax fields* on page A8-7. An ARM VQNEG instruction must be unconditional.

<dt> The data type for the elements of the vectors. It must be one of:
 S8 encoded as size = 0b00
 S16 encoded as size = 0b01
 S32 encoded as size = 0b10.

<Qd>, <Qm> The destination vector and the operand vector, for a quadword operation.

<Dd>, <Dm> The destination vector and the operand vector, for a doubleword operation.

Operation

```
if ConditionPassed() then
  EncodingSpecificOperations(); CheckAdvSIMDEnabled();
  for r = 0 to regs-1
    for e = 0 to elements-1
      result = -SInt(Elem[D[m+r],e,esize]);
      (Elem[D[d+r],e,esize], sat) = SignedSatQ(result, esize);
      if sat then FPSCR.QC = '1';
```

Exceptions

Undefined Instruction.

A8.6.363 VQRDMULH

Vector Saturating Rounding Doubling Multiply Returning High Half multiplies corresponding elements in two vectors, doubles the results, and places the most significant half of the final results in the destination vector. The results are rounded (for truncated results see *VQDMULH* on page A8-704).

The second operand can be a scalar instead of a vector. For more information about scalars see *Advanced SIMD scalars* on page A7-9.

If any of the results overflow, they are saturated. The cumulative saturation flag, QC, is set if saturation occurs. For details see *Pseudocode details of saturation* on page A2-9.

Encoding T1 / A1 Advanced SIMD

VQRDMULH<c>.<dt> <Qd>, <Qn>, <Qm>

VQRDMULH<c>.<dt> <Dd>, <Dn>, <Dm>

15	14	13	12	11	10	9	8	7	6	5	4	3	2	1	0	15	14	13	12	11	10	9	8	7	6	5	4	3	2	1	0
1	1	1	1	1	1	1	1	0	D	size	Vn				Vd				1	0	1	1	N	Q	M	0	Vm				
31	30	29	28	27	26	25	24	23	22	21	20	19	18	17	16	15	14	13	12	11	10	9	8	7	6	5	4	3	2	1	0
1	1	1	1	1	0	0	1	1	0	D	size	Vn				Vd				1	0	1	1	N	Q	M	0	Vm			

```

if Q == '1' && (Vd<0> == '1' || Vn<0> == '1' || Vm<0> == '1') then UNDEFINED;
if size == '00' || size == '11' then UNDEFINED;
scalar_form = FALSE; esize = 8 << UInt(size); elements = 64 DIV esize;
d = UInt(D:Vd); n = UInt(N:Vn); m = UInt(M:Vm); regs = if Q == '0' then 1 else 2;
    
```

Encoding T2 / A2 Advanced SIMD

VQRDMULH<c>.<dt> <Qd>, <Qn>, <Dm[x]>

VQRDMULH<c>.<dt> <Dd>, <Dn>, <Dm[x]>

15	14	13	12	11	10	9	8	7	6	5	4	3	2	1	0	15	14	13	12	11	10	9	8	7	6	5	4	3	2	1	0
1	1	1	Q	1	1	1	1	1	D	size	Vn				Vd				1	1	0	1	N	1	M	0	Vm				
31	30	29	28	27	26	25	24	23	22	21	20	19	18	17	16	15	14	13	12	11	10	9	8	7	6	5	4	3	2	1	0
1	1	1	1	0	0	1	Q	1	D	size	Vn				Vd				1	1	0	1	N	1	M	0	Vm				

```

if Q == '1' && (Vd<0> == '1' || Vn<0> == '1') then UNDEFINED;
if size == '00' || size == '11' then UNDEFINED;
scalar_form = TRUE; d = UInt(D:Vd); n = UInt(N:Vn); regs = if Q == '0' then 1 else 2;
if size == '01' then esize = 16; elements = 4; m = UInt(Vm<2:0>); index = UInt(M:Vm<3>);
if size == '10' then esize = 32; elements = 2; m = UInt(Vm); index = UInt(M);
    
```

Related encodings See *Advanced SIMD data-processing instructions* on page A7-10

Assembler syntax

VQRDMULH<c><q>.<dt>	{<Qd>, } <Qn>, <Qm>	Encoding T1 / A1, Q = 1
VQRDMULH<c><q>.<dt>	{<Dd>, } <Dn>, <Dm>	Encoding T1 / A1, Q = 0
VQRDMULH<c><q>.<dt>	{<Qd>, } <Qn>, <Dm[x]>	Encoding T2 / A2, Q = 1
VQRDMULH<c><q>.<dt>	{<Dd>, } <Dn>, <Dm[x]>	Encoding T2 / A2, Q = 0

where:

<c><q>	See <i>Standard assembler syntax fields</i> on page A8-7. An ARM VQRDMULH instruction must be unconditional.
<dt>	The data type for the elements of the operands. It must be one of: S16 encoded as size = 0b01 S32 encoded as size = 0b10.
<Qd>, <Qn>	The destination vector and the first operand vector, for a quadword operation.
<Dd>, <Dn>	The destination vector and the first operand vector, for a doubleword operation.
<Qm>	The second operand vector, for a quadword all vector operation.
<Dm>	The second operand vector, for a doubleword all vector operation.
<Dm[x]>	The scalar for either a quadword or a doubleword scalar operation. If <dt> is S16, Dm is restricted to D0-D7. If <dt> is S32, Dm is restricted to D0-D15.

Operation

```

if ConditionPassed() then
    EncodingSpecificOperations(); CheckAdvSIMDEnabled();
    round_const = 1 << (esize-1);
    if scalar_form then op2 = SInt(Elem[D[m],index,esize]);
    for r = 0 to regs-1
        for e = 0 to elements-1
            op1 = SInt(Elem[D[n+r],e,esize]);
            if !scalar_form then op2 = SInt(Elem[D[m+r],e,esize]);
            (result, sat) = SignedSatQ((2*op1*op2 + round_const) >> esize, esize);
            Elem[D[d+r],e,esize] = result;
            if sat then FPSCR.QC = '1';

```

Exceptions

Undefined Instruction.

A8.6.364 VQRSHL

Vector Saturating Rounding Shift Left takes each element in a vector, shifts them by a value from the least significant byte of the corresponding element of a second vector, and places the results in the destination vector. If the shift value is positive, the operation is a left shift. Otherwise, it is a right shift.

For truncated results see *VQSHL (register)* on page A8-718.

The first operand and result elements are the same data type, and can be any one of:

- 8-bit, 16-bit, 32-bit, or 64-bit signed integers
- 8-bit, 16-bit, 32-bit, or 64-bit unsigned integers.

The second operand is a signed integer of the same size.

If any of the results overflow, they are saturated. The cumulative saturation flag, QC, is set if saturation occurs. For details see *Pseudocode details of saturation* on page A2-9.

Encoding T1 / A1 Advanced SIMD

VQRSHL<c>.<type><size> <Qd>,<Qm>,<Qn>

VQRSHL<c>.<type><size> <Dd>,<Dm>,<Dn>

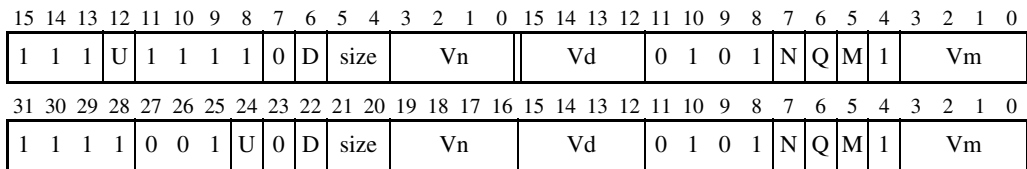

```

if Q == '1' && (Vd<0> == '1' || Vm<0> == '1' || Vn<0> == '1') then UNDEFINED;
unsigned = (U == '1');
esize = 8 << UInt(size);  elements = 64 DIV esize;
d = UInt(D:Vd);  m = UInt(M:Vm);  n = UInt(N:Vn);  regs = if Q == '0' then 1 else 2;
    
```

Assembler syntax

VQRSHL<c><q>.<type><size> {<Qd>,<Qm>,<Qn> Encoded as Q = 1
 VQRSHL<c><q>.<type><size> {<Dd>,<Dm>,<Dn> Encoded as Q = 0

where:

<c><q> See *Standard assembler syntax fields* on page A8-7. An ARM VQRSHL instruction must be unconditional.

<type> The data type for the elements of the vectors. It must be one of:
 S signed, encoded as U = 0
 U unsigned, encoded as U = 1.

<size> The data size for the elements of the vectors. It must be one of:
 8 encoded as size = 0b00
 16 encoded as size = 0b01
 32 encoded as size = 0b10
 64 encoded as size = 0b11.

<Qd>, <Qm>, <Qn> The destination vector and the operand vectors, for a quadword operation.

<Dd>, <Dm>, <Dn> The destination vector and the operand vectors, for a doubleword operation.

Operation

```
if ConditionPassed() then
    EncodingSpecificOperations(); CheckAdvSIMDEnabled();
    for r = 0 to regs-1
        for e = 0 to elements-1
            shift = SInt(Elem[D[n+r],e,esize]<7:0>);
            round_const = 1 << (-1-shift); // 0 for left shift, 2^(n-1) for right shift
            operand = Int(Elem[D[m+r],e,esize], unsigned);
            (result, sat) = SatQ((operand + round_const) << shift, esize, unsigned);
            Elem[D[d+r],e,esize] = result;
            if sat then FPSCR.QC = '1';
```

Exceptions

Undefined Instruction.

A8.6.365 VQRSHRN, VQRSHRUN

Vector Saturating Rounding Shift Right, Narrow takes each element in a quadword vector of integers, right shifts them by an immediate value, and places the rounded results in a doubleword vector.

For truncated results, see *VQSHRN*, *VQSHRUN* on page A8-722.

The operand elements must all be the same size, and can be any one of:

- 16-bit, 32-bit, or 64-bit signed integers
- 16-bit, 32-bit, or 64-bit unsigned integers.

The result elements are half the width of the operand elements. If the operand elements are signed, the results can be either signed or unsigned. If the operand elements are unsigned, the result elements must also be unsigned.

If any of the results overflow, they are saturated. The cumulative saturation flag, QC, is set if saturation occurs. For details see *Pseudocode details of saturation* on page A2-9.

Encoding T1 / A1 Advanced SIMD

VQRSHR{U}N<c>.<type><size> <Dd>,<Qm>,<imm>

15	14	13	12	11	10	9	8	7	6	5	4	3	2	1	0	15	14	13	12	11	10	9	8	7	6	5	4	3	2	1	0
1	1	1	U	1	1	1	1	1	D	imm6						Vd		1	0	0	op	0	1	M	1	Vm					
31	30	29	28	27	26	25	24	23	22	21	20	19	18	17	16	15	14	13	12	11	10	9	8	7	6	5	4	3	2	1	0
1	1	1	1	0	0	1	U	1	D	imm6						Vd		1	0	0	op	0	1	M	1	Vm					

```

if imm6 == '000xxx' then SEE "Related encodings";
if U == '0' && op == '0' then SEE VRSHRN;
if Vm<0> == '1' then UNDEFINED;
case imm6 of
  when '001xxx' esize = 8; elements = 8; shift_amount = 16 - UInt(imm6);
  when '01xxxx' esize = 16; elements = 4; shift_amount = 32 - UInt(imm6);
  when '1xxxxx' esize = 32; elements = 2; shift_amount = 64 - UInt(imm6);
src_unsigned = (U == '1' && op == '1'); dest_unsigned = (U == '1');
d = UInt(D:Vd); m = UInt(M:Vm);
    
```

Related encodings See *One register and a modified immediate value* on page A7-21

Assembler syntax

VQRSHR{U}N<c><q>.<type><size> <Dd>, <Qm>, #<imm>

where:

U	If present, specifies that the results are unsigned, although the operands are signed.						
<c><q>	See <i>Standard assembler syntax fields</i> on page A8-7. An ARM VQRSHRN or VQRSHRUN instruction must be unconditional.						
<type>	The data type for the elements of the vectors. It must be one of: <table> <tr> <td>S</td> <td>encoded as: <table> <tr> <td>U = 0, op = 1, if U is absent</td> </tr> <tr> <td>U = 1, op = 0, if U is present</td> </tr> </table> </td> </tr> <tr> <td>U</td> <td>encoded as U = 1, op = 1. Not available for VQRSHRUN.</td> </tr> </table>	S	encoded as: <table> <tr> <td>U = 0, op = 1, if U is absent</td> </tr> <tr> <td>U = 1, op = 0, if U is present</td> </tr> </table>	U = 0, op = 1, if U is absent	U = 1, op = 0, if U is present	U	encoded as U = 1, op = 1. Not available for VQRSHRUN.
S	encoded as: <table> <tr> <td>U = 0, op = 1, if U is absent</td> </tr> <tr> <td>U = 1, op = 0, if U is present</td> </tr> </table>	U = 0, op = 1, if U is absent	U = 1, op = 0, if U is present				
U = 0, op = 1, if U is absent							
U = 1, op = 0, if U is present							
U	encoded as U = 1, op = 1. Not available for VQRSHRUN.						
<size>	The data size for the elements of the vectors. It must be one of: <table> <tr> <td>16</td> <td>Encoded as L = '0', imm6<5:3> = '001'. (8 – <imm>) is encoded in imm6<2:0>.</td> </tr> <tr> <td>32</td> <td>Encoded as L = '0', imm6<5:4> = '01'. (16 – <imm>) is encoded in imm6<3:0>.</td> </tr> <tr> <td>64</td> <td>Encoded as L = '0', imm6<5> = '1'. (32 – <imm>) is encoded in imm6<4:0>.</td> </tr> </table>	16	Encoded as L = '0', imm6<5:3> = '001'. (8 – <imm>) is encoded in imm6<2:0>.	32	Encoded as L = '0', imm6<5:4> = '01'. (16 – <imm>) is encoded in imm6<3:0>.	64	Encoded as L = '0', imm6<5> = '1'. (32 – <imm>) is encoded in imm6<4:0>.
16	Encoded as L = '0', imm6<5:3> = '001'. (8 – <imm>) is encoded in imm6<2:0>.						
32	Encoded as L = '0', imm6<5:4> = '01'. (16 – <imm>) is encoded in imm6<3:0>.						
64	Encoded as L = '0', imm6<5> = '1'. (32 – <imm>) is encoded in imm6<4:0>.						
<Dd>, <Qm>	The destination vector and the operand vector.						
<imm>	The immediate value, in the range 1 to <size>/2. See the description of <size> for how <imm> is encoded.						

Operation

```

if ConditionPassed() then
    EncodingSpecificOperations(); CheckAdvSIMDEnabled();
    round_const = 1 << (shift_amount - 1);
    for e = 0 to elements-1
        operand = Int(Elem[Q[m]>>1],e,2*esize], src_unsigned);
        (result, sat) = SatQ((operand + round_const) >> shift_amount, esize, dest_unsigned);
        Elem[D[d],e,esize] = result;
        if sat then FPSCR.QC = '1';
  
```

Exceptions

Undefined Instruction.

Pseudo-instructions

VQRSHRN.I<size> <Dd>, <Qm>, #0	is a synonym for	VQMOVN.I<size> <Dd>, <Qm>
VQRSHRUN.I<size> <Dd>, <Qm>, #0	is a synonym for	VQMOVUN.I<size> <Dd>, <Qm>

A8.6.366 VQSHL (register)

Vector Saturating Shift Left (register) takes each element in a vector, shifts them by a value from the least significant byte of the corresponding element of a second vector, and places the results in the destination vector. If the shift value is positive, the operation is a left shift. Otherwise, it is a right shift.

The results are truncated. For rounded results, see *VQRSHL* on page A8-714.

The first operand and result elements are the same data type, and can be any one of:

- 8-bit, 16-bit, 32-bit, or 64-bit signed integers
- 8-bit, 16-bit, 32-bit, or 64-bit unsigned integers.

The second operand is a signed integer of the same size.

If any of the results overflow, they are saturated. The cumulative saturation flag, QC, is set if saturation occurs. For details see *Pseudocode details of saturation* on page A2-9.

Encoding T1 / A1 Advanced SIMD

VQSHL<c>.<type><size> <Qd>,<Qm>,<Qn>

VQSHL<c>.<type><size> <Dd>,<Dm>,<Dn>

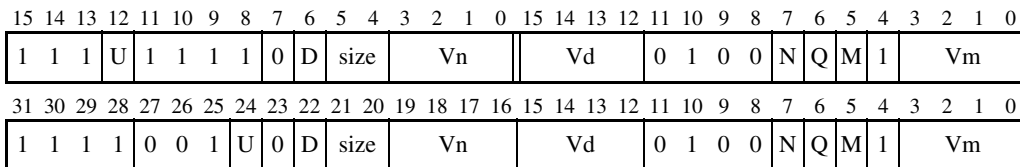

```

if Q == '1' && (Vd<0> == '1' || Vm<0> == '1' || Vn<0> == '1') then UNDEFINED;
unsigned = (U == '1');
esize = 8 << UInt(size);  elements = 64 DIV esize;
d = UInt(D:Vd);  m = UInt(M:Vm);  n = UInt(N:Vn);  regs = if Q == '0' then 1 else 2;
    
```

Assembler syntax

VQSHL<c><q>.<type><size> {<Qd>,<Qm>,<Qn> Encoded as Q = 1
 VQSHL<c><q>.<type><size> {<Dd>,<Dm>,<Dn> Encoded as Q = 0

where:

<c><q> See *Standard assembler syntax fields* on page A8-7. An ARM VQSHL instruction must be unconditional.

<type> The data type for the elements of the vectors. It must be one of:
 S signed, encoded as U = 0
 U unsigned, encoded as U = 1.

<size> The data size for the elements of the vectors. It must be one of:
 8 encoded as size = 0b00
 16 encoded as size = 0b01
 32 encoded as size = 0b10
 64 encoded as size = 0b11.

<Qd>, <Qm>, <Qn> The destination vector and the operand vectors, for a quadword operation.

<Dd>, <Dm>, <Dn> The destination vector and the operand vectors, for a doubleword operation.

Operation

```
if ConditionPassed() then
    EncodingSpecificOperations(); CheckAdvSIMDEnabled();
    for r = 0 to regs-1
        for e = 0 to elements-1
            shift = SInt(Elm[D[n+r],e,esize]<7:0>);
            operand = Int(Elm[D[m+r],e,esize], unsigned);
            (result,sat) = SatQ(operand << shift, esize, unsigned);
            Elm[D[d+r],e,esize] = result;
            if sat then FPSCR.QC = '1';
```

Exceptions

Undefined Instruction.

A8.6.367 VQSHL, VQSHLU (immediate)

Vector Saturating Shift Left (immediate) takes each element in a vector of integers, left shifts them by an immediate value, and places the results in a second vector.

The operand elements must all be the same size, and can be any one of:

- 8-bit, 16-bit, 32-bit, or 64-bit signed integers
- 8-bit, 16-bit, 32-bit, or 64-bit unsigned integers.

The result elements are the same size as the operand elements. If the operand elements are signed, the results can be either signed or unsigned. If the operand elements are unsigned, the result elements must also be unsigned.

If any of the results overflow, they are saturated. The cumulative saturation flag, QC, is set if saturation occurs. For details see *Pseudocode details of saturation* on page A2-9.

Encoding T1 / A1 Advanced SIMD

VQSHL{U}<c>.<type><size> <Qd>, <Qm>, #<imm>

VQSHL{U}<c>.<type><size> <Dd>, <Dm>, #<imm>

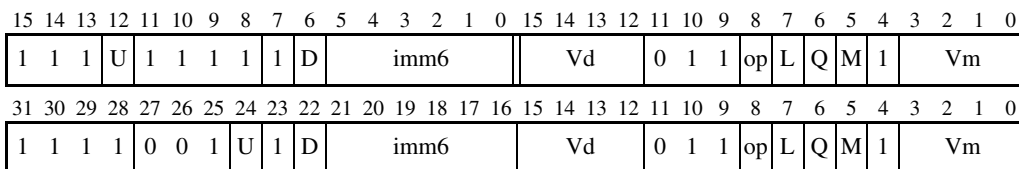

```

if L:imm6 == '0000xxx' then SEE "Related encodings";
if U == '0' && op == '0' then UNDEFINED;
if Q == '1' && (Vd<0> == '1' || Vm<0> == '1') then UNDEFINED;
case L:imm6 of
    when '0001xxx' esize = 8; elements = 8; shift_amount = UInt(imm6) - 8;
    when '001xxxx' esize = 16; elements = 4; shift_amount = UInt(imm6) - 16;
    when '01xxxxx' esize = 32; elements = 2; shift_amount = UInt(imm6) - 32;
    when '1xxxxxx' esize = 64; elements = 1; shift_amount = UInt(imm6);
src_unsigned = (U == '1' && op == '1'); dest_unsigned = (U == '1');
d = UInt(D:Vd); m = UInt(M:Vm); regs = if Q == '0' then 1 else 2;
    
```

Related encodings See *One register and a modified immediate value* on page A7-21

Assembler syntax

VQSHL{U}<C><q>.<type><size> {<Qd>,<Qm>,<#imm> Encoded as Q = 1
 VQSHL{U}<C><q>.<type><size> {<Dd>,<Dm>,<#imm> Encoded as Q = 0

where:

U If present, specifies that the results are unsigned, although the operands are signed.

<C><q> See *Standard assembler syntax fields* on page A8-7. An ARM VQSHL or VQSHLU instruction must be unconditional.

<type> The data type for the elements of the vectors. It must be one of:
 S encoded as:
 U = 0, op = 1, if U is absent
 U = 1, op = 0, if U is present
 U encoded as U = 1, op = 1. Not available for VQSHLU.

<size> The data size for the elements of the vectors. It must be one of:
 8 Encoded as L = '0', imm6<5:3> = '001'. <imm> is encoded in imm6<2:0>.
 16 Encoded as L = '0', imm6<5:4> = '01'. <imm> is encoded in imm6<3:0>.
 32 Encoded as L = '0', imm6<5> = '1'. <imm> is encoded in imm6<4:0>.
 64 Encoded as L = '1'. <imm> is encoded in imm6<5:0>.

<Qd>, <Qm> The destination vector, and the operand vector, for a quadword operation.

<Dd>, <Dm> The destination vector, and the operand vector, for a doubleword operation.

<imm> The immediate value, in the range 0 to <size>-1. See the description of <size> for how <imm> is encoded.

Operation

```
if ConditionPassed() then
    EncodingSpecificOperations(); CheckAdvSIMDEnabled();
    for r = 0 to regs-1
        for e = 0 to elements-1
            operand = Int(Elem[D[m+r],e,esize], src_unsigned);
            (result, sat) = SatQ(operand << shift_amount, esize, dest_unsigned);
            Elem[D[d+r],e,esize] = result;
            if sat then FPSCR.QC = '1';
```

Exceptions

Undefined Instruction.

A8.6.368 VQSHRN, VQSHRUN

Vector Saturating Shift Right, Narrow takes each element in a quadword vector of integers, right shifts them by an immediate value, and places the truncated results in a doubleword vector.

For rounded results, see *VQRSHRN*, *VQRSHRUN* on page A8-716.

The operand elements must all be the same size, and can be any one of:

- 16-bit, 32-bit, or 64-bit signed integers
- 16-bit, 32-bit, or 64-bit unsigned integers.

The result elements are half the width of the operand elements. If the operand elements are signed, the results can be either signed or unsigned. If the operand elements are unsigned, the result elements must also be unsigned.

If any of the results overflow, they are saturated. The cumulative saturation flag, QC, is set if saturation occurs. For details see *Pseudocode details of saturation* on page A2-9.

Encoding T1 / A1 Advanced SIMD

VQSHR{U}N<c>.<type><size> <Dd>,<Qm>,#<imm>

15	14	13	12	11	10	9	8	7	6	5	4	3	2	1	0	15	14	13	12	11	10	9	8	7	6	5	4	3	2	1	0
1	1	1	U	1	1	1	1	1	D	imm6					Vd		1	0	0	op	0	0	M	1	Vm						
31	30	29	28	27	26	25	24	23	22	21	20	19	18	17	16	15	14	13	12	11	10	9	8	7	6	5	4	3	2	1	0
1	1	1	1	0	0	1	U	1	D	imm6					Vd		1	0	0	op	0	0	M	1	Vm						

```

if imm6 == '000xxx' then SEE "Related encodings";
if U == '0' && op == '0' then SEE VSHRN;
if Vm<0> == '1' then UNDEFINED;
case imm6 of
  when '001xxx' esize = 8; elements = 8; shift_amount = 16 - UInt(imm6);
  when '01xxxx' esize = 16; elements = 4; shift_amount = 32 - UInt(imm6);
  when '1xxxxx' esize = 32; elements = 2; shift_amount = 64 - UInt(imm6);
src_unsigned = (U == '1' && op == '1'); dest_unsigned = (U == '1');
d = UInt(D:Vd); m = UInt(M:Vm);
    
```

Related encodings See *One register and a modified immediate value* on page A7-21

Assembler syntax

VQSHR{U}N<c><q>.<type><size> <Dd>, <Qm>, #<imm>

where:

U	If present, specifies that the results are unsigned, although the operands are signed.						
<c><q>	See <i>Standard assembler syntax fields</i> on page A8-7. An ARM VQSHRN or VQSHRUN instruction must be unconditional.						
<type>	The data type for the elements of the vectors. It must be one of: <table> <tr> <td>S</td> <td>encoded as: <table> <tr> <td>U = 0, op = 1, if U is absent</td> </tr> <tr> <td>U = 1, op = 0, if U is present</td> </tr> </table> </td> </tr> <tr> <td>U</td> <td>encoded as U = 1, op = 1. Not available for VQSHRUN.</td> </tr> </table>	S	encoded as: <table> <tr> <td>U = 0, op = 1, if U is absent</td> </tr> <tr> <td>U = 1, op = 0, if U is present</td> </tr> </table>	U = 0, op = 1, if U is absent	U = 1, op = 0, if U is present	U	encoded as U = 1, op = 1. Not available for VQSHRUN.
S	encoded as: <table> <tr> <td>U = 0, op = 1, if U is absent</td> </tr> <tr> <td>U = 1, op = 0, if U is present</td> </tr> </table>	U = 0, op = 1, if U is absent	U = 1, op = 0, if U is present				
U = 0, op = 1, if U is absent							
U = 1, op = 0, if U is present							
U	encoded as U = 1, op = 1. Not available for VQSHRUN.						
<size>	The data size for the elements of the vectors. It must be one of: <table> <tr> <td>16</td> <td>Encoded as imm6<5:3> = '001'. (8 – <imm>) is encoded in imm6<2:0>.</td> </tr> <tr> <td>32</td> <td>Encoded as imm6<5:4> = '01'. (16 – <imm>) is encoded in imm6<3:0>.</td> </tr> <tr> <td>64</td> <td>Encoded as imm6<5> = '1'. (32 – <imm>) is encoded in imm6<4:0>.</td> </tr> </table>	16	Encoded as imm6<5:3> = '001'. (8 – <imm>) is encoded in imm6<2:0>.	32	Encoded as imm6<5:4> = '01'. (16 – <imm>) is encoded in imm6<3:0>.	64	Encoded as imm6<5> = '1'. (32 – <imm>) is encoded in imm6<4:0>.
16	Encoded as imm6<5:3> = '001'. (8 – <imm>) is encoded in imm6<2:0>.						
32	Encoded as imm6<5:4> = '01'. (16 – <imm>) is encoded in imm6<3:0>.						
64	Encoded as imm6<5> = '1'. (32 – <imm>) is encoded in imm6<4:0>.						
<Dd>, <Qm>	The destination vector, and the operand vector.						
<imm>	The immediate value, in the range 1 to <size>/2. See the description of <size> for how <imm> is encoded.						

Operation

```

if ConditionPassed() then
    EncodingSpecificOperations(); CheckAdvSIMDEnabled();
    for e = 0 to elements-1
        operand = Int(Elem[Q[m]>>1],e,2*esize, src_unsigned);
        (result, sat) = SatQ(operand >> shift_amount, esize, dest_unsigned);
        Elem[D[d],e,esize] = result;
        if sat then FPSCR.QC = '1';
  
```

Exceptions

Undefined Instruction.

Pseudo-instructions

VQSHRN.I<size> <Dd>, <Qm>, #0	is a synonym for	VQMOVN.I<size> <Dd>, <Qm>
VQSHRUN.I<size> <Dd>, <Qm>, #0	is a synonym for	VQMOVUN.I<size> <Dd>, <Qm>

A8.6.369 VQSUB

Vector Saturating Subtract subtracts the elements of the second operand vector from the corresponding elements of the first operand vector, and places the results in the destination vector. Signed and unsigned operations are distinct.

The operand and result elements must all be the same type, and can be any one of:

- 8-bit, 16-bit, 32-bit, or 64-bit signed integers
- 8-bit, 16-bit, 32-bit, or 64-bit unsigned integers.

If any of the results overflow, they are saturated. The cumulative saturation flag, QC, is set if saturation occurs. For details see *Pseudocode details of saturation* on page A2-9.

Encoding T1 / A1 Advanced SIMD

VQSUB<c>.<type><size> <Qd>, <Qn>, <Qm>

VQSUB<c>.<type><size> <Dd>, <Dn>, <Dm>

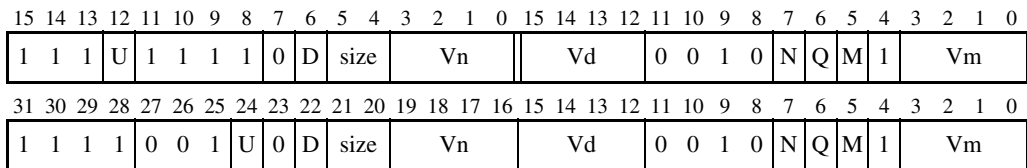

```

if Q == '1' && (Vd<0> == '1' || Vn<0> == '1' || Vm<0> == '1') then UNDEFINED;
unsigned = (U == '1');
esize = 8 << UInt(size); elements = 64 DIV esize;
d = UInt(D:Vd); n = UInt(N:Vn); m = UInt(M:Vm); regs = if Q == '0' then 1 else 2;
    
```

Assembler syntax

VQSUB<c><q>.<type><size> {<Qd>,<Qn>,<Qm> Encoded as Q = 1
 VQSUB<c><q>.<type><size> {<Dd>,<Dn>,<Dm> Encoded as Q = 0

where:

<c><q> See *Standard assembler syntax fields* on page A8-7. An ARM VQSUB instruction must be unconditional.

<type> The data type for the elements of the vectors. It must be one of:
 S signed, encoded as U = 0
 U unsigned, encoded as U = 1.

<size> The data size for the elements of the vectors. It must be one of:
 8 encoded as size = 0b00
 16 encoded as size = 0b01
 32 encoded as size = 0b10
 64 encoded as size = 0b11.

<Qd>, <Qn>, <Qm> The destination vector and the operand vectors, for a quadword operation.

<Dd>, <Dn>, <Dm> The destination vector and the operand vectors, for a doubleword operation.

Operation

```
if ConditionPassed() then
    EncodingSpecificOperations(); CheckAdvSIMDEnabled();
    for r = 0 to regs-1
        for e = 0 to elements-1
            diff = Int(Elem[D[n+r],e,esize], unsigned) - Int(Elem[D[m+r],e,esize], unsigned);
            (Elem[D[d+r],e,esize], sat) = SatQ(diff, esize, unsigned);
            if sat then FPSCR.QC = '1';
```

Exceptions

Undefined Instruction.

A8.6.370 VRADDHN

Vector Rounding Add and Narrow, returning High Half adds corresponding elements in two quadword vectors, and places the most significant half of each result in a doubleword vector. The results are rounded. (For truncated results, see *VADDHN* on page A8-540.)

The operand elements can be 16-bit, 32-bit, or 64-bit integers. There is no distinction between signed and unsigned integers.

Encoding T1 / A1 Advanced SIMD

VRADDHN<c>.<dt> <Dd>, <Qn>, <Qm>

15	14	13	12	11	10	9	8	7	6	5	4	3	2	1	0	15	14	13	12	11	10	9	8	7	6	5	4	3	2	1	0
1	1	1	1	1	1	1	1	D	size	Vn		Vd		0	1	0	0	N	0	M	0	Vm									
31	30	29	28	27	26	25	24	23	22	21	20	19	18	17	16	15	14	13	12	11	10	9	8	7	6	5	4	3	2	1	0
1	1	1	1	0	0	1	1	1	D	size	Vn		Vd		0	1	0	0	N	0	M	0	Vm								

```

if size == '11' then SEE "Related encodings";
if Vn<0> == '1' || Vm<0> == '1' then UNDEFINED;
esize = 8 << UInt(size);  elements = 64 DIV esize;
d = UInt(D:Vd);  n = UInt(N:Vn);  m = UInt(M:Vm);
    
```

Related encodings See *Advanced SIMD data-processing instructions* on page A7-10

Assembler syntax

VRADDHN<c><q>.<dt> <Dd>, <Qn>, <Qm>

where:

<c><q> See *Standard assembler syntax fields* on page A8-7. An ARM VRADDHN instruction must be unconditional.

<dt> The data type for the elements of the operands. It must be one of:
 I16 size = 0b00
 I32 size = 0b01
 I64 size = 0b10.

<Dd>, <Qn>, <Qm> The destination vector and the operand vectors.

Operation

```
if ConditionPassed() then
    EncodingSpecificOperations(); CheckAdvSIMDEnabled();
    round_const = 1 << (esize-1);
    for e = 0 to elements-1
        result = Elem[Q[n>>1],e,2*esize] + Elem[Q[m>>1],e,2*esize] + round_const;
        Elem[D[d],e,esize] = result<2*esize-1:esize>;
```

Exceptions

Undefined Instruction.

A8.6.371 VRECPE

Vector Reciprocal Estimate finds an approximate reciprocal of each element in the operand vector, and places the results in the destination vector.

The operand and result elements are the same type, and can be 32-bit floating-point numbers, or 32-bit unsigned integers.

For details of the operation performed by this instruction see *Reciprocal estimate and step* on page A2-58.

Encoding T1 / A1 Advanced SIMD (F = 1 UNDEFINED in integer-only variants)

VRECPE<c>.<dt> <Qd>, <Qm>

VRECPE<c>.<dt> <Dd>, <Dm>

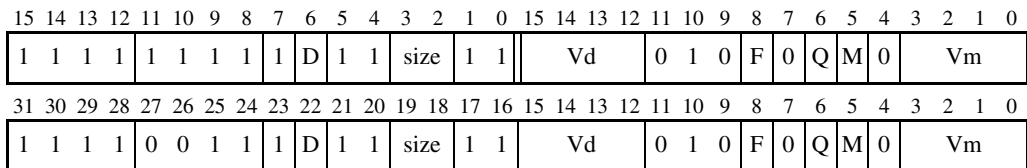

```

if Q == '1' && (Vd<0> == '1' || Vm<0> == '1') then UNDEFINED;
if size != '10' then UNDEFINED;
floating_point = (F == '1'); esize = 32; elements = 2;
d = UInt(D:Vd); m = UInt(M:Vm); regs = if Q == '0' then 1 else 2;
    
```

Assembler syntax

VRECPE<c><q>.<dt> <Qd>, <Qm> Encoded as Q = 1
 VRECPE<c><q>.<dt> <Dd>, <Dm> Encoded as Q = 0

where:

<c><q> See *Standard assembler syntax fields* on page A8-7. An ARM VRECPE instruction must be unconditional.

<dt> The data types for the elements of the vectors. It must be one of:
 U32 encoded as F = 0, size = 0b10
 F32 encoded as F = 1, size = 0b10.

<Qd>, <Qm> The destination vector and the operand vector, for a quadword operation.

<Dd>, <Dm> The destination vector and the operand vector, for a doubleword operation.

Operation

```
if ConditionPassed() then
  EncodingSpecificOperations(); CheckAdvSIMDEnabled();
  for r = 0 to regs-1
    for e = 0 to elements-1
      if floating_point then
        Elem[D[d+r],e,esize] = FPREcipEstimate(Elem[D[m+r],e,esize]);
      else
        Elem[D[d+r],e,esize] = UnsignedRecipEstimate(Elem[D[m+r],e,esize]);
```

Exceptions

Undefined Instruction.

Floating-point exceptions: Input Denormal, Invalid Operation, Underflow, and Division by Zero.

Newton-Raphson iteration

For details of the operation performed and how it can be used in a Newton-Raphson iteration to calculate the reciprocal of a number, see *Reciprocal estimate and step* on page A2-58.

A8.6.372 VRECPS

Vector Reciprocal Step multiplies the elements of one vector by the corresponding elements of another vector, subtracts each of the products from 2.0, and places the results into the elements of the destination vector.

The operand and result elements are 32-bit floating-point numbers.

For details of the operation performed by this instruction see *Reciprocal estimate and step* on page A2-58.

Encoding T1 / A1 Advanced SIMD (UNDEFINED in integer-only variant)

VRECPS<c>.F32 <Qd>, <Qn>, <Qm>

VRECPS<c>.F32 <Dd>, <Dn>, <Dm>

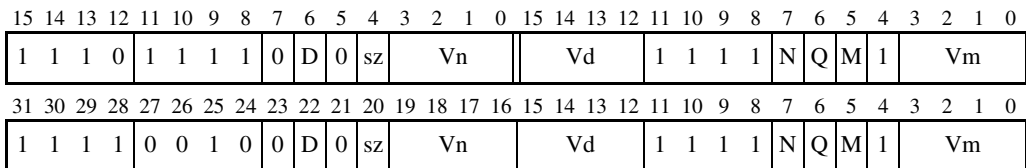

```

if Q == '1' && (Vd<0> == '1' || Vn<0> == '1' || Vm<0> == '1') then UNDEFINED;
if sz == '1' then UNDEFINED;
esize = 32; elements = 2;
d = UInt(D:Vd); n = UInt(N:Vn); m = UInt(M:Vm); regs = if Q == '0' then 1 else 2;
    
```

Assembler syntax

VRECPS<c><q>.F32 {<Qd>}, <Qn>, <Qm> Encoded as Q = 1
 VRECPS<c><q>.F32 {<Dd>}, <Dn>, <Dm> Encoded as Q = 0

where:

<c><q> See *Standard assembler syntax fields* on page A8-7. An ARM VRECPS instruction must be unconditional.

<Qd>, <Qn>, <Qm> The destination vector and the operand vectors for a quadword operation.

<Dd>, <Dn>, <Dm> The destination vector and the operand vectors for a doubleword operation.

Operation

```
if ConditionPassed() then
    EncodingSpecificOperations(); CheckAdvSIMDEnabled();
    for r = 0 to regs-1
        for e = 0 to elements-1
            Elem[D[d+r],e,esize] = FPRecipStep(Elem[D[n+r],e,esize], Elem[D[m+r],e,esize]);
```

Exceptions

Undefined Instruction.

Floating-point exceptions: Input Denormal, Invalid Operation, Overflow, Underflow, and Inexact.

Newton-Raphson iteration

For details of the operation performed and how it can be used in a Newton-Raphson iteration to calculate the reciprocal of a number, see *Reciprocal estimate and step* on page A2-58.

A8.6.373 VREV16, VREV32, VREV64

VREV16 (Vector Reverse in halfwords) reverses the order of 8-bit elements in each halfword of the vector, and places the result in the corresponding destination vector.

VREV32 (Vector Reverse in words) reverses the order of 8-bit or 16-bit elements in each word of the vector, and places the result in the corresponding destination vector.

VREV64 (Vector Reverse in doublewords) reverses the order of 8-bit, 16-bit, or 32-bit elements in each doubleword of the vector, and places the result in the corresponding destination vector.

There is no distinction between data types, other than size.

Encoding T1 / A1 Advanced SIMD

VREV<n><c>.<size> <Qd>, <Qm>

VREV<n><c>.<size> <Dd>, <Dm>

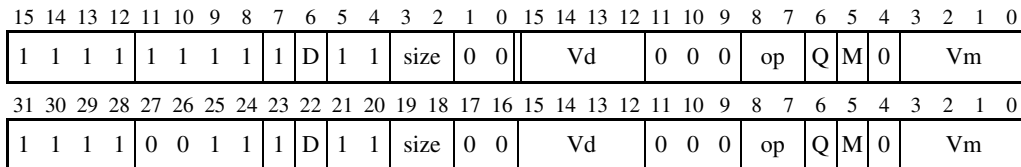

```

if UInt(op)+UInt(size) >= 3 then UNDEFINED;
if Q == '1' && (Vd<0> == '1' || Vm<0> == '1') then UNDEFINED;
esize = 8 << UInt(size); elements = 64 DIV esize;
groupsize = (1 << (3-UInt(op)-UInt(size))); // elements per reversing group: 2, 4 or 8
reverse_mask = (groupsize-1)<esize-1:0>; // EORing mask used for index calculations
d = UInt(D:Vd); m = UInt(M:Vm); regs = if Q == '0' then 1 else 2;
    
```

Figure A8-6 shows two examples of the operation of VREV.

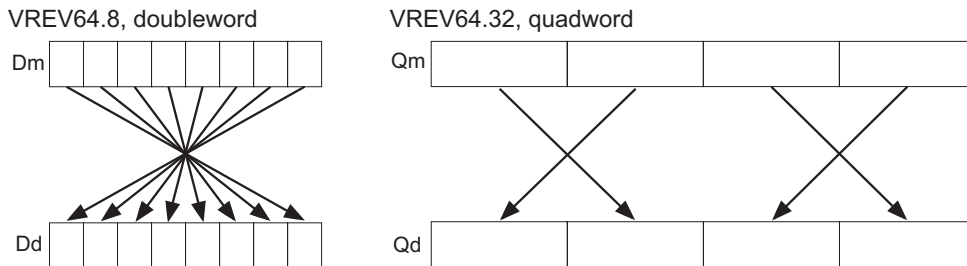

Figure A8-6 Examples of operation

Assembler syntax

VREV<n><c><q>.<size> <Qd>, <Qm> Encoded as Q = 1
 VREV<n><c><q>.<size> <Dd>, <Dm> Encoded as Q = 0

where:

<n> The size of the regions in which the vector elements are reversed. It must be one of:
 16 encoded as op = 0b10
 32 encoded as op = 0b01
 64 encoded as op = 0b00.

<c><q> See *Standard assembler syntax fields* on page A8-7. An ARM VREV instruction must be unconditional.

<size> The size of the vector elements. It must be one of:
 8 encoded as size = 0b00
 16 encoded as size = 0b01
 32 encoded as size = 0b10.
 <size> must specify a smaller size than <n>.

<Qd>, <Qm> The destination vector and the operand vector, for a quadword operation.

<Dd>, <Dm> The destination vector and the operand vector, for a doubleword operation.

If $op + size \geq 3$, the instruction is reserved.

Operation

```
if ConditionPassed() then
    EncodingSpecificOperations(); CheckAdvSIMDEnabled();
    bits(64) dest;

    for r = 0 to regs-1
        for e = 0 to elements-1
            // Calculate destination element index by bitwise EOR on source element index:
            e_bits = e<size-1:0>; d_bits = e_bits EOR reverse_mask; d = UInt(d_bits);
            Elem[dest,d,esize] = Elem[D[m+r],e,esize];
        D[d+r] = dest;
```

Exceptions

Undefined Instruction.

A8.6.374 VRHADD

Vector Rounding Halving Add adds corresponding elements in two vectors of integers, shifts each result right one bit, and places the final results in the destination vector.

The operand and result elements are all the same type, and can be any one of:

- 8-bit, 16-bit, or 32-bit signed integers
- 8-bit, 16-bit, or 32-bit unsigned integers.

The results of the halving operations are rounded (for truncated results see *VHADD*, *VHSUB* on page A8-600).

Encoding T1 / A1 Advanced SIMD

VRHADD<c> <Qd>, <Qn>, <Qm>

VRHADD<c> <Dd>, <Dn>, <Dm>

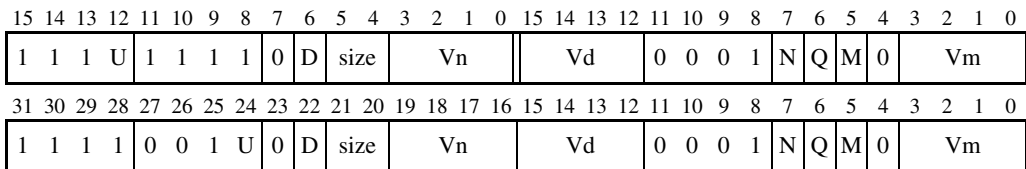

```

if Q == '1' && (Vd<0> == '1' || Vn<0> == '1' || Vm<0> == '1') then UNDEFINED;
if size == '11' then UNDEFINED;
unsigned = (U == '1');
esize = 8 << UInt(size); elements = 64 DIV esize;
d = UInt(D:Vd); n = UInt(N:Vn); m = UInt(M:Vm); regs = if Q == '0' then 1 else 2;
    
```

Assembler syntax

VRHADD<c><q>.<dt> {<Qd> ,} <Qn> , <Qm> Encoded as Q = 1
 VRHADD<c><q>.<dt> {<Dd> ,} <Dn> , <Dm> Encoded as Q = 0

where:

<c><q> See *Standard assembler syntax fields* on page A8-7. An ARM VRHADD instruction must be unconditional.

<dt> The data type for the elements of the vectors. It must be one of:

S8	encoded as size = 0b00, U = 0
S16	encoded as size = 0b01, U = 0
S32	encoded as size = 0b10, U = 0
U8	encoded as size = 0b00, U = 1
U16	encoded as size = 0b01, U = 1
U32	encoded as size = 0b10, U = 1.

<Qd>, <Qn>, <Qm> The destination vector and the operand vectors, for a quadword operation.

<Dd>, <Dn>, <Dm> The destination vector and the operand vectors, for a doubleword operation.

Operation

```
if ConditionPassed() then
    EncodingSpecificOperations(); CheckAdvSIMDEnabled();
    for r = 0 to regs-1
        for e = 0 to elements-1
            op1 = Int(Elem[D[n+r],e,esize], unsigned);
            op2 = Int(Elem[D[m+r],e,esize], unsigned);
            result = op1 + op2 + 1;
            Elem[D[d+r],e,esize] = result<esize:1>;
```

Exceptions

Undefined Instruction.

A8.6.375 VRSHL

Vector Rounding Shift Left takes each element in a vector, shifts them by a value from the least significant byte of the corresponding element of a second vector, and places the results in the destination vector. If the shift value is positive, the operation is a left shift. If the shift value is negative, it is a rounding right shift. (For a truncating shift, see *VSHL (register)* on page A8-752).

The first operand and result elements are the same data type, and can be any one of:

- 8-bit, 16-bit, 32-bit, or 64-bit signed integers
- 8-bit, 16-bit, 32-bit, or 64-bit unsigned integers.

The second operand is always a signed integer of the same size.

Encoding T1 / A1 Advanced SIMD

VRSHL<c>.<type><size> <Qd>, <Qm>, <Qn>

VRSHL<c>.<type><size> <Dd>, <Dm>, <Dn>

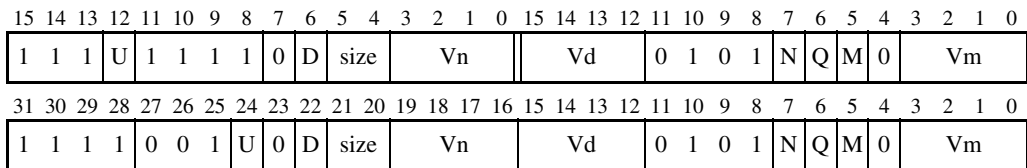

```

if Q == '1' && (Vd<0> == '1' || Vm<0> == '1' || Vn<0> == '1') then UNDEFINED;
unsigned = (U == '1');
esize = 8 << UInt(size); elements = 64 DIV esize;
d = UInt(D:Vd); m = UInt(M:Vm); n = UInt(N:Vn); regs = if Q == '0' then 1 else 2;
    
```

Assembler syntax

VRSHL<c><q>.<type><size> {<Qd>,<Qm>,<Qn> Encoded as Q = 1
 VRSHL<c><q>.<type><size> {<Dd>,<Dm>,<Dn> Encoded as Q = 0

where:

<c><q> See *Standard assembler syntax fields* on page A8-7. An ARM VRSHL instruction must be unconditional.

<type> The data type for the elements of the vectors. It must be one of:
 S signed, encoded as U = 0
 U unsigned, encoded as U = 1.

<size> The data size for the elements of the vectors. It must be one of:
 8 encoded as size = 0b00
 16 encoded as size = 0b01
 32 encoded as size = 0b10
 64 encoded as size = 0b11.

<Qd>, <Qm>, <Qn> The destination vector and the operand vectors, for a quadword operation.

<Dd>, <Dm>, <Dn> The destination vector and the operand vectors, for a doubleword operation.

Operation

```
if ConditionPassed() then
    EncodingSpecificOperations(); CheckAdvSIMDEnabled();
    for r = 0 to regs-1
        for e = 0 to elements-1
            shift = SInt(Elem[D[n+r],e,esize]<7:0>);
            round_const = 1 << (-shift-1); // 0 for left shift, 2^(n-1) for right shift
            result = (Int(Elem[D[m+r],e,esize], unsigned) + round_const) << shift;
            Elem[D[d+r],e,esize] = result<esize-1:0>;
```

Exceptions

Undefined Instruction.

A8.6.376 VRSHR

Vector Rounding Shift Right takes each element in a vector, right shifts them by an immediate value, and places the rounded results in the destination vector. For truncated results, see *VSHR* on page A8-756.

The operand and result elements must be the same size, and can be any one of:

- 8-bit, 16-bit, 32-bit, or 64-bit signed integers.
- 8-bit, 16-bit, 32-bit, or 64-bit unsigned integers.

Encoding T1 / A1 Advanced SIMD

VRSHR<c>.<type><size> <Qd>, <Qm>, #<imm>

VRSHR<c>.<type><size> <Dd>, <Dm>, #<imm>

15	14	13	12	11	10	9	8	7	6	5	4	3	2	1	0	15	14	13	12	11	10	9	8	7	6	5	4	3	2	1	0
1	1	1	U	1	1	1	1	1	D	imm6					Vd		0	0	1	0	L	Q	M	1	Vm						
31	30	29	28	27	26	25	24	23	22	21	20	19	18	17	16	15	14	13	12	11	10	9	8	7	6	5	4	3	2	1	0
1	1	1	1	0	0	1	U	1	D	imm6					Vd		0	0	1	0	L	Q	M	1	Vm						

```

if L:imm6 == '0000xxx' then SEE "Related encodings";
if Q == '1' && (Vd<0> == '1' || Vm<0> == '1') then UNDEFINED;
case L:imm6 of
  when '0001xxx' esize = 8; elements = 8; shift_amount = 16 - UInt(imm6);
  when '001xxxx' esize = 16; elements = 4; shift_amount = 32 - UInt(imm6);
  when '01xxxxx' esize = 32; elements = 2; shift_amount = 64 - UInt(imm6);
  when '1xxxxxx' esize = 64; elements = 1; shift_amount = 64 - UInt(imm6);
unsigned = (U == '1'); d = UInt(D:Vd); m = UInt(M:Vm); regs = if Q == '0' then 1 else 2;
    
```

Related encodings See *One register and a modified immediate value* on page A7-21

Assembler syntax

VRSHR<c><q>.<type><size> {<Qd>,<Qm>,<#imm>} Encoded as Q = 1
 VRSHR<c><q>.<type><size> {<Dd>,<Dm>,<#imm>} Encoded as Q = 0

where:

<c><q> See *Standard assembler syntax fields* on page A8-7. An ARM VRSHR instruction must be unconditional.

<type> The data type for the elements of the vectors. It must be one of:

- S signed, encoded as U = 0
- U unsigned, encoded as U = 1.

<size> The data size for the elements of the vectors. It must be one of:

- 8 Encoded as L = '0', imm6<5:3> = '001'. (8 – <imm>) is encoded in imm6<2:0>.
- 16 Encoded as L = '0', imm6<5:4> = '01'. (16 – <imm>) is encoded in imm6<3:0>.
- 32 Encoded as L = '0', imm6<5> = '1'. (32 – <imm>) is encoded in imm6<4:0>.
- 64 Encoded as L = '1'. (64 – <imm>) is encoded in imm6<5:0>.

<Qd>, <Qm> The destination vector, and the operand vector, for a quadword operation.

<Dd>, <Dm> The destination vector, and the operand vector, for a doubleword operation.

<imm> The immediate value, in the range 1 to <size>. See the description of <size> for how <imm> is encoded.

Operation

```

if ConditionPassed() then
    EncodingSpecificOperations(); CheckAdvSIMDEnabled();
    round_const = 1 << (shift_amount - 1);
    for r = 0 to regs-1
        for e = 0 to elements-1
            result = (Int(Elem[D[m+r],e,esize], unsigned) + round_const) >> shift_amount;
            Elem[D[d+r],e,esize] = result<esize-1:0>;
  
```

Exceptions

Undefined Instruction.

Pseudo-instructions

VRSHR.<type><size> <Qd>, <Qm>, #0 is a synonym for VMOV <Qd>, <Qm>
 VRSHR.<type><size> <Dd>, <Dm>, #0 is a synonym for VMOV <Dd>, <Dm>

For details see *VMOV (register)* on page A8-642.

A8.6.377 VRSHRN

Vector Rounding Shift Right and Narrow takes each element in a vector, right shifts them by an immediate value, and places the rounded results in the destination vector. For truncated results, see *VSHRN* on page A8-758.

The operand elements can be 16-bit, 32-bit, or 64-bit integers. There is no distinction between signed and unsigned integers. The destination elements are half the size of the source elements.

Encoding T1 / A1 Advanced SIMD

VRSHRN<c>.I<size> <Dd>, <Qm>, #<imm>

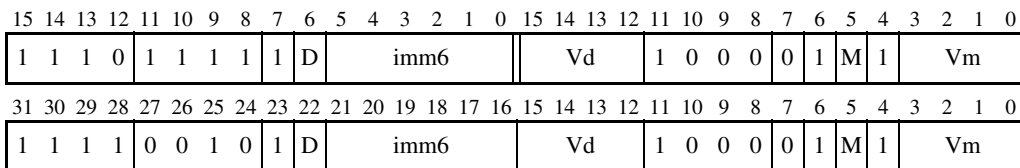

```

if imm6 == '000xxx' then SEE "Related encodings";
if Vm<0> == '1' then UNDEFINED;
case imm6 of
    when '001xxx' then esize = 8; elements = 8; shift_amount = 16 - UInt(imm6);
    when '01xxxx' then esize = 16; elements = 4; shift_amount = 32 - UInt(imm6);
    when '1xxxxx' then esize = 32; elements = 2; shift_amount = 64 - UInt(imm6);
d = UInt(D:Vd); m = UInt(M:Vm);
    
```

Related encodings See *One register and a modified immediate value* on page A7-21

Assembler syntax

VRSHRN<C><q>.I<size> <Dd>, <Qm>, #<imm>

where:

<C><q>	See <i>Standard assembler syntax fields</i> on page A8-7. An ARM VRSHRN instruction must be unconditional.
<size>	The data size for the elements of the vectors. It must be one of: 16 Encoded as imm6<5:3> = '001'. (8 – <imm>) is encoded in imm6<2:0>. 32 Encoded as imm6<5:4> = '01'. (16 – <imm>) is encoded in imm6<3:0>. 64 Encoded as imm6<5> = '1'. (32 – <imm>) is encoded in imm6<4:0>.
<Dd>, <Qm>	The destination vector, and the operand vector.
<imm>	The immediate value, in the range 1 to <size>/2. See the description of <size> for how <imm> is encoded.

Operation

```

if ConditionPassed() then
    EncodingSpecificOperations(); CheckAdvSIMDEnabled();
    round_const = 1 << (shift_amount-1);
    for e = 0 to elements-1
        result = LSR(Elem[Q[m]>>1],e,2*esize] + round_const, shift_amount);
        Elem[D[d],e,esize] = result<esize-1:0>;
  
```

Exceptions

Undefined Instruction.

Pseudo-instructions

VRSHRN.I<size> <Dd>, <Qm>, #0 is a synonym for VMOVN.I<size> <Dd>, <Qm>

For details see *VMOVN* on page A8-656.

A8.6.378 VRSQRTE

Vector Reciprocal Square Root Estimate finds an approximate reciprocal square root of each element in a vector, and places the results in a second vector.

The operand and result elements are the same type, and can be 32-bit floating-point numbers, or 32-bit unsigned integers.

For details of the operation performed by this instruction see *Reciprocal square root* on page A2-61.

Encoding T1 / A1 Advanced SIMD (F = 1 UNDEFINED in integer-only variants)

VRSQRTE<c>.<dt> <Qd>, <Qm>

VRSQRTE<c>.<dt> <Dd>, <Dm>

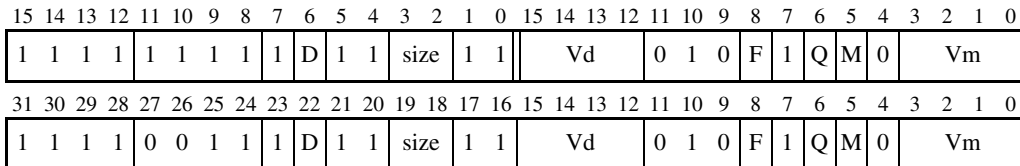

```

if Q == '1' && (Vd<0> == '1' || Vm<0> == '1') then UNDEFINED;
if size != '10' then UNDEFINED;
floating_point = (F == '1'); esize = 32; elements = 2;
d = UInt(D:Vd); m = UInt(M:Vm); regs = if Q == '0' then 1 else 2;
    
```

Assembler syntax

VRSQRTE<c><q>.<dt> <Qd>, <Qm> Encoded as Q = 1
 VRSQRTE<c><q>.<dt> <Dd>, <Dm> Encoded as Q = 0

where:

<c><q> See *Standard assembler syntax fields* on page A8-7. An ARM VRSQRTE instruction must be unconditional.

<dt> The data types for the elements of the vectors. It must be one of:
 U32 encoded as F = 0, size = 0b10
 F32 encoded as F = 1, size = 0b10.

<Qd>, <Qm> The destination vector and the operand vector, for a quadword operation.

<Dd>, <Dm> The destination vector and the operand vector, for a doubleword operation.

Operation

```

if ConditionPassed() then
    EncodingSpecificOperations(); CheckAdvSIMDEnabled();
    for r = 0 to regs-1
        for e = 0 to elements-1
            if floating_point then
                Elem[D[d+r],e,esize] = FPRSqrtEstimate(Elem[D[m+r],e,esize]);
            else
                Elem[D[d+r],e,esize] = UnsignedRSqrtEstimate(Elem[D[m+r],e,esize]);
  
```

Exceptions

Undefined Instruction.

Floating-point exceptions: Input Denormal, Invalid Operation, and Division by Zero.

Newton-Raphson iteration

For details of the operation performed and how it can be used in a Newton-Raphson iteration to calculate the reciprocal of the square root of a number, see *Reciprocal square root* on page A2-61.

A8.6.379 VRSQRTS

Vector Reciprocal Square Root Step multiplies the elements of one vector by the corresponding elements of another vector, subtracts each of the products from 3.0, divides these results by 2.0, and places the results into the elements of the destination vector.

The operand and result elements are 32-bit floating-point numbers.

For details of the operation performed by this instruction see *Reciprocal square root* on page A2-61.

Encoding T1 / A1 Advanced SIMD (UNDEFINED in integer-only variant)

VRSQRTS<c>.F32 <Qd>, <Qn>, <Qm>

VRSQRTS<c>.F32 <Dd>, <Dn>, <Dm>

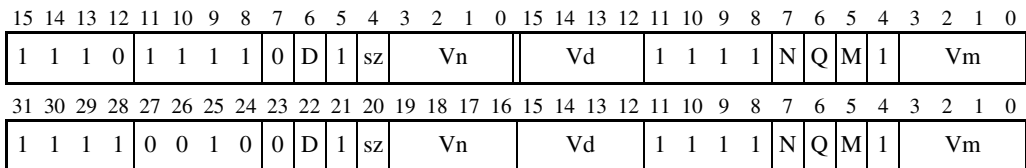

```

if Q == '1' && (Vd<0> == '1' || Vn<0> == '1' || Vm<0> == '1') then UNDEFINED;
if sz == '1' then UNDEFINED;
esize = 32; elements = 2;
d = UInt(D:Vd); n = UInt(N:Vn); m = UInt(M:Vm); regs = if Q == '0' then 1 else 2;
    
```

Assembler syntax

VRSQRTS<c><q>.F32 {<Qd>}, <Qn>, <Qm> Encoded as Q = 1, sz = 0

VRSQRTS<c><q>.F32 {<Dd>}, <Dn>, <Dm> Encoded as Q = 0, sz = 0

where:

<c><q> See *Standard assembler syntax fields* on page A8-7. An ARM VRSQRTS instruction must be unconditional.

<Qd>, <Qn>, <Qm> The destination vector and the operand vectors for a quadword operation.

<Dd>, <Dn>, <Dm> The destination vector and the operand vectors for a doubleword operation.

Operation

```

if ConditionPassed() then
    EncodingSpecificOperations(); CheckAdvSIMDEnabled();
    for r = 0 to regs-1
        for e = 0 to elements-1
            Elem[D[d+r],e,esize] = FPRSqrtStep(Elem[D[n+r],e,esize], Elem[D[m+r],e,esize]);

```

Exceptions

Undefined Instruction.

Floating-point exceptions: Input Denormal, Invalid Operation, Overflow, Underflow, and Inexact.

Newton-Raphson iteration

For details of the operation performed and how it can be used in a Newton-Raphson iteration to calculate the reciprocal of the square root of a number, see *Reciprocal square root* on page A2-61.

A8.6.380 VRSRA

Vector Rounding Shift Right and Accumulate takes each element in a vector, right shifts them by an immediate value, and accumulates the rounded results into the destination vector. (For truncated results, see VSRA on page A8-764.)

The operand and result elements must all be the same type, and can be any one of:

- 8-bit, 16-bit, 32-bit, or 64-bit signed integers.
- 8-bit, 16-bit, 32-bit, or 64-bit unsigned integers.

Encoding T1 / A1 Advanced SIMD

VRSRA<c>.<type><size> <Qd>, <Qm>, #<imm>

VRSRA<c>.<type><size> <Dd>, <Dm>, #<imm>

15	14	13	12	11	10	9	8	7	6	5	4	3	2	1	0	15	14	13	12	11	10	9	8	7	6	5	4	3	2	1	0
1	1	1	U	1	1	1	1	1	D	imm6					Vd		0	0	1	1	L	Q	M	1	Vm						
31	30	29	28	27	26	25	24	23	22	21	20	19	18	17	16	15	14	13	12	11	10	9	8	7	6	5	4	3	2	1	0
1	1	1	1	0	0	1	U	1	D	imm6					Vd		0	0	1	1	L	Q	M	1	Vm						

```

if L:imm6 == '0000xxx' then SEE "Related encodings";
if Q == '1' && (Vd<0> == '1' || Vm<0> == '1') then UNDEFINED;
case L:imm6 of
  when '0001xxx' esize = 8; elements = 8; shift_amount = 16 - UInt(imm6);
  when '001xxxx' esize = 16; elements = 4; shift_amount = 32 - UInt(imm6);
  when '01xxxxx' esize = 32; elements = 2; shift_amount = 64 - UInt(imm6);
  when '1xxxxxx' esize = 64; elements = 1; shift_amount = 64 - UInt(imm6);
unsigned = (U == '1'); d = UInt(D:Vd); m = UInt(M:Vm); regs = if Q == '0' then 1 else 2;
    
```

Related encodings See *One register and a modified immediate value* on page A7-21

Assembler syntax

VRSRA<c><q>.<type><size> {<Qd>,<Qm>,<#imm>} Encoded as Q = 1
 VRSRA<c><q>.<type><size> {<Dd>,<Dm>,<#imm>} Encoded as Q = 0

where:

<c><q> See *Standard assembler syntax fields* on page A8-7. An ARM VRSRA instruction must be unconditional.

<type> The data type for the elements of the vectors. It must be one of:
 S signed, encoded as U = 0
 U unsigned, encoded as U = 1.

<size> The data size for the elements of the vectors. It must be one of:
 8 Encoded as L = '0', imm6<5:3> = '001'. (8 – <imm>) is encoded in imm6<2:0>.
 16 Encoded as L = '0', imm6<5:4> = '01'. (16 – <imm>) is encoded in imm6<3:0>.
 32 Encoded as L = '0', imm6<5> = '1'. (32 – <imm>) is encoded in imm6<4:0>.
 64 Encoded as L = '1'. (64 – <imm>) is encoded in imm6<5:0>.

<Qd>, <Qm> The destination vector, and the operand vector, for a quadword operation.

<Dd>, <Dm> The destination vector, and the operand vector, for a doubleword operation.

<imm> The immediate value, in the range 1 to <size>. See the description of <size> for how <imm> is encoded.

Operation

```
if ConditionPassed() then
    EncodingSpecificOperations(); CheckAdvSIMDEnabled();
    round_const = 1 << (shift_amount - 1);
    for r = 0 to regs-1
        for e = 0 to elements-1
            result = (Int(Elem[D[m+r],e,esize], unsigned) + round_const) >> shift_amount;
            Elem[D[d+r],e,esize] = Elem[D[d+r],e,esize] + result;
```

Exceptions

Undefined Instruction.

A8.6.381 VRSUBHN

Vector Rounding Subtract and Narrow, returning High Half subtracts the elements of one quadword vector from the corresponding elements of another quadword vector takes the most significant half of each result, and places the final results in a doubleword vector. The results are rounded. (For truncated results, see *VSUBHN* on page A8-792.)

The operand elements can be 16-bit, 32-bit, or 64-bit integers. There is no distinction between signed and unsigned integers.

Encoding T1 / A1 Advanced SIMD

VRSUBHN<c>.<dt> <Dd>, <Qn>, <Qm>

15	14	13	12	11	10	9	8	7	6	5	4	3	2	1	0	15	14	13	12	11	10	9	8	7	6	5	4	3	2	1	0
1	1	1	1	1	1	1	1	D	size	Vn		Vd		0	1	1	0	N	0	M	0	Vm									
31	30	29	28	27	26	25	24	23	22	21	20	19	18	17	16	15	14	13	12	11	10	9	8	7	6	5	4	3	2	1	0
1	1	1	1	0	0	1	1	1	D	size	Vn		Vd		0	1	1	0	N	0	M	0	Vm								

```

if size == '11' then SEE "Related encodings";
if Vn<0> == '1' || Vm<0> == '1' then UNDEFINED;
esize = 8 << UInt(size); elements = 64 DIV esize;
d = UInt(D:Vd); n = UInt(N:Vn); m = UInt(M:Vm);
    
```

Related encodings See *Advanced SIMD data-processing instructions* on page A7-10

Assembler syntax

VRSUBHN<c><q>.<dt> <Dd>, <Qn>, <Qm>

where:

<c><q> See *Standard assembler syntax fields* on page A8-7. An ARM VRSUBHN instruction must be unconditional.

<dt> The data type for the elements of the operands. It must be one of:
 I16 size = 0b00
 I32 size = 0b01
 I64 size = 0b10.

<Dd>, <Qn>, <Qm> The destination vector and the operand vectors.

Operation

```
if ConditionPassed() then
    EncodingSpecificOperations(); CheckAdvSIMDEnabled();
    round_const = 1 << (esize-1);
    for e = 0 to elements-1
        result = Elem[Q[n>>1],e,2*esize] - Elem[Q[m>>1],e,2*esize] + round_const;
        Elem[D[d],e,esize] = result<2*esize-1:esize>;
```

Exceptions

Undefined Instruction.

A8.6.382 VSHL (immediate)

Vector Shift Left (immediate) takes each element in a vector of integers, left shifts them by an immediate value, and places the results in the destination vector.

Bits shifted out of the left of each element are lost.

The elements must all be the same size, and can be 8-bit, 16-bit, 32-bit, or 64-bit integers. There is no distinction between signed and unsigned integers.

Encoding T1 / A1 Advanced SIMD

VSHL<C>.I<size> <Qd>, <Qm>, #<imm>

VSHL<C>.I<size> <Dd>, <Dm>, #<imm>

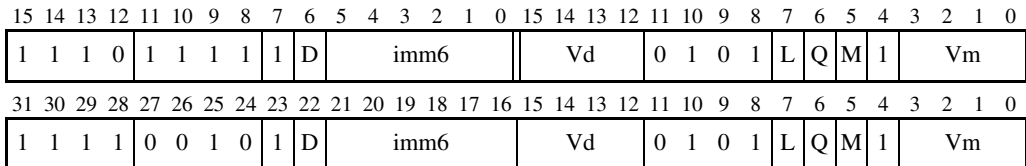

```

if L:imm6 == '0000xxx' then SEE "Related encodings";
if Q == '1' && (Vd<0> == '1' || Vm<0> == '1') then UNDEFINED;
case L:imm6 of
  when '0001xxx' esize = 8; elements = 8; shift_amount = UInt(imm6) - 8;
  when '001xxxx' esize = 16; elements = 4; shift_amount = UInt(imm6) - 16;
  when '01xxxxx' esize = 32; elements = 2; shift_amount = UInt(imm6) - 32;
  when '1xxxxxx' esize = 64; elements = 1; shift_amount = UInt(imm6);
d = UInt(D:Vd); m = UInt(M:Vm); regs = if Q == '0' then 1 else 2;

```

Related encodings See *One register and a modified immediate value* on page A7-21

Assembler syntax

VSHL<c><q>.I<size> {<Qd>,<Qm>}, #<imm> Encoded as Q = 1
 VSHL<c><q>.I<size> {<Dd>,<Dm>}, #<imm> Encoded as Q = 0

where:

<c><q> See *Standard assembler syntax fields* on page A8-7. An ARM VSHL instruction must be unconditional.

<size> The data size for the elements of the vectors. It must be one of:
 8 Encoded as L = '0', imm6<5:3> = '001'. <imm> is encoded in imm6<2:0>.
 16 Encoded as L = '0', imm6<5:4> = '01'. <imm> is encoded in imm6<3:0>.
 32 Encoded as L = '0', imm6<5> = '1'. <imm> is encoded in imm6<4:0>.
 64 Encoded as L = '1'. <imm> is encoded in imm6<5:0>.

<Qd>, <Qm> The destination vector, and the operand vector, for a quadword operation.

<Dd>, <Dm> The destination vector, and the operand vector, for a doubleword operation.

<imm> The immediate value, in the range 0 to <size>-1. See the description of <size> for how <imm> is encoded.

Operation

```
if ConditionPassed() then
    EncodingSpecificOperations(); CheckAdvSIMDEnabled();
    for r = 0 to regs-1
        for e = 0 to elements-1
            Elem[D[d+r],e,esize] = LSL(Elem[D[m+r],e,esize], shift_amount);
```

Exceptions

Undefined Instruction.

A8.6.383 VSHL (register)

Vector Shift Left (register) takes each element in a vector, shifts them by a value from the least significant byte of the corresponding element of a second vector, and places the results in the destination vector. If the shift value is positive, the operation is a left shift. If the shift value is negative, it is a truncating right shift. (For a rounding shift, see *VRSHL* on page A8-736).

The first operand and result elements are the same data type, and can be any one of:

- 8-bit, 16-bit, 32-bit, or 64-bit signed integers
- 8-bit, 16-bit, 32-bit, or 64-bit unsigned integers.

The second operand is always a signed integer of the same size.

Encoding T1 / A1 Advanced SIMD

VSHL<C>.I<size> <Qd>, <Qm>, <Qn>

VSHL<C>.I<size> <Dd>, <Dm>, <Dn>

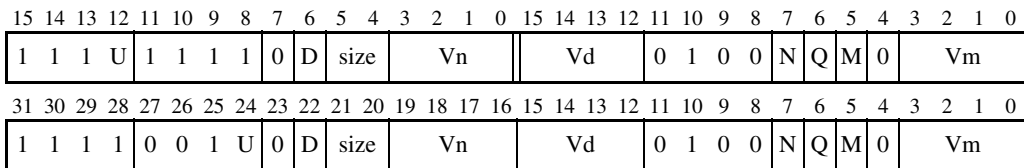

```

if Q == '1' && (Vd<0> == '1' || Vm<0> == '1' || Vn<0> == '1') then UNDEFINED;
unsigned = (U == '1');
esize = 8 << UInt(size); elements = 64 DIV esize;
d = UInt(D:Vd); m = UInt(M:Vm); n = UInt(N:Vn); regs = if Q == '0' then 1 else 2;
    
```

Assembler syntax

VSHL<c><q>.<type><size> {<Qd>,<Qm>,<Qn> Encoded as Q = 1
 VSHL<c><q>.<type><size> {<Dd>,<Dm>,<Dn> Encoded as Q = 0

where:

<c><q> See *Standard assembler syntax fields* on page A8-7. An ARM VSHL instruction must be unconditional.

<type> The data type for the elements of the vectors. It must be one of:
 S signed, encoded as U = 0
 U unsigned, encoded as U = 1.

<size> The data size for the elements of the vectors. It must be one of:
 8 encoded as size = 0b00
 16 encoded as size = 0b01
 32 encoded as size = 0b10
 64 encoded as size = 0b11.

<Qd>, <Qm>, <Qn> The destination vector and the operand vectors, for a quadword operation.

<Dd>, <Dm>, <Dn> The destination vector and the operand vectors, for a doubleword operation.

Operation

```
if ConditionPassed() then
    EncodingSpecificOperations(); CheckAdvSIMDEnabled();
    for r = 0 to regs-1
        for e = 0 to elements-1
            shift = SInt(Elm[D[n+r],e,esize]<7:0>);
            result = Int(Elm[D[m+r],e,esize], unsigned) << shift;
            Elm[D[d+r],e,esize] = result<esize-1:0>;
```

Exceptions

Undefined Instruction.

A8.6.384 VSHLL

Vector Shift Left Long takes each element in a doubleword vector, left shifts them by an immediate value, and places the results in a quadword vector.

The operand elements can be:

- 8-bit, 16-bit, or 32-bit signed integers
- 8-bit, 16-bit, or 32-bit unsigned integers
- 8-bit, 16-bit, or 32-bit untyped integers (maximum shift only).

The result elements are twice the length of the operand elements.

Encoding T1 / A1 Advanced SIMD

VSHLL<c>.<type><size> <Qd>, <Dm>, #<imm> (0 < <imm> < <size>)

15	14	13	12	11	10	9	8	7	6	5	4	3	2	1	0	15	14	13	12	11	10	9	8	7	6	5	4	3	2	1	0
1	1	1	U	1	1	1	1	1	D	imm6				Vd		1	0	1	0	0	0	M	1	Vm							
31	30	29	28	27	26	25	24	23	22	21	20	19	18	17	16	15	14	13	12	11	10	9	8	7	6	5	4	3	2	1	0
1	1	1	1	0	0	1	U	1	D	imm6				Vd		1	0	1	0	0	0	M	1	Vm							

if imm6 == '000xxx' then SEE "Related encodings";

if Vd<0> == '1' then UNDEFINED;

case imm6 of

when '001xxx' esize = 8; elements = 8; shift_amount = UInt(imm6) - 8;

when '01xxxx' esize = 16; elements = 4; shift_amount = UInt(imm6) - 16;

when '1xxxxx' esize = 32; elements = 2; shift_amount = UInt(imm6) - 32;

if shift_amount == 0 then SEE VMOVL;

unsigned = (U == '1'); d = UInt(D:Vd); m = UInt(M:Vm);

Encoding T2 / A2 Advanced SIMD

VSHLL<c>.<type><size> <Qd>, <Dm>, #<imm> (<imm> == <size>)

15	14	13	12	11	10	9	8	7	6	5	4	3	2	1	0	15	14	13	12	11	10	9	8	7	6	5	4	3	2	1	0
1	1	1	1	1	1	1	1	1	D	1	1	size	1	0	Vd		0	0	1	1	0	0	M	0	Vm						
31	30	29	28	27	26	25	24	23	22	21	20	19	18	17	16	15	14	13	12	11	10	9	8	7	6	5	4	3	2	1	0
1	1	1	1	0	0	1	1	1	D	1	1	size	1	0	Vd		0	0	1	1	0	0	M	0	Vm						

if size == '11' || Vd<0> == '1' then UNDEFINED;

esize = 8 << UInt(size); shift_amount = esize;

unsigned = FALSE; // Or TRUE without change of functionality

d = UInt(D:Vd); m = UInt(M:Vm);

Related encodings See *One register and a modified immediate value* on page A7-21

Assembler syntax

VSHLL<c><q>.<type><size> <Qd>, <Dm>, #<imm>

where:

<c><q>	See <i>Standard assembler syntax fields</i> on page A8-7. An ARM VSHLL instruction must be unconditional.
<type>	The data type for the elements of the operand. It must be one of: S encoded as U = 0 in encoding T1 / A1 U encoded as U = 1 in encoding T1 / A1 I available only in encoding T2 / A2.
<size>	The data size for the elements of the operand. It must be one of: 8 encoded as imm6<5:3> = '001' or size = '00' 16 encoded as imm6<5:4> = '01' or size = '01' 32 encoded as imm6<5> = '1' or size = '10'.
<Qd>, <Dm>	The destination vector and the operand vector.
<imm>	The immediate value. <imm> must lie in the range 1 to <size>: <ul style="list-style-type: none"> • if <size> = <imm>, encoding is T2 / A2 • if <size> = 8, <imm> is encoded in imm6<2:0> • if <size> = 16, <imm> is encoded in imm6<3:0> • if <size> = 32, <imm> is encoded in imm6<4:0>.

Operation

```

if ConditionPassed() then
    EncodingSpecificOperations(); CheckAdvSIMDEnabled();
    for e = 0 to elements-1
        result = Int(Elem[D[m],e,esize], unsigned) << shift_amount;
        Elem[Q[d>>1],e,2*esize] = result<2*esize-1:0>;

```

Exceptions

Undefined Instruction.

A8.6.385 VSHR

Vector Shift Right takes each element in a vector, right shifts them by an immediate value, and places the truncated results in the destination vector. For rounded results, see *VRSHR* on page A8-738.

The operand and result elements must be the same size, and can be any one of:

- 8-bit, 16-bit, 32-bit, or 64-bit signed integers.
- 8-bit, 16-bit, 32-bit, or 64-bit unsigned integers.

Encoding T1 / A1 Advanced SIMD

VSHR<c>.<type><size> <Qd>, <Qm>, #<imm>

VSHR<c>.<type><size> <Dd>, <Dm>, #<imm>

15	14	13	12	11	10	9	8	7	6	5	4	3	2	1	0	15	14	13	12	11	10	9	8	7	6	5	4	3	2	1	0
1	1	1	U	1	1	1	1	1	D	imm6						Vd		0	0	0	0	L	Q	M	1	Vm					
31	30	29	28	27	26	25	24	23	22	21	20	19	18	17	16	15	14	13	12	11	10	9	8	7	6	5	4	3	2	1	0
1	1	1	1	0	0	1	U	1	D	imm6						Vd		0	0	0	0	L	Q	M	1	Vm					

```

if L:imm6 == '0000xxx' then SEE "Related encodings";
if Q == '1' && (Vd<0> == '1' || Vm<0> == '1') then UNDEFINED;
case L:imm6 of
  when '0001xxx' esize = 8; elements = 8; shift_amount = 16 - UInt(imm6);
  when '001xxxx' esize = 16; elements = 4; shift_amount = 32 - UInt(imm6);
  when '01xxxxx' esize = 32; elements = 2; shift_amount = 64 - UInt(imm6);
  when '1xxxxxx' esize = 64; elements = 1; shift_amount = 64 - UInt(imm6);
unsigned = (U == '1'); d = UInt(D:Vd); m = UInt(M:Vm); regs = if Q == '0' then 1 else 2;

```

Related encodings See *One register and a modified immediate value* on page A7-21

Assembler syntax

VSHR<c><q>.<type><size> {<Qd>,<Qm>,<#imm>} Encoded as Q = 1
 VSHR<c><q>.<type><size> {<Dd>,<Dm>,<#imm>} Encoded as Q = 0

where:

<c><q> See *Standard assembler syntax fields* on page A8-7. An ARM VSHR instruction must be unconditional.

<type> The data type for the elements of the vectors. It must be one of:
 S signed, encoded as U = 0
 U unsigned, encoded as U = 1.

<size> The data size for the elements of the vectors. It must be one of:
 8 Encoded as L = '0', imm6<5:3> = '001'. (8 – <imm>) is encoded in imm6<2:0>.
 16 Encoded as L = '0', imm6<5:4> = '01'. (16 – <imm>) is encoded in imm6<3:0>.
 32 Encoded as L = '0', imm6<5> = '1'. (32 – <imm>) is encoded in imm6<4:0>.
 64 Encoded as L = '1'. (64 – <imm>) is encoded in imm6<5:0>.

<Qd>, <Qm> The destination vector, and the operand vector, for a quadword operation.

<Dd>, <Dm> The destination vector, and the operand vector, for a doubleword operation.

<imm> The immediate value, in the range 1 to <size>. See the description of <size> for how <imm> is encoded.

Operation

```
if ConditionPassed() then
    EncodingSpecificOperations(); CheckAdvSIMDEnabled();
    for r = 0 to regs-1
        for e = 0 to elements-1
            result = Int(Elem[D[m+r],e,esize], unsigned) >> shift_amount;
            Elem[D[d+r],e,esize] = result<esize-1:0>;
```

Exceptions

Undefined Instruction.

Pseudo-instructions

VSHR.<type><size> <Qd>, <Qm>, #0 is a synonym for VMOV <Qd>, <Qm>
 VSHR.<type><size> <Dd>, <Dm>, #0 is a synonym for VMOV <Dd>, <Dm>

A8.6.386 VSHRN

Vector Shift Right Narrow takes each element in a vector, right shifts them by an immediate value, and places the truncated results in the destination vector. For rounded results, see *VRSHRN* on page A8-740.

The operand elements can be 16-bit, 32-bit, or 64-bit integers. There is no distinction between signed and unsigned integers. The destination elements are half the size of the source elements.

Encoding T1 / A1 Advanced SIMD

VSHRN<c>.*I*<size> <Dd>, <Qm>, #<imm>

15	14	13	12	11	10	9	8	7	6	5	4	3	2	1	0	15	14	13	12	11	10	9	8	7	6	5	4	3	2	1	0
1	1	1	0	1	1	1	1	1	D	imm6					Vd		1	0	0	0	0	0	M	1	Vm						
31	30	29	28	27	26	25	24	23	22	21	20	19	18	17	16	15	14	13	12	11	10	9	8	7	6	5	4	3	2	1	0
1	1	1	1	0	0	1	0	1	D	imm6					Vd		1	0	0	0	0	0	M	1	Vm						

if imm6 == '000xxx' then SEE "Related encodings";

if Vm<0> == '1' then UNDEFINED;

case imm6 of

 when '001xxx' esize = 8; elements = 8; shift_amount = 16 - UInt(imm6);

 when '01xxxx' esize = 16; elements = 4; shift_amount = 32 - UInt(imm6);

 when '1xxxxx' esize = 32; elements = 2; shift_amount = 64 - UInt(imm6);

d = UInt(D:Vd); m = UInt(M:Vm);

Related encodings See *One register and a modified immediate value* on page A7-21

Assembler syntax

VSHRN<c><q>.I<size> <Dd>, <Qm>, #<imm>

where:

<c><q>	See <i>Standard assembler syntax fields</i> on page A8-7. An ARM VSHRN instruction must be unconditional.
<size>	The data size for the elements of the vectors. It must be one of: 16 Encoded as imm6<5:3> = '001'. (8 – <imm>) is encoded in imm6<2:0>. 32 Encoded as imm6<5:4> = '01'. (16 – <imm>) is encoded in imm6<3:0>. 64 Encoded as imm6<5> = '1'. (32 – <imm>) is encoded in imm6<4:0>.
<Dd>, <Qm>	The destination vector, and the operand vector.
<imm>	The immediate value, in the range 1 to <size>/2. See the description of <size> for how <imm> is encoded.

Operation

```
if ConditionPassed() then
    EncodingSpecificOperations(); CheckAdvSIMDEnabled();
    for e = 0 to elements-1
        result = LSR(Elem[Q[m]>>1],e,2*esize], shift_amount);
        Elem[D[d],e,esize] = result<esize-1:0>;
```

Exceptions

Undefined Instruction.

Pseudo-instructions

VSHRN.I<size> <Dd>, <Qm>, #0 is a synonym for VMOVN.I<size> <Dd>, <Qm>

For details see *VMOVN* on page A8-656.

A8.6.387 VSLI

Vector Shift Left and Insert takes each element in the operand vector, left shifts them by an immediate value, and inserts the results in the destination vector. Bits shifted out of the left of each element are lost.

The elements must all be the same size, and can be 8-bit, 16-bit, 32-bit, or 64-bit. There is no distinction between data types.

Encoding T1 / A1 Advanced SIMD

VSLI<c>.<size> <Qd>, <Qm>, #<imm>

VSLI<c>.<size> <Dd>, <Dm>, #<imm>

15	14	13	12	11	10	9	8	7	6	5	4	3	2	1	0	15	14	13	12	11	10	9	8	7	6	5	4	3	2	1	0
1	1	1	1	1	1	1	1	1	D	imm6						Vd			0	1	0	1	L	Q	M	1	Vm				
31	30	29	28	27	26	25	24	23	22	21	20	19	18	17	16	15	14	13	12	11	10	9	8	7	6	5	4	3	2	1	0
1	1	1	1	0	0	1	1	1	1	D	imm6						Vd			0	1	0	1	L	Q	M	1	Vm			

if L:imm6 == '0000xxx' then SEE "Related encodings";

if Q == '1' && (Vd<0> == '1' || Vm<0> == '1') then UNDEFINED;

case L:imm6 of

 when '0001xxx' esize = 8; elements = 8; shift_amount = UInt(imm6) - 8;

 when '001xxxx' esize = 16; elements = 4; shift_amount = UInt(imm6) - 16;

 when '01xxxxx' esize = 32; elements = 2; shift_amount = UInt(imm6) - 32;

 when '1xxxxxx' esize = 64; elements = 1; shift_amount = UInt(imm6);

d = UInt(D:Vd); m = UInt(M:Vm); regs = if Q == '0' then 1 else 2;

Related encodings See *One register and a modified immediate value* on page A7-21

Assembler syntax

VSLI<c><q>.<size> {<Qd>}, <Qm>, #<imm> Encoded as Q = 1
 VSLI<c><q>.<size> {<Dd>}, <Dm>, #<imm> Encoded as Q = 0

where:

<c><q> See *Standard assembler syntax fields* on page A8-7. An ARM VSLI instruction must be unconditional.

<size> The data size for the elements of the vectors. It must be one of:
 8 Encoded as L = '0', imm6<5:3> = '001'. <imm> is encoded in imm6<2:0>.
 16 Encoded as L = '0', imm6<5:4> = '01'. <imm> is encoded in imm6<3:0>.
 32 Encoded as L = '0', imm6<5> = '1'. <imm> is encoded in imm6<4:0>.
 64 Encoded as L = '1'. <imm> is encoded in imm6<5:0>.

<Qd>, <Qm> The destination vector, and the operand vector, for a quadword operation.

<Dd>, <Dm> The destination vector, and the operand vector, for a doubleword operation.

<imm> The immediate value, in the range 0 to <size>-1. See the description of <size> for how <imm> is encoded.

Operation

```
if ConditionPassed() then
    EncodingSpecificOperations(); CheckAdvSIMDEnabled();
    mask = LSL(Ones(esize), shift_amount);
    for r = 0 to regs-1
        for e = 0 to elements-1
            shifted_op = LSL(Elem[D[m+r],e,esize], shift_amount);
            Elem[D[d+r],e,esize] = (Elem[D[d+r],e,esize] AND NOT(mask)) OR shifted_op;
```

Exceptions

Undefined Instruction.

A8.6.388 VSQRT

This instruction calculates the square root of the value in a floating-point register and writes the result to another floating-point register.

Encoding T1 / A1 VFPv2, VFPv3 (sz = 1 UNDEFINED in single-precision only variants)

VSQRT<c>.F64 <Dd>, <Dm>

VSQRT<c>.F32 <Sd>, <Sm>

15	14	13	12	11	10	9	8	7	6	5	4	3	2	1	0	15	14	13	12	11	10	9	8	7	6	5	4	3	2	1	0
1	1	1	0	1	1	1	0	1	D	1	1	0	0	0	1	Vd	1	0	1	sz	1	1	M	0	Vm						
31	30	29	28	27	26	25	24	23	22	21	20	19	18	17	16	15	14	13	12	11	10	9	8	7	6	5	4	3	2	1	0
cond		1	1	1	0	1	D	1	1	0	0	0	1	Vd	1	0	1	sz	1	1	M	0	Vm								

if FPSCR.LEN != '000' || FPSCR.STRIDE != '00' then SEE "VFP vectors";

dp_operation = (sz == '1');

d = if dp_operation then UInt(D:Vd) else UInt(Vd:D);

m = if dp_operation then UInt(M:Vm) else UInt(Vm:M);

VFP vectors This instruction can operate on VFP vectors under control of the FPSCR.LEN and FPSCR.STRIDE bits. For details see Appendix F *VFP Vector Operation Support*.

Assembler syntax

VSQRT<c><q>.F64 <Dd>, <Dm> Encoded as sz = 1
 VSQRT<c><q>.F32 <Sd>, <Sm> Encoded as sz = 0

where:

<c><q> See *Standard assembler syntax fields* on page A8-7.
 <Dd>, <Dm> The destination vector and the operand vector, for a double-precision operation.
 <Sd>, <Sm> The destination vector and the operand vector, for a single-precision operation.

Operation

```
if ConditionPassed() then
    EncodingSpecificOperations(); CheckVFPEnabled(TRUE);
    if dp_operation then
        D[d] = FPSqrt(D[m]);
    else
        S[d] = FPSqrt(S[m]);
```

Exceptions

Undefined Instruction.

Floating-point exceptions: Invalid Operation, Inexact, Input Denormal.

A8.6.389 VSRA

Vector Shift Right and Accumulate takes each element in a vector, right shifts them by an immediate value, and accumulates the truncated results into the destination vector. (For rounded results, see *VRSRA* on page A8-746.)

The operand and result elements must all be the same type, and can be any one of:

- 8-bit, 16-bit, 32-bit, or 64-bit signed integers.
- 8-bit, 16-bit, 32-bit, or 64-bit unsigned integers.

Encoding T1 / A1 Advanced SIMD

VSRA<c>.<type><size> <Qd>, <Qm>, #<imm>

VSRA<c>.<type><size> <Dd>, <Dm>, #<imm>

15	14	13	12	11	10	9	8	7	6	5	4	3	2	1	0	15	14	13	12	11	10	9	8	7	6	5	4	3	2	1	0
1	1	1	U	1	1	1	1	1	D	imm6						Vd			0	0	0	1	L	Q	M	1	Vm				
31	30	29	28	27	26	25	24	23	22	21	20	19	18	17	16	15	14	13	12	11	10	9	8	7	6	5	4	3	2	1	0
1	1	1	1	0	0	1	U	1	D	imm6						Vd			0	0	0	1	L	Q	M	1	Vm				

if L:imm6 == '0000xxx' then SEE "Related encodings";

if Q == '1' && (Vd<0> == '1' || Vm<0> == '1') then UNDEFINED;

case L:imm6 of

 when '0001xxx' esize = 8; elements = 8; shift_amount = 16 - UInt(imm6);

 when '001xxxx' esize = 16; elements = 4; shift_amount = 32 - UInt(imm6);

 when '01xxxxx' esize = 32; elements = 2; shift_amount = 64 - UInt(imm6);

 when '1xxxxxx' esize = 64; elements = 1; shift_amount = 64 - UInt(imm6);

unsigned = (U == '1'); d = UInt(D:Vd); m = UInt(M:Vm); regs = if Q == '0' then 1 else 2;

Related encodings See *One register and a modified immediate value* on page A7-21

Assembler syntax

VSRA<c><q>.<type><size> {<Qd>,<Qm>,<#imm>} Encoded as Q = 1
 VSRA<c><q>.<type><size> {<Dd>,<Dm>,<#imm>} Encoded as Q = 0

where:

<c><q> See *Standard assembler syntax fields* on page A8-7. An ARM VSRA instruction must be unconditional.

<type> The data type for the elements of the vectors. It must be one of:
 S signed, encoded as U = 0
 U unsigned, encoded as U = 1.

<size> The data size for the elements of the vectors. It must be one of:
 8 Encoded as L = '0', imm6<5:3> = '001'. (8 – <imm>) is encoded in imm6<2:0>.
 16 Encoded as L = '0', imm6<5:4> = '01'. (16 – <imm>) is encoded in imm6<3:0>.
 32 Encoded as L = '0', imm6<5> = '1'. (32 – <imm>) is encoded in imm6<4:0>.
 64 Encoded as L = '1'. (64 – <imm>) is encoded in imm6<5:0>.

<Qd>, <Qm> The destination vector, and the operand vector, for a quadword operation.

<Dd>, <Dm> The destination vector, and the operand vector, for a doubleword operation.

<imm> The immediate value, in the range 1 to <size>. See the description of <size> for how <imm> is encoded.

Operation

```
if ConditionPassed() then
    EncodingSpecificOperations(); CheckAdvSIMDEnabled();
    for r = 0 to regs-1
        for e = 0 to elements-1
            result = Int(Elem[D[m+r],e,esize], unsigned) >> shift_amount;
            Elem[D[d+r],e,esize] = Elem[D[d+r],e,esize] + result;
```

Exceptions

Undefined Instruction.

A8.6.390 VSRI

Vector Shift Right and Insert takes each element in the operand vector, right shifts them by an immediate value, and inserts the results in the destination vector. Bits shifted out of the right of each element are lost.

The elements must all be the same size, and can be 8-bit, 16-bit, 32-bit, or 64-bit. There is no distinction between data types.

Encoding T1 / A1 Advanced SIMD

VSRI<c>.<size> <Qd>, <Qm>, #<imm>

VSRI<c>.<size> <Dd>, <Dm>, #<imm>

15	14	13	12	11	10	9	8	7	6	5	4	3	2	1	0	15	14	13	12	11	10	9	8	7	6	5	4	3	2	1	0
1	1	1	1	1	1	1	1	1	D	imm6						Vd			0	1	0	0	L	Q	M	1	Vm				
31	30	29	28	27	26	25	24	23	22	21	20	19	18	17	16	15	14	13	12	11	10	9	8	7	6	5	4	3	2	1	0
1	1	1	1	0	0	1	1	1	D	imm6						Vd			0	1	0	0	L	Q	M	1	Vm				

```

if L:imm6 == '0001xxx' then SEE "Related encodings";
if Q == '1' && (Vd<0> == '1' || Vm<0> == '1') then UNDEFINED;
case L:imm6 of
  when '0001xxx' esize = 8; elements = 8; shift_amount = 16 - UInt(imm6);
  when '001xxxx' esize = 16; elements = 4; shift_amount = 32 - UInt(imm6);
  when '01xxxxx' esize = 32; elements = 2; shift_amount = 64 - UInt(imm6);
  when '1xxxxxx' esize = 64; elements = 1; shift_amount = 64 - UInt(imm6);
d = UInt(D:Vd); m = UInt(M:Vm); regs = if Q == '0' then 1 else 2;

```

Related encodings See *One register and a modified immediate value* on page A7-21

Assembler syntax

VSRI<c><q>.<size> {<Qd>}, <Qm>, #<imm> Encoded as Q = 1
 VSRI<c><q>.<size> {<Dd>}, <Dm>, #<imm> Encoded as Q = 0

where:

<c><q> See *Standard assembler syntax fields* on page A8-7. An ARM VSRI instruction must be unconditional.

<size> The data size for the elements of the vectors. It must be one of:
 8 Encoded as L = '0', imm6<5:3> = '001'. (8 – <imm>) is encoded in imm6<2:0>.
 16 Encoded as L = '0', imm6<5:4> = '01'. (16 – <imm>) is encoded in imm6<3:0>.
 32 Encoded as L = '0', imm6<5> = '1'. (32 – <imm>) is encoded in imm6<4:0>.
 64 Encoded as L = '1'. (64 – <imm>) is encoded in imm6<5:0>.

<Qd>, <Qm> The destination vector, and the operand vector, for a quadword operation.

<Dd>, <Dm> The destination vector, and the operand vector, for a doubleword operation.

<imm> The immediate value, in the range 1 to <size>. See the description of <size> for how <imm> is encoded.

Operation

```
if ConditionPassed() then
    EncodingSpecificOperations(); CheckAdvSIMDEnabled();
    mask = LSR(Ones(esize), shift_amount);
    for r = 0 to regs-1
        for e = 0 to elements-1
            shifted_op = LSR(Elem[D[m+r],e,esize], shift_amount);
            Elem[D[d+r],e,esize] = (Elem[D[d+r],e,esize] AND NOT(mask)) OR shifted_op;
```

Exceptions

Undefined Instruction.

A8.6.391 VST1 (multiple single elements)

Vector Store (multiple single elements) stores elements to memory from one, two, three, or four registers, without interleaving. Every element of each register is stored. For details of the addressing mode see *Advanced SIMD addressing mode* on page A7-30.

Encoding T1 / A1 Advanced SIMD

VST1<c>.<size> <list>, [<Rn>{@<align>}]{!}

VST1<c>.<size> <list>, [<Rn>{@<align>}], <Rm>

15	14	13	12	11	10	9	8	7	6	5	4	3	2	1	0	15	14	13	12	11	10	9	8	7	6	5	4	3	2	1	0
1	1	1	1	1	0	0	0	1	0	D	0	0	Rn				Vd				type				size		align		Rm		
31	30	29	28	27	26	25	24	23	22	21	20	19	18	17	16	15	14	13	12	11	10	9	8	7	6	5	4	3	2	1	0
1	1	1	1	1	0	1	0	0	0	D	0	0	Rn				Vd				type				size		align		Rm		

```

case type of
  when '0111'
    regs = 1; if align<1> == '1' then UNDEFINED;
  when '1010'
    regs = 2; if align == '11' then UNDEFINED;
  when '0110'
    regs = 3; if align<1> == '1' then UNDEFINED;
  when '0010'
    regs = 4;
  otherwise
    SEE "Related encodings";
alignment = if align == '00' then 1 else 4 << UInt(align);
ebytes = 1 << UInt(size); esize = 8 * ebytes; elements = 8 DIV ebytes;
d = UInt(D:Vd); n = UInt(Rn); m = UInt(Rm);
wback = (m != 15); register_index = (m != 15 && m != 13);
if d+regs > 32 then UNPREDICTABLE;

```

Related encodings See *Advanced SIMD element or structure load/store instructions* on page A7-27

Assembler syntax

VST1<c><q>.<size> <list>, [<Rn>{@<align>}] Rm = '1111'
VST1<c><q>.<size> <list>, [<Rn>{@<align>}]! Rm = '1101'
VST1<c><q>.<size> <list>, [<Rn>{@<align>}], <Rm> Rm = other values

where:

<c><q> See *Standard assembler syntax fields* on page A8-7. An ARM VST1 instruction must be unconditional.

<size> The data size. It must be one of:
8 encoded as size = 0b00
16 encoded as size = 0b01

32	encoded as size = 0b10
64	encoded as size = 0b11.
<list>	The list of registers to store. It must be one of: {<Dd>} encoded as D:Vd = <Dd>, type = 0b0111 {<Dd>, <Dd+1>} encoded as D:Vd = <Dd>, type = 0b1010 {<Dd>, <Dd+1>, <Dd+2>} encoded as D:Vd = <Dd>, type = 0b0110 {<Dd>, <Dd+1>, <Dd+2>, <Dd+3>} encoded as D:Vd = <Dd>, type = 0b0010.
<Rn>	Contains the base address for the access.
<align>	The alignment. It can be one of: 64 8-byte alignment, encoded as align = 0b01. 128 16-byte alignment, available only if <list> contains two or four registers, encoded as align = 0b10. 256 32-byte alignment, available only if <list> contains four registers, encoded as align = 0b11. omitted Standard alignment, see <i>Unaligned data access</i> on page A3-5. Encoded as align = 0b00.
!	If present, specifies writeback.
<Rm>	Contains an address offset applied after the access.

For more information about <Rn>, !, and <Rm>, see *Advanced SIMD addressing mode* on page A7-30.

Operation

```

if ConditionPassed() then
    EncodingSpecificOperations(); CheckAdvSIMDEnabled(); NullCheckIfThumbEE(n);
    address = R[n]; if (address MOD alignment) != 0 then GenerateAlignmentException();
    if wback then R[n] = R[n] + (if register_index then R[m] else 8*regs);
    for r = 0 to regs-1
        for e = 0 to elements-1
            MemU[address,ebytes] = Elem[D[d+r],e,esize];
            address = address + ebytes;

```

Exceptions

Undefined Instruction, Data Abort.

A8.6.392 VST1 (single element from one lane)

This instruction stores one element to memory from one element of a register. For details of the addressing mode see *Advanced SIMD addressing mode* on page A7-30.

Encoding T1 / A1 Advanced SIMD

VST1<c>.<size> <list>, [<Rn>{@<align>}]{!}

VST1<c>.<size> <list>, [<Rn>{@<align>}], <Rm>

15	14	13	12	11	10	9	8	7	6	5	4	3	2	1	0	15	14	13	12	11	10	9	8	7	6	5	4	3	2	1	0
1	1	1	1	1	0	0	1	1	D	0	0	Rn				Vd		size		0		0		index_align		Rm					
31	30	29	28	27	26	25	24	23	22	21	20	19	18	17	16	15	14	13	12	11	10	9	8	7	6	5	4	3	2	1	0
1	1	1	1	0	1	0	0	1	D	0	0	Rn				Vd		size		0		0		index_align		Rm					

```

if size == '11' then UNDEFINED;
case size of
  when '00'
    if index_align<0> != '0' then UNDEFINED;
    ebytes = 1; esize = 8; index = UInt(index_align<3:1>); alignment = 1;
  when '01'
    if index_align<1> != '0' then UNDEFINED;
    ebytes = 2; esize = 16; index = UInt(index_align<3:2>);
    alignment = if index_align<0> == '0' then 1 else 2;
  when '10'
    if index_align<2> != '0' then UNDEFINED;
    if index_align<1:0> != '00' && index_align<1:0> != '11' then UNDEFINED;
    ebytes = 4; esize = 32; index = UInt(index_align<3>);
    alignment = if index_align<1:0> == '00' then 1 else 4;
d = UInt(D:Vd); n = UInt(Rn); m = UInt(Rm);
wback = (m != 15); register_index = (m != 15 && m != 13);

```

Assembler syntax

VST1<c><q>.<size> <list>, [<Rn>{@<align>}]	Rm = '1111'
VST1<c><q>.<size> <list>, [<Rn>{@<align>}]!	Rm = '1101'
VST1<c><q>.<size> <list>, [<Rn>{@<align>}], <Rm>	Rm = other values

where:

<c><q> See *Standard assembler syntax fields* on page A8-7. An ARM VST1 instruction must be unconditional.

<size> The data size. It must be one of:

8	encoded as size = 0b00
16	encoded as size = 0b01
32	encoded as size = 0b10.

<list>	The register containing the element to store. It must be {<Dd[x]>}. The register Dd is encoded in D:Vd
<Rn>	Contains the base address for the access.
<align>	The alignment. It can be one of: 16 2-byte alignment, available only if <size> is 16 32 4-byte alignment, available only if <size> is 32 omitted Standard alignment, see <i>Unaligned data access</i> on page A3-5.
!	If present, specifies writeback.
<Rm>	Contains an address offset applied after the access.

For more information about <Rn>, !, and <Rm>, see *Advanced SIMD addressing mode* on page A7-30.

Table A8-9 shows the encoding of index and alignment for different <size> values.

Table A8-9 Encoding of index and alignment

	<size> == 8	<size> == 16	<size> == 32
Index	index_align[3:1] = x	index_align[3:2] = x	index_align[3] = x
<align> omitted	index_align[0] = 0	index_align[1:0] = '00'	index_align[2:0] = '000'
<align> == 16	-	index_align[1:0] = '01'	-
<align> == 32	-	-	index_align[2:0] = '011'

Operation

```

if ConditionPassed() then
    EncodingSpecificOperations(); CheckAdvSIMDEnabled(); NullCheckIfThumbEE(n);
    address = R[n]; if (address MOD alignment) != 0 then GenerateAlignmentException();
    if wback then R[n] = R[n] + (if register_index then R[m] else ebytes);
    MemU[address,ebytes] = Elem[D[d],index,esize];

```

Exceptions

Undefined Instruction, Data Abort.

A8.6.393 VST2 (multiple 2-element structures)

This instruction stores multiple 2-element structures from two or four registers to memory, with interleaving. For more information, see *Element and structure load/store instructions* on page A4-27. Every element of each register is saved. For details of the addressing mode see *Advanced SIMD addressing mode* on page A7-30.

Encoding T1 / A1 Advanced SIMD

VST2<c>.<size> <list>, [<Rn>{@<align>}]{!}

VST2<c>.<size> <list>, [<Rn>{@<align>}], <Rm>

15	14	13	12	11	10	9	8	7	6	5	4	3	2	1	0	15	14	13	12	11	10	9	8	7	6	5	4	3	2	1	0	
1	1	1	1	1	0	0	0	1	0	D	0	0	Rn				Vd				type				size		align		Rm			
31	30	29	28	27	26	25	24	23	22	21	20	19	18	17	16	15	14	13	12	11	10	9	8	7	6	5	4	3	2	1	0	
1	1	1	1	1	0	1	0	0	0	D	0	0	Rn				Vd				type				size		align		Rm			

```

if size == '11' then UNDEFINED;
case type of
  when '1000'
    regs = 1; inc = 1; if align == '11' then UNDEFINED;
  when '1001'
    regs = 1; inc = 2; if align == '11' then UNDEFINED;
  when '0011'
    regs = 2; inc = 2;
  otherwise
    SEE "Related encodings";
alignment = if align == '00' then 1 else 4 << UInt(align);
ebytes = 1 << UInt(size); esize = 8 * ebytes; elements = 8 DIV ebytes;
d = UInt(D:Vd); d2 = d + inc; n = UInt(Rn); m = UInt(Rm);
wback = (m != 15); register_index = (m != 15 && m != 13);
if d2+regs > 32 then UNPREDICTABLE;
    
```

Related encodings See *Advanced SIMD element or structure load/store instructions* on page A7-27

Assembler syntax

VST2<c><q>.<size> <list>, [<Rn>{@<align>}] Rm = '1111'
 VST2<c><q>.<size> <list>, [<Rn>{@<align>}]! Rm = '1101'
 VST2<c><q>.<size> <list>, [<Rn>{@<align>}], <Rm> Rm = other values

where:

- <c><q> See *Standard assembler syntax fields* on page A8-7. An ARM VST2 instruction must be unconditional.
- <size> The data size. It must be one of:
 - 8 encoded as size = 0b00
 - 16 encoded as size = 0b01

32	encoded as size = 0b10.
<list>	The list of registers to store. It must be one of: {<Dd>, <Dd+1>} encoded as D:Vd = <Dd>, type = 0b1000 {<Dd>, <Dd+2>} encoded as D:Vd = <Dd>, type = 0b1001 {<Dd>, <Dd+1>, <Dd+2>, <Dd+3>} encoded as D:Vd = <Dd>, type = 0b0011.
<Rn>	Contains the base address for the access.
<align>	The alignment. It can be one of: 64 8-byte alignment, encoded as align = 0b01. 128 16-byte alignment, encoded as align = 0b10. 256 32-byte alignment, available only if <list> contains four registers, encoded as align = 0b11 omitted Standard alignment, see <i>Unaligned data access</i> on page A3-5. Encoded as align = 0b00.
!	If present, specifies writeback.
<Rm>	Contains an address offset applied after the access.

For more information about <Rn>, !, and <Rm>, see *Advanced SIMD addressing mode* on page A7-30.

Operation

```

if ConditionPassed() then
    EncodingSpecificOperations(); CheckAdvSIMDEnabled(); NullCheckIfThumbEE(n);
    address = R[n]; if (address MOD alignment) != 0 then GenerateAlignmentException();
    if wback then R[n] = R[n] + (if register_index then R[m] else 16*regs);
    for r = 0 to regs-1
        for e = 0 to elements-1
            MemU[address,ebytes] = Elem[D[d+r],e,esize];
            MemU[address+ebytes,ebytes] = Elem[D[d2+r],e,esize];
            address = address + 2*ebytes;

```

Exceptions

Undefined Instruction, Data Abort.

A8.6.394 VST2 (single 2-element structure from one lane)

This instruction stores one 2-element structure to memory from corresponding elements of two registers. For details of the addressing mode see *Advanced SIMD addressing mode* on page A7-30.

Encoding T1 / A1 Advanced SIMD

VST2<c>.<size> <list>, [<Rn>{@<align>}]{!}

VST2<c>.<size> <list>, [<Rn>{@<align>}], <Rm>

15	14	13	12	11	10	9	8	7	6	5	4	3	2	1	0	15	14	13	12	11	10	9	8	7	6	5	4	3	2	1	0
1	1	1	1	1	0	0	1	1	D	0	0	Rn				Vd		size	0	1	index_align			Rm							
31	30	29	28	27	26	25	24	23	22	21	20	19	18	17	16	15	14	13	12	11	10	9	8	7	6	5	4	3	2	1	0
1	1	1	1	0	1	0	0	1	D	0	0	Rn				Vd		size	0	1	index_align			Rm							

```

if size == '11' then UNDEFINED;
case size of
  when '00'
    ebytes = 1; esize = 8; index = UInt(index_align<3:1>); inc = 1;
    alignment = if index_align<0> == '0' then 1 else 2;
  when '01'
    ebytes = 2; esize = 16; index = UInt(index_align<3:2>);
    inc = if index_align<1> == '0' then 1 else 2;
    alignment = if index_align<0> == '0' then 1 else 4;
  when '10'
    if index_align<1> != '0' then UNDEFINED;
    ebytes = 4; esize = 32; index = UInt(index_align<3>);
    inc = if index_align<2> == '0' then 1 else 2;
    alignment = if index_align<0> == '0' then 1 else 8;
d = UInt(D:Vd); d2 = d + inc; n = UInt(Rn); m = UInt(Rm);
wback = (m != 15); register_index = (m != 15 && m != 13);
if d2 > 31 then UNPREDICTABLE;

```

Assembler syntax

- VST2<c><q>.<size> <list>, [<Rn>{@<align>}] Rm = '1111'
- VST2<c><q>.<size> <list>, [<Rn>{@<align>}]! Rm = '1101'
- VST2<c><q>.<size> <list>, [<Rn>{@<align>}], <Rm> Rm = other values

where:

- <c><q> See *Standard assembler syntax fields* on page A8-7. An ARM VST2 instruction must be unconditional.
- <size> The data size. It must be one of:
 - 8 encoded as size = 0b00
 - 16 encoded as size = 0b01
 - 32 encoded as size = 0b10.

<list>	The registers containing the structure. Encoded with D:Vd = <Dd>. It must be one of: {<Dd[x]>, <Dd+1[x]>} Single-spaced registers, see Table A8-10. {<Dd[x]>, <Dd+2[x]>} Double-spaced registers, see Table A8-10. This is not available if <size> == 8.
<Rn>	Contains the base address for the access.
<align>	The alignment. It can be one of: 16 2-byte alignment, available only if <size> is 8 32 4-byte alignment, available only if <size> is 16 64 8-byte alignment, available only if <size> is 32 omitted Standard alignment, see <i>Unaligned data access</i> on page A3-5.
!	If present, specifies writeback.
<Rm>	Contains an address offset applied after the access.

For more information about <Rn>, !, and <Rm>, see *Advanced SIMD addressing mode* on page A7-30.

Table A8-10 Encoding of index, alignment, and register spacing

	<size> == 8	<size> == 16	<size> == 32
Index	index_align[3:1] = x	index_align[3:2] = x	index_align[3] = x
Single-spacing	-	index_align[1] = 0	index_align[2] = 0
Double-spacing	-	index_align[1] = 1	index_align[2] = 1
<align> omitted	index_align[0] = 0	index_align[0] = 0	index_align[1:0] = '00'
<align> == 16	index_align[0] = 1	-	-
<align> == 32	-	index_align[0] = 1	-
<align> == 64	-	-	index_align[1:0] = '01'

Operation

```

if ConditionPassed() then
    EncodingSpecificOperations(); CheckAdvSIMDEnabled(); NullCheckIfThumbEE(n);
    address = R[n]; if (address MOD alignment) != 0 then GenerateAlignmentException();
    if wback then R[n] = R[n] + (if register_index then R[m] else 2*ebytes);
    MemU[address,ebytes] = Elem[D[d],index,esize];
    MemU[address+ebytes,ebytes] = Elem[D[d2],index,esize];

```

Exceptions

Undefined Instruction, Data Abort.

A8.6.395 VST3 (multiple 3-element structures)

This instruction stores multiple 3-element structures to memory from three registers, with interleaving. For more information, see *Element and structure load/store instructions* on page A4-27. Every element of each register is saved. For details of the addressing mode see *Advanced SIMD addressing mode* on page A7-30.

Encoding T1 / A1 Advanced SIMD

VST3<c>.<size> <list>, [<Rn>{@<align>}]{!}

VST3<c>.<size> <list>, [<Rn>{@<align>}], <Rm>

15	14	13	12	11	10	9	8	7	6	5	4	3	2	1	0	15	14	13	12	11	10	9	8	7	6	5	4	3	2	1	0
1	1	1	1	1	0	0	0	1	0	D	0	0	Rn				Vd				type				size		align		Rm		
31	30	29	28	27	26	25	24	23	22	21	20	19	18	17	16	15	14	13	12	11	10	9	8	7	6	5	4	3	2	1	0
1	1	1	1	1	0	1	0	0	0	D	0	0	Rn				Vd				type				size		align		Rm		

```

if size == '11' || align<L> == '1' then UNDEFINED;
case type of
  when '0100'
    inc = 1;
  when '0101'
    inc = 2;
  otherwise
    SEE "Related encodings";
alignment = if align<0> == '0' then 1 else 8;
ebytes = 1 << UInt(size); esize = 8 * ebytes; elements = 8 DIV ebytes;
d = UInt(D:Vd); d2 = d + inc; d3 = d2 + inc; n = UInt(Rn); m = UInt(Rm);
wback = (m != 15); register_index = (m != 15 && m != 13);
if d3 > 31 then UNPREDICTABLE;

```

Related encodings See *Advanced SIMD element or structure load/store instructions* on page A7-27

Assembler syntax

VST3<c><q>.<size> <list>, [<Rn>{@<align>}] Rm = '1111'
VST3<c><q>.<size> <list>, [<Rn>{@<align>}]! Rm = '1101'
VST3<c><q>.<size> <list>, [<Rn>{@<align>}], <Rm> Rm = other values

where:

- <c><q> See *Standard assembler syntax fields* on page A8-7. An ARM VST3 instruction must be unconditional.
- <size> The data size. It must be one of:
 - 8 encoded as size = 0b00
 - 16 encoded as size = 0b01
 - 32 encoded as size = 0b10.

- <list> The list of registers to store. It must be one of:
 {<Dd>, <Dd+1>, <Dd+2>}
 encoded as D:Vd = <Dd>, type = 0b0100
 {<Dd>, <Dd+2>, <Dd+4>}
 encoded as D:Vd = <Dd>, type = 0b0101.
- <Rn> Contains the base address for the access.
- <align> The alignment. It can be:
 64 8-byte alignment, encoded as align = 0b01.
omitted Standard alignment, see *Unaligned data access* on page A3-5. Encoded as
 align = 0b00.
- ! If present, specifies writeback.
- <Rm> Contains an address offset applied after the access.

For more information about <Rn>, !, and <Rm>, see *Advanced SIMD addressing mode* on page A7-30.

Operation

```

if ConditionPassed() then
    EncodingSpecificOperations(); CheckAdvSIMDEnabled(); NullCheckIfThumbEE(n);
    address = R[n]; if (address MOD alignment) != 0 then GenerateAlignmentException();
    if wback then R[n] = R[n] + (if register_index then R[m] else 24);
    for e = 0 to elements-1
        MemU[address,ebytes] = Elem[D[d],e,esize];
        MemU[address+ebytes,ebytes] = Elem[D[d2],e,esize];
        MemU[address+2*ebytes,ebytes] = Elem[D[d3],e,esize];
        address = address + 3*ebytes;

```

Exceptions

Undefined Instruction, Data Abort.

A8.6.396 VST3 (single 3-element structure from one lane)

This instruction stores one 3-element structure to memory from corresponding elements of three registers. For details of the addressing mode see *Advanced SIMD addressing mode* on page A7-30.

Encoding T1 / A1 Advanced SIMD

VST3<c>.<size> <list>, [<Rn>]{}!

VST3<c>.<size> <list>, [<Rn>], <Rm>

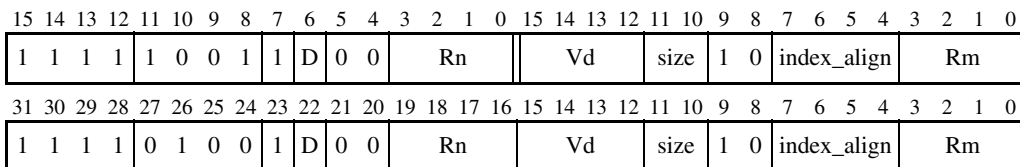

```

if size == '11' then UNDEFINED;
case size of
  when '00'
    if index_align<0> != '0' then UNDEFINED;
    ebytes = 1; esize = 8; index = UInt(index_align<3:1>); inc = 1;
  when '01'
    if index_align<0> != '0' then UNDEFINED;
    ebytes = 2; esize = 16; index = UInt(index_align<3:2>);
    inc = if index_align<1> == '0' then 1 else 2;
  when '10'
    if index_align<1:0> != '00' then UNDEFINED;
    ebytes = 4; esize = 32; index = UInt(index_align<3>);
    inc = if index_align<2> == '0' then 1 else 2;
d = UInt(D:Vd); d2 = d + inc; d3 = d2 + inc; n = UInt(Rn); m = UInt(Rm);
wback = (m != 15); register_index = (m != 15 && m != 13);
if d3 > 31 then UNPREDICTABLE;
    
```

Assembler syntax

VST3<c><q>.<size> <list>, [<Rn>]	Rm = '1111'
VST3<c><q>.<size> <list>, [<Rn>!]	Rm = '1101'
VST3<c><q>.<size> <list>, [<Rn>], <Rm>	Rm = other values

where:

<c><q> See *Standard assembler syntax fields* on page A8-7. An ARM VST3 instruction must be unconditional.

<size> The data size. It must be one of:

8	encoded as size = 0b00
16	encoded as size = 0b01
32	encoded as size = 0b10.

- <list> The registers containing the structure. Encoded with $D:Vd = \langle Dd \rangle$. It must be one of:
 { $\langle Dd[x] \rangle$, $\langle Dd+1[x] \rangle$, $\langle Dd+2[x] \rangle$ }
 Single-spaced registers, see Table A8-11.
 { $\langle Dd[x] \rangle$, $\langle Dd+2[x] \rangle$, $\langle Dd+4[x] \rangle$ }
 Double-spaced registers, see Table A8-11. This is not available if $\langle \text{size} \rangle == 8$.
- <Rn> Contains the base address for the access.
- ! If present, specifies writeback.
- <Rm> Contains an address offset applied after the access.

For more information about <Rn>, !, and <Rm>, see *Advanced SIMD addressing mode* on page A7-30.

Table A8-11 Encoding of index and register spacing

	$\langle \text{size} \rangle == 8$	$\langle \text{size} \rangle == 16$	$\langle \text{size} \rangle == 32$
Index	$\text{index_align}[3:1] = x$	$\text{index_align}[3:2] = x$	$\text{index_align}[3] = x$
Single-spacing	$\text{index_align}[0] = 0$	$\text{index_align}[1:0] = '00'$	$\text{index_align}[2:0] = '000'$
Double-spacing	-	$\text{index_align}[1:0] = '10'$	$\text{index_align}[2:0] = '100'$

Alignment

Standard alignment rules apply, see *Unaligned data access* on page A3-5.

Operation

```

if ConditionPassed() then
    EncodingSpecificOperations(); CheckAdvSIMDEnabled(); NullCheckIfThumbEE(n);
    address = R[n];
    if wback then R[n] = R[n] + (if register_index then R[m] else 3*ebytes);
    MemU[address,ebytes] = Elem[D[d],index,esize];
    MemU[address+ebytes,ebytes] = Elem[D[d2],index,esize];
    MemU[address+2*ebytes,ebytes] = Elem[D[d3],index,esize];
  
```

Exceptions

Undefined Instruction, Data Abort.

A8.6.397 VST4 (multiple 4-element structures)

This instruction stores multiple 4-element structures to memory from four registers, with interleaving. For more information, see *Element and structure load/store instructions* on page A4-27. Every element of each register is saved. For details of the addressing mode see *Advanced SIMD addressing mode* on page A7-30.

Encoding T1 / A1 Advanced SIMD

VST4<c>.<size> <list>, [<Rn>{@<align>}]{!}

VST4<c>.<size> <list>, [<Rn>{@<align>}], <Rm>

15	14	13	12	11	10	9	8	7	6	5	4	3	2	1	0	15	14	13	12	11	10	9	8	7	6	5	4	3	2	1	0
1	1	1	1	1	0	0	0	1	0	D	0	0	Rn				Vd				type		size		align		Rm				
31	30	29	28	27	26	25	24	23	22	21	20	19	18	17	16	15	14	13	12	11	10	9	8	7	6	5	4	3	2	1	0
1	1	1	1	1	0	1	0	0	0	D	0	0	Rn				Vd				type		size		align		Rm				

```

if size == '11' then UNDEFINED;
case type of
  when '0000'
    inc = 1;
  when '0001'
    inc = 2;
  otherwise
    SEE "Related encodings";
alignment = if align == '00' then 1 else 4 << UInt(align);
ebytes = 1 << UInt(size); esize = 8 * ebytes; elements = 8 DIV ebytes;
d = UInt(D:Vd); d2 = d + inc; d3 = d2 + inc; d4 = d3 + inc; n = UInt(Rn); m = UInt(Rm);
wback = (m != 15); register_index = (m != 15 && m != 13);
if d4 > 31 then UNPREDICTABLE;

```

Related encodings See *Advanced SIMD element or structure load/store instructions* on page A7-27

Assembler syntax

VST4<c><q>.<size> <list>, [<Rn>{@<align>}] Rm = '1111'
VST4<c><q>.<size> <list>, [<Rn>{@<align>}]! Rm = '1101'
VST4<c><q>.<size> <list>, [<Rn>{@<align>}], <Rm> Rm = other values

where:

<c><q> See *Standard assembler syntax fields* on page A8-7. An ARM VST4 instruction must be unconditional.

<size> The data size. It must be one of:
8 encoded as size = 0b00
16 encoded as size = 0b01
32 encoded as size = 0b10.

<list>	The list of registers to store. It must be one of: {<Dd>, <Dd+1>, <Dd+2>, <Dd+3>} encoded as D:Vd = <Dd>, type = 0b0000 {<Dd>, <Dd+2>, <Dd+4>, <Dd+6>} encoded as D:Vd = <Dd>, type = 0b0001.
<Rn>	Contains the base address for the access.
<align>	The alignment. It can be one of: 64 8-byte alignment, encoded as align = 0b01. 128 16-byte alignment, encoded as align = 0b10. 256 32-byte alignment, encoded as align = 0b11. omitted Standard alignment, see <i>Unaligned data access</i> on page A3-5. Encoded as align = 0b00.
!	If present, specifies writeback.
<Rm>	Contains an address offset applied after the access.

For more information about <Rn>, !, and <Rm>, see *Advanced SIMD addressing mode* on page A7-30.

Operation

```

if ConditionPassed() then
    EncodingSpecificOperations(); CheckAdvSIMDEnabled(); NullCheckIfThumbEE(n);
    address = R[n]; if (address MOD alignment) != 0 then GenerateAlignmentException();
    if wback then R[n] = R[n] + (if register_index then R[m] else 32);
    for e = 0 to elements-1
        MemU[address,ebytes] = Elem[D[d],e,esize];
        MemU[address+ebytes,ebytes] = Elem[D[d2],e,esize];
        MemU[address+2*ebytes,ebytes] = Elem[D[d3],e,esize];
        MemU[address+3*ebytes,ebytes] = Elem[D[d4],e,esize];
    address = address + 4*ebytes;

```

Exceptions

Undefined Instruction, Data Abort.

A8.6.398 VST4 (single 4-element structure from one lane)

This instruction stores one 4-element structure to memory from corresponding elements of four registers. For details of the addressing mode see *Advanced SIMD addressing mode* on page A7-30.

Encoding T1 / A1 Advanced SIMD

VST4<c>.<size> <list>, [<Rn>{@<align>}]{!}

VST4<c>.<size> <list>, [<Rn>{@<align>}], <Rm>

15	14	13	12	11	10	9	8	7	6	5	4	3	2	1	0	15	14	13	12	11	10	9	8	7	6	5	4	3	2	1	0
1	1	1	1	1	0	0	1	1	D	0	0	Rn				Vd		size	1	1	index_align		Rm								
31	30	29	28	27	26	25	24	23	22	21	20	19	18	17	16	15	14	13	12	11	10	9	8	7	6	5	4	3	2	1	0
1	1	1	1	0	1	0	0	1	D	0	0	Rn				Vd		size	1	1	index_align		Rm								

```

if size == '11' then UNDEFINED;
case size of
  when '00'
    ebytes = 1; esize = 8; index = UInt(index_align<3:1>); inc = 1;
    alignment = if index_align<0> == '0' then 1 else 4;
  when '01'
    ebytes = 2; esize = 16; index = UInt(index_align<3:2>);
    inc = if index_align<1> == '0' then 1 else 2;
    alignment = if index_align<0> == '0' then 1 else 8;
  when '10'
    if index_align<1:0> == '11' then UNDEFINED;
    ebytes = 4; esize = 32; index = UInt(index_align<3>);
    inc = if index_align<2> == '0' then 1 else 2;
    alignment = if index_align<1:0> == '00' then 1 else 4 << UInt(index_align<1:0>);
d = UInt(D:Vd); d2 = d + inc; d3 = d2 + inc; d4 = d3 + inc; n = UInt(Rn); m = UInt(Rm);
wback = (m != 15); register_index = (m != 15 && m != 13);
if d4 > 31 then UNPREDICTABLE;

```

Assembler syntax

VST4<c><q>.<size> <list>, [<Rn>{@<align>}] Rm = '1111'
VST4<c><q>.<size> <list>, [<Rn>{@<align>}]! Rm = '1101'
VST4<c><q>.<size> <list>, [<Rn>{@<align>}], <Rm> Rm = other values

where:

<c><q> See *Standard assembler syntax fields* on page A8-7. An ARM VST4 instruction must be unconditional.

<size> The data size. It must be one of:

8	encoded as size = 0b00
16	encoded as size = 0b01
32	encoded as size = 0b10.

<list>	The registers containing the structure. Encoded with D:Vd = <Dd>. It must be one of: {<Dd[x]>, <Dd+1[x]>, <Dd+2[x]>, <Dd+3[x]>} Single-spaced registers, see Table A8-12. {<Dd[x]>, <Dd+2[x]>, <Dd+4[x]>, <Dd+6[x]>} Double-spaced registers, see Table A8-12. This is not available if <size> == 8.
<Rn>	The base address for the access.
<align>	The alignment. It can be: 32 4-byte alignment, available only if <size> is 8. 64 8-byte alignment, available only if <size> is 16 or 32. 128 16-byte alignment, available only if <size> is 32. omitted Standard alignment, see <i>Unaligned data access</i> on page A3-5.
!	If present, specifies writeback.
<Rm>	Contains an address offset applied after the access.

For more information about <Rn>, !, and <Rm>, see *Advanced SIMD addressing mode* on page A7-30.

Table A8-12 Encoding of index, alignment, and register spacing

	<size> == 8	<size> == 16	<size> == 32
Index	index_align[3:1] = x	index_align[3:2] = x	index_align[3] = x
Single-spacing	-	index_align[1] = 0	index_align[2] = 0
Double-spacing	-	index_align[1] = 1	index_align[2] = 1
<align> omitted	index_align[0] = 0	index_align[0] = 0	index_align[1:0] = '00'
<align> == 32	index_align[0] = 1	-	-
<align> == 64	-	index_align[0] = 1	index_align[1:0] = '01'
<align> == 128	-	-	index_align[1:0] = '10'

Operation

```

if ConditionPassed() then
    EncodingSpecificOperations(); CheckAdvSIMDEnabled(); NullCheckIfThumbEE(n);
    address = R[n]; if (address MOD alignment) != 0 then GenerateAlignmentException();
    if wback then R[n] = R[n] + (if register_index then R[m] else 4*ebytes);
    MemU[address,ebytes] = Elem[D[d],index,esize];
    MemU[address+ebytes,ebytes] = Elem[D[d2],index,esize];
    MemU[address+2*ebytes,ebytes] = Elem[D[d3],index,esize];
    MemU[address+3*ebytes,ebytes] = Elem[D[d4],index,esize];

```

Exceptions

Undefined Instruction, Data Abort.

A8.6.399 VSTM

Vector Store Multiple stores multiple extension registers to consecutive memory locations using an address from an ARM core register.

Encoding T1 / A1 VFPv2, VFPv3, Advanced SIMD

VSTM{mode}<c> <Rn>{!}, <list> <list> is consecutive 64-bit registers

15	14	13	12	11	10	9	8	7	6	5	4	3	2	1	0	15	14	13	12	11	10	9	8	7	6	5	4	3	2	1	0
1	1	1	0	1	1	0	P	U	D	W	0	Rn				Vd				1	0	1	1	imm8							
31 30 29 28 27 26 25 24 23 22 21 20 19 18 17 16 15 14 13 12 11 10 9 8 7 6 5 4 3 2 1 0																															
cond				1	1	0	P	U	D	W	0	Rn				Vd				1	0	1	1	imm8							

```

if P == '0' && U == '0' && W == '0' then SEE "Related encodings";
if P == '1' && U == '0' && W == '1' && Rn == '1101' then SEE VPUSH;
if P == '1' && W == '0' then SEE VSTR;
if P == U && W == '1' then UNDEFINED;
// Remaining combinations are PUW = 010 (IA without !), 011 (IA with !), 101 (DB with !)
single_regs = FALSE; add = (U == '1'); wback = (W == '1');
d = UInt(D:Vd); n = UInt(Rn); imm32 = ZeroExtend(imm8:'00', 32);
regs = UInt(imm8) DIV 2; // If UInt(imm8) is odd, see "FSTMX".
if n == 15 && (wback || CurrentInstrSet() != InstrSet_ARM) then UNPREDICTABLE;
if regs == 0 || regs > 16 || (d+regs) > 32 then UNPREDICTABLE;

```

Encoding T2 / A2 VFPv2, VFPv3

VSTM{mode}<c> <Rn>{!}, <list> <list> is consecutive 32-bit registers

15	14	13	12	11	10	9	8	7	6	5	4	3	2	1	0	15	14	13	12	11	10	9	8	7	6	5	4	3	2	1	0
1	1	1	0	1	1	0	P	U	D	W	0	Rn				Vd				1	0	1	0	imm8							
31 30 29 28 27 26 25 24 23 22 21 20 19 18 17 16 15 14 13 12 11 10 9 8 7 6 5 4 3 2 1 0																															
cond				1	1	0	P	U	D	W	0	Rn				Vd				1	0	1	0	imm8							

```

if P == '0' && U == '0' && W == '0' then SEE "Related encodings";
if P == '1' && U == '0' && W == '1' && Rn == '1101' then SEE VPUSH;
if P == '1' && W == '0' then SEE VSTR;
if P == U && W == '1' then UNDEFINED;
// Remaining combinations are PUW = 010 (IA without !), 011 (IA with !), 101 (DB with !)
single_regs = TRUE; add = (U == '1'); wback = (W == '1'); d = UInt(Vd:D); n = UInt(Rn);
imm32 = ZeroExtend(imm8:'00', 32); regs = UInt(imm8);
if n == 15 && (wback || CurrentInstrSet() != InstrSet_ARM) then UNPREDICTABLE;
if regs == 0 || (d+regs) > 32 then UNPREDICTABLE;

```

Related encodings See *64-bit transfers between ARM core and extension registers* on page A7-32

FSTMX

Encoding T1/A1 behaves as described by the pseudocode if imm8 is odd.
 However, there is no UAL syntax for such encodings and their use is deprecated.
 For more information, see *FLDMX, FSTMX* on page A8-101.

Assembler syntax

VSTM{<mode>}<c><q>{.<size>} <Rn>{!}, <list>

where:

<mode>	The addressing mode: <ul style="list-style-type: none"> IA Increment After. The consecutive addresses start at the address specified in <Rn>. This is the default and can be omitted. Encoded as P = 0, U = 1. DB Decrement Before. The consecutive addresses end just before the address specified in <Rn>. Encoded as P = 1, U = 0.
<c><q>	See <i>Standard assembler syntax fields</i> on page A8-7.
<size>	An optional data size specifier. If present, it must be equal to the size in bits, 32 or 64, of the registers in <list>.
<Rn>	The base register. The SP can be used. In the ARM instruction set, if ! is not specified the PC can be used. However, use of the PC is deprecated.
!	Causes the instruction to write a modified value back to <Rn>. Required if <mode> == DB. Encoded as W = 1. If ! is omitted, the instruction does not change <Rn> in this way. Encoded as W = 0.
<list>	The extension registers to be stored, as a list of consecutively numbered doubleword (encoding T1 / A1) or singleword (encoding T2 / A2) registers, separated by commas and surrounded by brackets. It is encoded in the instruction by setting D and Vd to specify the first register in the list, and imm8 to twice the number of registers in the list (encoding T1 / A1) or the number of registers (encoding T2 / A2). <list> must contain at least one register. If it contains doubleword registers it must not contain more than 16 registers.

Operation

```

if ConditionPassed() then
    EncodingSpecificOperations(); CheckVFPEnabled(TRUE); NullCheckIfThumbEE(n);
    address = if add then R[n] else R[n]-imm32;
    if wback then R[n] = if add then R[n]+imm32 else R[n]-imm32;
    for r = 0 to regs-1
        if single_regs then
            MemA[address,4] = S[d+r]; address = address+4;
        else
            // Store as two word-aligned words in the correct order for current endianness.
            MemA[address,4] = if BigEndian() then D[d+r]<63:32> else D[d+r]<31:0>;
            MemA[address+4,4] = if BigEndian() then D[d+r]<31:0> else D[d+r]<63:32>;
            address = address+8;

```

Exceptions

Undefined Instruction, Data Abort.

A8.6.400 VSTR

This instruction stores a single extension register to memory, using an address from an ARM core register, with an optional offset.

Encoding T1 / A1 VFPv2, VFPv3, Advanced SIMD

VSTR<c> <Dd>, [<Rn>{, #+/-<imm>}]

15	14	13	12	11	10	9	8	7	6	5	4	3	2	1	0	15	14	13	12	11	10	9	8	7	6	5	4	3	2	1	0
1	1	1	0	1	1	0	1	U	D	0	0	Rn				Vd				1	0	1	1	imm8							
31	30	29	28	27	26	25	24	23	22	21	20	19	18	17	16	15	14	13	12	11	10	9	8	7	6	5	4	3	2	1	0
cond				1	1	0	1	U	D	0	0	Rn				Vd				1	0	1	1	imm8							

```
single_reg = FALSE; add = (U == '1'); imm32 = ZeroExtend(imm8:'00', 32);
d = UInt(D:Vd); n = UInt(Rn);
if n == 15 && CurrentInstrSet() != InstrSet_ARM then UNPREDICTABLE;
```

Encoding T2 / A2 VFPv2, VFPv3

VSTR<c> <Sd>, [<Rn>{, #+/-<imm>}]

15	14	13	12	11	10	9	8	7	6	5	4	3	2	1	0	15	14	13	12	11	10	9	8	7	6	5	4	3	2	1	0
1	1	1	0	1	1	0	1	U	D	0	0	Rn				Vd				1	0	1	0	imm8							
31	30	29	28	27	26	25	24	23	22	21	20	19	18	17	16	15	14	13	12	11	10	9	8	7	6	5	4	3	2	1	0
cond				1	1	0	1	U	D	0	0	Rn				Vd				1	0	1	0	imm8							

```
single_reg = TRUE; add = (U == '1'); imm32 = ZeroExtend(imm8:'00', 32);
d = UInt(Vd:D); n = UInt(Rn);
if n == 15 && CurrentInstrSet() != InstrSet_ARM then UNPREDICTABLE;
```

Assembler syntax

VSTR<c><q>{.64} <Dd>, [<Rn>{, #+/-<imm>}] Encoding T1 / A1
 VSTR<c><q>{.32} <Sd>, [<Rn>{, #+/-<imm>}] Encoding T2 / A2

where:

<c><q> See *Standard assembler syntax fields* on page A8-7.
 .32, .64 Optional data size specifiers.
 <Dd> The source register for a doubleword store.
 <Sd> The source register for a singleword store.
 <Rn> The base register. The SP can be used. In the ARM instruction set the PC can be used. However, use of the PC is deprecated.
 +/- Is + or omitted if the immediate offset is to be added to the base register value (add == TRUE), or – if it is to be subtracted (add == FALSE). #0 and #-0 generate different instructions.
 <imm> The immediate offset used to form the address. Values are multiples of 4 in the range 0-1020. <imm> can be omitted, meaning an offset of +0.

Operation

```
if ConditionPassed() then
    EncodingSpecificOperations(); CheckVFPEnabled(TRUE); NullCheckIfThumbEE(n);
    address = if add then (R[n] + imm32) else (R[n] - imm32);
    if single_reg then
        MemA[address,4] = S[d];
    else
        // Store as two word-aligned words in the correct order for current endianness.
        MemA[address,4] = if BigEndian() then D[d]<63:32> else D[d]<31:0>;
        MemA[address+4,4] = if BigEndian() then D[d]<31:0> else D[d]<63:32>;
```

Exceptions

Undefined Instruction, Data Abort.

A8.6.401 VSUB (integer)

Vector Subtract subtracts the elements of one vector from the corresponding elements of another vector, and places the results in the destination vector.

Encoding T1 / A1 Advanced SIMD

VSUB<c>.<dt> <Qd>, <Qn>, <Qm>

VSUB<c>.<dt> <Dd>, <Dn>, <Dm>

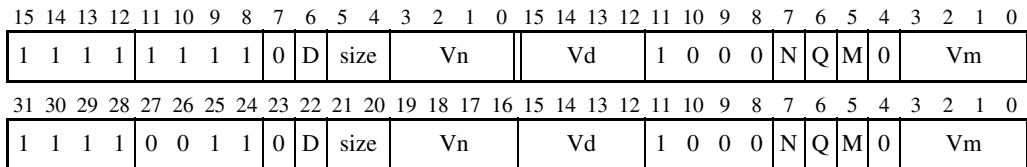

```

if Q == '1' && (Vd<0> == '1' || Vn<0> == '1' || Vm<0> == '1') then UNDEFINED;
esize = 8 << UInt(size); elements = 64 DIV esize;
d = UInt(D:Vd); n = UInt(N:Vn); m = UInt(M:Vm); regs = if Q == '0' then 1 else 2;
    
```

Assembler syntax

VSUB<c><q>.<dt> {<Qd>}, <Qn>, <Qm>

VSUB<c><q>.<dt> {<Dd>}, <Dn>, <Dm>

where:

<c><q> See *Standard assembler syntax fields* on page A8-7. An ARM Advanced SIMD VSUB instruction must be unconditional.

<dt> The data type for the elements of the vectors. It must be one of:

I8 size = 0b00

I16 size = 0b01

I32 size = 0b10

I64 size = 0b11.

<Qd>, <Qn>, <Qm> The destination vector and the operand vectors, for a quadword operation.

<Dd>, <Dn>, <Dm> The destination vector and the operand vectors, for a doubleword operation.

Operation

```

if ConditionPassed() then
    EncodingSpecificOperations(); CheckAdvSIMDEnabled();
    for r = 0 to regs-1
        for e = 0 to elements-1
            Elem[D[d+r],e,esize] = Elem[D[n+r],e,esize] - Elem[D[m+r],e,esize];

```

Exceptions

Undefined Instruction.

A8.6.402 VSUB (floating-point)

Vector Subtract subtracts the elements of one vector from the corresponding elements of another vector, and places the results in the destination vector.

Encoding T1 / A1 Advanced SIMD (UNDEFINED in integer-only variant)

VSUB<c>.F32 <Qd>, <Qn>, <Qm>

VSUB<c>.F32 <Dd>, <Dn>, <Dm>

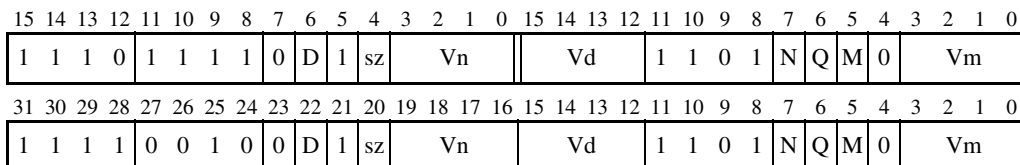

```

if Q == '1' && (Vd<0> == '1' || Vn<0> == '1' || Vm<0> == '1') then UNDEFINED;
if sz == '1' then UNDEFINED;
advsimd = TRUE; esize = 32; elements = 2;
d = UInt(D:Vd); n = UInt(N:Vn); m = UInt(M:Vm); regs = if Q == '0' then 1 else 2;
    
```

Encoding T2 / A2 VFPv2, VFPv3 (sz = 1 UNDEFINED in single-precision only variants)

VSUB<c>.F64 <Dd>, <Dn>, <Dm>

VSUB<c>.F32 <Sd>, <Sn>, <Sm>

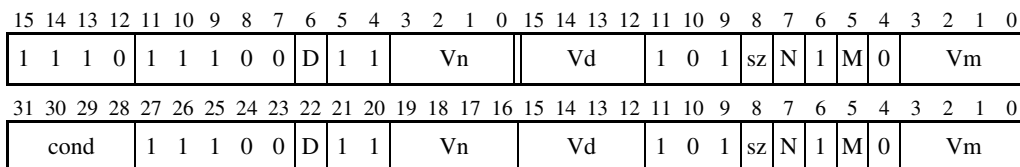

```

if FPSCR.LEN != '000' || FPSCR.STRIDE != '00' then SEE "VFP vectors";
advsimd = FALSE; dp_operation = (sz == '1');
d = if dp_operation then UInt(D:Vd) else UInt(Vd:D);
n = if dp_operation then UInt(N:Vn) else UInt(Vn:N);
m = if dp_operation then UInt(M:Vm) else UInt(Vm:M);
    
```

VFP vectors Encoding T2 / A2 can operate on VFP vectors under control of the FPSCR.LEN and FPSCR.STRIDE bits. For details see Appendix F *VFP Vector Operation Support*.

Assembler syntax

VSUB<c><q>.F32 {<Qd>}, <Qn>, <Qm>	Encoding T1 / A1, Q = 1, sz = 0
VSUB<c><q>.F32 {<Dd>}, <Dn>, <Dm>	Encoding T1 / A1, Q = 0, sz = 0
VSUB<c><q>.F64 {<Dd>}, <Dn>, <Dm>	Encoding T2 / A2, sz = 1
VSUB<c><q>.F32 {<Sd>}, <Sn>, <Sm>	Encoding T2 / A2, sz = 0

where:

<c><q>	See <i>Standard assembler syntax fields</i> on page A8-7. An ARM Advanced SIMD VSUB instruction must be unconditional.
<Qd>, <Qn>, <Qm>	The destination vector and the operand vectors, for a quadword operation.
<Dd>, <Dn>, <Dm>	The destination vector and the operand vectors, for a doubleword operation.
<Sd>, <Sn>, <Sm>	The destination vector and the operand vectors, for a singleword operation.

Operation

```

if ConditionPassed() then
    EncodingSpecificOperations(); CheckAdvSIMDOrVFPEnabled(TRUE, advsimd);
    if advsimd then // Advanced SIMD instruction
        for r = 0 to regs-1
            for e = 0 to elements-1
                Elem[D[d+r],e,esize] = FPSub(Elem[D[n+r],e,esize], Elem[D[m+r],e,esize], FALSE);
    else // VFP instruction
        if dp_operation then
            D[d] = FPSub(D[n], D[m], TRUE);
        else
            S[d] = FPSub(S[n], S[m], TRUE);

```

Exceptions

Undefined Instruction.

Floating-point exceptions: Input Denormal, Invalid Operation, Overflow, Underflow, and Inexact.

A8.6.403 VSUBHN

Vector Subtract and Narrow, returning High Half subtracts the elements of one quadword vector from the corresponding elements of another quadword vector takes the most significant half of each result, and places the final results in a doubleword vector. The results are truncated. (For rounded results, see *VRSUBHN* on page A8-748.

There is no distinction between signed and unsigned integers.

Encoding T1 / A1 Advanced SIMD

VSUBHN<c>.<dt> <Dd>, <Qn>, <Qm>

15	14	13	12	11	10	9	8	7	6	5	4	3	2	1	0	15	14	13	12	11	10	9	8	7	6	5	4	3	2	1	0
1	1	1	0	1	1	1	1	1	D	size	Vn				Vd				0	1	1	0	N	0	M	0	Vm				
31	30	29	28	27	26	25	24	23	22	21	20	19	18	17	16	15	14	13	12	11	10	9	8	7	6	5	4	3	2	1	0
1	1	1	1	0	0	1	0	1	D	size	Vn				Vd				0	1	1	0	N	0	M	0	Vm				

```

if size == '11' then SEE "Related encodings";
if Vn<0> == '1' || Vm<0> == '1' then UNDEFINED;
esize = 8 << UInt(size);  elements = 64 DIV esize;
d = UInt(D:Vd);  n = UInt(N:Vn);  m = UInt(M:Vm);
    
```

Related encodings See *Advanced SIMD data-processing instructions* on page A7-10

Assembler syntax

VSUBHN<c><q>.<dt> <Dd>, <Qn>, <Qm>

where:

<c><q> See *Standard assembler syntax fields* on page A8-7. An ARM VSUBHN instruction must be unconditional.

<dt> The data type for the elements of the operands. It must be one of:
 I16 size = 0b00
 I32 size = 0b01
 I64 size = 0b10.

<Dd>, <Qn>, <Qm> The destination vector, the first operand vector, and the second operand vector.

Operation

```
if ConditionPassed() then
    EncodingSpecificOperations(); CheckAdvSIMDEnabled();
    for e = 0 to elements-1
        result = Elem[Q[n>>1],e,2*esize] - Elem[Q[m>>1],e,2*esize];
        Elem[D[d],e,esize] = result<2*esize-1:esize>;
```

Exceptions

Undefined Instruction.

A8.6.404 VSUBL, VSUBW

Vector Subtract Long subtracts the elements of one doubleword vector from the corresponding elements of another doubleword vector, and places the results in a quadword vector. Before subtracting, it sign-extends or zero-extends the elements of both operands.

Vector Subtract Wide subtracts the elements of a doubleword vector from the corresponding elements of a quadword vector, and places the results in another quadword vector. Before subtracting, it sign-extends or zero-extends the elements of the doubleword operand.

Encoding T1 / A1 Advanced SIMD

VSUBL<c>.<dt> <Qd>, <Dn>, <Dm>

VSUBW<c>.<dt> {<Qd>}, <Qn>, <Dm>

15	14	13	12	11	10	9	8	7	6	5	4	3	2	1	0	15	14	13	12	11	10	9	8	7	6	5	4	3	2	1	0
1	1	1	U	1	1	1	1	1	D	size	Vn				Vd				0	0	1	op	N	0	M	0	Vm				
31	30	29	28	27	26	25	24	23	22	21	20	19	18	17	16	15	14	13	12	11	10	9	8	7	6	5	4	3	2	1	0
1	1	1	1	0	0	1	U	1	D	size	Vn				Vd				0	0	1	op	N	0	M	0	Vm				

```

if size == '11' then SEE "Related encodings";
if Vd<0> == '1' || (op == '1' && Vn<0> == '1') then UNDEFINED;
esize = 8 << UInt(size); elements = 64 DIV esize; is_vsubw == (op == '1');
d = UInt(D:Vd); n = UInt(N:Vn); m = UInt(M:Vm);
    
```

Related encodings See *Advanced SIMD data-processing instructions* on page A7-10

Assembler syntax

VSUBL<c><q>.<dt> <Qd>, <Dn>, <Dm> Encoded as op = 0
 VSUBW<c><q>.<dt> {<Qd>,<Qn>,<Dm>} Encoded as op = 1

where:

<c><q> See *Standard assembler syntax fields* on page A8-7. An ARM VSUBL or VSUBW instruction must be unconditional.

<dt> The data type for the elements of the second operand. It must be one of:

S8	encoded as size = 0b00, U = 0
S16	encoded as size = 0b01, U = 0
S32	encoded as size = 0b10, U = 0
U8	encoded as size = 0b00, U = 1
U16	encoded as size = 0b01, U = 1
U32	encoded as size = 0b10, U = 1.

<Qd> The destination register.

<Qn>, <Dm> The first and second operand registers for a VSUBW instruction.

<Dn>, <Dm> The first and second operand registers for a VSUBL instruction.

Operation

```
if ConditionPassed() then
    EncodingSpecificOperations(); CheckAdvSIMDEnabled();
    for e = 0 to elements-1
        if is_vsubw then
            op1 = Int(Elem[Q[n>>1],e,2*esize], unsigned);
        else
            op1 = Int(Elem[D[n],e,esize], unsigned);
            result = op1 - Int(Elem[D[m],e,esize], unsigned);
            Elem[Q[d>>1],e,2*esize] = result<2*esize-1:0>;
```

Exceptions

Undefined Instruction.

A8.6.405 VSWP

VSWP (Vector Swap) exchanges the contents of two vectors. The vectors can be either doubleword or quadword. There is no distinction between data types.

Encoding T1 / A1 Advanced SIMD

VSWP<C> <Qd>, <Qm>

VSWP<C> <Dd>, <Dm>

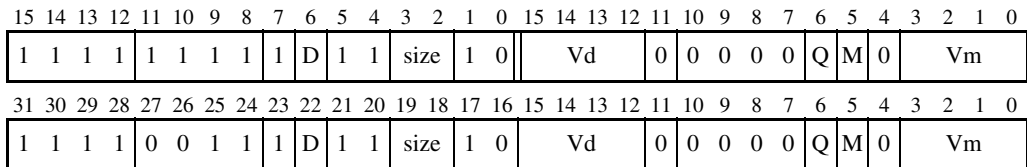

```

if size != '00' then UNDEFINED;
if Q == '1' && (Vd<0> == '1' || Vm<0> == '1') then UNDEFINED;
d = UInt(D:Vd); m = UInt(M:Vm); regs = if Q == '0' then 1 else 2;
    
```

Assembler syntax

VSWP<c><q>{.<dt>} <Qd>, <Qm> Encoded as Q = 1, size = '00'
 VSWP<c><q>{.<dt>} <Dd>, <Dm> Encoded as Q = 0, size = '00'

where:

<c><q> See *Standard assembler syntax fields* on page A8-7. An ARM VSWP instruction must be unconditional.

<dt> An optional data type. It is ignored by assemblers, and does not affect the encoding.

<Qd>, <Qm> The vectors for a quadword operation.

<Dd>, <Dm> The vectors for a doubleword operation.

Operation

```
if ConditionPassed() then
    EncodingSpecificOperations(); CheckAdvSIMDEnabled();
    for r = 0 to regs-1
        if d == m then
            D[d+r] = bits(64) UNKNOWN;
        else
            tmp = D[d+r];
            D[d+r] = D[m+r];
            D[m+r] = tmp;
```

Exceptions

Undefined Instruction.

A8.6.406 VTBL, VTBX

Vector Table Lookup uses byte indexes in a control vector to look up byte values in a table and generate a new vector. Indexes out of range return 0.

Vector Table Extension works in the same way, except that indexes out of range leave the destination element unchanged.

Encoding T1 / A1 Advanced SIMD

V<op><c>.8 <Dd>, <list>, <Dm>

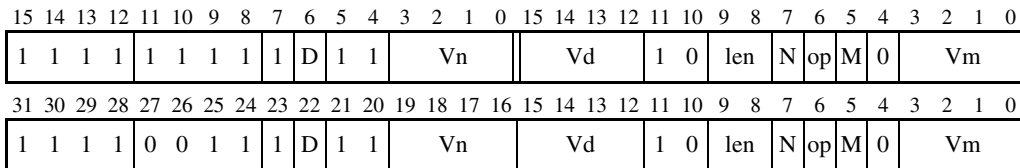

```
is_vtbl = (op == '0'); length = UInt(len)+1;
d = UInt(D:Vd); n = UInt(N:Vn); m = UInt(M:Vm);
if n+length > 32 then UNPREDICTABLE;
```

Assembler syntax

V<op><c><q>.8 <Dd>, <list>, <Dm>

where:

<op>	Specifies the operation. It must be one of: TBL encoded as op = 0 TBX encoded as op = 1
<c><q>	See <i>Standard assembler syntax fields</i> on page A8-7. An ARM VTBL or VTBX instruction must be unconditional.
<Dd>	The destination vector.
<list>	The vectors containing the table. It must be one of: {<Dn>} encoded as len = 0b00 {<Dn>, <Dn+1>} encoded as len = 0b01 {<Dn>, <Dn+1>, <Dn+2>} encoded as len = 0b10 {<Dn>, <Dn+1>, <Dn+2>, <Dn+3>} encoded as len = 0b11
<Dm>	The index vector.

Operation

```

if ConditionPassed() then
    EncodingSpecificOperations(); CheckAdvSIMDEnabled();

    // Create 256-bit = 32-byte table variable, with zeros in entries that will not be used.
    table3 = if length == 4 then D[n+3] else Zeros(64);
    table2 = if length >= 3 then D[n+2] else Zeros(64);
    table1 = if length >= 2 then D[n+1] else Zeros(64);
    table = table3 : table2 : table1 : D[n];

    for i = 0 to 7
        index = UInt(Elem[D[m], i, 8]);
        if index < 8*length then
            Elem[D[d], i, 8] = Elem[table, index, 8];
        else
            if is_vtbl then
                Elem[D[d], i, 8] = Zeros(8);
            // else Elem[D[d], i, 8] unchanged

```

Exceptions

Undefined Instruction.

A8.6.407 VTRN

Vector Transpose treats the elements of its operand vectors as elements of 2×2 matrices, and transposes the matrices.

The elements of the vectors can be 8-bit, 16-bit, or 32-bit. There is no distinction between data types.

Encoding T1 / A1 Advanced SIMD

VTRN<c>.<size> <Qd>, <Qm>

VTRN<c>.<size> <Dd>, <Dm>

15	14	13	12	11	10	9	8	7	6	5	4	3	2	1	0	15	14	13	12	11	10	9	8	7	6	5	4	3	2	1	0
1	1	1	1	1	1	1	1	D	1	1	size	1	0	Vd				0	0	0	0	1	Q	M	0	Vm					
31	30	29	28	27	26	25	24	23	22	21	20	19	18	17	16	15	14	13	12	11	10	9	8	7	6	5	4	3	2	1	0
1	1	1	1	0	0	1	1	1	D	1	1	size	1	0	Vd				0	0	0	0	1	Q	M	0	Vm				

```

if size == '11' then UNDEFINED;
if Q == '1' && (Vd<0> == '1' || Vm<0> == '1') then UNDEFINED;
esize = 8 << UInt(size); elements = 64 DIV esize;
d = UInt(D:Vd); m = UInt(M:Vm); regs = if Q == '0' then 1 else 2;
    
```

Figure A8-7 shows the operation of doubleword VTRN. Quadword VTRN performs the same operation as doubleword VTRN twice, once on the upper halves of the quadword vectors, and once on the lower halves

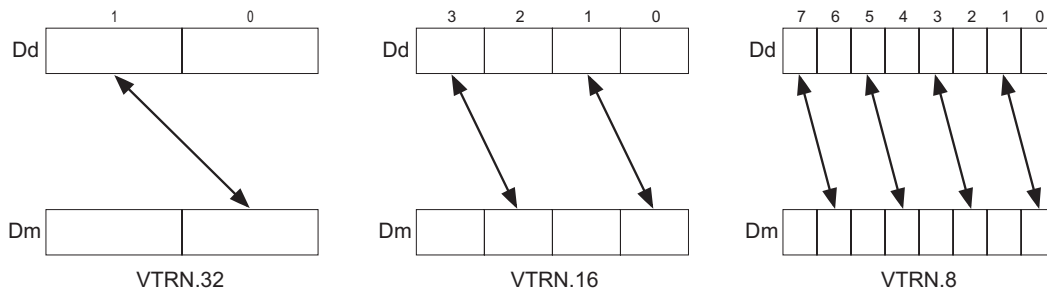

Figure A8-7 Operation of doubleword VTRN

Assembler syntax

VTRN<c><q>.<size> <Qd>, <Qm> Encoded as Q = 1
 VTRN<c><q>.<size> <Dd>, <Dm> Encoded as Q = 0

where:

<c><q> See *Standard assembler syntax fields* on page A8-7. An ARM VTRN instruction must be unconditional.

<size> The data size for the elements of the vectors. It must be one of:
 8 encoded as size = 0b00
 16 encoded as size = 0b01
 32 encoded as size = 0b10.

<Qd>, <Qm> The destination vector, and the operand vector, for a quadword operation.

<Dd>, <Dm> The destination vector, and the operand vector, for a doubleword operation.

Operation

```
if ConditionPassed() then
    EncodingSpecificOperations(); CheckAdvSIMDEnabled();
    h = elements/2;

    for r = 0 to regs-1
        if d == m then
            D[d+r] = bits(64) UNKNOWN;
        else
            for e = 0 to h-1
                tmp = Elem[D[d+r], 2*e+1, esize];
                Elem[D[d+r], 2*e+1, esize] = Elem[D[m+r], 2*e, esize];
                Elem[D[m+r], 2*e, esize] = tmp;
```

Exceptions

Undefined Instruction.

A8.6.408 VTST

Vector Test Bits takes each element in a vector, and bitwise ANDs it with the corresponding element of a second vector. If the result is not zero, the corresponding element in the destination vector is set to all ones. Otherwise, it is set to all zeros.

The operand vector elements can be any one of:

- 8-bit, 16-bit, or 32-bit fields.

The result vector elements are bitfields the same size as the operand vector elements.

Encoding T1 / A1 Advanced SIMD

VTST<c>.<size> <Qd>, <Qn>, <Qm>

VTST<c>.<size> <Dd>, <Dn>, <Dm>

15	14	13	12	11	10	9	8	7	6	5	4	3	2	1	0	15	14	13	12	11	10	9	8	7	6	5	4	3	2	1	0
1	1	1	0	1	1	1	1	0	D	size	Vn				Vd				1	0	0	0	N	Q	M	1	Vm				
31	30	29	28	27	26	25	24	23	22	21	20	19	18	17	16	15	14	13	12	11	10	9	8	7	6	5	4	3	2	1	0
1	1	1	1	0	0	1	0	0	D	size	Vn				Vd				1	0	0	0	N	Q	M	1	Vm				

```

if Q == '1' && (Vd<0> == '1' || Vn<0> == '1' || Vm<0> == '1') then UNDEFINED;
if size == '11' then UNDEFINED;
esize = 8 << UInt(size);  elements = 64 DIV esize;
d = UInt(D:Vd);  n = UInt(N:Vn);  m = UInt(M:Vm);  regs = if Q == '0' then 1 else 2;
    
```

Assembler syntax

VTST<c><q>.<size> {<Qd>}, <Qn>, <Qm> Encoded as Q = 1
 VTST<c><q>.<size> {<Dd>}, <Dn>, <Dm> Encoded as Q = 0

where:

<c><q> See *Standard assembler syntax fields* on page A8-7. An ARM VTST instruction must be unconditional.

<size> The data size for the elements of the operands. It must be one of:
 8 encoded as size = 0b00
 16 encoded as size = 0b01
 32 encoded as size = 0b10.

<Qd>, <Qn>, <Qm> The destination vector and the operand vectors, for a quadword operation.

<Dd>, <Dn>, <Dm> The destination vector and the operand vectors, for a doubleword operation.

Operation

```

if ConditionPassed() then
  EncodingSpecificOperations(); CheckAdvSIMDEnabled();
  for r = 0 to regs-1
    for e = 0 to elements-1
      if !IsZero(Elem[D[n+r],e,esize] AND Elem[D[m+r],e,esize]) then
        Elem[D[d+r],e,esize] = Ones(esize);
      else
        Elem[D[d+r],e,esize] = Zeros(esize);
  
```

Exceptions

Undefined Instruction.

A8.6.409 VUZP

Vector Unzip de-interleaves the elements of two vectors. See Table A8-13 and Table A8-14 for examples of the operation.

The elements of the vectors can be 8-bit, 16-bit, or 32-bit. There is no distinction between data types.

Encoding T1 / A1 Advanced SIMD

VUZP<C>.<size> <Qd>, <Qm>

VUZP<C>.<size> <Dd>, <Dm>

15	14	13	12	11	10	9	8	7	6	5	4	3	2	1	0	15	14	13	12	11	10	9	8	7	6	5	4	3	2	1	0
1	1	1	1	1	1	1	1	D	1	1	size	1	0	Vd	0	0	0	1	0	Q	M	0	Vm								
31	30	29	28	27	26	25	24	23	22	21	20	19	18	17	16	15	14	13	12	11	10	9	8	7	6	5	4	3	2	1	0
1	1	1	1	0	0	1	1	1	D	1	1	size	1	0	Vd	0	0	0	1	0	Q	M	0	Vm							

```

if size == '11' || (Q == '0' && size == '10') then UNDEFINED;
if Q == '1' && (Vd<0> == '1' || Vm<0> == '1') then UNDEFINED;
quadword_operation = (Q == '1'); esize = 8 << UInt(size);
d = UInt(D:Vd); m = UInt(M:Vm);
    
```

Table A8-13 Operation of doubleword VUZP.8

	Register state before operation	Register state after operation
Dd	A ₇ A ₆ A ₅ A ₄ A ₃ A ₂ A ₁ A ₀	B ₆ B ₄ B ₂ B ₀ A ₆ A ₄ A ₂ A ₀
Dm	B ₇ B ₆ B ₅ B ₄ B ₃ B ₂ B ₁ B ₀	B ₇ B ₅ B ₃ B ₁ A ₇ A ₅ A ₃ A ₁

Table A8-14 Operation of quadword VUZP.32

	Register state before operation	Register state after operation
Qd	A ₃ A ₂ A ₁ A ₀	B ₂ B ₀ A ₂ A ₀
Qm	B ₃ B ₂ B ₁ B ₀	B ₃ B ₁ A ₃ A ₁

Assembler syntax

VUZP<c><q>.<size> <Qd>, <Qm> Encoded as Q = 1
 VUZP<c><q>.<size> <Dd>, <Dm> Encoded as Q = 0

where:

<c><q> See *Standard assembler syntax fields* on page A8-7. An ARM VUZP instruction must be unconditional.

<size> The data size for the elements of the vectors. It must be one of:
 8 encoded as size = 0b00.
 16 encoded as size = 0b01.
 32 encoded as size = 0b10 for a quadword operation.
 Doubleword operation with <size> = 32 is a pseudo-instruction.

<Qd>, <Qm> The vectors for a quadword operation.

<Dd>, <Dm> The vectors for a doubleword operation.

Operation

```

if ConditionPassed() then
    EncodingSpecificOperations(); CheckAdvSIMDEnabled();
    if quadword_operation then
        if d == m then
            Q[d>>1] = bits(128) UNKNOWN; Q[m>>1] = bits(128) UNKNOWN;
        else
            zipped_q = Q[m>>1]:Q[d>>1];
            for e = 0 to (128 DIV esize) - 1
                Elem[Q[d>>1],e,esize] = Elem[zipped_q,2*e,esize];
                Elem[Q[m>>1],e,esize] = Elem[zipped_q,2*e+1,esize];
    else
        if d == m then
            D[d] = bits(64) UNKNOWN; D[m] = bits(64) UNKNOWN;
        else
            zipped_d = D[m]:D[d];
            for e = 0 to (64 DIV esize) - 1
                Elem[D[d],e,esize] = Elem[zipped_d,2*e,esize];
                Elem[D[m],e,esize] = Elem[zipped_d,2*e+1,esize];
  
```

Exceptions

Undefined Instruction.

Pseudo-instruction

VUZP.32 <Dd>, <Dm> is a synonym for VTRN.32 <Dd>, <Dm>.

For details see *VTRN* on page A8-800.

A8.6.410 VZIP

Vector Zip interleaves the elements of two vectors. See Table A8-15 and Table A8-16 for examples of the operation.

The elements of the vectors can be 8-bit, 16-bit, or 32-bit. There is no distinction between data types.

Encoding T1 / A1 Advanced SIMD

VZIP<C>.<size> <Qd>, <Qm>

VZIP<C>.<size> <Dd>, <Dm>

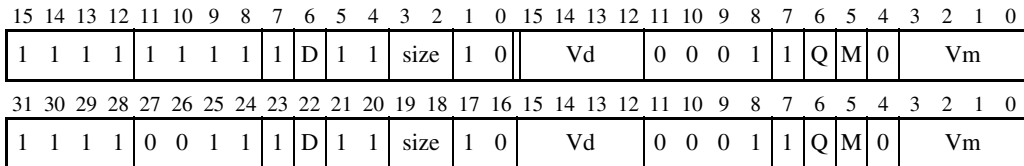

```

if size == '11' || (Q == '0' && size == '10') then UNDEFINED;
if Q == '1' && (Vd<0> == '1' || Vm<0> == '1') then UNDEFINED;
quadword_operation = (Q == '1');  esize = 8 << UInt(size);
d = UInt(D:Vd);  m = UInt(M:Vm);
    
```

Table A8-15 Operation of doubleword VZIP.8

	Register state before operation	Register state after operation
Dd	A ₇ A ₆ A ₅ A ₄ A ₃ A ₂ A ₁ A ₀	B ₃ A ₃ B ₂ A ₂ B ₁ A ₁ B ₀ A ₀
Dm	B ₇ B ₆ B ₅ B ₄ B ₃ B ₂ B ₁ B ₀	B ₇ A ₇ B ₆ A ₆ B ₅ A ₅ B ₄ A ₄

Table A8-16 Operation of quadword VZIP.32

	Register state before operation	Register state after operation
Qd	A ₃ A ₂ A ₁ A ₀	B ₁ A ₁ B ₀ A ₀
Qm	B ₃ B ₂ B ₁ B ₀	B ₃ A ₃ B ₂ A ₂

Assembler syntax

VZIP<c><q>.<size> <Qd>, <Qm> Encoded as Q = 1
 VZIP<c><q>.<size> <Dd>, <Dm> Encoded as Q = 0

where:

<c><q> See *Standard assembler syntax fields* on page A8-7. An ARM VZIP instruction must be unconditional.

<size> The data size for the elements of the vectors. It must be one of:
 8 encoded as size = 0b00.
 16 encoded as size = 0b01.
 32 encoded as size = 0b10 for a quadword operation.
 Doubleword operation with <size> = 32 is a pseudo-instruction.

<Qd>, <Qm> The vectors for a quadword operation.

<Dd>, <Dm> The vectors for a doubleword operation.

Operation

```

if ConditionPassed() then
    EncodingSpecificOperations(); CheckAdvSIMDEnabled();
    if quadword_operation then
        if d == m then
            Q[d>>1] = bits(128) UNKNOWN; Q[m>>1] = bits(128) UNKNOWN;
        else
            bits(256) zipped_q;
            for e = 0 to (128 DIV esize) - 1
                Elem[zipped_q,2*e,esize] = Elem[Q[d>>1],e,esize];
                Elem[zipped_q,2*e+1,esize] = Elem[Q[m>>1],e,esize];
            Q[d>>1] = zipped_q<127:0>; Q[m>>1] = zipped_q<255:128>;
    else
        if d == m then
            D[d] = bits(64) UNKNOWN; D[m] = bits(64) UNKNOWN;
        else
            bits(128) zipped_d;
            for e = 0 to (64 DIV esize) - 1
                Elem[zipped_d,2*e,esize] = Elem[D[d],e,esize];
                Elem[zipped_d,2*e+1,esize] = Elem[D[m],e,esize];
            D[d] = zipped_d<63:0>; D[m] = zipped_d<127:64>;
  
```

Exceptions

Undefined Instruction.

Pseudo-instructions

VZIP.32 <Dd>, <Dm> is a synonym for VTRN.32 <Dd>, <Dm>.

For details see *VTRN* on page A8-800.

A8.6.411 WFE

Wait For Event is a hint instruction that permits the processor to enter a low-power state until one of a number of events occurs, including events signaled by executing the SEV instruction on any processor in the multiprocessor system. For more information, see *Wait For Event and Send Event* on page B1-44.

Encoding T1 ARMv7 (executes as NOP in ARMv6T2)

WFE<c>

15	14	13	12	11	10	9	8	7	6	5	4	3	2	1	0
1	0	1	1	1	1	1	1	0	0	1	0	0	0	0	0

// No additional decoding required

Encoding T2 ARMv7 (executes as NOP in ARMv6T2)

WFE<c>.W

15	14	13	12	11	10	9	8	7	6	5	4	3	2	1	0	15	14	13	12	11	10	9	8	7	6	5	4	3	2	1	0
1	1	1	1	0	0	1	1	1	0	1	0	(1)	(1)	(1)	(1)	1	0	(0)	0	(0)	0	0	0	0	0	0	0	1	0		

// No additional decoding required

Encoding A1 ARMv6K, ARMv7 (executes as NOP in ARMv6T2)

WFE<c>

31	30	29	28	27	26	25	24	23	22	21	20	19	18	17	16	15	14	13	12	11	10	9	8	7	6	5	4	3	2	1	0	
cond	0	0	1	1	0	0	1	0	0	0	0	0	0	0	0	(1)	(1)	(1)	(1)	(0)	(0)	(0)	(0)	0	0	0	0	0	0	0	1	0

// No additional decoding required

Assembler syntax

WFE<c><q>

where:

<c><q> See *Standard assembler syntax fields* on page A8-7.

Operation

```
if ConditionPassed() then
    EncodingSpecificOperations();
    if EventRegistered() then
        ClearEventRegister();
    else
        WaitForEvent();
```

Exceptions

None.

A8.6.412 WFI

Wait For Interrupt is a hint instruction that permits the processor to enter a low-power state until one of a number of asynchronous events occurs. For details, see *Wait For Interrupt* on page B1-47.

Encoding T1 ARMv7 (executes as NOP in ARMv6T2)

WFI<c>

15	14	13	12	11	10	9	8	7	6	5	4	3	2	1	0
1	0	1	1	1	1	1	1	0	0	1	1	0	0	0	0

// No additional decoding required

Encoding T2 ARMv7 (executes as NOP in ARMv6T2)

WFI<c>.W

15	14	13	12	11	10	9	8	7	6	5	4	3	2	1	0	15	14	13	12	11	10	9	8	7	6	5	4	3	2	1	0
1	1	1	1	0	0	1	1	1	0	1	0	(1)	(1)	(1)	(1)	1	0	(0)	0	(0)	0	0	0	0	0	0	0	1	1		

// No additional decoding required

Encoding A1 ARMv6K, ARMv7 (executes as NOP in ARMv6T2)

WFI<c>

31	30	29	28	27	26	25	24	23	22	21	20	19	18	17	16	15	14	13	12	11	10	9	8	7	6	5	4	3	2	1	0	
cond	0	0	1	1	0	0	1	0	0	0	0	0	0	0	0	(1)	(1)	(1)	(1)	(0)	(0)	(0)	(0)	0	0	0	0	0	0	0	1	1

// No additional decoding required

Assembler syntax

WFI<c><q>

where:

<c><q> See *Standard assembler syntax fields* on page A8-7.

Operation

```
if ConditionPassed() then
    EncodingSpecificOperations();
    WaitForInterrupt();
```

Exceptions

None.

A8.6.413 YIELD

YIELD is a hint instruction. It enables software with a multithreading capability to indicate to the hardware that it is performing a task, for example a spin-lock, that could be swapped out to improve overall system performance. Hardware can use this hint to suspend and resume multiple code threads if it supports the capability.

Encoding T1 ARMv7 (executes as NOP in ARMv6T2)

YIELD<c>

15	14	13	12	11	10	9	8	7	6	5	4	3	2	1	0	
1	0	1	1	1	1	1	1	0	0	0	0	1	0	0	0	0

// No additional decoding required

Encoding T2 ARMv7 (executes as NOP in ARMv6T2)

YIELD<c>.W

15	14	13	12	11	10	9	8	7	6	5	4	3	2	1	0	15	14	13	12	11	10	9	8	7	6	5	4	3	2	1	0
1	1	1	1	1	0	0	1	1	1	0	1	0	(1)	(1)	(1)	(1)	(1)	1	0	(0)	0	(0)	0	0	0	0	0	0	0	0	1

// No additional decoding required

Encoding A1 ARMv6K, ARMv7 (executes as NOP in ARMv6T2)

YIELD<c>

31	30	29	28	27	26	25	24	23	22	21	20	19	18	17	16	15	14	13	12	11	10	9	8	7	6	5	4	3	2	1	0	
cond	0	0	1	1	0	0	1	0	0	0	0	0	0	0	0	(1)	(1)	(1)	(1)	(1)	(0)	(0)	(0)	(0)	0	0	0	0	0	0	0	1

// No additional decoding required

Assembler syntax

YIELD<c><q>

where:

<c><q> See *Standard assembler syntax fields* on page A8-7.

Operation

```
if ConditionPassed() then
    EncodingSpecificOperations();
    Hint_Yield();
```

Exceptions

None.

Chapter A9

ThumbEE

This chapter contains detailed reference material on ThumbEE.

It contains the following sections:

- *The ThumbEE instruction set* on page A9-2
- *ThumbEE instruction set encoding* on page A9-6
- *Additional instructions in Thumb and ThumbEE instruction sets* on page A9-7
- *ThumbEE instructions with modified behavior* on page A9-8
- *Additional ThumbEE instructions* on page A9-14.

A9.1 The ThumbEE instruction set

In general, instructions in ThumbEE are identical to Thumb instructions, with the following exceptions:

- A small number of instructions are affected by modifications to transitions from ThumbEE state. For more information, see *ThumbEE state transitions*.
- A substantial number of instructions have a null check on the base register before any other operation takes place, but are identical (or almost identical) in all other respects. For more information, see *Null checking* on page A9-3.
- A small number of instructions are modified in additional ways. See *Instructions with modifications* on page A9-4.
- Three Thumb instructions, BLX (immediate), 16-bit LDM, and 16-bit STM, are removed in ThumbEE state.

The encoding corresponding to BLX (immediate) in Thumb is UNDEFINED in ThumbEE state.

16-bit LDM and STM are replaced by new instructions, for details see *Additional ThumbEE instructions* on page A9-14.

- Two new 32-bit instructions, ENTERX and LEAVEX, are introduced in both the Thumb instruction set and the ThumbEE instruction set. See *Additional instructions in Thumb and ThumbEE instruction sets* on page A9-7. These instructions use previously UNDEFINED encodings.

A9.1.1 ThumbEE state transitions

Instruction set state transitions to ThumbEE state can occur implicitly as part of a return from exception, or explicitly on execution of an ENTERX instruction.

Instruction set state transitions from ThumbEE state can only occur due to an exception, or due to a transition to Thumb state using the LEAVEX instruction. Return from exception instructions (RFE and SUBS PC, LR, #imm) are UNPREDICTABLE in ThumbEE state.

Any other Thumb instructions that can update the PC in ThumbEE state are UNPREDICTABLE if they attempt to change to ARM state. Interworking of ARM and Thumb instructions is not supported in ThumbEE state. The instructions affected are:

- LDR, LDM, and POP instructions that write to the PC, if bit [0] of the value loaded to the PC is 0
- BLX (register), BX, and BXJ, where Rm bit [0] == 0.

————— Note —————

SVC, BKPT, and UNDEFINED instructions cause an exception to occur.

If a BXJ <Rm> instruction is executed in ThumbEE state, with Rm bit[0] == 1, it does not enter Jazelle state. Instead, it behaves like the corresponding BX <Rm> instruction and remains in ThumbEE state.

Debug state is a special case. For the rules governing changes to CPSR state bits and Debug state, see *Executing instructions in Debug state* on page C5-9.

A9.1.2 Null checking

A *null check* is performed for all load/store instructions when they are executed in ThumbEE state. If the value in the base register is zero, execution branches to the NullCheck handler at HandlerBase – 4.

For most load/store instructions, this is the only difference from normal Thumb operation. Exceptions to this rule are described in this chapter.

Note

- The null check examines the value in the base register, not any calculated value offset from the base register.
 - If the base register is the SP or the PC, a zero value in the base register results in UNPREDICTABLE behavior.
-

The instructions affected by null checking are:

- all instructions whose mnemonic starts with LD, ST, VLD or VST
- POP, PUSH, TBB, TBH, VPOP, and VPUSH.

For each of these instructions, the pseudocode shown in the Operation section uses the following function:

```
// NullCheckIfThumbEE()
// =====

NullCheckIfThumbEE(integer n)
  if CurrentInstrSet() == InstrSet_ThumbEE then
    if n == 15 then
      if IsZero(Align(PC,4)) then UNPREDICTABLE;
    elseif n == 13 then
      if IsZero(SP) then UNPREDICTABLE;
    else
      if IsZero(R[n]) then
        LR = PC<31:1> : '1'; // PC holds this instruction's address plus 4
        BranchWritePC(TEEHBR - 4);
        EndOfInstruction();
  return;
```

A9.1.3 Instructions with modifications

In addition to the instructions described in *ThumbEE state transitions* on page A9-2 and *Null checking* on page A9-3, Table A9-1 shows other instructions that are modified in ThumbEE state. The pseudocode, including the null check if any, is given in *ThumbEE instructions with modified behavior* on page A9-8.

Table A9-1 Modified instructions

Instructions	Rbase	Modification
LDR (register)	Rn	Rm multiplied by 4, null check
LDRH (register)	Rn	Rm multiplied by 2, null check
LDRSH (register)	Rn	Rm multiplied by 2, null check
STR (register)	Rn	Rm multiplied by 4, null check
STRH (register)	Rn	Rm multiplied by 2, null check

A9.1.4 IT block and check handlers

CHKa, stores, and permitted loads (loads to the PC are only permitted as the last instruction) can occur anywhere in an IT block. If one of these instructions results in a branch to the null pointer or array index handlers, the IT state bits in ITSTATE are cleared. This enables unconditional execution from the start of the handler.

The original IT state bits are not preserved.

A9.2 ThumbEE instruction set encoding

In general, instructions in the ThumbEE instruction set are encoded in exactly the same way as Thumb instructions described in Chapter A6 *Thumb Instruction Set Encoding*. The differences are as follows:

- There are no 16-bit LDM or STM instructions in the ThumbEE instruction set.
- The 16-bit encodings used for LDM and STM in the Thumb instruction set are used for different 16-bit instructions in the ThumbEE instruction set. For details, see *16-bit ThumbEE instructions*.
- There are two new 32-bit instructions in both Thumb state and ThumbEE state. For details, see *Additional instructions in Thumb and ThumbEE instruction sets* on page A9-7.

A9.2.1 16-bit ThumbEE instructions

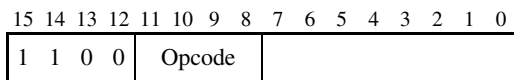

Table A9-2 shows the allocation of encodings in this space. ~~Other encodings in this space are UNDEFINED.~~

Table A9-2 16-bit ThumbEE instructions

Opcode	Instruction	See
0000	Handler Branch with Parameter	<i>HBP</i> on page A9-18
0001	UNDEFINED	
001x	Handler Branch, Handler Branch with Link	<i>HB</i> , <i>HBL</i> on page A9-16
01xx	Handler Branch with Link and Parameter	<i>HBLP</i> on page A9-17
100x	Load Register from a frame	<i>LDR (immediate)</i> on page A9-19
1010	Check Array	<i>CHKA</i> on page A9-15
1011	Load Register from a literal pool	<i>LDR (immediate)</i> on page A9-19
110x	Load Register (array operations)	<i>LDR (immediate)</i> on page A9-19
111x	Store Register to a frame	<i>STR (immediate)</i> on page A9-21

A9.3 Additional instructions in Thumb and ThumbEE instruction sets

On a processor with the ThumbEE extension, there are two additional 32-bit instructions, ENTERX and LEAVEX. These are available in both Thumb state and ThumbEE state.

A9.3.1 ENTERX, LEAVEX

ENTERX causes a change from Thumb state to ThumbEE state, or has no effect in ThumbEE state.

LEAVEX causes a change from ThumbEE state to Thumb state, or has no effect in Thumb state.

Encoding T1 ThumbEE

ENTERX Not permitted in IT block.

LEAVEX Not permitted in IT block.

15	14	13	12	11	10	9	8	7	6	5	4	3	2	1	0	15	14	13	12	11	10	9	8	7	6	5	4	3	2	1	0
1	1	1	1	0	0	1	1	1	0	1	1	(1)	(1)	(1)	(1)	1	0	(0)	0	(1)	(1)	(1)	(1)	0	0	0	J	(1)	(1)	(1)	(1)

is_enterx = (J == '1');

Assembler syntax

ENTERX<q> Encoded as J = 1

LEAVEX<q> Encoded as J = 0

where:

<q> See *Standard assembler syntax fields* on page A8-7. An ENTERX or LEAVEX instruction must be unconditional.

Operation

```
if is_enterx then
    SelectInstrSet(InstrSet_ThumbEE);
else
    SelectInstrSet(InstrSet_Thumb);
```

Exceptions

None.

A9.4 ThumbEE instructions with modified behavior

The 16-bit encodings of the following Thumb instructions have changed functionality in ThumbEE:

- *LDR (register)* on page A9-9
- *LDRH (register)* on page A9-10
- *LDRSH (register)* on page A9-11
- *STR (register)* on page A9-12
- *STRH (register)* on page A9-13.

In ThumbEE state there are the following changes in the behavior of instructions:

- All load/store instructions perform null checks on their base register values, as described in *Null checking* on page A9-3. The pseudocode for these instructions in Chapter A8 *Instruction Details* describes this by calling the `NullCheckIfThumbEE()` pseudocode procedure.
- Instructions that attempt to enter ARM state are UNPREDICTABLE, as described in *ThumbEE state transitions* on page A9-2. The pseudocode for these instructions in Chapter A8 *Instruction Details* describes this by calling the `SelectInstrSet()` or `BXWritePC()` pseudocode procedure.
- The *BXJ* instruction behaves like the *BX* instruction, as described in *ThumbEE state transitions* on page A9-2. The pseudocode for the instruction, in *BXJ* on page A8-64, describes this directly.

A9.4.1 LDR (register)

Load Register (register) calculates an address from a base register value and an offset register value, loads a word from memory, and writes it to a register. The offset register value is shifted left by 2 bits. For information about memory accesses see *Memory accesses* on page A8-13.

The similar Thumb instruction does not have a left shift.

Encoding T1 ThumbEE

LDR<c> <Rt>, [<Rn>, <Rm>, LSL #2]

15	14	13	12	11	10	9	8	7	6	5	4	3	2	1	0
0	1	0	1	1	0	0	Rm			Rn			Rt		

t = UInt(Rt); n = UInt(Rn); m = UInt(Rm);

Assembler syntax

LDR<c><q> <Rt>, [<Rn>, <Rm>, LSL #2]

where:

- <c><q> See *Standard assembler syntax fields* on page A8-7.
- <Rt> The destination register.
- <Rn> The base register.
- <Rm> Contains the offset that is shifted and applied to the value of <Rn> to form the address.

Operation

```
if ConditionPassed() then
    EncodingSpecificOperations();  NullCheckIfThumbEE(n);
    address = R[n] + LSL(R[m],2);
    R[t] = MemU[address,4];
```

Exceptions and checks

Data Abort, NullCheck.

A9.4.2 LDRH (register)

Load Register Halfword (register) calculates an address from a base register value and an offset register value, loads a halfword from memory, zero-extends it to form a 32-bit word, and writes it to a register. The offset register value is shifted left by 1 bit. For information about memory accesses see *Memory accesses* on page A8-13.

The similar Thumb instruction does not have a left shift.

Encoding T1 ThumbEE

LDRH<c> <Rt>, [<Rn>, <Rm>, LSL #1]

15	14	13	12	11	10	9	8	7	6	5	4	3	2	1	0
0	1	0	1	1	0	1	Rm			Rn			Rt		

t = UInt(Rt); n = UInt(Rn); m = UInt(Rm);

Assembler syntax

LDRH<c><q> <Rt>, [<Rn>, <Rm>, LSL #1]

where:

- <c><q> See *Standard assembler syntax fields* on page A8-7.
- <Rt> The destination register.
- <Rn> The base register.
- <Rm> Contains the offset that is shifted and applied to the value of <Rn> to form the address.

Operation

```
if ConditionPassed() then
    EncodingSpecificOperations(); NullCheckIfThumbEE(n);
    address = R[n] + LSL(R[m],1);
    R[t] = ZeroExtend(MemU[address,2], 32);
```

Exceptions and checks

Data Abort, NullCheck.

A9.4.3 LDRSH (register)

Load Register Signed Halfword (register) calculates an address from a base register value and an offset register value, loads a halfword from memory, sign-extends it to form a 32-bit word, and writes it to a register. The offset register value is shifted left by 1 bit. For information about memory accesses see *Memory accesses* on page A8-13.

The similar Thumb instruction does not have a left shift.

Encoding T1 ThumbEE

LDRSH<c> <Rt>, [<Rn>, <Rm>, LSL #1]

15	14	13	12	11	10	9	8	7	6	5	4	3	2	1	0
0	1	0	1	1	1	1	Rm	Rn	Rt						

t = UInt(Rt); n = UInt(Rn); m = UInt(Rm);

Assembler syntax

LDRSH<c><q> <Rt>, [<Rn>, <Rm>, LSL #1]

where:

<c><q> See *Standard assembler syntax fields* on page A8-7.

<Rt> The destination register.

<Rn> The base register.

<Rm> Contains the offset that is shifted and applied to the value of <Rn> to form the address.

Operation

```
if ConditionPassed() then
    EncodingSpecificOperations(); NullCheckIfThumbEE(n);
    address = R[n] + LSL(R[m],1);
    R[t] = SignExtend(MemU[address,2], 32);
```

Exceptions and checks

Data Abort, NullCheck.

A9.4.4 STR (register)

Store Register (register) calculates an address from a base register value and an offset register value, and stores a word from a register to memory. The offset register value is shifted left by 2 bits. For information about memory accesses see *Memory accesses* on page A8-13.

The similar Thumb instruction does not have a left shift.

Encoding T1 ThumbEE

STR<c> <Rt>, [<Rn>, <Rm>, LSL #2]

15	14	13	12	11	10	9	8	7	6	5	4	3	2	1	0
0	1	0	1	0	0	0	Rm			Rn			Rt		

t = UInt(Rt); n = UInt(Rn); m = UInt(Rm);

Assembler syntax

STR<c><q> <Rt>, [<Rn>, <Rm>, LSL #2]

where:

- <c><q> See *Standard assembler syntax fields* on page A8-7.
- <Rt> The source register.
- <Rn> The base register.
- <Rm> Contains the offset that is shifted and applied to the value of <Rn> to form the address.

Operation

```
if ConditionPassed() then
    EncodingSpecificOperations(); NullCheckIfThumbEE(n);
    address = R[n] + LSL(R[m],2);
    MemU[address,4] = R[t];
```

Exceptions and checks

Data Abort, NullCheck.

A9.4.5 STRH (register)

Store Register Halfword (register) calculates an address from a base register value and an offset register value, and stores a halfword from a register to memory. The offset register value is shifted left by 1 bit. For information about memory accesses see *Memory accesses* on page A8-13.

The similar Thumb instruction does not have a left shift.

Encoding T1 ThumbEE

STRH<c> <Rt>, [<Rn>, <Rm>, LSL #1]

15	14	13	12	11	10	9	8	7	6	5	4	3	2	1	0
0	1	0	1	0	0	1	Rm			Rn			Rt		

t = UInt(Rt); n = UInt(Rn); m = UInt(Rm);

Assembler syntax

STRH<c><q> <Rt>, [<Rn>, <Rm>, LSL #1]

where:

- <c><q> See *Standard assembler syntax fields* on page A8-7.
- <Rt> The source register.
- <Rn> The base register.
- <Rm> Contains the offset that is shifted and applied to the value of <Rn> to form the address.

Operation

```
if ConditionPassed() then
    EncodingSpecificOperations();  NullCheckIfThumbEE(n);
    address = R[n] + LSL(R[m],1);
    MemU[address,2] = R[t]<15:0>;
```

Exceptions and checks

Data Abort, NullCheck.

A9.5 Additional ThumbEE instructions

The following instructions are available in ThumbEE state, but not in Thumb state:

- *CHKA* on page A9-15
- *HB, HBL* on page A9-16
- *HBLP* on page A9-17
- *HBP* on page A9-18
- *LDR (immediate)* on page A9-19
- *STR (immediate)* on page A9-21.

These are 16-bit instructions. They occupy the instruction encoding space that STMIA and LDMIA occupy in Thumb state.

A9.5.1 CHKA

CHKA (Check Array) compares the unsigned values in two registers. If the first is lower than, or the same as, the second, it copies the PC to the LR, and causes a branch to the IndexCheck handler.

Encoding E1 ThumbEE

CHKA<c> <Rn>, <Rm>

15	14	13	12	11	10	9	8	7	6	5	4	3	2	1	0
1	1	0	0	1	0	1	0	N	Rm			Rn			

```
n = UInt(N:Rn); m = UInt(Rm);
if n == 15 || BadReg(m) then UNPREDICTABLE;
```

Assembler syntax

CHKA<c><q> <Rn>, <Rm>

where:

<c><q> See *Standard assembler syntax fields* on page A8-7.

<Rn> The first operand register. This contains the array size. Use of the SP is permitted.

<Rm> The second operand register. This contains the array index.

Operation

```
if ConditionPassed() then
    EncodingSpecificOperations();
    if UInt(R[n]) <= UInt(R[m]) then
        LR = PC<31:1> : '1'; // PC holds this instruction's address + 4
        BranchWritePC(TEEHBR - 8);
```

Exceptions and checks

IndexCheck.

Usage

Use CHKA to check that an array index is in bounds.

CHKA does not modify the APSR condition code flags.

A9.5.2 HB, HBL

Handler Branch branches to a specified handler.

Handler Branch with Link saves a return address to the LR, and then branches to a specified handler.

Encoding E1 ThumbEE

HB{L}<c> #<HandlerID>

15	14	13	12	11	10	9	8	7	6	5	4	3	2	1	0
1	1	0	0	0	0	1	L	handler							

generate_link = (L == '1'); handler_offset = ZeroExtend(handler:'00000', 32);

Assembler syntax

HB<c><q> #<HandlerID> Encoded as L = 0

HBL<c><q> #<HandlerID> Encoded as L = 1

where:

<c><q> See *Standard assembler syntax fields* on page A8-7.

<HandlerID> The index number of the handler to be called, in the range 0-255.

Operation

```
if ConditionPassed() then
    EncodingSpecificOperations();
    if generate_link then
        next_instr_addr = PC - 2;
        LR = next_instr_addr<31:1> : '1';
        BranchWritePC(TEEHBR + handler_offset);
```

Exceptions

None.

Usage

HB{L} makes a large number of handlers available.

A9.5.3 HBLP

HBLP (Handler Branch with Link and Parameter) saves a return address to the LR, and then branches to a specified handler. It passes a 5-bit parameter to the handler in R8.

Encoding E1 ThumbEE

HBLP<C> #<imm>, #<HandlerID>

15	14	13	12	11	10	9	8	7	6	5	4	3	2	1	0
1	1	0	0	0	1	imm5					handler				

imm32 = ZeroExtend(imm5, 32); handler_offset = ZeroExtend(handler:'00000', 32);

Assembler syntax

HBLP<C><Q> #<imm>, #<HandlerID>

where:

- <C><Q> See *Standard assembler syntax fields* on page A8-7.
- <imm> The parameter to pass to the handler, in the range 0-31.
- <HandlerID> The index number of the handler to be called, in the range 0-31.

Operation

```
if ConditionPassed() then
    EncodingSpecificOperations();
    R[8] = imm32;
    next_instr_addr = PC - 2;
    LR = next_instr_addr<31:1> : '1';
    BranchWritePC(TEEHBR + handler_offset);
```

Exceptions

None.

A9.5.4 HBP

HBP (Handler Branch with Parameter) causes a branch to a specified handler. It passes a 3-bit parameter to the handler in R8.

Encoding E1 ThumbEE

HBP<c> #<imm>, #<HandlerID>

15	14	13	12	11	10	9	8	7	6	5	4	3	2	1	0
1	1	0	0	0	0	0	0	imm3			handler				

```
imm32 = ZeroExtend(imm3, 32); handler_offset = ZeroExtend(handler:'00000', 32);
```

Assembler syntax

HBP<c><q> #<imm>, #<HandlerID>

where:

<c><q> See *Standard assembler syntax fields* on page A8-7.

<imm> The parameter to pass to the handler, in the range 0-7.

<HandlerID> The index number of the handler to be called, in the range 0-31.

Operation

```
if ConditionPassed() then
    EncodingSpecificOperations();
    R[8] = imm32;
    BranchWritePC(TEEHBR + handler_offset);
```

Exceptions

None.

A9.5.5 LDR (immediate)

Load Register (immediate) provides 16-bit instructions to load words using:

- R9 as base register, with a positive offset of up to 63 words, for loading from a frame
- R10 as base register, with a positive offset of up to 31 words, for loading from a literal pool
- R0-R7 as base register, with a negative offset of up to 7 words, for array operations.

Encoding E1 ThumbEE

LDR<c> <Rt>, [R9{, #<imm>}]

15	14	13	12	11	10	9	8	7	6	5	4	3	2	1	0
1	1	0	0	1	1	0	imm6					Rt			

t = UInt(Rt); n = 9; imm32 = ZeroExtend(imm6:'00', 32); add = TRUE;

Encoding E2 ThumbEE

LDR<c> <Rt>, [R10{, #<imm>}]

15	14	13	12	11	10	9	8	7	6	5	4	3	2	1	0	
1	1	0	0	1	0	1	1	imm5					Rt			

t = UInt(Rt); n = 10; imm32 = ZeroExtend(imm5:'00', 32); add = TRUE;

Encoding E3 ThumbEE

LDR<c> <Rt>, [<Rn>{, #-<imm>}]

15	14	13	12	11	10	9	8	7	6	5	4	3	2	1	0
1	1	0	0	1	0	0	imm3			Rn		Rt			

t = UInt(Rt); n = UInt(Rn); imm32 = ZeroExtend(imm3:'00', 32); add = FALSE;

Assembler syntax

```
LDR<c><q> <Rt>, [<Rn>{, #<imm>}]
```

where:

- <c><q> See *Standard assembler syntax fields* on page A8-7.
- <Rt> The destination register.
- <Rn> The base register. This register is:
- R9 for encoding E1
 - R10 for encoding E2
 - any of R0-R7 for encoding E3.
- <imm> The immediate offset used to form the address. Values are multiples of 4 in the range:
- | | |
|-------|--------------|
| 0-252 | encoding E1 |
| 0-124 | encoding E2 |
| -28-0 | encoding E3. |
- <imm> can be omitted, meaning an offset of 0.

Operation

```
if ConditionPassed() then
    EncodingSpecificOperations(); NullCheckIfThumbEE(n);
    address = if add then (R[n] + imm32) else (R[n] - imm32);
    R[t] = MemU[address,4];
```

Exceptions and checks

Data Abort, NullCheck.

A9.5.6 STR (immediate)

Store Register (immediate) provides a 16-bit word store instruction using R9 as base register, with a positive offset of up to 63 words, for storing to a frame.

Encoding E1 ThumbEE

STR<c> <Rt>, [R9, #<imm>]

15	14	13	12	11	10	9	8	7	6	5	4	3	2	1	0
1	1	0	0	1	1	1	imm6						Rt		

```
t = UInt(Rt); imm32 = ZeroExtend(imm6:'00', 32);
```

Assembler syntax

STR<c><q> <Rt>, [R9, #<imm>]

where:

<c><q> See *Standard assembler syntax fields* on page A8-7.

<Rt> The source register.

<imm> The immediate offset applied to the value of R9 to form the address. Values are multiples of 4 in the range 0-252.

<imm> can be omitted, meaning an offset of 0.

Operation

```
if ConditionPassed() then
    EncodingSpecificOperations(); NullCheckIfThumbEE(9);
    address = R[9] + imm32;
    MemU[address,4] = R[t];
```

Exceptions and checks

Data Abort, NullCheck.

Part B

System Level Architecture

Chapter B1

The System Level Programmers' Model

This chapter provides a system-level view of the programmers' model. It contains the following sections:

- *About the system level programmers' model* on page B1-2
- *System level concepts and terminology* on page B1-3
- *ARM processor modes and core registers* on page B1-6
- *Instruction set states* on page B1-23
- *The Security Extensions* on page B1-25
- *Exceptions* on page B1-30
- *Coprocessors and system control* on page B1-62
- *Advanced SIMD and floating-point support* on page B1-64
- *Execution environment support* on page B1-73.

B1.1 About the system level programmers' model

An application programmer has only a restricted view of the system. The system level programmers' model supports this application level view of the system, and includes features required for an operating system (OS) to provide the programming environment seen by an application.

The system level programmers' model includes all of the system features required to support operating systems and to handle hardware events.

System level concepts and terminology on page B1-3 gives a system level introduction to the basic concepts of the ARM architecture, and the terminology used to describe the architecture. The rest of this chapter describes the system level programmers' model.

The other chapters in this part describe:

- The memory system architectures:
 - Chapter B2 *Common Memory System Architecture Features* describes common features of the memory system architectures
 - Chapter B3 *Virtual Memory System Architecture (VMSA)* describes the *Virtual Memory System Architecture* (VMSA) used in the ARMv7-A profile
 - Chapter B4 *Protected Memory System Architecture (PMSA)* describes the *Protected Memory System Architecture* (PMSA) used in the ARMv7-R profile.
- The CPUID mechanism, that enables an OS to determine the capabilities of the processor it is running on. See Chapter B5 *The CPUID Identification Scheme*.
- The instructions that provide system-level functionality, such as returning from an exception. See Chapter B6 *System Instructions*.

B1.2 System level concepts and terminology

A number of concepts are critical to understanding the system level architecture support. These are introduced in the following sections:

- *Privilege, mode, and state*
- *Exceptions* on page B1-4

B1.2.1 Privilege, mode, and state

Privilege, mode, and state are key concepts in the ARM architecture.

Privilege

Software can execute as privileged or unprivileged:

- Unprivileged execution limits or excludes access to some resources in the current security state.
- Privileged execution gives access to all resources in the current security state.

Mode

The ARM architecture provides a set of modes that support normal software execution and handle exceptions. The current mode determines the set of registers that are available and the privilege of the executing software. For more information, see *ARM processor modes and core registers* on page B1-6.

State

In the ARM architecture, *state* is used to describe the following distinct concepts:

Instruction set state

ARMv7 provides four instruction set states. The instruction set state determines the instruction set that is being executed, and is one of ARM state, Thumb state, Jazelle state, or ThumbEE state. *ISETSTATE* on page A2-15 gives more information about these states.

Execution state

The execution state consists of the instruction set state and some control bits that modify how the instruction stream is decoded. For details, see *Execution state registers* on page A2-15 and *Program Status Registers (PSRs)* on page B1-14.

Security state In the ARM architecture, the number of security states depends on whether the Security Extensions are implemented:

- When the Security Extensions are implemented, the ARM architecture provides two security states, Secure state and Non-secure state. Each security state has its own system registers and memory address space.

The security state is largely independent of the processor mode. The only exception to this independence of security state and processor mode is Monitor mode. Monitor mode exists only in the Secure state, and supports transitions between Secure and Non-secure state.

Some system control resources are only accessible from the Secure state.

For more information, see *The Security Extensions* on page B1-25.

———— **Note** ————

In some documentation, the Secure state is described as the *Secure world*, and the Non-secure state is described as the *Non-secure world*.

- When the Security Extensions are not implemented, the ARM architecture provides only a single security state.

Debug state Debug state refers to the processor being halted for debug purposes, because a debug event has occurred when the processor is configured to Halting debug-mode. See *Invasive debug* on page C1-3.

When the processor is not in Debug state it is in Non-debug state.

Except where explicitly stated otherwise, parts A and B of this manual describe processor behavior and instruction execution in Non-debug state. Chapter C5 *Debug State* describes the differences in Debug state.

B1.2.2 Exceptions

An exception is a condition that changes the normal flow of control in a program. The change of flow switches execution to an exception handler, and the state of the system at the point where the exception occurred is presented to the exception handler. A key component of the state presented to the handler is the return address, that indicates the point in the instruction stream where the exception was taken.

The ARM architecture provides a number of different exceptions as described in *Exceptions* on page B1-30.

Terminology for describing exceptions

In this manual, a number of terms have specific meanings when used to describe exceptions:

- An exception is *generated* in one of the following ways:
 - Directly as a result of the execution or attempted execution of the instruction stream. For example, an exception is generated as a result of an UNDEFINED instruction.
 - Less directly, as a result of something in the state of the system. For example, an exception is generated as a result of an interrupt signaled by a peripheral.
- An exception is *taken* by a processor at the point where it causes a change to the normal flow of control in the program.

- An exception is described as *synchronous* if both of the following apply:
 - the exception is generated as a result of direct execution or attempted execution of the instruction stream
 - the return address presented to the exception handler is guaranteed to indicate the instruction that caused the exception.
- An exception is described as *asynchronous* if either of the following applies:
 - the exception is not generated as a result of direct execution or attempted execution of the instruction stream
 - the return address presented to the exception handler is not guaranteed to indicate the instruction that caused the exception.

Asynchronous exceptions are of two types:

- a *precise asynchronous exception* guarantees that the state presented to the exception handler is consistent with the state at an identifiable instruction boundary in the execution stream from which the exception was taken.
- an *imprecise asynchronous exception* is one where the state presented to the exception handler is not guaranteed to be consistent with any point in the execution stream from which the exception was taken.

B1.3 ARM processor modes and core registers

The following sections describe the ARM processor modes and the core registers:

- *ARM processor modes*
- *ARM core registers* on page B1-9
- *Program Status Registers (PSRs)* on page B1-14.

B1.3.1 ARM processor modes

The ARM architecture defines eight modes, shown in Table B1-1:

Table B1-1 ARM processor modes

Processor mode ^a	Mode encoding ^b	Privilege	Description
User	usr 10000	Unprivileged	Suitable for most application code.
FIQ	fiq 10001	Privileged	Entered as a result of a fast interrupt. ^c
IRQ	irq 10010	Privileged	Entered as a result of a normal interrupt. ^c
Supervisor	svc 10011	Privileged	Suitable for running most kernel code. Entered on Reset, and on execution of a Supervisor Call (SVC) instruction.
Monitor ^d	mon 10110	Privileged	A Secure mode that enables change between Secure and Non-secure states, and can also be used to handle any of FIQs, IRQs and external aborts. ^c Entered on execution of a Secure Monitor Call (SMC) instruction.
Abort	abt 10111	Privileged	Entered as a result of a Data Abort exception or Prefetch Abort exception. ^c
Undefined	und 11011	Privileged	Entered as a result of an instruction-related error.
System	sys 11111	Privileged	Suitable for application code that requires privileged access.

- Processor mode names and abbreviations.
- CPSR.M. All other values are reserved. When the Security Extensions are not implemented the Monitor mode encoding, 0b10110, is reserved.
- Bits in the Secure Configuration Register can be set so that one or more of FIQs, IRQs and external aborts are handled in Monitor mode, see *c1, Secure Configuration Register (SCR)* on page B3-106.
- Only supported when the Security Extensions are implemented.

Mode changes can be made under software control, or can be caused by an external or internal exception.

Notes on the ARM processor modes

User mode User mode enables the operating system to restrict the use of system resources. Application programs normally execute in User mode. In User mode, the program being executed:

- cannot access protected system resources
- cannot change mode except by causing an exception, see *Exceptions* on page B1-30.

Privileged modes

The modes other than User mode are known as *privileged modes*. In their security state they have full access to system resources and can change mode freely.

Exception modes

The exception modes are:

- FIQ mode
- IRQ mode
- Supervisor mode
- Abort mode
- Undefined mode
- Monitor mode.

Each of these modes normally handles the corresponding exceptions, as shown in Table B1-1 on page B1-6.

Each exception mode has some banked registers to avoid corrupting the registers of the mode in use when the exception is taken, see *ARM core registers* on page B1-9.

System mode System mode has the same registers available as User mode, and is not entered by any exception.

System mode is intended for use by operating system tasks that must access system resources, but do not want to use the exception entry mechanism and the associated additional registers. Also, it is used when the operating system has to access the User mode registers.

Monitor mode

Monitor mode is only implemented as part of the Security Extensions, and is always in the Secure state, regardless of the value of the SCR.NS bit. For more information, see *The Security Extensions* on page B1-25.

Code running in Monitor mode has access to both the Secure and Non-secure copies of system registers. This means Monitor mode provides the normal method of changing between the Secure and Non-secure security states.

Secure and Non-secure modes

In a processor that implements the Security Extensions, a mode description can be qualified as Secure or Non-secure, to indicate whether the processor is also in Secure state or Non-secure state. For example:

- if a processor is in a privileged mode and Secure state, it is in a *Secure privileged mode*
- if a processor is in User mode and Non-secure state, it is in *Non-secure User mode*.

Pseudocode details of mode operations

The BadMode() function tests whether a 5-bit mode number corresponds to one of the permitted modes:

```
// BadMode()
// =====

boolean BadMode(bits(5) mode)
    case mode of
        when '10000' result = FALSE;           // User mode
        when '10001' result = FALSE;           // FIQ mode
        when '10010' result = FALSE;           // IRQ mode
        when '10011' result = FALSE;           // Supervisor mode
        when '10110' result = !HaveSecurityExt(); // Monitor mode
        when '10111' result = FALSE;           // Abort mode
        when '11011' result = FALSE;           // Undefined mode
        when '11111' result = FALSE;           // System mode
        otherwise result = TRUE;
    return result;
```

The following pseudocode functions provide information about the current mode:

```
// CurrentModeIsPrivileged()
// =====

boolean CurrentModeIsPrivileged()
    if BadMode(CPSR.M) then UNPREDICTABLE;
    if CPSR.M == '10000' then return FALSE; // User mode
    return TRUE;                             // Other modes

// CurrentModeIsUserOrSystem()
// =====

boolean CurrentModeIsUserOrSystem()
    if BadMode(CPSR.M) then UNPREDICTABLE;
    if CPSR.M == '10000' then return TRUE; // User mode
    if CPSR.M == '11111' then return TRUE; // System mode
    return FALSE;                           // Other modes
```

B1.3.2 ARM core registers

ARM core registers on page A2-11 describes the application level view of the ARM register file. This view provides 16 ARM core registers, R0 to R15, that include the *Stack Pointer* (SP), *Link Register* (LR), and *Program Counter* (PC). These registers are selected from a total set of either 31 or 33 registers, depending on whether or not the Security Extensions are implemented. The current execution mode determines the selected set of registers, as shown in Figure B1-1. This shows that the arrangement of the registers provides duplicate copies of some registers, with the current register selected by the execution mode. This arrangement is described as *banking* of the registers, and the duplicated copies of registers are referred to as *banked registers*:

Application level view	System level views							
	Privileged modes							
	Exception modes							
	User mode	System mode	Supervisor mode	Monitor mode ‡	Abort mode	Undefined mode	IRQ mode	FIQ mode
R0	R0_usr							
R1	R1_usr							
R2	R2_usr							
R3	R3_usr							
R4	R4_usr							
R5	R5_usr							
R6	R6_usr							
R7	R7_usr							
R8	R8_usr							R8_fiq
R9	R9_usr							R9_fiq
R10	R10_usr							R10_fiq
R11	R11_usr							R11_fiq
R12	R12_usr							R12_fiq
SP	SP_usr		SP_svc	SP_mon ‡	SP_abt	SP_und	SP_irq	SP_fiq
LR	LR_usr		LR_svc	LR_mon ‡	LR_abt	LR_und	LR_irq	LR_fiq
PC	PC							
APSR	CPSR							
			SPSR_svc	SPSR_mon ‡	SPSR_abt	SPSR_und	SPSR_irq	SPSR_fiq

‡ Monitor mode, and the associated banked registers, are implemented only as part of the Security Extensions

Figure B1-1 Organization of general-purpose registers and Program Status Registers

Figure B1-1 includes the views of the *Current Program Status Register* (CPSR) and of the banked *Saved Program Status Register* (SPSR), see *Program Status Registers (PSRs)* on page B1-14.

Note

- System level register names, such as R0_usr, R8_usr, and R8_fiq, are used when it is necessary to identify a specific register. The Application level names refer to the registers for the current mode, and usually are sufficient to identify a register.
 - In ARMv7, the Security Extensions can be implemented only as part of an ARMv7-A implementation.
-

Each of the exception modes selects a different copy of the banked SP and LR, because these registers have special functions on exception entry:

- SP** This enables the exception handler to use a different stack to the one in use when the exception occurred. For example, it can use a stack in privileged memory rather than one in unprivileged memory.
- LR** The exception return address is placed in the banked LR of the exception mode. This means the use of the LR by the application is not corrupted. The address placed in the banked LR is at an exception-dependent offset from the next instruction to be executed in the code in which the exception occurred. This address enables the exception handler to return to that code, so the processor can resume execution of the code. Table B1-4 on page B1-34 shows the LR value saved on entry to each of the exception modes.

In addition:

- FIQ mode provides its own mappings for the general-purpose registers R8 to R12. These enable very fast processing of interrupts that are simple enough to be processed using only registers R8 to R12, SP, LR, and PC, without affecting the corresponding registers of the mode in which the interrupt was taken.
- In an exception mode the processor can access the SPSR for that mode. There is no SPSR for User mode and System mode.

In all ARMv7-A and ARMv7-R implementations:

- Every mode except User mode is *privileged*.
- User mode and System mode share the same register file. The only difference between System and User modes is that System mode runs with privileged access.

For more information about the application level view of the SP, LR, and the Program Counter (PC), and the alternative descriptions of them as R13, R14 and R15, see *ARM core registers* on page A2-11.

Writing to the PC

In ARMv7, instruction writes to the PC are handled as follows:

- Exception return instructions write both the PC and the CPSR. The value written to the CPSR determines the new instruction set state, and the value written to the PC determines the address that is branched to. For full details, including which instructions are exception return instructions and how incorrectly aligned PC values are handled, see *Exception return* on page B1-38.
- The following two 16-bit Thumb instruction encodings remain in Thumb state and branch to a value written to the PC:
 - encoding T2 of *ADD (register)* on page A8-24
 - encoding T1 of *MOV (register)* on page A8-196.

The value written to the PC is forced to be halfword-aligned by ignoring its least significant bit, instead treating that bit as being 0.

- The following instructions remain in the same instruction set state and branch to a value written to the PC:
 - B, BL, CBNZ, CBZ, CHKA, HB, HBL, HBLP, HBP, TBB, and TBH
 - in ThumbEE state, load/store instructions that fail their null check.

The definition of each of these instructions ensures that the value written to the PC is correctly aligned for the current instruction set state.

- The BLX (immediate) instruction switches between ARM and Thumb states and branches to a value written to the PC. Its definition ensures that the value written to the PC is correctly aligned for the new instruction set state.
- The following instructions write a value to the PC, treating that value as an interworking address with low-order bits that determine the new instruction set state and an address to branch to:
 - BLX (register), BX, and BXJ
 - LDR, ~~and~~ LDRT instructions with <Rt> equal to the PC
 - POP and all forms of LDM except LDM (exception return), when the register list includes the PC
 - in ARM state only, ADC, ADD, ADR, AND, ASR (immediate), BIC, EOR, LSL (immediate), LSR (immediate), MOV, MVN, ORR, ROR (immediate), RRX, RSB, RSC, SBC, and SUB instructions with <Rd> equal to the PC and without flag setting specified.

For details of how an interworking address specifies the new instruction set state and instruction address, see *Pseudocode details of operations on ARM core registers* on page A2-12.

———— Note —————

- The LDR, LDRT, POP, and LDM instructions first have this behavior in ARMv5T.
- The instructions listed as having this behavior in ARM state only first have this behavior in ARMv7.

In both cases, the behavior in earlier architecture versions is a branch that remains in the same instruction set state. For more information, see:

- *Interworking* on page AppxG-4, for ARMv6
- *Interworking* on page AppxH-5, for ARMv5 and ARMv4.

Pseudocode details of ARM core register operations

The following pseudocode gives access to the general-purpose registers:

```
// The names of the banked core registers.

enumeration RName {RName_0usr, RName_1usr, RName_2usr, RName_3usr, RName_4usr, RName_5usr,
    RName_6usr, RName_7usr, RName_8usr, RName_8fiq, RName_9usr, RName_9fiq,
    RName_10usr, RName_10fiq, RName_11usr, RName_11fiq, RName_12usr, RName_12fiq,
    RName_SPusr, RName_SPfiq, RName_SPirq, RName_SPsvc,
    RName_SPabt, RName_SPund, RName_SPmon,
    RName_LRusr, RName_LRfiq, RName_LRirq, RName_LRsvc,
    RName_LRabt, RName_LRund, RName_LRmon,
    RName_PC};

// The physical array of banked core registers.
//
// _R[RName_PC] is defined to be the address of the current instruction. The
// offset of 4 or 8 bytes is applied to it by the register access functions.

array bits(32) _R[RName];

// RBankSelect()
// =====

RName RBankSelect(bits(5) mode, RName usr, RName fiq, RName irq,
    RName svc, RName abt, RName und, RName mon)
if BadMode(mode) then
    UNPREDICTABLE;
else
    case mode of
        when '10000' result = usr; // User mode
        when '10001' result = fiq; // FIQ mode
        when '10010' result = irq; // IRQ mode
        when '10011' result = svc; // Supervisor mode
        when '10110' result = mon; // Monitor mode
        when '10111' result = abt; // Abort mode
        when '11011' result = und; // Undefined mode
        when '11111' result = usr; // System mode uses User mode registers
    return result;

// RfiqBankSelect()
// =====

RName RfiqBankSelect(bits(5) mode, RName usr, RName fiq)
    return RBankSelect(mode, usr, fiq, usr, usr, usr, usr);
```

```

// LookUpRName()
// =====

RName LookUpRName(integer n, bits(5) mode)
    assert n >= 0 && n <= 14;
    case n of
        when 0    result = RName_0usr;
        when 1    result = RName_1usr;
        when 2    result = RName_2usr;
        when 3    result = RName_3usr;
        when 4    result = RName_4usr;
        when 5    result = RName_5usr;
        when 6    result = RName_6usr;
        when 7    result = RName_7usr;
        when 8    result = RfiqBankSelect(mode, RName_8usr, RName_8fiq);
        when 9    result = RfiqBankSelect(mode, RName_9usr, RName_9fiq);
        when 10   result = RfiqBankSelect(mode, RName_10usr, RName_10fiq);
        when 11   result = RfiqBankSelect(mode, RName_11usr, RName_11fiq);
        when 12   result = RfiqBankSelect(mode, RName_12usr, RName_12fiq);
        when 13   result = RBankSelect(mode, RName_SPusr, RName_SPfiq, RName_SPIrq,
                                        RName_SPsvc, RName_SPabt, RName_SPund, RName_SPmon);
        when 14   result = RBankSelect(mode, RName_LRusr, RName_LRfiq, RName_LRirq,
                                        RName_LRsvc, RName_LRabt, RName_LRund, RName_LRmon);

    return result;

// Rmode[] - non-assignment form
// =====

bits(32) Rmode[integer n, bits(5) mode]
    assert n >= 0 && n <= 14;

    // In Non-secure state, check for attempted use of Monitor mode ('10110'), or of FIQ
    // mode ('10001') when the Security Extensions are reserving the FIQ registers. The
    // definition of UNPREDICTABLE does not permit this to be a security hole.
    if !IsSecure() && mode == '10110' then UNPREDICTABLE;
    if !IsSecure() && mode == '10001' && NSACR.RFR == '1' then UNPREDICTABLE;

    return _R[LookUpRName(n,mode)];

// Rmode[] - assignment form
// =====

Rmode[integer n, bits(5) mode] = bits(32) value
    assert n >= 0 && n <= 14;

    // In Non-secure state, check for attempted use of Monitor mode ('10110'), or of FIQ
    // mode ('10001') when the Security Extensions are reserving the FIQ registers. The
    // definition of UNPREDICTABLE does not permit this to be a security hole.
    if !IsSecure() && mode == '10110' then UNPREDICTABLE;
    if !IsSecure() && mode == '10001' && NSACR.RFR == '1' then UNPREDICTABLE;

    // Writes of non word-aligned values to SP are only permitted in ARM state.
    if n == 13 && value<1:0> != '00' && CurrentInstrSet() != InstrSet_ARM then UNPREDICTABLE;

```

```

    _R[LookUpRName(n,mode)] = value;
    return;

// R[] - non-assignment form
// =====

bits(32) R[integer n]
    assert n >= 0 && n <= 15;
    if n == 15 then
        offset = if CurrentInstrSet() == InstrSet_ARM then 8 else 4;
        result = _R[RName_PC] + offset;
    else
        result = Rmode[n, CPSR.M];
    return result;

// R[] - assignment form
// =====

R[integer n] = bits(32) value
    assert n >= 0 && n <= 14;
    Rmode[n, CPSR.M] = value;
    return;

// BranchTo()
// =====

BranchTo(bits(32) address)
    _R[RName_PC] = address;
    return;

```

B1.3.3 Program Status Registers (PSRs)

The application level programmers' model provides the Application Program Status Register, see *The Application Program Status Register (APSR)* on page A2-14. This is an application level alias for the *Current Program Status Register (CPSR)*. The system level view of the CPSR extends the register, adding system level information.

Each of the exception modes has its own saved copy of the CPSR, the *Saved Program Status Register (SPSR)*, as shown in Figure B1-1 on page B1-9. For example, the SPSR for Monitor mode is called SPSR_mon.

The Current Program Status Register (CPSR)

The *Current Program Status Register (CPSR)* holds processor status and control information:

- the APSR, see *The Application Program Status Register (APSR)* on page A2-14
- the current instruction set state, see *ISSETSTATE* on page A2-15
- the execution state bits for the Thumb If-Then instruction, see *ITSTATE* on page A2-17
- the current endianness, see *ENDIANSTATE* on page A2-19
- the current processor mode

- interrupt and asynchronous abort disable bits.

The non-APSR bits of the CPSR have defined reset values. These are shown in the `TakeReset()` pseudocode function, see *Reset* on page B1-48.

Writes to the CPSR have side-effects on various aspects of processor operation. All of these side-effects, except for those on memory accesses caused by fetching instructions, are synchronous to the CPSR write. This means they are guaranteed not to be visible to earlier instructions in the execution stream, and they are guaranteed to be visible to later instructions in the execution stream.

Fetching an instruction causes an instruction fetch memory access. In addition, in a Virtual Memory System Architecture (VMSA) implementation, fetching an instruction can cause a translation table walk. The privilege of these memory accesses can be affected by changes to the mode field of the CPSR. Also, if the Security Extensions are implemented the virtual memory space of these accesses can be affected by changes to the mode field. Those mode changes take effect on the memory accesses as follows:

- A mode change by an exception entry is synchronous to the exception entry. This applies to all exception entries, including the exception entry for a synchronous exception generated directly by an instruction.
- A mode change by an exception return instruction is synchronous to the instruction.
- A mode change by an instruction other than an exception return and that is not the result of a synchronous exception generated directly by the instruction. Such a mode change can be the result of a CPS or MSR instructions, and:
 - is guaranteed not to be visible to memory accesses caused by fetching earlier instructions in the execution stream
 - is guaranteed to be visible to memory accesses caused by fetching instructions after the next exception entry, exception return instruction, or ISB instruction in the execution stream
 - might or might not affect memory accesses caused by fetching instructions between the mode change instruction and the point where mode changes are guaranteed to be visible.

See *Exception return* on page B1-38 for the definition of exception return instructions.

The Saved Program Status Registers (SPSRs)

The purpose of an SPSR is to record the pre-exception value of the CPSR. When taking an exception, the processor copies the CPSR to the SPSR of the exception mode it is about to enter. Saving this value means the exception handler can:

- on exception return, restore the CPSR to the value it had when the exception was taken
- examine the value the CPSR had when the exception was taken, for example to determine the instruction set state in which the instruction that caused an Undefined Instruction exception was executed.

The SPSRs do not have defined reset values.

Format of the CPSR and SPSRs

The format of the CPSR and SPSRs is:

31	30	29	28	27	26	25	24	23	20	19	16	15	10	9	8	7	6	5	4	0	
N	Z	C	V	Q	IT [1:0]	J	Reserved	GE[3:0]	IT[7:2]					E	A	I	F	T	M[4:0]		

Condition code flags, bits [31:28]

Set on the result of instruction execution. The flags are:

N, bit [31] Negative condition code flag

Z, bit [30] Zero condition code flag

C, bit [29] Carry condition code flag

V, bit [28] Overflow condition code flag.

The condition code flags can be read or written in any mode, and are described in *The Application Program Status Register (APSR)* on page A2-14.

Q, bit [27] Cumulative saturation flag. This flag can be read or written in any mode, and is described in *The Application Program Status Register (APSR)* on page A2-14.

IT[7:0], bits [15:10,26:25]

If-Then execution state bits for the Thumb IT (If-Then) instruction. *ITSTATE* on page A2-17 describes the encoding of these bits. CPSR.IT[7:0] are the IT[7:0] bits described there. For more information, see *IT* on page A8-104.

For details of how these bits can be accessed see *Accessing the execution state bits* on page B1-18.

J, bit [24] Jazelle bit, see the description of the T bit, bit [5].

Bits [23:20] Reserved. RAZ/SBZP.

GE[3:0], bits [19:16]

Greater than or Equal flags, for SIMD instructions.

The GE[3:0] field can be read or written in any mode, and is described in *The Application Program Status Register (APSR)* on page A2-14.

E, bit [9] Endianness execution state bit. Controls the load and store endianness for data accesses:

0 Little endian operation

1 Big endian operation.

This bit is ignored by instruction fetches.

ENDIANSTATE on page A2-19 describes the encoding of this bit. CPSR.E is the ENDIANSTATE bit described there.

For details of how this bit can be accessed see *Accessing the execution state bits* on page B1-18.

Mask bits, bits [8:6]

The mask bits disable some asynchronous exceptions. The three mask bits are:

A, bit [8] Asynchronous abort disable bit. Used to mask asynchronous aborts.

I, bit [7] Interrupt disable bit. Used to mask IRQ interrupts.

F, bit [6] Fast interrupt disable bit. Used to mask FIQ interrupts.

The possible values of each bit are:

0 Exception enabled

1 Exception disabled.

The mask bits can be written only in privileged modes. Their values can be read in any mode, but use of their values and attempts to change them by User mode code are deprecated.

Updates to the F bit are restricted if Non-maskable Fast Interrupts (NMFI) are supported, see *Non-maskable fast interrupts* on page B1-18.

If implemented, the Security Extensions can restrict updates to the A and F bits from the Non-secure state, see *Use of the A, F, and Mode bits by the Security Extensions* on page B1-19.

T, bit [5]

Thumb execution state bit. This bit and the J execution state bit, bit [24], determine the instruction set state of the processor, ARM, Thumb, Jazelle, or ThumbEE. *ISETSTATE* on page A2-15 describes the encoding of these bits. CPSR.J and CPSR.T are the same bits as ISETSTATE.J and ISETSTATE.T respectively. For more information, see *Instruction set states* on page B1-23.

For details of how these bits can be accessed see *Accessing the execution state bits* on page B1-18.

M[4:0], bits [4:0]

Mode field. This field determines the current mode of the processor. The permitted values of this field are listed in Table B1-1 on page B1-6. All other values of M[4:0] are reserved. The effect of setting M[4:0] to a reserved value is UNPREDICTABLE.

For more information about the processor modes see *ARM processor modes* on page B1-6. Figure B1-1 on page B1-9 shows the registers that can be accessed in each mode.

This field can be written only in privileged modes. Its value can be read in any mode, but use of its value and attempts to change it by User mode code are deprecated.

If implemented, the Security Extensions restrict use of the mode field to enter Monitor and FIQ modes, see *Use of the A, F, and Mode bits by the Security Extensions* on page B1-19.

Accessing the execution state bits

The execution state bits are the IT[7:0], J, E, and T bits. In exception modes you can read or write these bits in the current SPSR.

In the CPSR, unless the processor is in Debug state:

- The execution state bits, other than the E bit, are RAZ when read by an MRS instruction.
- Writes to the execution state bits, other than the E bit, by an MSR instruction are:
 - For ARMv7 and ARMv6T2, ignored in all modes.
 - For architecture variants before ARMv6T2, ignored in User mode and required to write zeros in privileged modes. If a nonzero value is written in a privileged mode, behavior is UNPREDICTABLE.

Instructions other than MRS and MSR that access the execution state bits can read and write them in any mode.

Unlike the other execution state bits in the CPSR, CPSR.E can be read by an MRS instruction and written by an MSR instruction. However, using the CPSR.E value read by an MRS instruction is deprecated, and using an MSR instruction to change the value of CPSR.E is deprecated.

Note

- Use the SETEND instruction to change the current endianness.
- To determine the current endianness, use an LDR instruction to load a word of memory whose value is known and will differ if the endianness is reversed. For example, use an LDR (literal) instruction to load a word whose four bytes are 0x01, 0x00, 0x00, and 0x00 in ascending order of memory address. The LDR instruction loads the destination register with:
 - 0x00000001 if the current endianness is little-endian
 - 0x01000000 if the current endianness is big-endian.

For more information about the behavior of these bits in Debug state see *Behavior of the PC and CPSR in Debug state* on page C5-7.

Non-maskable fast interrupts

~~Exceptions, debug events and checks on page A2-81 introduces the two levels of external interrupts to an ARM processor, Interrupt Requests or IRQs and higher priority Fast Interrupt Requests or FIQs. Both IRQs and FIQs can be masked by bits in the CPSR, see *Program Status Registers (PSRs)* on page B1-14:~~

- when the CPSR.I bit is set to 1, IRQ interrupts are masked
- when the CPSR.F bit is set to 1, FIQ interrupts are masked.

ARMv7 supports an operating mode where FIQs are not maskable by software. This *Non-maskable Fast Interrupt* (NMFI) operation is controlled by a configuration input signal to the processor, that is asserted HIGH to enable NMFI operation. There is no software control of NMFI operation.

Software can detect whether FIQs are maskable by reading the SCTL.NMFI bit:

NMFI == 0 Software can mask FIQs by setting the CPSR.F bit to 1

NMFI == 1 Software cannot mask FIQs.

For more information see:

- *c1, System Control Register (SCTLR)* on page B3-96 for a VMSA implementation
- *c1, System Control Register (SCTLR)* on page B4-45 for a PMSA implementation.

It is IMPLEMENTATION DEFINED whether an ARMv7 processor supports NMFIs. The SCTLR.NMFI bit is RAO only if the processor supports NMFIs and the configuration input signal is asserted HIGH, otherwise it is RAZ.

When the SCTLR.NMFI bit is 1:

- an instruction writing 0 to the CPSR.F bit clears it to 0, but an instruction attempting to write 1 to it leaves it unchanged.
- CPSR.F can be set to 1 only by exception entries, as described in *CPSR M field and A, I, and F mask bit values on exception entry* on page B1-36.

Use of the A, F, and Mode bits by the Security Extensions

When the Security Extensions are implemented and the processor is in the Non-secure state:

- the CPSR.F bit cannot be changed if the SCR.FW bit is set to 0
- the CPSR.A bit cannot be changed if the SCR.AW bit is set to 0
- the effect of setting CPSR.M to 0b10110, Monitor mode, is UNPREDICTABLE
- the effect of setting CPSR.M to 0b10001, FIQ mode, is UNPREDICTABLE if NSACR.RFR is set to 1.

Note

- When the Security Extensions are implemented and the processor is in the Non-secure state the SPSR.F and SPSR.A bits can be changed even if the corresponding bits in the SCR are set to 0. However, when the SPSR is copied to the CPSR the CPSR.F and CPSR.A bits are not updated if the corresponding bits in the SCR are set to 0.
 - UNPREDICTABLE behavior must not be a security hole. Therefore, every implementation must ensure that:
 - If NSACR.RFR is 0, setting CPSR.M to 0b10110 when in Non-secure state cannot cause entry to either Monitor mode or Secure state
 - If NSACR.RFR is 1, setting CPSR.M to 0b10001 or 0b10110 when in Non-secure state cannot cause entry to Monitor mode, FIQ mode or Secure state.
-

For more information about the access controls provided by the Security Extensions see *c1, Secure Configuration Register (SCR)* on page B3-106.

Software running in Non-secure state might not be able to set the CPSR.F bit to 1 to mask FIQs, as described in *Use of the A, F, and Mode bits by the Security Extensions* on page B1-19. Table B1-2 shows how the SCTL.R.NMFI bit interacts with the SCR.FW bit to control access to the CPSR.F bit, in the Secure and Non-secure security states.

Table B1-2 Summary of NMFI behavior when Security Extensions are implemented

Security state	SCR.FW bit	SCTL.R.NMFI bit	CPSR.F bit properties
Secure	x	0	F bit can be written to 0 or 1
		1	F bit can be written to 0 but not to 1
Non-secure	0	x	F bit cannot be written
	1	0	F bit can be written to 0 or 1
		1	F bit can be written to 0 but not to 1

———— **Note** ————

The SCTL.R.NMFI bit is common to the Secure and Non-secure versions of the SCTL.R, because it is a read-only bit that reflects the value of a configuration input signal.

Pseudocode details of PSR operations

The following pseudocode gives access to the PSRs:

```
bits(32) CPSR, SPSR_fiq, SPSR_irq, SPSR_svc, SPSR_mon, SPSR_abt, SPSR_und;
```

```
// SPSR[] - non-assignment form
// =====
```

```
bits(32) SPSR[]
  if BadMode(CPSR.M) then
    UNPREDICTABLE;
  else
    case CPSR.M of
      when '10001' result = SPSR_fiq; // FIQ mode
      when '10010' result = SPSR_irq; // IRQ mode
      when '10011' result = SPSR_svc; // Supervisor mode
      when '10110' result = SPSR_mon; // Monitor mode
      when '10111' result = SPSR_abt; // Abort mode
      when '11011' result = SPSR_und; // Undefined mode
      otherwise   UNPREDICTABLE;
  return result;
```

```
// SPSR[] - assignment form
// =====
```

```

SPSR[] = bits(32) value
if BadMode(CPSR.M) then
    UNPREDICTABLE;
else
    case CPSR.M of
        when '10001' SPSR_fiq = value; // FIQ mode
        when '10010' SPSR_irq = value; // IRQ mode
        when '10011' SPSR_svc = value; // Supervisor mode
        when '10110' SPSR_mon = value; // Monitor mode
        when '10111' SPSR_abt = value; // Abort mode
        when '11011' SPSR_und = value; // Undefined mode
        otherwise    UNPREDICTABLE;
    return;

// CPSRWriteByInstr()
// =====

CPSRWriteByInstr(bits(32) value, bits(4) bytemask, boolean affect_execstate)

    privileged = CurrentModeIsPrivileged();
    nmfi = (SCTLR.NMFI == '1');

    if bytemask<3> == '1' then
        CPSR<31:27> = value<31:27>; // N,Z,C,V,Q flags
        if affect_execstate then
            CPSR<26:24> = value<26:24>; // IT<1:0>,J execution state bits

    if bytemask<2> == '1' then
        // bits <23:20> are reserved SBZP bits
        CPSR<19:16> = value<19:16>; // GE<3:0> flags

    if bytemask<1> == '1' then
        if affect_execstate then
            CPSR<15:10> = value<15:10>; // IT<7:2> execution state bits
        CPSR<9> = value<9>; // E bit is user-writable
        if privileged && (IsSecure() || SCR.AW == '1') then
            CPSR<8> = value<8>; // A interrupt mask

    if bytemask<0> == '1' then
        if privileged then
            CPSR<7> = value<7>; // I interrupt mask
        if privileged && (IsSecure() || SCR.FW == '1') && (!nmfi || value<6> == '0') then
            CPSR<6> = value<6>; // F interrupt mask
        if affect_execstate then
            CPSR<5> = value<5>; // T execution state bit
        if privileged then
            if BadMode(value<4:0>) then
                UNPREDICTABLE;
            else
                // Check for attempts to enter modes only permitted in Secure state from
                // Non-secure state. These are Monitor mode ('10110'), and FIQ mode ('10001')
                // if the Security Extensions have reserved it. The definition of UNPREDICTABLE
                // does not permit the resulting behavior to be a security hole.
                if !IsSecure() && value<4:0> == '10110' then UNPREDICTABLE;

```

```
        if !IsSecure() && value<4:0> == '10001' && NSACR.RFR == '1' then UNPREDICTABLE;
        CPSR<4:0> = value<4:0>;          // M<4:0> mode bits
    return;

// SPSRWriteByInstr()
// =====

SPSRWriteByInstr(bits(32) value, bits(4) bytemask)

    if CurrentModeIsUserOrSystem() then UNPREDICTABLE;

    if bytemask<3> == '1' then
        SPSR[]<31:24> = value<31:24>; // N,Z,C,V,Q flags, IT<1:0>,J execution state bits

    if bytemask<2> == '1' then
        // bits <23:20> are reserved SBZP bits
        SPSR[]<19:16> = value<19:16>; // GE<3:0> flags

    if bytemask<1> == '1' then
        SPSR[]<15:8> = value<15:8>; // IT<7:2> execution state bits, E bit, A interrupt mask

    if bytemask<0> == '1' then
        SPSR[]<7:5> = value<7:5>; // I,F interrupt masks, T execution state bit
        if BadMode(value<4:0>) then // Mode bits
            UNPREDICTABLE;
        else
            SPSR[]<4:0> = value<4:0>;

    return;
```

B1.4 Instruction set states

The instruction set states are described in Chapter A2 *Application Level Programmers' Model* and application level operations on them are described there. This section supplies more information about how they interact with system level functionality, in the sections:

- *Exceptions and instruction set state.*
- *Unimplemented instruction sets.*

B1.4.1 Exceptions and instruction set state

An exception is handled in the appropriate exception mode. The SCTL_R.TE bit determines the processor instruction set state that handles exceptions. If necessary, the processor changes to this instruction set state on exception entry. For more information see:

- *c1, System Control Register (SCTL_R) on page B3-96 for a VMSA implementation*
- *c1, System Control Register (SCTL_R) on page B4-45 for a PMSA implementation.*

When an exception is taken, the value of the CPSR before the exception is written to the SPSR for the exception mode.

On returning from the exception:

- the CPSR is restored:
 - from a memory location if the RFE instruction is used
 - otherwise, from the SPSR for the exception mode
- the processor instruction set state is determined by the restored CPSR.J and CPSR.T values.

———— **Note** —————

The Reset exception is a special case and behaves differently, see *Reset* on page B1-48.

B1.4.2 Unimplemented instruction sets

The CPSR.J and CPSR.T bits define the current instruction set state, see *ISETSTATE* on page A2-15. The Jazelle state is optional, and the ThumbEE state is optional in the ARMv7-R architecture. Some system instructions permit an attempt to set CPSR.J and CPSR.T to values that select an unimplemented instruction set option, for example to set CPSR.J = 1, CPSR.T = 0 on an processor that does not implement the Jazelle state. If such values are written to CPSR.J and CPSR.T, the implementation behaves in one of these ways:

- Sets CPSR.J and CPSR.T to the requested values and causes the next instruction to be ~~UNDEFINED~~. ~~Entry to the Undefined Instruction handler forces the processor into the state indicated by the SCTL_R.TE bit. The handler can detect the cause of the exception because CPSR.J and CPSR.T are set to the unimplemented combination in SPSR_und. Table B1-4 on page B1-34 shows the value in LR_und on exception entry.~~

~~For the description of the SCTL_R see:~~

- ~~*c1, System Control Register (SCTL_R) on page B3-96 for a VMSA implementation*~~
- ~~*c1, System Control Register (SCTL_R) on page B4-45 for a PMSA implementation*~~

- Does not set CPSR.J and CPSR.T to the requested values. The processor might change the value of one or both of the bits in such a way that the new values correspond to an implemented instruction set state. If this is done then the instruction set state changes to this new state. The detailed behavior of the attempt to change to an unimplemented state is IMPLEMENTATION DEFINED.

B1.5 The Security Extensions

It is IMPLEMENTATION DEFINED whether an ARMv7-A system includes the Security Extensions. When implemented, the Security Extensions integrate hardware security features into the architecture, to facilitate the development of secure applications. Many features of the architecture are extended to integrate with the Security Extensions, and because of this integration of the Security Extensions into the architecture, features of the Security Extensions are described in many sections of this manual.

Note

The Security Extensions are also permitted as an extension to the ARMv6K architecture. The resulting combination is sometimes known as the ARMv6Z or ARMv6KZ architecture.

General information about the Security Extensions is given in:

- *Security states*
- *Impact of the Security Extensions on the modes and exception model* on page B1-28
- *Effect of the Security Extensions on the CP15 registers* on page B3-71.

B1.5.1 Security states

The Security Extensions define two security states, Secure state and Non-secure state. All code execution takes place either in Secure state or in Non-secure state:

- each security state operates in its own virtual memory address space
- many system controls can be set independently in each of the security states
- all of the processor modes that are available in a system that does not implement the Security Extensions are available in each of the security states.

The Security Extensions also define an additional processor mode, Monitor mode, that provides a bridge between code running in Non-secure state and code running in Secure state.

The following features mean the two security states can provide more security than is typically provided by systems using the split between privileged and unprivileged code:

- the memory system provides mechanisms that prevent the Non-secure state accessing regions of the physical memory designated as Secure
- system controls that apply to the Secure state are not accessible from the Non-secure state
- entry to the Secure state from the Non-secure state is provided only by a small number of exceptions
- exit from the Secure state to the Non-secure state is provided only by a small number of mechanisms
- many operating system exceptions can be handled without changing security state.

The fundamental mechanism that determines the security state is the SCR.NS bit, see *c1, Secure Configuration Register (SCR)* on page B3-106:

- for all modes other than Monitor mode, the SCR.NS bit determines the security state for code execution
- code executing in Monitor mode is executed in the Secure state regardless of the value of the SCR.NS bit.

Code can change the SCR only if it is executing in the Secure state.

The general-purpose registers and the processor status registers are not banked between the Secure and the Non-secure states. When execution switches between the Non-secure and Secure security states, ARM expects that the values of these registers are switched by a kernel running mostly in Monitor mode.

Many of the system registers described in *Coprocessors and system control* on page B1-62 are banked between the Secure and Non-secure security states. A banked copy of a register applies only to execution in the appropriate security state. A small number of system registers are not banked but apply to both the Secure and Non-secure security states. Typically the registers that are not banked relate to global system configuration options that ARM expects to be common to the two security states.

Figure B1-2 on page B1-27 shows the normal transfers of control between different modes and security states.

———— **Note** —————

In Figure B1-2 on page B1-27, the route labelled as MCR is for an MCR instruction writing to the SCR, that sets SCR.NS to 1 (Non-secure) at a time when SCR.NS == 0 (Secure) and the processor is not in Monitor mode. This is a possible transfer, but ARM recommends that the value of SCR.NS is changed only by code executing in Monitor mode, see *Changing from Secure to Non-secure state* on page B1-27.

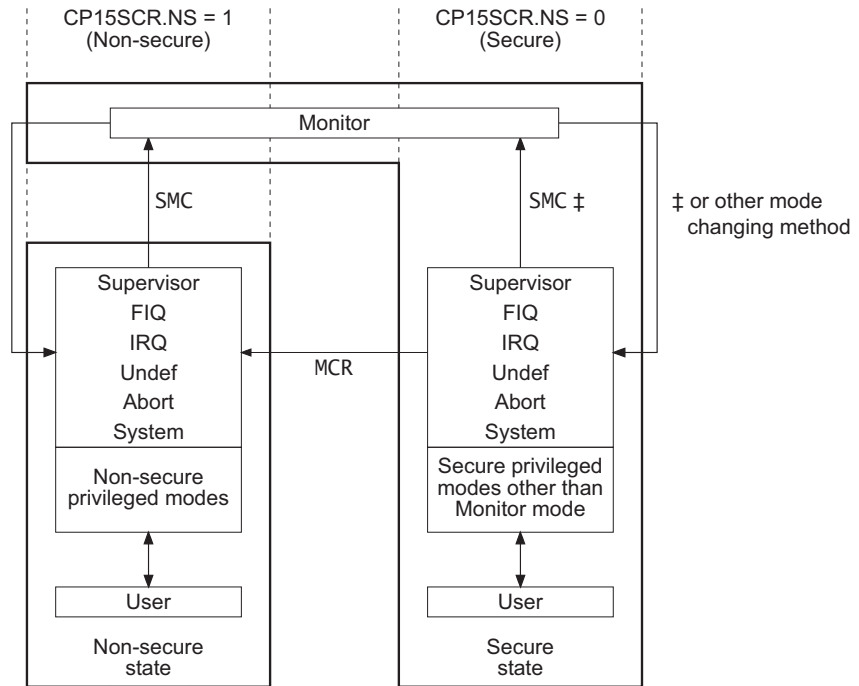

Figure B1-2 Security state, Monitor mode, and the SCR.NS bit

Note

It is important to distinguish between:

Monitor mode This is a processor mode that is only available when the Security Extensions are implemented. It is used in normal operation, as a mechanism to transfer between Secure and Non-secure state, as described in this section.

Monitor debug-mode

This is a debug mode and is available regardless of whether the Security Extensions are implemented. For more information, see *About the ARM Debug architecture* on page C1-3.

Changing from Secure to Non-secure state

The security state is controlled by the SCR.NS bit, and ARM recommends that the SCR is modified only in Monitor mode. Monitor mode is responsible for switching between Secure and Non-secure states.

To return to Non-secure state, set the SCR.NS bit to 1 and then perform an exception return.

Note

To avoid security holes, ARM strongly recommends that:

- you do not change from Secure to Non-secure state by using an MSR or CPS instruction to switch from Monitor mode to some other mode while SCR.NS is 1
 - you do not use an MCR instruction that writes SCR.NS to change from Secure to Non-secure state. This means you should not alter the SCR.NS bit in any mode except Monitor mode.
-

The usual mechanism for changing from Secure to Non-secure state is an exception return.

Pseudocode details of Secure state operations

The `HaveSecurityExt()` function returns `TRUE` if the Security Extensions are implemented, and `FALSE` otherwise.

The following function returns `TRUE` if the Security Extensions are not implemented or the processor is in Secure state, and `FALSE` otherwise.

```
// IsSecure()
// =====

boolean IsSecure()
    return !HaveSecurityExt() || SCR.NS == '0' || CPSR.M == '10110'; // Monitor mode
```

B1.5.2 Impact of the Security Extensions on the modes and exception model

This section summarizes the effect of the Security Extensions on the modes and exception model, to give an overview of the Security Extensions. When the Security Extensions are implemented:

- An additional mode, Monitor mode, is implemented. For more information, see *ARM processor modes* on page B1-6 and *Security states* on page B1-25.
- An additional exception, the *Secure Monitor Call (SMC)* exception, is implemented. This is generated by the *SMC* instruction. For more information, see *Secure Monitor Call (SMC) exception* on page B1-53 and *SMC (previously SMI)* on page B6-18.
- Because the SCTLR is banked between the Secure and Non-secure states, the V and VE bits are defined independently for the Secure and Non-secure states. For each state:
 - the SCTLR.V bit controls whether the normal or the high exception vectors are used
 - the SCTLR.VE bit controls whether the IRQ and FIQ vectors are IMPLEMENTATION DEFINED.

For more information, see *Exception vectors and the exception base address* on page B1-30.

- The base address for the normal exception vectors is held in a CP15 register that is banked between the two security states. This register defines the base address used for exceptions handled in modes other than Monitor mode. Another CP15 register holds the base address for exceptions handled in Monitor mode. For more information, see *Exception vectors and the exception base address* on page B1-30.

- If an exception is taken in Monitor mode in Non-debug state, the SCR.NS bit is set to zero, see *c1, Secure Configuration Register (SCR)* on page B3-106. This forces Secure state entry for all exceptions. However, if an exception is taken in Monitor mode in Debug state, the SCR.NS bit is not set to zero.

———— **Note** —————

Many uses of the Security Extensions can be simplified if the system is designed so that exceptions cannot be taken in Monitor mode.

- Setting bits in the Secure Configuration Register causes one or more of external aborts, IRQs and FIQs to be handled in Monitor mode and to use the Monitor exception base address:
 - setting the SCR.EA bit to 1 means external aborts are handled in Monitor mode, instead of Abort mode
 - setting the SCR.FIQ bit to 1 means FIQs are handled in Monitor mode, instead of FIQ mode
 - setting the SCR.IRQ bit to 1 means IRQs are handled in Monitor mode, instead of IRQ mode.
 For more information see:
 - *Control of exception handling by the Security Extensions* on page B1-41
 - *c1, Secure Configuration Register (SCR)* on page B3-106.
- Setting bits in the Secure Configuration Register prevents code executing in Non-secure state from being able to mask one or both of asynchronous aborts and FIQs:
 - Setting the SCR.AW bit to 1 prevents Non-secure setting of CPSR.A to 1.
 - Setting the SCR.FW bit to 1 prevents Non-secure setting of CPSR.F to 1. For details of how this setting interacts with NMFI see *Non-maskable fast interrupts* on page B1-18.

B1.6 Exceptions

An exception causes the processor to suspend program execution to handle an event, such as an externally generated interrupt or an attempt to execute an undefined instruction. Exceptions can be generated by internal and external sources.

Normally, when an exception is taken the processor state is preserved immediately, before handling the exception. This means that, when the event has been handled, the original state can be restored and program execution resumed from the point where the exception was taken.

More than one exception might be generated at the same time, and a new exception can be generated while the processor is handling an exception.

The following sections describe exception handling in general:

- *Exception vectors and the exception base address*
- *Exception priority order* on page B1-33
- *Exception entry* on page B1-34
- *Exception return* on page B1-38
- *Exception-handling instructions* on page B1-41
- *Control of exception handling by the Security Extensions* on page B1-41
- *Low interrupt latency configuration* on page B1-43.
- *Wait For Event and Send Event* on page B1-44
- *Wait For Interrupt* on page B1-47.

The following sections give details of each exception:

- *Reset* on page B1-48
- *Undefined Instruction exception* on page B1-49
- *Supervisor Call (SVC) exception* on page B1-52
- *Secure Monitor Call (SMC) exception* on page B1-53
- *Prefetch Abort exception* on page B1-54
- *Data Abort exception* on page B1-55
- *IRQ exception* on page B1-58
- *FIQ exception* on page B1-60.

B1.6.1 Exception vectors and the exception base address

When an exception is taken, processor execution is forced to an address that corresponds to the type of exception. These addresses are called the *exception vectors*.

By default, the exception vectors are eight consecutive word-aligned memory addresses, starting at an *exception base address*. Table B1-3 on page B1-31 shows the assignment of the exceptions to the eight memory addresses.

Table B1-3 Offsets from exception base addresses

Exception offset	Exception that is vectored at that offset from:	
	Monitor exception base address ^a	Base address for all other exceptions
0x00	Not used	Reset
0x04	Not used	Undefined Instruction
0x08	Secure Monitor Call (SMC)	Supervisor Call (SVC)
0x0C	Prefetch Abort	Prefetch Abort
0x10	Data Abort	Data Abort
0x14	Not used	Not used
0x18	IRQ (interrupt)	IRQ (interrupt)
0x1C	FIQ (fast interrupt)	FIQ (fast interrupt)

a. This column applies only if the Security Extensions are implemented.

The default exception vectors for the IRQ and FIQ exceptions can be changed by setting the SCTL.R.VE bit to 1, as described in *Vectored interrupt support* on page B1-32.

If the Security Extensions are not implemented there is a single exception base address. This is controlled by the SCTL.R.V bit:

V == 0 Exception base address = 0x00000000. This setting is referred to as normal vectors, or as low vectors.

V == 1 Exception base address = 0xFFFF0000. This setting is referred to as high vectors, or *Hivecs*.

———— **Note** —————

Use of the Hivecs setting, V == 1, is deprecated in ARMv7-R. ARM recommends that Hivecs is used only in ARMv7-A implementations.

If the Security Extensions are implemented there are three exception base addresses:

- the Non-secure exception base address is used for all exceptions that are processed in Non-secure state
- the Secure exception base address is used for all exceptions that are processed in Secure state but not in Monitor mode
- the Monitor exception base address is used for all exceptions that are processed in Monitor mode.

See *CPSR M field and A, I, and F mask bit values on exception entry* on page B1-36 to determine the mode in which an exception is processed. If that mode is Monitor mode then the exception is processed in Secure state, otherwise the exception is processed in the current security state, determined at the time when the exception is taken.

The Non-secure exception base address is controlled by the SCTL.R.V bit in the Non-secure SCTL.R:

V == 0 The exception base address is the value of the Non-secure *Vector Base Address Register (VBAR)*, see *c12, Vector Base Address Register (VBAR)* on page B3-148.

V == 1 Exception base address = 0xFFFF0000. This setting is often referred to as *Hivecs*.

The Secure exception base address is controlled similarly, by the Secure SCTL.R.V bit and the Secure VBAR.

The Monitor exception base address is always the value of the *Monitor Vector Base Address Register (MVBAR)*, see *c12, Monitor Vector Base Address Register (MVBAR)* on page B3-149.

Vectored interrupt support

By default, the IRQ and FIQ exception vectors are at fixed offsets from the exception base address that is being used. This is consistent with previous versions of the ARM architecture. With this default configuration, each of the FIQ and IRQ handlers typically starts with an instruction sequence that determines the cause of the interrupt and then branches to an appropriate routine to handle it.

Support for vectored interrupts means an interrupt controller can prioritize interrupts and provide the address of the required interrupt handler directly to the processor, for use as the interrupt vector. Vectored interrupt behavior is enabled by setting the SCTL.R.VE bit to 1, see:

- *c1, System Control Register (SCTL.R)* on page B3-96 for a VMSA implementation
- *c1, System Control Register (SCTL.R)* on page B4-45 for a PMSA implementation.

The hardware that supports vectored interrupts is IMPLEMENTATION DEFINED.

For backwards compatibility, the vectored interrupt mechanism is disabled on reset.

When the Security Extensions are implemented:

- The SCTL.R.VE bit is banked between Secure and Non-secure states to provide independent control of whether vectored interrupt support is enabled.
- Interrupts can be trapped to Monitor mode, by setting either or both of the SCR.IRQ and SCR.FIQ bits to 1. When an interrupt is trapped to Monitor mode it uses the vector in the vector table addressed by the Monitor exception base address held in MVBAR, regardless of the value of either banked copy of the SCTL.R.VE bit.

Operation

In pseudocode, the current exception base address for exceptions processed in Monitor mode is determined by reading MVBAR, and for other exceptions by the following function:

```
// ExcVectorBase()
// =====

bits(32) ExcVectorBase()
    if SCTRL.V == '1' then // Hivecs selected, base = 0xFFFF0000
        return Ones(16):Zeros(16);
    elsif HaveSecurityExt() then
        return VBAR;
    else
        return Zeros(32);
```

B1.6.2 Exception priority order

In principle a number of different synchronous exceptions can be generated by a single instruction. The following principles determine which synchronous exception is taken:

- No instruction is valid if it has a synchronous Prefetch Abort exception associated with it. Therefore, other synchronous exceptions are not taken in this case.
- An instruction that generates an Undefined Instruction exception cannot cause any memory access, and therefore cannot cause a Data Abort exception.
- All other synchronous exceptions are mutually exclusive and are derived from a decode of the instruction.

The ARM architecture does not define when asynchronous exceptions are taken. Therefore the prioritization of asynchronous exceptions relative to other exceptions, both synchronous and asynchronous, depends on the implementation.

The CPSR includes a mask bit for each type of asynchronous exception. Setting one of these bits to 1 prevents the corresponding asynchronous exception from being taken. Taking an exception sets an exception-dependent subset of these mask bits.

Note

- The subset of the CPSR mask bits that is set on taking an exception prioritizes the execution of FIQ handlers over that of IRQ and asynchronous abort handlers.
 - A special requirement applies to asynchronous watchpoints - see *Debug event prioritization* on page C3-43.
-

B1.6.3 Exception entry

On taking an exception:

1. The value of the CPSR is saved in the SPSR for the exception mode that is handling the exception.
2. The value of (PC + exception-dependent offset) is saved in the LR for the exception mode that is handling the exception, see Table B1-4.
3. The CPSR and PC are updated with information for the exception handler:
 - The CPSR is updated with new context information. This includes:
 - Setting CPSR.M to the processor mode in which the exception is to be handled.
 - Disabling appropriate classes of interrupt, to prevent uncontrolled nesting of exception handlers. For more information, see Table B1-6 on page B1-36, Table B1-7 on page B1-37, and Table B1-8 on page B1-37.
 - Setting the instruction set state to the instruction set chosen for exception entry, see *Instruction set state on exception entry* on page B1-35.
 - Setting the endianness to the value chosen for exception entry, see *CPSR.E bit value on exception entry* on page B1-38.
 - Clearing the IT[7:0] bits to 0.

For more information, see *CPSR M field and A, I, and F mask bit values on exception entry* on page B1-36.
 - The appropriate exception vector is loaded to the PC, see *Exception vectors and the exception base address* on page B1-30.
4. Execution continues from the address held in the PC.

At step 2 of the exception entry, the address saved in the LR depends on:

- the Exception type
- the instruction set state in which the processor is executing when the exception occurs.

Table B1-4 shows the LR value saved for all cases:

Table B1-4 Link Register value saved on exception entry

Exception	Base LR value ^a	Offset, for processor state of: ^a		
		ARM	Thumb or ThumbEE	Jazelle
Reset	UNKNOWN	-	-	-
Undefined Instruction	Address of the undefined instruction	+ 4	+2	+2 or +4 ^b
SVC	Address of SVC instruction	+ 4	+2	- ^c
SMC	Address of SMC instruction	+ 4	+4	- ^c

Table B1-4 Link Register value saved on exception entry (continued)

Exception	Base LR value ^a	Offset, for processor state of: ^a		
		ARM	Thumb or ThumbEE	Jazelle
Prefetch Abort	Address of aborted instruction fetch	+ 4	+4	+ 4
Data Abort	Address of instruction that generated the abort	+ 8	+8	+ 8
IRQ or FIQ	Address of next instruction to execute	+ 4	+4	+ 4

- Except for the Reset exception, the value saved in the LR is the base LR value plus the offset value for the processor state immediately before the exception entry.
- ~~In Jazelle state, Undefined Instruction exceptions can only happen on a processor that includes a trivial implementation of Jazelle state. On such a processor, if an exception return instruction writes {CPSR.J, CPSR.T} to 0b10, the processor takes an Undefined Instruction exception when it next attempts to execute an instruction. It is IMPLEMENTATION DEFINED whether the processor uses an offset of +2 or +4 in these circumstances, but it must always use the same offset.~~
- SVC and SMC exceptions cannot occur in Jazelle state.

Instruction set state on exception entry

Exception handlers always execute in either Thumb state or ARM state. Which state they execute in is determined by the Thumb Exception enable bit, SCTLR.TE, see:

- *c1, System Control Register (SCTLR)* on page B3-96 for a VMSA implementation
- *c1, System Control Register (SCTLR)* on page B4-45 for a PMSA implementation.

On exception entry, the CPSR.T and CPSR.J bits are set to values that depend on the SCTLR.TE value, as shown in Table B1-5:

Table B1-5 CPSR.J and CPSR.T bit values on exception entry

SCTLR.TE	CPSR.J	CPSR.T	Exception handler state
0	0	0	ARM
1	0	1	Thumb

When the Security Extensions are implemented, the SCTLR is banked for Secure and Non-secure states, and therefore the TE bit value might be different for Secure and Non-secure states. The SCTLR.TE bit for the security state in which the exception is handled determines the instruction set state for the exception handler. This means the exception handlers might run in different instruction set states, depending on the security state.

CPSR M field and A, I, and F mask bit values on exception entry

On exception entry, the processor mode is set to one of the exception modes and the CPSR[A,I,F] interrupt disable (mask) bits are set to new values:

- the CPSR.I bit is always set to 1, to disable IRQs
- the CPSR.M (mode), CPSR.A (asynchronous abort disable), and CPSR.F (FIQ disable) bits are set to values that depend:
 - on the exception type
 - if the Security Extensions are implemented, on the security state and some bits of the SCR, see *c1, Secure Configuration Register (SCR)* on page B3-106.

The new values are shown in:

- Table B1-6, for an implementation that does not include the Security Extensions
- Table B1-7 on page B1-37, for an implementation that includes the Security Extensions, when the security state is Secure (NS == 0).
- Table B1-8 on page B1-37, for an implementation that includes the Security Extensions, when the security state is Non-secure (NS == 1).

In these tables, Unchanged indicates that the bit value is unchanged from its value when the exception was taken.

Table B1-6 A and F bit values on exception entry, without Security Extensions

Exception	Exception mode	CPSR.A	CPSR.F
Reset	Supervisor	1	1
Undefined Instruction	Undefined	Unchanged	Unchanged
Supervisor Call (SVC)	Supervisor	Unchanged	Unchanged
All aborts	Abort	1	Unchanged
IRQ	IRQ	1	Unchanged
FIQ	FIQ	1	1

Table B1-7 A and F bit values on exception entry, with Security Extensions and NS == 0

Exception	SCR bits			Exception mode	NS == 0, Secure	
	EA	IRQ	FIQ		CPSR.A	CPSR.F
Reset	x	x	x	Supervisor	1	1
Undefined Instruction	x	x	x	Undefined	Unchanged	Unchanged
Supervisor Call (SVC)	x	x	x	Supervisor	Unchanged	Unchanged
Secure Monitor Call (SMC)	x	x	x	Monitor	1	1
All external aborts	0	x	x	Abort	1	Unchanged
	1	x	x	Monitor	1	1
All internal aborts	x	x	x	Abort	1	Unchanged
IRQ	x	0	x	IRQ	1	Unchanged
	x	1	x	Monitor	1	1
FIQ	x	x	0	FIQ	1	1
	x	x	1	Monitor	1	1

Table B1-8 A and F bit values on exception entry, with Security Extensions and NS == 1

Exception	SCR bits					Exception mode	NS == 1, Non-secure	
	EA	IRQ	FIQ	AW	FW		CPSR.A	CPSR.F
Reset	x	x	x	x	x	Supervisor	1	1
Undefined Instruction	x	x	x	x	x	Undefined	Unchanged	Unchanged
Supervisor Call (SVC)	x	x	x	x	x	Supervisor	Unchanged	Unchanged
Secure Monitor Call (SMC)	x	x	x	x	x	Monitor	1	1
All external aborts	0	x	x	0	x	Abort	Unchanged	Unchanged
	0	x	x	1	x	Abort	1	Unchanged
	1	x	x	x	x	Monitor	1	1

Table B1-8 A and F bit values on exception entry, with Security Extensions and NS == 1 (continued)

Exception	SCR bits					Exception mode	NS == 1, Non-secure	
	EA	IRQ	FIQ	AW	FW		CPSR.A	CPSR.F
All internal aborts	x	x	x	0	x	Abort	Unchanged	Unchanged
	x	x	x	1	x	Abort	1	Unchanged
IRQ	x	0	x	0	x	IRQ	Unchanged	Unchanged
	x	0	x	1	x	IRQ	1	Unchanged
	x	1	x	x	x	Monitor	1	1
FIQ	x	x	0	0	0	FIQ	Unchanged	Unchanged
	x	x	0	0	1	FIQ	Unchanged	1
	x	x	0	1	0	FIQ	1	Unchanged
	x	x	0	1	1	FIQ	1	1
	x	x	1	x	x	Monitor	1	1

CPSR.E bit value on exception entry

On exception entry, the CPSR.E bit is set to the value of the SCTLR.EE bit. This bit of the CPSR controls the load and store endianness for data handling by the exception handler, see the bit description in *Format of the CPSR and SPSRs* on page B1-16. For the description of the SCTLR see:

- *c1*, System Control Register (SCTLR) on page B3-96 for a VMSA implementation
- *c1*, System Control Register (SCTLR) on page B4-45 for a PMSA implementation.

B1.6.4 Exception return

In the ARM architecture, *exception return* requires the simultaneous restoration of the PC and CPSR to values that are consistent with the desired state of execution on returning from the exception. Normally, this is the state of execution just before the exception was taken, but it can be different in some circumstances, for example if the exception handler performed instruction emulation.

Typically, this involves returning to one of:

- the instruction boundary at which an asynchronous exception was taken
- the instruction following an SVC or SMC instruction, for an exception generated by one of those instructions
- the instruction that caused the exception, after the reason for the exception has been removed

- the subsequent instruction, if the instruction that caused the exception has been emulated in the exception handler.

The ARM architecture makes no requirement that exception return must be to any particular place in the execution stream. However, the architecture does have a *preferred exception return* for each exception other than Reset. The values of the SPSR.IT[7:0] bits generated on exception entry are always correct for the preferred exception return, but might require adjustment by software if returning elsewhere.

In some cases, the value of the LR set on taking the exception, as shown in Table B1-4 on page B1-34, makes it necessary to perform a subtraction to calculate the appropriate return address. The value that must be subtracted for the preferred exception return, and other details of the preferred exception return, are given in the description of each of the exceptions.

The ARM architecture provides the following *exception return instructions*:

- Data-processing instructions with the S bit set and the PC as a destination, see *SUBS PC, LR and related instructions* on page B6-25.
Typically, SUBS is used when a subtraction is required, and SUBS with an operand of 0 or MOVS is used otherwise.
- From ARMv6, the RFE instruction, see *RFE* on page B6-16. If a subtraction is required, typically it is performed before saving the LR value to memory.
- In ARM state, a form of the LDM instruction, see *LDM (exception return)* on page B6-5. If a subtraction is required, typically it is performed before saving the LR value to memory.

Alignment of exception returns

An unaligned exception return is one where the address transferred to the PC on an exception return is not aligned to the size of instructions in the target instruction set. The target instruction set is controlled by the [J,T] bits of the value transferred to the CPSR for the exception return. The behavior of the hardware for exception returns for different values of the [J,T] bits is as follows:

- [J,T] == 00** The target instruction set state is ARM state. Bits [1:0] of the address transferred to the PC are ignored by the hardware.
- [J,T] == 01** The target instruction set state is Thumb state:
- bit [0] of the address transferred to the PC is ignored by the hardware
 - bit [1] of the address transferred to the PC is part of the instruction address.
- [J,T] == 10** The target instruction set state is Jazelle state. In a non-trivial implementation of the Jazelle extension, bits [1:0] of the address transferred to the PC are part of the instruction address. In a trivial implementation of the Jazelle extension, behavior is UNPREDICTABLE, see *Exception return to an unsupported instruction set state* on page B1-40. For details of the trivial implementation of [Jazelle state](#) see *Trivial implementation of the Jazelle extension* on page B1-81.



- [J,T] == 11** The target instruction set state is ThumbEE state:
- bit [0] of the address transferred to the PC is ignored by the hardware
 - bit [1] of the address transferred to the PC is part of the instruction address.

ARM deprecates any dependence on the requirements that the hardware ignores bits of the address. ARM recommends that the address transferred to the PC for an exception return is correctly aligned for the target instruction set.

After an exception entry other than Reset, the LR value has the correct alignment for the instruction set indicated by the SPSR.[J,T] bits. This means that if exception return instructions are used with the LR and SPSR values produced by such an exception entry, the only precaution software needs to take to ensure correct alignment is that any subtraction is of a multiple of four if returning to ARM state, or a multiple of two if returning to Thumb state or to ThumbEE state.

Exception return to an unsupported instruction set state

An implementation that does not support one or both of Jazelle and ThumbEE states does not normally get into an unsupported instruction set state, because:

- on a trivial Jazelle implementation, the BXJ instruction acts as a BX instruction
- on an implementation that does not include ThumbEE support, the ENTERX instruction is UNDEFINED
- normal exception entry and return preserves the instruction set state.

However, it is possible for an exception return instruction to set CPSR.J and CPSR.T to the values corresponding to an unsupported instruction set state. This is most likely to happen because a faulty exception handler restores the wrong value to the CPSR.

If the processor attempts to execute an instruction while the CPSR.J and CPSR.T bits indicate an unsupported instruction set state:

- If the unsupported instruction set state is Jazelle state, behavior is UNPREDICTABLE.
- If the unsupported instruction set state is ThumbEE state, the processor takes an Undefined Instruction exception.

The Undefined Instruction handler can detect the cause of this exception because on entry to the handler the SPSR.J and SPSR.T bits indicate the ThumbEE state. If the Undefined Instruction handler wants to return, avoiding a return to ThumbEE state, it can change the values its exception return instruction writes to the CPSR.J and CPSR.T bits.

If an exception return writes CPSR.J = 1 and CPSR.T = 1, corresponding to ThumbEE state, and also writes the address of an aborting memory location to the PC, it is IMPLEMENTATION DEFINED whether:

- the instruction is fetched and a Prefetch Abort exception is taken because the memory access aborts
- an Undefined Instruction exception is taken, without the instruction being fetched.

An implementation that supports neither of the Jazelle and ThumbEE states can implement the J bits of the PSRs as RAZ/WI. On such an implementation, a return to an unsupported instruction set state cannot occur.

B1.6.5 Exception-handling instructions

From ARMv6, the instruction sets include the following exception-handling instructions, in addition to the exception return instructions described in *Exception return* on page B1-38:

- a CPS (Change Processor State) instruction to simplify changes of processor mode and the disabling and enabling of interrupts, see *CPS* on page B6-3
- an SRS (Store Return State) instruction, to reduce the processing cost of handling exceptions in a different mode to the exception entry mode, by removing any need to use the stack of the original mode, see *SRS* on page B6-20.

As an example of where these instructions might be used, an IRQ routine might want to execute in System or Supervisor mode, so that it can both re-enable IRQs and use BL instructions. This is not possible in IRQ mode, because a nested IRQ could corrupt the return link of a BL at any time.

With the CPS and SRS instructions, the system can use the following instruction sequence at the start of its exception handler:

```

SUB   LR,LR,#4      ; IRQ requires subtraction from LR
SRSFD SP!, #<mode> ; <mode> = 19 for Supervisor, 31 for System
CPSIE i,#<mode>

```

This:

- stores the return state held in the LR and SPSR_irq to the stack for Supervisor mode or for User and System mode
- switches to Supervisor or System mode and re-enables IRQs.

This is done efficiently, without making any use of SP_irq or the IRQ stack.

At the end of the exception handler, an RFEFD SP! instruction pops the return state off the stack and returns from the exception.

B1.6.6 Control of exception handling by the Security Extensions

The Security Exceptions provide additional controls of the handling of:

- aborts, see *Control of aborts by the Security Extensions*
- FIQs, see *Control of FIQs by the Security Extensions* on page B1-42
- IRQs, see *Control of IRQs by the Security Extensions* on page B1-43.

Control of aborts by the Security Extensions

The CPSR.A bit can be used to disable asynchronous aborts. When the Security Extensions are implemented:

- the SCR.AW bit controls whether the CPSR.A bit can be modified in Non-secure state
- the SCR.EA bit controls whether external aborts are handled in Abort mode or Monitor mode.

For details of these bits see *c1, Secure Configuration Register (SCR)* on page B3-106.

Table B1-9 shows the possible values for the SCR.AW and SCR.EA bits, and the abort handling that results in each case:

Table B1-9 Effect of the SCR.AW and SCR.EA bits on abort handling

SCR bits		Effect on abort handling
AW	EA	
0	0	All aborts are handled locally using Abort mode. Asynchronous aborts are maskable only in Secure state. This is the reset state and supports legacy systems.
0	1	All external aborts, synchronous and asynchronous, are handled in Monitor mode. Asynchronous aborts are maskable only in Secure state. All security aborts from peripherals can be treated in a safe manner in Monitor mode.
1	0	All aborts are handled locally, using Abort mode. Asynchronous aborts are maskable in both Secure and Non-secure states.
1	1	All external aborts are trapped to Monitor mode. Non-secure state can hide asynchronous external aborts from the Monitor, by changing the CPSR.A bit.

When the SCR.EA bit is set to 1, and an external abort causes entry to Monitor mode, fault information is written to the Secure copies of the Fault Status and Fault Address registers.

Control of FIQs by the Security Extensions

The CPSR.F bit can be used to disable FIQs. When the Security Extensions are implemented:

- the SCR.FW bit controls whether the CPSR.F bit can be modified in Non-secure state
- the SCR.FIQ bit controls whether FIQs are handled in FIQ mode or Monitor mode.

For details of these bits see *c1, Secure Configuration Register (SCR)* on page B3-106.

Table B1-10 on page B1-43 shows the effect of these bits on FIQ handling:

Table B1-10 Effect of the SCR.AW and SCR.EA bits on FIQ handling

SCR bits		Effect on FIQ handling
FW	FIQ	
0	0	FIQs are handled locally using FIQ mode. FIQs are maskable only in Secure state. This is the reset state and supports legacy systems.
0	1	FIQs are handled in Monitor mode. FIQs are maskable only in Secure state. This setting gives Secure FIQs.
1	0	FIQs are handled locally in FIQ mode. FIQs can be masked, in both Secure and Non-secure states.
1	1	All FIQs are trapped to Monitor mode. Non-secure state can hide FIQs from the Monitor, by changing the CPSR.F bit.

Note

- The configuration with SCR.FW == 1 and SCR.FIQ == 1 permits Non-secure state to deny service by changing the CPSR.F bit. ARM recommends that this configuration is not used.
- Interrupts driven by Secure peripherals are called Secure interrupts. When SCR.FW = 0 and SCR.FIQ = 1, FIQ exceptions can be used as Secure interrupts. These enter Secure state in a deterministic way.

Control of IRQs by the Security Extensions

When the Security Extensions are implemented, the SCR.IRQ bit controls whether IRQs are handled in IRQ mode or Monitor mode. For details of this bit see *c1, Secure Configuration Register (SCR)* on page B3-106.

B1.6.7 Low interrupt latency configuration

The SCTL.R.FI bit is set to 1 to enable the low interrupt latency configuration of an implementation. This configuration can reduce the interrupt latency of the processor. The mechanisms implemented to achieve low interrupt latency are IMPLEMENTATION DEFINED. For the description of the SCTL.R see:

- *c1, System Control Register (SCTL.R)* on page B3-96 for a VMSA implementation
- *c1, System Control Register (SCTL.R)* on page B4-45 for a PMSA implementation.

To ensure that a change between normal and low interrupt latency configurations is synchronized correctly, the SCTL.R.FI bit must be changed only in IMPLEMENTATION DEFINED circumstances. The FI bit can be changed shortly after reset and before enabling the MMU, MPU, or caches, when interrupts are disabled, using the following sequence:

```
DSB
ISB
MCR p15, 0, Rx, c1, c0, c0    ; change FI bit in the SCTLR
DSB
ISB
```

Implementation can define other sequences and circumstances that permit the SCTLR.FI bit to be changed.

When interrupt latency is reduced, this can result in reduced performance overall. Examples of methods that might be used to reduce interrupt latency are:

- disabling Hit-Under-Miss functionality in a processor
- the abandoning of restartable external accesses.

These choices permit the processor to react to a pending interrupt faster than would otherwise be the case.

A low interrupt latency configuration permits interrupts and asynchronous aborts to be taken during a sequence of memory transactions generated by a load/store instruction. For details of what these sequences are and the consequences of taking interrupts and asynchronous aborts in this way see *Single-copy atomicity* on page A3-27.

ARM deprecates any software reliance on the behavior that an interrupt or asynchronous abort cannot occur in a sequence of memory transactions generated by a single load/store instruction to Normal memory.

———— **Note** ————

A particular case that has shown this reliance is load multiples that load the stack pointer from memory. In an implementation where an interrupt is taken during the LDM, this can result in corruption of the stack pointer.

B1.6.8 Wait For Event and Send Event

A multiprocessor operating system requires locking mechanisms to protect data structures from being accessed simultaneously by multiple processors. These mechanisms prevent the data structures becoming inconsistent or corrupted if different processors try to make conflicting changes. If a lock is busy, because a data structure is being used by one processor, it might not be practical for another processor to do anything except wait for the lock to be released. For example, if a processor is handling an interrupt from a device it might need to add data received from the device to a queue. If another processor is removing data from the queue, it will have locked the memory area that holds the queue. The first processor cannot add the new data until the queue is in a consistent state and the lock has been released. It cannot return from the interrupt handler until the data has been added to the queue, so it must wait.

Typically, a spin-lock mechanism is provided for these circumstances:

- A processor requiring access to the protected data attempts to obtain the lock using single-copy atomic synchronization primitives such as the ARM Load-Exclusive and Store-Exclusive operations described in *Synchronization and semaphores* on page A3-12.
- If the processor obtains the lock it performs its memory operation and releases the lock.

- If the processor cannot obtain the lock, it reads the lock value repeatedly in a tight loop until the lock becomes available. At this point it again attempts to obtain the lock.

However, this spin-lock mechanism is not ideal for all situations:

- in a low-power system the tight read loop is undesirable because it uses energy to no effect
- in a multi-threaded processor the execution of spin-locks by waiting threads can significantly degrade overall performance.

Therefore, ARMv7 provides an alternative locking mechanism based on events. The Wait For Event lock mechanism permits a processor that has failed to obtain a lock to enter a low-power state. When the processor that currently holds the required lock releases the lock it sends an event that causes any waiting processors to wake up and attempt to gain the lock again.

———— Note —————

Although a complex operating system can contain thousands of distinct locks, the event sent by this mechanism does not indicate which lock has been released. If the event relates to a different lock, or if another processor acquires the lock more quickly, the processor fails to acquire the lock and can re-enter the low-power state waiting for the next event.

The Wait For Event system relies on hardware and software working together to achieve energy saving:

- the hardware provides the mechanism to enter the Wait For Event low-power state
- the operating system software is responsible for issuing:
 - a Wait For Event instruction when waiting for a spin-lock, to enter the low-power state
 - a Send Event instructions when releasing a spin-lock.

The mechanism depends on the interaction of:

- WFE wake-up events, see *WFE wake-up events*
- the Event Register, see *The Event Register* on page B1-46
- the Send Event instruction, see *The Send Event instruction* on page B1-46
- the Wait For Event instruction, see *The Wait For Event instruction* on page B1-46.

WFE wake-up events

The following events are *WFE wake-up events*:

- the execution of an SEV instruction on any processor in the multiprocessor system
- an IRQ interrupt, unless masked by the CPSR.I bit
- an FIQ interrupt, unless masked by the CPSR.F bit
- an asynchronous abort, unless masked by the CPSR.A bit
- a debug event, if invasive debug is enabled and the debug event is permitted.

For details of the masking bits in the CPSR see *Format of the CPSR and SPSRs* on page B1-16. This masking is an important consideration with this mechanism, because lock mechanisms can be required when interrupts are disabled.

The Event Register

The Event Register is a single bit register for each processor. When set, an event register indicates that an event has occurred, since the register was last cleared, that might prevent the processor needing to suspend operation on issuing a WFE instruction.

The value of the Event Register at reset is UNKNOWN.

The Event Register is set by any WFE wake-up event or by the execution of an exception return instruction. For the definition of exception return instructions see *Exception return* on page B1-38.

The Event Register is cleared only by a Wait For Event instruction.

You cannot read or write the value of the Event Register directly.

The Send Event instruction

The Send Event instruction causes an event to be signaled to all processors in the multiprocessor system. The mechanism used to signal the event to the processors is IMPLEMENTATION DEFINED. The Send Event instruction sets the Event Register.

The Send Event instruction, SEV, is available to both unprivileged and privileged code, see *SEV* on page A8-316.

The Wait For Event instruction

The action of the Wait For Event instruction depends on the state of the Event Register:

- If the Event Register is set, the instruction clears the register and returns immediately. Normally, if this happens the processor makes another attempt to claim the lock.
- If the Event Register is clear the processor can suspend execution and enter a low-power state. It can remain in that state until the processor detects a WFE wake-up event or a reset. When the processor detects a WFE wake-up event, or earlier if the implementation chooses, the WFE instruction completes.

The Wait For Event instruction, WFE, is available to both unprivileged and privileged code, see *WFE* on page A8-808.

The code using the Wait For Event mechanism must be tolerant to spurious wake-up events, including multiple wake ups.

Pseudocode details of the Wait For Event lock mechanism

The `ClearEventRegister()` pseudocode procedure clears the Event Register of the current processor.

The `EventRegistered()` pseudocode function returns TRUE if the Event Register of the current processor is set and FALSE if it is clear:

```
boolean EventRegistered()
```

The `WaitForEvent()` pseudocode procedure optionally suspends execution until a WFE wake-up event or reset occurs, or until some earlier time if the implementation chooses. It is IMPLEMENTATION DEFINED whether restarting execution after the period of suspension causes a `ClearEventRegister()` to occur.

The `SendEvent()` pseudocode procedure sets the Event Register of every processor in the multiprocessor system.

B1.6.9 Wait For Interrupt

Previous versions of the ARM architecture have included a Wait For Interrupt concept, and Wait For Interrupt is a required feature of the architecture from ARMv6. In ARMv7, Wait For Interrupt is supported only through an instruction, WFI, that is provided in the ARM and Thumb instruction sets. For more information, see *WFI* on page A8-810.

Note

In ARMv7 the CP15 c7 encoding previously used for WFI is redefined as a NOP, see *CP15 c7, No Operation (NOP)* on page B3-138 and *CP15 c7, Miscellaneous functions* on page B4-72.

When a processor issues a WFI instruction it can suspend execution and enter a low-power state. It can remain in that state until the processor detects a reset or one of the following *WFI wake-up events*:

- an IRQ interrupt, regardless of the value of the CPSR.I bit
- an FIQ interrupt, regardless of the value of the CPSR.F bit
- an asynchronous abort, regardless of the value of the CPSR.A bit
- a debug event, when invasive debug is enabled and the debug event is permitted.

When the hardware detects a WFI wake-up event, or earlier if the implementation chooses, the WFI instruction completes.

WFI wake-up events cannot be masked by the mask bits in the CPSR.

Note

- Because debug entry is one of the WFI wake-up events, ARM strongly recommends that Wait For Interrupt is used as part of an idle loop rather than waiting for a single specific interrupt event to occur and then moving forward. This ensures the intervention of debug while waiting does not significantly change the function of the program being debugged.
 - In some previous implementations of Wait For Interrupt, the idle loop is followed by exit functions that must be executed before the interrupt is taken. The operation of Wait For Interrupt remains consistent with this model, and therefore differs from the operation of Wait For Event.
 - Some implementations of Wait For Interrupt drain down any pending memory activity before suspending execution. This increases the power saving, by increasing the area over which clocks can be stopped. This operation is not required by the ARM architecture, and code must not rely on Wait For Interrupt operating in this way.
-

Using WFI to indicate an idle state on bus interfaces

A common implementation practice is to complete any entry into power-down routines with a WFI instruction. Typically, the WFI instruction:

1. forces the suspension of execution, and of all associated bus activity
2. ceases to execute instructions from processor.

The control logic required to do this typically tracks the activity of the bus interfaces of the processor. This means it can signal to an external power controller that there is no ongoing bus activity.

The exact nature of this interface is IMPLEMENTATION DEFINED, but the use of Wait For Interrupt as the only architecturally-defined mechanism that completely suspends execution makes it very suitable as the preferred power-down entry mechanism for future implementations.

Pseudocode details of Wait For Interrupt

The `WaitForInterrupt()` pseudocode procedure optionally suspends execution until a WFI wake-up event or reset occurs, or until some earlier time if the implementation chooses.

B1.6.10 Reset

On an ARM processor, when the Reset input is asserted the processor immediately stops execution of the current instruction. When Reset is de-asserted, the actions described in *Exception entry* on page B1-34 are performed, for the Reset exception. The processor then starts executing code, in Supervisor mode with interrupts disabled. Execution starts from the normal or high reset vector address, `0x00000000` or `0xFFFF0000`, as determined by the reset value of the `SCTLR.V` bit. This reset value can be determined by an IMPLEMENTATION DEFINED configuration input signal.

————— Note —————

- The ARM architecture does not distinguish between multiple levels of reset. A system can provide multiple distinct levels of reset that reset different parts of the system. These all correspond to this single reset exception.
- The reset value of the `SCTLR.EE` bit can be defined by a configuration input signal. If this is done, that value also applies to the `CPSR.E` bit on reset. For more information see:
 - *c1, System Control Register (SCTLR)* on page B3-96 for a VMSA implementation
 - *c1, System Control Register (SCTLR)* on page B4-45 for a PMSA implementation.

The following pseudocode describes how this exception is taken:

```
// TakeReset()
// =====

TakeReset()
  // Enter Supervisor mode and (if relevant) Secure state, and reset CP15. This affects
  // the banked versions and values of various registers accessed later in the code.
  // Also reset other system components.
  CPSR.M = '10011'; // Supervisor mode
```

```

if HaveSecurityExt() then SCR.NS = '0';
ResetCP15Registers();
ResetDebugRegisters();
if HaveAdvSIMDorVFP() then FPEXC.EN = '0'; SUBARCHITECTURE_DEFINED further resetting;
if HaveThumbEE() then TEECR.XED = '0';
if HaveJazelle() then JMC.R.JE = '0'; SUBARCHITECTURE_DEFINED further resetting;

// Further CPSR changes: all interrupts disabled, IT state reset, instruction set
// and endianness according to the SCTL.R values produced by the above call to
// ResetCP15Registers().
CPSR.I = '1'; CPSR.F = '1'; CPSR.A = '1';
CPSR.IT = '00000000';
CPSR.J = '0'; CPSR.T = SCTL.R.TE; // TE=0: ARM, TE=1: Thumb
CPSR.E = SCTL.R.EE; // EE=0: little-endian, EE=1: big-endian

// All registers, bits and fields not reset by the above pseudocode or by the
// BranchTo() call below are UNKNOWN bitstrings after reset. In particular, the
// return information registers R14_svc and SPSR_svc have UNKNOWN values, so that
// it is impossible to return from a reset in an architecturally defined way.

// Branch to Reset vector.
BranchTo(ExcVectorBase() + 0);

```

The ARM architecture does not define any way of returning from a reset.

B1.6.11 Undefined Instruction exception

An Undefined Instruction exception might be caused by:

- a coprocessor instruction that is not accessible because of the settings in one or both of:
 - the Coprocessor Access Control Register, see *c1, Coprocessor Access Control Register (CPACR)* on page B3-104 for a VMSA implementation, or *c1, Coprocessor Access Control Register (CPACR)* on page B4-51 for a PMSA implementation
 - in an implementation that includes the Security Extensions, the Non-Secure Access Control Register, see *c1, Non-Secure Access Control Register (NSACR)* on page B3-110
- a coprocessor instruction that is not implemented
- an instruction that is UNDEFINED
- an attempt to execute an instruction in an unsupported instruction set state, see *Exception return to an unsupported instruction set state* on page B1-40
- division by zero in an SDIV or UDIV instruction in the ARMv7-R profile when the SCTL.R.DZ bit is set to 1, see *c1, System Control Register (SCTL.R)* on page B4-45.

The Undefined Instruction exception can be used for:

- software emulation of a coprocessor in a system that does not have the physical coprocessor hardware
- *lazy context switching* of coprocessor registers
- general-purpose instruction set extension by software emulation

- signaling an illegal instruction execution
- division by zero errors.

In some coprocessor designs, an internal exceptional condition caused by one coprocessor instruction is signaled asynchronously by refusing to respond to a later coprocessor instruction that belongs to the same coprocessor. In these circumstances, the Undefined Instruction handler must take whatever action is needed to clear the exceptional condition, and then return to the second coprocessor instruction.

———— **Note** ————

The only mechanism to determine the cause of an Undefined Instruction exception is analysis of the instruction indicated by the return link in the LR on exception entry. Therefore it is important that a coprocessor only reports exceptional conditions by generating Undefined Instruction exceptions on its own coprocessor instructions.

The following pseudocode describes how this exception is taken:

```
// TakeUndefInstrException()
// =====

TakeUndefInstrException()
    // Determine return information. SPSR is to be the current CPSR, and LR is to be the
    // current PC minus 2 for Thumb or 4 for ARM, to change the PC offsets of 4 or 8
    // respectively from the address of the current instruction into the required return
    // address offsets of 2 or 4 respectively.
    new_lr_value = if CPSR.T == '1' then PC-2 else PC-4;
    new_spsr_value = CPSR;

    // Enter Undefined ('11011') mode, and ensure Secure state if initially in Monitor
    // ('10110') mode. This affects the banked versions of various registers accessed later
    // in the code.
    if CPSR.M == '10110' then SCR.NS = '0';
    CPSR.M = '11011';

    // Write return information to registers, and make further CPSR changes: IRQs disabled,
    // IT state reset, instruction set and endianness to SCTLR-configured values.
    SPSR[] = new_spsr_value;
    R[14] = new_lr_value;
    CPSR.I = '1';
    CPSR.IT = '00000000';
    CPSR.J = '0'; CPSR.T = SCTLR.TE; // TE=0: ARM, TE=1: Thumb
    CPSR.E = SCTLR.EE; // EE=0: little-endian, EE=1: big-endian

    // Branch to Undefined Instruction vector.
    BranchTo(ExcVectorBase() + 4);
```

The preferred exception return from an Undefined Instruction exception is a return to the instruction that generated the exception. Use the LR and SPSR values generated by the exception entry to produce this return as follows:

- If SPSR.J and SPSR.T are both 0, indicating that the exception occurred in ARM state, use an exception return instruction with a subtraction of 4

- If SPSR.J and SPSR.T are not both 0, indicating that the exception occurred in Thumb state or ThumbEE state, use an exception return instruction with a subtraction of 2.

For more information, see *Exception return* on page B1-38.

Note

- Undefined Instruction exceptions cannot occur in Jazelle state
 - If handling the Undefined Instruction exception requires instruction emulation, followed by return to the next instruction after the instruction that caused the exception, the instruction emulator must use the instruction length to calculate the correct return address, and to calculate the updated values of the IT bits if necessary.
-

Conditional execution of undefined instructions

The conditional execution rules described in *Conditional execution* on page A8-8 apply to all instructions. This includes UNDEFINED instructions and other instructions that would cause entry to the Undefined Instruction exception.

If such an instruction fails its condition check, the behavior depends on the architecture profile and the potential cause of entry to the Undefined Instruction exception, as follows:

- In the ARMv7-A profile:
 - If the potential cause is the execution of the instruction itself and depends on data values the instruction reads, the instruction executes as a NOP and does not cause an Undefined Instruction exception.
 - If the potential cause is the execution of an earlier coprocessor instruction, or the execution of the instruction itself but does not depend on data values the instruction reads, it is IMPLEMENTATION DEFINED whether the instruction executes as a NOP or causes an Undefined Instruction exception.
An implementation must handle all such cases in the same way.
- In the ARMv7-R profile, the instruction executes as a NOP and does not cause an Undefined Instruction exception.

Note

Before ARMv7, all implementations executed any instruction that failed its condition check as a NOP, even if it would otherwise have caused an Undefined Instruction exception. Undefined Instruction handlers written for these implementations might assume without checking that the undefined instruction passed its condition check. Such Undefined Instruction handlers are likely to need rewriting, to check the condition is passed, before they function correctly on all ARMv7-A implementations.

B1.6.12 Supervisor Call (SVC) exception

The Supervisor Call instruction SVC enters Supervisor mode and requests a supervisor function. Typically, the SVC instruction is used to request an operating system function. For more information, see *SVC (previously SWI)* on page A8-430.

———— Note ————

In previous versions of the ARM architecture, the SVC instruction was called SWI, Software Interrupt.

The following pseudocode describes how this exception is taken:

```
// TakeSVCException()
// =====

TakeSVCException()
// Determine return information. SPSR is to be the current CPSR, after changing the IT[]
// bits to give them the correct values for the following instruction, and LR is to be
// the current PC minus 2 for Thumb or 4 for ARM, to change the PC offsets of 4 or 8
// respectively from the address of the current instruction into the required address of
// the next instruction (the SVC instruction having size 2 or 4 bytes respectively).
ITAdvance();
new_lr_value = if CPSR.T == '1' then PC-2 else PC-4;
new_spsr_value = CPSR;

// Enter Supervisor ('10011') mode, and ensure Secure state if initially in Monitor
// ('10110') mode. This affects the banked versions of various registers accessed later
// in the code.
if CPSR.M == '10110' then SCR.NS = '0';
CPSR.M = '10011';

// Write return information to registers, and make further CPSR changes: IRQs disabled,
// IT state reset, instruction set and endianness to SCTLR-configured values.
SPSR[] = new_spsr_value;
R[14] = new_lr_value;
CPSR.I = '1';
CPSR.IT = '00000000';
CPSR.J = '0'; CPSR.T = SCTLR.TE; // TE=0: ARM, TE=1: Thumb
CPSR.E = SCTLR.EE; // EE=0: little-endian, EE=1: big-endian

// Branch to SVC vector.
BranchTo(ExcVectorBase() + 8);
```

The preferred exception return from an SVC exception is a return to the next instruction after the SVC instruction. Use the LR and SPSR values generated by the exception entry to produce this return by using an exception return instruction without a subtraction.

For more information, see *Exception return* on page B1-38.

B1.6.13 Secure Monitor Call (SMC) exception

The Secure Monitor Call instruction SMC enters Monitor mode and requests a Monitor function. For more information, see *SMC (previously SMI)* on page B6-18.

———— **Note** ————

In previous versions of the ARM architecture, the SMC instruction was called SMI, Software Monitor Interrupt.

The following pseudocode describes how this exception is taken:

```
// TakeSMCException()
// =====

TakeSMCException()
// Determine return information. SPSR is to be the current CPSR, after changing the IT[]
// bits to give them the correct values for the following instruction, and LR is to be
// the current PC minus 0 for Thumb or 4 for ARM, to change the PC offsets of 4 or 8
// respectively from the address of the current instruction into the required address of
// the next instruction (with the SMC instruction always being 4 bytes in length).
ITAdvance();
new_lr_value = if CPSR.T == '1' then PC else PC-4;
new_spsr_value = CPSR;

// Enter Monitor ('10110') mode, and ensure Secure state if initially in Monitor mode.
// This affects the banked versions of various registers accessed later in the code.
if CPSR.M == '10110' then SCR.NS = '0';
CPSR.M = '10110';

// Write return information to registers, and make further CPSR changes: interrupts
// disabled, IT state reset, instruction set and endianness to SCTLR-configured values.
SPSR[] = new_spsr_value;
R[14] = new_lr_value;
CPSR.I = '1'; CPSR.F = '1'; CPSR.A = '1';
CPSR.IT = '00000000';
CPSR.J = '0'; CPSR.T = SCTLR.TE; // TE=0: ARM, TE=1: Thumb
CPSR.E = SCTLR.EE; // EE=0: little-endian, EE=1: big-endian

// Branch to SMC vector.
BranchTo(MVBAR + 8);
```

The preferred exception return from an SMC exception is a return to the next instruction after the SMC instruction. Use the LR and SPSR values generated by the exception entry to produce this return by using an exception return instruction without a subtraction.

For more information, see *Exception return* on page B1-38.

———— **Note** ————

You can return to the SMC instruction itself by returning using a subtraction of 4, without any adjustment to the SPSR.IT[7:0] bits. The result is that the return occurs, then interrupts or external aborts might occur and be handled, then the SMC instruction is re-executed and another SMC exception occurs.

This relies on:

- the SMC instruction being used correctly, either outside an IT block or as the last instruction in an IT block, so that the SPSR.IT[7:0] bits indicate unconditional execution
 - the SMC handler not changing the result of the original conditional execution test for the SMC instruction.
-

B1.6.14 Prefetch Abort exception

A Prefetch Abort exception can be generated by:

- A synchronous memory abort on an instruction fetch.

———— **Note** ————

Asynchronous aborts on instruction fetches are reported using the Data Abort exception, see *Data Abort exception* on page B1-55.

Prefetch Abort exception entry is synchronous to the instruction whose instruction fetch aborted. If an implementation prefetches instructions, it must handle a synchronous abort on an instruction prefetch by:

- generating a Prefetch Abort exception if and when the instruction is about to execute
- ignoring the abort if the instruction does not reach the point of being about to execute, for example, if a branch misprediction or exception entry occurs before the instruction is reached.

For more information about memory aborts see:

- *VMSA memory aborts* on page B3-40
- *PMSA memory aborts* on page B4-13.

- A Breakpoint, Vector Catch or BKPT Instruction debug event, see *Debug exception on Breakpoint, BKPT Instruction or Vector Catch debug events* on page C4-2.

The following pseudocode describes how this exception is taken:

```
// TakePrefetchAbortException()
// =====

TakePrefetchAbortException()
    // Determine return information. SPSR is to be the current CPSR, and LR is to be the
    // current PC minus 0 for Thumb or 4 for ARM, to change the PC offsets of 4 or 8
    // respectively from the address of the current instruction into the required address
    // of the current instruction plus 4.
    new_lr_value = if CPSR.T == '1' then PC else PC-4;
```

```

new_spsr_value = CPSR;

// Determine whether this is an external abort to be trapped to Monitor mode.
trap_to_monitor = HaveSecurityExt() && SCR.EA == '1' && IsExternalAbort();

// Enter Abort ('10111') or Monitor ('10110') mode, and ensure Secure state if
// initially in Monitor mode. This affects the banked versions of various registers
// accessed later in the code.
if CPSR.M == '10110' then SCR.NS = '0';
CPSR.M = if trap_to_monitor then '10110' else '10111';

// Write return information to registers, and make further CPSR changes: IRQs disabled,
// other interrupts disabled if appropriate, IT state reset, instruction set and
// endianness to SCTLR-configured values.
SPSR[] = new_spsr_value;
R[14] = new_lr_value;
CPSR.I = '1';
if trap_to_monitor then
    CPSR.F = '1'; CPSR.A = '1';
else
    if !HaveSecurityExt() || SCR.NS == '0' || SCR.AW == '1' then CPSR.A = '1';
CPSR.IT = '00000000';
CPSR.J = '0'; CPSR.T = SCTLR.TE; // TE=0: ARM, TE=1: Thumb
CPSR.E = SCTLR.EE; // EE=0: little-endian, EE=1: big-endian

// Branch to correct Prefetch Abort vector.
if trap_to_monitor then
    BranchTo(MVBAR + 12);
else
    BranchTo(ExcVectorBase() + 12);

```

The preferred exception return from a Prefetch Abort exception is a return to the aborted instruction. Use the LR and SPSR values generated by the exception entry to produce this return by using an exception return instruction with a subtraction of 4.

For more information, see *Exception return* on page B1-38.

B1.6.15 Data Abort exception

A Data Abort exception can be generated by:

- A synchronous abort on a data read or write memory access. Exception entry is synchronous to the instruction that generated the memory access.
- An asynchronous abort. The memory access that caused the abort can be any of:
 - a data read or write access
 - an instruction fetch or prefetch
 - in a VMSA memory system, a translation table access.

Exception entry occurs asynchronously. It is similar to an interrupt, but uses either Abort mode or Monitor mode, and the associated banked registers. Setting the CPSR.A bit prevents asynchronous aborts ~~from occurring~~.



Note

There are no asynchronous internal aborts in ARMv7 and earlier architecture versions, so asynchronous aborts are always asynchronous external aborts.

- A Watchpoint debug event, see *Debug exception on Watchpoint debug event* on page C4-3.

Note

A Data Abort exception generated by a Watchpoint debug event can be either asynchronous or synchronous, but is not an abort. This means that if it is asynchronous, it is an asynchronous Data Abort exception but not an asynchronous abort.

For more information about memory aborts see:

- *VMSA memory aborts* on page B3-40
- *PMSA memory aborts* on page B4-13.

The following pseudocode describes how this exception is taken:

```
// TakeDataAbortException()
// =====

TakeDataAbortException()
    // Determine return information. SPSR is to be the current CPSR, and LR is to be the
    // current PC plus 4 for Thumb or 0 for ARM, to change the PC offsets of 4 or 8
    // respectively from the address of the current instruction into the required address
    // of the current instruction plus 8. For an asynchronous abort, the PC and CPSR are
    // considered to have already moved on to their values for the instruction following
    // the instruction boundary at which the exception occurred.
    new_lr_value = if CPSR.T == '1' then PC+4 else PC;
    new_spsr_value = CPSR;

    // Determine whether this is an external abort to be trapped to Monitor mode.
    trap_to_monitor = HaveSecurityExt() && SCR.EA == '1' && IsExternalAbort();

    // Enter Abort ('10111') or Monitor ('10110') mode, and ensure Secure state if
    // initially in Monitor mode. This affects the banked versions of various registers
    // accessed later in the code.
    if CPSR.M == '10110' then SCR.NS = '0';
    CPSR.M = if trap_to_monitor then '10110' else '10111';

    // Write return information to registers, and make further CPSR changes: IRQs disabled,
    // other interrupts disabled if appropriate, IT state reset, instruction set and
    // endianness to SCTLR-configured values.
    SPSR[] = new_spsr_value;
    R[14] = new_lr_value;
    CPSR.I = '1';
    if trap_to_monitor then
        CPSR.F = '1'; CPSR.A = '1';
    else
        if !HaveSecurityExt() || SCR.NS == '0' || SCR.AW == '1' then CPSR.A = '1';
        CPSR.IT = '00000000';
```

```

CPSR.J = '0'; CPSR.T = SCTLR.TE; // TE=0: ARM, TE=1: Thumb
CPSR.E = SCTLR.EE; // EE=0: little-endian, EE=1: big-endian

// Branch to correct Data Abort vector.
if trap_to_monitor then
    BranchTo(MVBAR + 16);
else
    BranchTo(ExcVectorBase() + 16);

```

The preferred exception return from a Data Abort exception is a return to the instruction that generated the aborting memory access, or to the instruction following the instruction boundary at which an asynchronous Data Abort exception occurred. Use the LR and SPSR values generated by the exception entry to produce this return by using an exception return instruction with a subtraction of 8.

For more information, see *Exception return* on page B1-38.

Effects of data-aborted instructions

Instructions that access data memory can modify memory by storing one or more values. If a Data Abort exception is generated by executing such an instruction, the value of each memory location that the instruction stores to is:

- unchanged if the memory system does not permit write access to the memory location
- UNKNOWN otherwise.

Instructions that access data memory can modify registers in the following ways:

- By loading values into one or more of the general-purpose registers. The registers loaded can include the PC.
- By specifying *base register write-back*, in which the base register used in the address calculation has a modified value written to it. All instructions that support base register write-back have UNPREDICTABLE results if this is specified with the PC as the base register. Only general-purpose registers other than the PC can be modified reliably in this way.
- By loading values into coprocessor registers.
- By modifying the CPSR.

If a synchronous Data Abort exception is generated by executing such an instruction, the following rules determine the values left in these registers:

1. On entry to the Data Abort handler:
 - the PC value is the Data Abort vector address, see *Exception vectors and the exception base address* on page B1-30
 - the LR_abt value is determined from the address of the aborted instruction.

Neither value is affected in any way by the results of any load specified by the instruction.
2. The base register is restored to its original value if either:
 - the aborted instruction is a load that includes the base register in the list to be loaded

- the base register is being written back.
3. If the instruction only loads one general-purpose register, the value in that register is unchanged.
 4. If the instruction loads more than one general-purpose register, UNKNOWN values are left in destination registers other than the PC and the base register of the instruction.
 5. If the instruction loads coprocessor registers, UNKNOWN values are left in the destination coprocessor registers.
 6. CPSR bits that are not defined as updated on exception entry retain their current value.
 7. ~~If a synchronous Data Abort exception is generated by execution of a STREX, STREXB, STREXH, or STREXD instruction:~~
 - ~~memory is not updated~~
 - ~~<Rd> is not updated~~
 - ~~it is UNPREDICTABLE whether the monitor changes from the Exclusive state to the Open state.~~



The ARM abort model

The abort model used by an ARM processor implementation is described as a *Base Restored Abort Model*. This means that if a synchronous Data Abort exception is generated by executing an instruction that specifies base register write-back, the value in the base register is unchanged.

———— Note ————

In versions of the ARM architecture before ARMv6, it is IMPLEMENTATION DEFINED whether the abort model used is the *Base Restored Abort Model* or the *Base Updated Abort Model*. For more information, see *The ARM abort model* on page AppxH-20.

The abort model applies uniformly across all instructions.

B1.6.16 IRQ exception

The IRQ exception is generated by IMPLEMENTATION DEFINED means. Typically this is by asserting an IRQ interrupt request input to the processor.

Whether and how an IRQ exception is taken depends on the CPSR.I and SCTL.R.FI bits:

- If CPSR.I == 1, IRQ exceptions are disabled and are not taken.
- If CPSR.I == 0 and SCTL.R.FI == 0, IRQ exceptions can be taken. In this case IRQ exception entry is precise to an instruction boundary.

- If `CPSR.I == 0` and `SCTLR.FI == 1`, IRQ exceptions can be taken. In this case IRQ exception entry is precise to an instruction boundary, except that some of the effects of the instruction that follows that boundary might have occurred. These effects are restricted to those that can be repeated idempotently and without breaking the rules in *Single-copy atomicity* on page A3-27. Examples of such effects are:
 - changing the value of a register that the instruction writes but does not read
 - performing an access to Normal memory.

————— **Note** —————

This relaxation of the normal definition of a precise asynchronous exception permits interrupts to occur during the execution of instructions that change register or memory values, while only requiring the implementation to restore those register values that are needed to correctly re-execute the instruction after the preferred exception return. LDM and STM are examples of such instructions.

The following pseudocode describes how this exception is taken:

```
// TakeIRQException()
// =====

TakeIRQException()
// Determine return information. SPSR is to be the current CPSR, and LR is to be the
// current PC minus 0 for Thumb or 4 for ARM, to change the PC offsets of 4 or 8
// respectively from the address of the current instruction into the required address
// of the instruction boundary at which the interrupt occurred plus 4. For this
// purpose, the PC and CPSR are considered to have already moved on to their values
// for the instruction following that boundary.
new_lr_value = if CPSR.T == '1' then PC else PC-4;
new_spsr_value = CPSR;

// Determine whether IRQs are trapped to Monitor mode.
trap_to_monitor = HaveSecurityExt() && SCR.IRQ == '1';

// Enter IRQ ('10010') or Monitor ('10110') mode, and ensure Secure state if initially
// in Monitor mode. This affects the banked versions of various registers accessed
// later in the code.
if CPSR.M == '10110' then SCR.NS = '0';
CPSR.M = if trap_to_monitor then '10110' else '10010';

// Write return information to registers, and make further CPSR changes: IRQs disabled,
// other interrupts disabled if appropriate, IT state reset, instruction set and
// endianness to SCTLR-configured values.
SPSR[] = new_spsr_value;
R[14] = new_lr_value;
CPSR.I = '1';
if trap_to_monitor then
    CPSR.F = '1'; CPSR.A = '1';
else
    if !HaveSecurityExt() || SCR.NS == '0' || SCR.AW == '1' then CPSR.A = '1';
CPSR.IT = '00000000';
CPSR.J = '0'; CPSR.T = SCTLR.TE; // TE=0: ARM, TE=1: Thumb
CPSR.E = SCTLR.EE; // EE=0: little-endian, EE=1: big-endian
```

```

// Branch to correct IRQ vector.
if trap_to_monitor then
    BranchTo(MVBAR + 24);
elsif SCTLR.VE == '1' then
    IMPLEMENTATION_DEFINED branch to an IRQ vector;
else
    BranchTo(ExcVectorBase() + 24);

```

The preferred exception return from an IRQ interrupt is a return to the instruction following the instruction boundary at which the interrupt occurred. Use the LR and SPSR values generated by the exception entry to produce this return by using an exception return instruction with a subtraction of 4.

For more information, see *Exception return* on page B1-38.

B1.6.17 FIQ exception

The FIQ exception is generated by IMPLEMENTATION DEFINED means. Typically this is by asserting an FIQ interrupt request input to the processor.

Whether and how an FIQ exception is taken depends on the CPSR.F and SCTLR.FI bits:

- If CPSR.F == 1, FIQ exceptions are disabled and are not taken.
- If CPSR.F == 0 and SCTLR.FI == 0, FIQ exceptions can be taken. In this case FIQ exception entry is precise to an instruction boundary.
- If CPSR.F == 0 and SCTLR.FI == 1, FIQ exceptions can be taken. In this case FIQ exception entry is precise to an instruction boundary, except that some of the effects of the instruction that follows that boundary might have occurred. These effects are restricted to those that can be repeated idempotently and without breaking the rules in *Single-copy atomicity* on page A3-27. Examples of such effects are:
 - changing the value of a register that the instruction writes but does not read
 - performing an access to Normal memory.

———— Note —————

This relaxation of the normal definition of a precise asynchronous exception permits interrupts to occur during the execution of instructions that change register or memory values, while only requiring the implementation to restore those register values that are needed to correctly re-execute the instruction after the preferred exception return. LDM and STM are examples of such instructions.

The FIQ vector is the last vector in the vector table. This means the FIQ exception handler can be placed directly at the FIQ vector address, see *Exception vectors and the exception base address* on page B1-30. For example, if High vectors are enabled and VE == 0 the FIQ exception handler software can be placed at 0xFFFF001C. This avoids a branch instruction from the vector.

The following pseudocode describes how this exception is taken:

```

// TakeFIQException()
// =====

```

```

TakeFIQException()
// Determine return information. SPSR is to be the current CPSR, and LR is to be the
// current PC minus 0 for Thumb or 4 for ARM, to change the PC offsets of 4 or 8
// respectively from the address of the current instruction into the required address
// of the instruction boundary at which the interrupt occurred plus 4. For this
// purpose, the PC and CPSR are considered to have already moved on to their values
// for the instruction following that boundary.
new_lr_value = if CPSR.T == '1' then PC else PC-4;
new_spsr_value = CPSR;

// Determine whether FIQs are trapped to Monitor mode.
trap_to_monitor = HaveSecurityExt() && SCR.FIQ == '1';

// Enter FIQ ('10001') or Monitor ('10110') mode, and ensure Secure state if initially
// in Monitor mode. This affects the banked versions of various registers accessed
// later in the code.
if CPSR.M == '10110' then SCR.NS = '0';
CPSR.M = if trap_to_monitor then '10110' else '10001';

// Write return information to registers, and make further CPSR changes: IRQs disabled,
// other interrupts disabled if appropriate, IT state reset, instruction set and
// endianness to SCTLR-configured values.
SPSR[] = new_spsr_value;
R[14] = new_lr_value;
CPSR.I = '1';
if trap_to_monitor then
    CPSR.F = '1'; CPSR.A = '1';
else
    if !HaveSecurityExt() || SCR.NS == '0' || SCR.FW == '1' then CPSR.F = '1';
    if !HaveSecurityExt() || SCR.NS == '0' || SCR.AW == '1' then CPSR.A = '1';
CPSR.IT = '00000000';
CPSR.J = '0'; CPSR.T = SCTLR.TE; // TE=0: ARM, TE=1: Thumb
CPSR.E = SCTLR.EE; // EE=0: little-endian, EE=1: big-endian

// Branch to correct FIQ vector.
if trap_to_monitor then
    BranchTo(MVBAR + 28);
elseif SCTLR.VE == '1' then
    IMPLEMENTATION_DEFINED branch to an FIQ vector;
else
    BranchTo(ExcVectorBase() + 28);

```

The preferred exception return from an FIQ interrupt is a return to the instruction following the instruction boundary at which the interrupt occurred. Use the LR and SPSR values generated by the exception entry to produce this return by using an exception return instruction with a subtraction of 4.

For more information, see *Exception return* on page B1-38.

B1.7 Coprocessors and system control

The ARM architecture supports sixteen coprocessors, usually referred to as CP0 to CP15. These coprocessors are introduced in *Coprocessor support* on page A2-68. The architecture reserves two of these coprocessors, CP14 and CP15, for configuration and control related to the architecture:

- CP14 is reserved for the configuration and control of:
 - debug features, see *The CP14 debug register interfaces* on page C6-32
 - execution environment features, see *Execution environment support* on page B1-73.
- CP15 is called the System Control coprocessor, and is reserved for the control and configuration of the ARM processor system, including architecture and feature identification.

This section gives:

- general information about the CP15 registers, in *CP15 System Control coprocessor registers*
- information about access controls for coprocessors CP0 to CP13, in *Access controls on CP0 to CP13* on page B1-63.

B1.7.1 CP15 System Control coprocessor registers

The implementation of the CP15 registers depends heavily on whether the ARMv7 implementation is:

- an ARMv7-A implementation with a *Virtual Memory System Architecture* (VMSA)
- an ARMv7-R implementation with a *Protected Memory System Architecture* (PMSA).

Therefore, detailed descriptions of the CP15 registers are given in:

- *CP15 registers for a VMSA implementation* on page B3-64
- *CP15 registers for a PMSA implementation* on page B4-22.

Registers that are common to VMSA and PMSA implementations are described in both of these sections. Some registers are implemented differently in VMSA and PMSA implementations.

Those descriptions do not include the registers that implement the processor identification scheme, CPUID. The CPUID registers are described in Chapter B5 *The CPUID Identification Scheme*.

CP15, the System Control coprocessor, can contain up to 16 primary registers, each of which is 32 bits long. The CP15 register access instructions define the required primary register. Additional fields in the instruction are used to refine the access, and increase the number of physical 32-bit registers in CP15. In descriptions of the System Control coprocessor the 4-bit primary register number is used as a top level register identifier, because it is the primary factor determining the function of the register. The 16 primary registers in CP15 are identified as c0 to c15.

For details of register access rights and restrictions see the descriptions of the individual registers. In ARMv7-A implementations, see also *Effect of the Security Extensions on the CP15 registers* on page B3-71.

The CP15 register access instructions are:

- MCR, to write an ARM core register to a CP15 register, see *MCR, MCR2* on page A8-186
- MRC, to read the value of a CP15 register into an ARM core register, see *MRC, MRC2* on page A8-202.

All CP15 CDP, CDP2, LDC, LDC2, MCR2, MCRR, MCRR2, MRC2, MRRC, MRRC2, STC, and STC2 instructions are UNDEFINED.

B1.7.2 Access controls on CP0 to CP13

Coprocessors CP0 to CP13 might be required for optional features of the ARMv7 implementation. In particular, CP10 and CP11 are used to support floating-point operations through the VFP and Advanced SIMD extensions to the architecture, see *Advanced SIMD and floating-point support* on page B1-64.

Coprocessors CP0 to CP7 can be used to provide IMPLEMENTATION DEFINED vendor specific features.

Access to the coprocessors CP0 to CP13 is controlled by the Coprocessor Access Control Register, see:

- *c1*, *Coprocessor Access Control Register (CPACR)* on page B3-104 for a VMSA implementation
- *c1*, *Coprocessor Access Control Register (CPACR)* on page B4-51 for a PMSA implementation.

Initially on power up or reset, access to coprocessors CP0 to CP13 is disabled.

When the Security Extensions are implemented, the Non-Secure Access Control Register determines which of the CP0 to CP13 coprocessors can be accessed from the Non-secure state, see *c1*, *Non-Secure Access Control Register (NSACR)* on page B3-110.

Note

- When an implementation includes either or both of the VFP and Advanced SIMD extensions, the access settings for CP10 and CP11 must be identical. If these settings are not identical the behavior of the extensions is UNPREDICTABLE.
 - To check which coprocessors are implemented:
 1. If required, read the Coprocessor Access Control Register and save the value.
 2. Write the value 0x0FFFFFFF to the register, to write 0b11 to the access field for each of the coprocessors CP13 to CP0.
 3. Read the Coprocessor Access Control Register again and check the access field for each coprocessor:
 - if the access field value is 0b00 the coprocessor is not implemented
 - if the access field value is 0b11 the coprocessor is implemented.
 4. If required, write the value from stage 1 back to the register to restore the original value.
-

B1.8 Advanced SIMD and floating-point support

Advanced SIMD and VFP extensions on page A2-20 introduces:

- the VFP extension, used for scalar floating-point operations
- the Advanced SIMD extension, used for integer and floating-point vector operations
- the Advanced SIMD and VFP extension registers D0 - D31 and their alternative views as S0 - S31 and Q0 - Q15
- the *Floating-Point Status and Control Register (FPSCR)*.

For more information about the system registers for the Advanced SIMD and VFP extensions see *Advanced SIMD and VFP extension system registers* on page B1-66.

Software can interrogate the registers described in *Advanced SIMD and VFP feature identification registers* on page B5-34 to discover the Advanced SIMD and floating-point support implemented in a system.

This section gives more information about the Advanced SIMD and VFP extensions, in the subsections:

- *Enabling Advanced SIMD and floating-point support*
- *Advanced SIMD and VFP extension system registers* on page B1-66
- *The Floating-Point Exception Register (FPEXC)* on page B1-68
- *Context switching with the Advanced SIMD and VFP extensions* on page B1-69
- *VFP support code* on page B1-70
- *VFP subarchitecture support* on page B1-72.

B1.8.1 Enabling Advanced SIMD and floating-point support

If an ARMv7 implementation includes support for any Advanced SIMD or VFP features then the boot software for any system that uses that implementation must ensure that:

- access to CP10 and CP11 is enabled in the Coprocessor Access Control Register, see:
 - *c1, Coprocessor Access Control Register (CPACR)* on page B3-104 for a VMSA implementation
 - *c1, Coprocessor Access Control Register (CPACR)* on page B4-51 for a PMSA implementation.
- if the Security Extensions are implemented and Non-secure access to the Advanced SIMD or VFP features is required, the access flags for CP10 and CP11 in the NSACR must be set to 1, see *c1, Non-Secure Access Control Register (NSACR)* on page B3-110.

If this is not done, operation of Advanced SIMD and VFP features is UNDEFINED.

If the access control bits are programmed differently for CP10 and CP11, operation of Advanced SIMD and VFP features is UNPREDICTABLE.

In addition, software must set the FPEXC.EN bit to 1 to enable most Advanced SIMD and VFP operations, see *The Floating-Point Exception Register (FPEXC)* on page B1-68.

When floating-point operation is disabled because FPEXC.EN is 0, all Advanced SIMD and VFP instructions are treated as Undefined Instructions except for:

- a VMSR to the FPEXC or FPSID register
- a VMRS from the FPEXC, FPSID, MVFR0, or MVFR1 register.

These instructions can be executed only in privileged modes.

Note

- When FPEXC.EN == 0, these operations are treated as Undefined Instructions:
 - a VMSR to the FPSCR
 - a VMRS from the FPSCR
 - If a VFP implementation contains system registers additional to the FPSID, FPSCR, FPEXC, MVFR0, and MVFR1 registers, the behavior of VMSR instructions to them and VMRS instructions from them is SUBARCHITECTURE DEFINED.
-

Pseudocode details of enabling the Advanced SIMD and VFP extensions

The following pseudocode takes appropriate action if an Advanced SIMD or VFP instruction is used when the extensions are not enabled:

```
// CheckAdvSIMDorVFPEnabled()
// =====

CheckAdvSIMDorVFPEnabled(boolean include_fpxc_check, boolean advsimd)
    if HaveSecurityExt() then
        // Check Non-secure Access Control Register for permission to use CP10/11.
        if NSACR.cp10 != NSACR.cp11 then UNPREDICTABLE;
        if SCR.NS == '1' && NSACR.cp10 == '0' then UNDEFINED;

        // Check Coprocessor Access Control Register for permission to use CP10/11.
        if CPACR.cp10 != CPACR.cp11 then UNPREDICTABLE;
        case CPACR.cp10 of
            when '00' UNDEFINED;
            when '01' if !CurrentModeIsPrivileged() then UNDEFINED; // else CPACR permits access
            when '10' UNPREDICTABLE;
            when '11' // CPACR permits access

        // If the Advanced SIMD extension is specified, check whether it is disabled.
        if advsimd && CPACR.ASEDIS == '1' then UNDEFINED;

        // If required, check FPEXC enabled bit.
        if include_fpxc_check && FPEXC.EN == '0' then UNDEFINED;

    return;

// CheckAdvSIMDEnabled()
// =====

CheckAdvSIMDEnabled()
```

```

return CheckAdvSIMDorVFPEEnabled(TRUE, TRUE);

// CheckVFPEEnabled()
// =====

CheckVFPEEnabled(boolea include_fpexc_check)
return CheckAdvSIMDorVFPEEnabled(include_fpexc_check, FALSE);

```

B1.8.2 Advanced SIMD and VFP extension system registers

The Advanced SIMD and VFP extensions share a common set of special-purpose registers. Any ARMv7 implementation that includes either or both of these extensions must implement these registers. This section gives general information about this set of registers, and indicates where each register is described in detail. It contains the following subsections:

- *Register map of the Advanced SIMD and VFP extension system registers*
- *Accessing the Advanced SIMD and VFP extension system registers* on page B1-67.

Register map of the Advanced SIMD and VFP extension system registers

Table B1-11 shows the register map of the Advanced SIMD and VFP registers. When the Security Extensions are implemented, the Advanced SIMD and VFP registers are not banked.

Table B1-11 Advanced SIMD and VFP common register block

System register	Name	Description
0b0000	FPSID	See <i>Floating-point System ID Register (FPSID)</i> on page B5-34
0b0001	FPSCR	See <i>Floating-point Status and Control Register (FPSCR)</i> on page A2-28
0b0010- 0b0101	Reserved	All accesses are UNPREDICTABLE
0b0110	MVFR1	Media and VFP Feature Registers 1 and 0, see <i>Media and VFP Feature registers</i> on page B5-36
0b0111	MVFR0	
0b1000	FPEXC	See <i>The Floating-Point Exception Register (FPEXC)</i> on page B1-68
0b1001-0b1111	SUBARCHITECTURE DEFINED	-

Note

- Appendix B *Common VFP Subarchitecture Specification* includes examples of how a VFP subarchitecture might define additional registers, in the SUBARCHITECTURE DEFINED register space using addresses in the 0b1001 to 0b1111 range.
 - Appendix B is not part of the ARMv7 architecture. It is included as an example of how a VFP subarchitecture might be defined.
-

Accessing the Advanced SIMD and VFP extension system registers

You access the Advanced SIMD and VFP extension system registers using the VMRS and VMSR instructions, see:

- VMRS on page [A8-658](#)
- VMSR on page [A8-660](#).

For example:

```
VMRS <Rt>, FPSID    ; Read Floating-Point System ID Register
VMRS <Rt>, MVFR1    ; Read Media and VFP Feature Register 1
VMSR FPSCR, <Rt>   ; Write Floating-Point System Control Register
```

You must enable access to CP10 and CP11 in the Coprocessor Access Control register before you can access any of the Advanced SIMD and VFP extension system registers, see *Enabling Advanced SIMD and floating-point support* on page B1-64.

To enable access to the FPSCR you must also set the EN flag in the FPEXC Register to 1, see *The Floating-Point Exception Register (FPEXC)* on page B1-68.

Table B1-12 shows the permitted accesses to the Advanced SIMD and VFP extension system registers when the access rights to CP10 and CP11 are sufficient.

Table B1-12 Access to Advanced SIMD and VFP system registers

Register	Register access	Privileged accesses		User accesses	
		EN == 0 ^a	EN == 1 ^a	EN == 0 ^a	EN == 1 ^a
FPSID	Read-only	Permitted	Permitted	Not permitted	Not permitted
FPSCR	Read/write	Not permitted	Permitted	Not permitted	Permitted
MVFR1, MVFR0	Read-only	Permitted	Permitted	Not permitted	Not permitted
FPEXC	Read/write	Permitted	Permitted	Not permitted	Not permitted

a. In the FPEXC Register, see *The Floating-Point Exception Register (FPEXC)* on page B1-68.

———— **Note** ————

All hardware ID information can be accessed only from privileged modes.

The FPSID is privileged access only.

This is a change in VFPv3. In VFPv2 implementations the FPSID register can be accessed in all modes.

The MVFR registers are privileged access only.

User code must issue a system call to determine what features are supported.

B1.8.3 The Floating-Point Exception Register (FPEXC)

The Floating-Point Exception Register (FPEXC) provides global enable and disable control of the Advanced SIMD and VFP extensions, and to indicate how the state of these extensions is recorded.

The FPEXC:

- Is in the CP10 and CP11 register space.
- Is present only when at least one of the VFP and Advanced SIMD extensions is implemented.
- Is a 32-bit read/write register, that can have different access rights for different bits.
- If the Security Extensions are implemented, is a Configurable access register. The FPEXC is only accessible in the Non-secure state if the CP10 and CP11 bits in the NSACR are set to 1, see *c1, Non-Secure Access Control Register (NSACR)* on page B3-110
- Is accessible only in privileged modes, and only if access to coprocessors CP10 and CP11 is enabled in the Coprocessor Access Control Register, see:
 - *c1, Coprocessor Access Control Register (CPACR)* on page B3-104 for a VMSA implementation
 - *c1, Coprocessor Access Control Register (CPACR)* on page B4-51 for a PMSA implementation.
- Has a reset value of 0 for bit [30], FPEXC.EN.

The format of the FPEXC is:



EX, bit [31] Exception bit. A status bit that specifies how much information must be saved to record the state of the Advanced SIMD and VFP system:

- 0** The only significant state is the contents of the registers:
 - D0 - D15
 - D16 - D31, if implemented

- FPSCR
- FPEXC.

A context switch can be performed by saving and restoring the values of these registers.

1 There is additional state that must be handled by any context switch system.

The behavior of the EX bit on writes is SUBARCHITECTURE DEFINED, except that in any implementation a write of 0 to this bit must be a valid operation, and must return a value of 0 if read back immediately.

EN, bit [30] Enable bit. A global enable for the Advanced SIMD and VFP extensions:

0 The Advanced SIMD and VFP extensions are disabled. For details of how the system operates when EN == 0 see *Enabling Advanced SIMD and floating-point support* on page B1-64.

1 The Advanced SIMD and VFP extensions are enabled and operate normally.

This bit is always a normal read/write bit. It has a reset value of 0.

Bits [29:0] SUBARCHITECTURE DEFINED. An implementation can use these bits to communicate exception information between the floating-point hardware and the support code. The subarchitectural definition of these bits includes their read/write access. This can be defined on a bit by bit basis.

A constraint on these bits is that if EX == 0 it must be possible to save and restore all significant state for the floating-point system by saving and restoring only the two Advanced SIMD and VFP extension registers FPSCR and FPEXC.

Writes to the FPEXC can have side-effects on various aspects of processor operation. All of these side-effects are synchronous to the FPEXC write. This means they are guaranteed not to be visible to earlier instructions in the execution stream, and they are guaranteed to be visible to later instructions in the execution stream.

See *Advanced SIMD and VFP extension system registers* on page B1-66 for an overview of the common set of system registers for the Advanced SIMD and VFP extensions.

B1.8.4 Context switching with the Advanced SIMD and VFP extensions

In an implementation that includes one or both of the Advanced SIMD and VFP extensions, if the VFP registers are used by only a subset of processes, the operating system might implement lazy context switching of the extension registers and extension system registers.

In the simplest lazy context switch implementation, the primary context switch code simply disables the VFP and Advanced SIMD extensions, by disabling access to coprocessors CP10 and CP11 in the Coprocessor Access Control Register, see *Enabling Advanced SIMD and floating-point support* on page B1-64. Subsequently, when a process or thread attempts to use an Advanced SIMD or VFP instruction, it triggers an Undefined Instruction exception. The operating system responds by saving and restoring the extension registers and extension system registers.

B1.8.5 VFP support code

A complete VFP implementation might require a software component, known as the *support code*. For example, if VFPv3U is implemented support code must handle the trapped floating-point exceptions.

Typically, the support code is entered through the ARM Undefined Instruction vector, when the extension hardware does not respond to a VFP instruction. This software entry is known as a *bounce*.

When VFPv3U is implemented, the bounce mechanism is used to support trapped floating-point exceptions. Trapped floating-point exceptions, known as *traps*, are floating-point exceptions that an implementation passes back to application software to resolve, see *Floating-point exceptions* on page A2-42. The support code must catch a trapped exception and convert it into a trap handler call.

The support code can perform other tasks, as determined by the implementation. It might be used for rare conditions, such as operations that are difficult to implement in hardware, or operations that are gate intensive in hardware. This permits consistent software behavior with varying degrees of hardware support.

The division of labor between the hardware and software components of an implementation, and details of the interface between the support code and hardware are SUBARCHITECTURE DEFINED.

Asynchronous bounces, serialization, and VFP exception barriers

A VFP implementation can produce an *asynchronous bounce*, in which a VFP instruction takes the Undefined Instruction exception because support code processing is required for an earlier VFP instruction. The mechanism by which the nature of the required processing is communicated to the support code is SUBARCHITECTURE DEFINED. Typically, it involves:

- using the SUBARCHITECTURE DEFINED bits of the FPEXC, see *The Floating-Point Exception Register (FPEXC)* on page B1-68
- using the SUBARCHITECTURE DEFINED extension system registers, see *Advanced SIMD and VFP extension system registers* on page B1-66
- setting FPEXC.EX == 1, to indicate that the SUBARCHITECTURE DEFINED extension system registers must be saved on a context switch.

An asynchronous bounce might not relate to the last VFP instruction executed before the one that took the Undefined Instruction exception. It is possible that another VFP instruction has been issued and retired before the asynchronous bounce occurs. This is possible only if this intervening instruction has no register dependencies on the VFP instruction that requires support code processing. In addition, it is possible that there are SUBARCHITECTURE DEFINED mechanisms for handling an intervening VFP instruction that has issued but not retired.

However, VMRS and VMSR instructions that access the FPSID, FPSCR, or FPEXC registers are *serializing* instructions. This means they ensure that any exceptional condition in any preceding VFP instruction that requires support code processing has been detected and reflected in the extension system registers before they perform the register transfer. A VMSR instruction to the read-only FPSID register is a serializing NOP.

In addition:

- A VMRS or VMSR instruction that accesses the FPSCR acts as a *VFP exception barrier*. This means it ensures that any outstanding exceptional conditions in preceding VFP instructions have been detected and processed by the support code before it performs the register transfer. If necessary, the VMRS or VMSR instruction takes an asynchronous bounce to force the processing of outstanding exceptional conditions.
- VMRS and VMSR instructions that access the FPSID or FPEXC do not take asynchronous bounces.

VFP serialization and the VFP exception barriers are described in pseudocode by the `SerializeVFP()` and `VFPExcBarrier()` functions respectively:

```
SerializeVFP()
```

```
VFPExcBarrier()
```

Interactions with the ARM architecture

ARM recommends that a VFP extension uses the Undefined Instruction mechanism to invoke its support code, see *Undefined Instruction exceptions* on page B1-76. To do this:

1. Before enabling the extension hardware, install the support code on the Undefined Instruction vector.
2. If the extension hardware requires assistance from the support code, it does not respond to a VFP instruction.
3. This causes an Undefined Instruction exception, that causes the support code to be executed.

VFP load/store instructions can generate Data Abort exceptions, and therefore implementations must be able to cope with a Data Abort exception on any memory access caused by such instructions.

Interrupts

Taking the Undefined Instruction exception causes IRQs to be disabled, see *Undefined Instruction exception* on page B1-49. Normally, IRQs are not re-enabled until the exception handler returns. This means that normal use of a VFP extension that requires support code in a system can increase worst case IRQ latency considerably.

You can reduce this IRQ latency penalty considerably by explicitly re-enabling interrupts soon after entry to the Undefined Instruction handler. This requires careful integration of the Undefined Instruction handler into the rest of the operating system. How this might be done is highly system-specific and beyond the scope of this manual.

A system where the IRQ handler itself might use the VFP coprocessor has a second potential cause of increased IRQ latency. This increase occurs if a long latency VFP operation is initiated by the interrupted application program, denying the use of the extension hardware to the IRQ handler for a significant number of cycles.

Therefore, if a system contains IRQ handlers that require both low interrupt latency and the use of VFP instructions, ARM recommends that the use of the highest latency Advanced SIMD or VFP instructions is avoided.

———— **Note** —————

FIQs are not disabled by entry to the Undefined Instruction handler, and so FIQ latency is not affected by the use of the Undefined Instruction exception described here. However, because they are not disabled, an FIQ can occur at any point during support code execution, including during the entry and exit sequences of the Undefined Instruction handler. If an FIQ handler can make any change to the state of the Advanced SIMD or VFP implementation, you must take great care to ensure that it handles every case correctly. Usually, this requirement is incompatible with the requirement that FIQs provide fast interrupt processing. Therefore ARM recommends that FIQ handlers do not use the Advanced SIMD or VFP extension.

B1.8.6 VFP subarchitecture support

In the ARMv7 specification of the VFP extension, some features are identified as SUBARCHITECTURE DEFINED. ARMv7 is fully compatible with the *ARM Common VFP subarchitecture*, that ARM has used for several VFP implementations. However, ARMv7 does not require or specifically recommend the use of the ARM Common VFP subarchitecture.

Appendix B *Common VFP Subarchitecture Specification* is the specification of the *ARM Common VFP subarchitecture*. The subarchitecture is not part of the ARMv7 architecture specification. For details of the status of the subarchitecture specification see the *Note* on the cover page of Appendix B.

B1.9 Execution environment support

Support code for an execution environment can execute in two of the processor states described in *Instruction set states* on page B1-23:

- ThumbEE state supports the Thumb Execution Environment. For more information, see *Thumb Execution Environment*.
- Jazelle state supports direct bytecode execution. For more information, see *Jazelle direct bytecode execution* on page B1-74.

B1.9.1 Thumb Execution Environment

See *Thumb Execution Environment* on page A2-69 for an introduction to the *Thumb Execution Environment* (ThumbEE), including an application level view of the execution environment, and a definition of its CP14 registers. This section describes the system level programmers' model for ThumbEE. For more information about ThumbEE see Chapter A9 *ThumbEE*.

The ThumbEE Configuration Register can be read in User mode, but can be written only in privileged modes, see *ThumbEE Configuration Register (TEECR)* on page A2-70.

Access to the ThumbEE Handler Base Register depends on the value held in the TEECR and the current privilege level, see *ThumbEE Handler Base Register (TEEHBR)* on page A2-71.

The processor executes ThumbEE instructions when it is in ThumbEE state.

The processor instruction set state is indicated by the CPSR.J and CPSR.T bits, see *Program Status Registers (PSRs)* on page B1-14. (J,T) == 0b11 when the processor is in ThumbEE state.

During normal execution, not involving exception entries and returns:

- ThumbEE state can only be entered from Thumb state, using the ENTERX instruction
- exit from ThumbEE state always occurs using the LEAVEX instruction and returns execution to Thumb state.

For details of these instructions see *ENTERX, LEAVEX* on page A9-7.

When an exception occurs in ThumbEE state, exception entry goes to either ARM state or Thumb state as usual, depending on the value of SCTLR.TE. When the exception handler returns, the exception return instruction restores CPSR.J and CPSR.T as usual, causing a return to ThumbEE state.

In ThumbEE state, execution of the exception return instructions described in *Exception return* on page B1-38 is UNPREDICTABLE.

ThumbEE and the Security Extensions

When an implementation that supports ThumbEE includes the Security Extensions, the ThumbEE registers are not banked. If ThumbEE support is required in both Secure and Non-secure states, the monitor must save and restore the register contents accordingly.

Aborts, exceptions, and checks

Aborts and exceptions are unchanged in ThumbEE. A null check takes priority over an abort or watchpoint on the same memory access. For more information, see *Null checking* on page A9-3.

The IT state bits in the CPSR are always cleared on entry to a NullCheck or IndexCheck handler. For more information, see *IT block and check handlers* on page A9-5.

B1.9.2 Jazelle direct bytecode execution

In Jazelle state the processor executes bytecode programs, as described in *Jazelle state* on page A2-74.

The processor instruction set state is indicated by the CPSR.J and CPSR.T bits, see *Program Status Registers (PSRs)* on page B1-14. (J,T) == 0b10 when the processor is in Jazelle state. For more information about entering and leaving Jazelle state see *Jazelle state* on page B1-81.

Extension of the PC to 32 bits

To enable the PC to point to an arbitrary bytecode instruction, in a non-trivial Jazelle implementation all 32 bits of the PC are defined. In the PC, bit [0] always reads as zero when in ARM, Thumb, or ThumbEE state.

The existence of bit [0] in the PC is only visible in ARM, Thumb, or ThumbEE states when an exception occurs in Jazelle state and the exception return address is odd-byte aligned.

The main architectural implication of this is that an exception handler must ensure that it restores all 32 bits of the PC. The recommended ways of handling exception returns behave correctly.

Exception handling in the Jazelle extension

Exceptions on page B1-30 describes how exception entry occurs if an exception occurs while the processor is executing in Jazelle state. This section gives more information about how exceptions in Jazelle state are taken and handled.

Interrupts and Fast interrupts, IRQ and FIQ

To enable the standard mechanism for handling interrupts to work correctly, a Jazelle hardware implementation must ensure that one of the following applies at the point where execution of a bytecode instruction might be interrupted by an IRQ or FIQ:

- Execution has reached a bytecode instruction boundary. That is:
 - all operations required to implement one bytecode instruction have completed
 - no operations required to implement the next bytecode instruction has completed.

The LR value on entry to the interrupt handler must be (address of the next bytecode instruction) + 4.

- The sequence of operations performed from the start of execution of the current bytecode instruction, up to the point where the interrupt occurs, is idempotent. This means that the sequence can be repeated from its start without changing the overall result of executing the bytecode instruction.

The LR value on entry to the interrupt handler must be (address of the current bytecode instruction) + 4.

- Corrective action is taken either:
 - directly by the Jazelle extension hardware
 - indirectly, by calling a SUBARCHITECTURE DEFINED handler in the EJVM.

The corrective action must re-create a situation where the bytecode instruction can be re-executed from its start.

The LR value on entry to the interrupt handler must be (address of the interrupted bytecode instruction) + 4.

Data Abort exceptions

On taking a Data Abort exception, the value saved in LR_abt must ensure that the Data Abort handler can:

- read the CP15 Fault Status and Fault Address registers
- fix the reason for the abort
- return using SUBS PC,LR,#8 or its equivalent.

The abort handler must be able to do this without looking at the instruction that caused the abort or which instruction set state it was executed in. On an ARMv7-A implementation, the abort handler must take account of the virtual memory system.

Note

- This assumes that the intention is to return to and retry the bytecode instruction that caused the Data Abort exception. If the intention is instead to return to the bytecode instruction after the one that caused the abort, then the return address must be modified by the length of the bytecode instruction that caused the abort.
- For details of the CP15 Fault Status and Fault Address:
 - for a VMSA implementation, see *CP15 c5, Fault status registers* on page B3-121 and *CP15 c6, Fault Address registers* on page B3-124
 - for a PMSA implementation, see *CP15 c5, Fault status registers* on page B4-54 and *CP15 c6, Fault Address registers* on page B4-57.

To enable the standard mechanism for handling Data Abort exceptions to work correctly, a Jazelle hardware implementation must ensure that one of the following applies at any point where a bytecode instruction can generate a Data Abort exception:

- The sequence of operations performed from the start of execution of the bytecode instruction, up to the point where the Data Abort exception is generated, is idempotent. This means that the sequence can be repeated from its start without changing the overall result of executing the bytecode instruction.
- If the Data Abort exception is generated during execution of a bytecode instruction, corrective action is taken either:
 - directly by the Jazelle extension hardware

— indirectly, by calling a SUBARCHITECTURE DEFINED handler in the EJVM.

The corrective action must re-create a situation where the bytecode instruction can be re-executed from its start.

———— **Note** —————

From ARMv6, the ARM architecture does not support the Base Updated Abort Model. This removes a potential obstacle to the first of these solutions. For information about the Base Updated Abort Model in earlier versions of the ARM architecture see *The ARM abort model* on page AppxH-20.

Prefetch Abort exceptions

On taking a Prefetch Abort exception, the value saved in LR_abt must ensure that the Prefetch Abort handler can locate the start of the instruction that caused the abort simply and without looking at the instruction set state in which its execution was attempted. The start of this instruction is always at address (LR_abt – 4). On an ARMv7-A implementation, the abort handler must take account of the virtual memory system.

A multi-byte bytecode instruction can cross a page boundary. In this case the Prefetch Abort handler cannot use LR_abt to determine which of the two pages caused the abort. How this situation is handled is SUBARCHITECTURE DEFINED, but if it is handled by taking a Prefetch Abort exception, the architecture requires that (LR_abt – 4) must point to the first byte of the bytecode instruction that caused the abort.

To ensure subarchitecture-independence, OS designers must write Prefetch Abort handlers in such a way that they can handle a Prefetch Abort exception generated in either of the two pages spanned by a multi-byte bytecode instruction that crosses a page boundary. In an implementation that has an Instruction Fault Address Register (IFAR), the IFAR can be used to determine the faulting page. Otherwise, a simple technique is:

```
IF the page pointed to by (LR_abt – 4) is not mapped
  THEN map the page
  ELSE map the page following the page including (LR_abt – 4)
ENDIF
retry the instruction
```

SVC and SMC exceptions

SVC and SMC exceptions must not be taken during Jazelle state execution. To cause either of these exceptions to be taken, a Jazelle implementation must exit to a software handler that executes an SVC or SMC instruction.

Undefined Instruction exceptions

The Undefined Instruction exception must not be taken during Jazelle state execution, except on a trivial implementation of ~~Jazelle state as~~ described in *Exception return to an unsupported instruction set state* on page B1-40.

When executing in Jazelle state, the Jazelle extension hardware might use a coprocessor extension such as the VFP extension to execute some operations. If it does so, it must avoid taking Undefined Instruction exceptions while in Jazelle state, even if an exceptional condition occurs that would normally cause the coprocessor extension to generate an Undefined Instruction exception.

Jazelle state configuration and control

For details of the configuration and control of Jazelle state from the application level, see *Application level configuration and control of the Jazelle extension* on page A2-75. That section includes descriptions of the Jazelle extension registers that can be accessed from User mode:

- *Jazelle ID Register (JIDR)* on page A2-76
- *Jazelle Main Configuration Register (JMCR)* on page A2-77.

The other Jazelle extension register is accessible only from privileged modes, see *Jazelle OS Control Register (JOSCR)*. This register controls access to the Jazelle extension.

When the Security Extensions are implemented, the Jazelle registers are common to the Secure and Non-secure security states. Each register has the same access permissions in both security states. For more information, see the register descriptions.

Changes to the Jazelle CP14 registers have the same synchronization requirements as changes to the CP15 registers. These are described in:

- *Changes to CP15 registers and the memory order model* on page B3-77 for a VMSA implementation
- *Changes to CP15 registers and the memory order model* on page B4-28 for a PMSA implementation.

Note

- Normally, an EJVM never accesses the JOSCR.
- An EJVM that runs in User mode must not attempt to access the JOSCR.

Jazelle OS Control Register (JOSCR)

The Jazelle OS Control Register (JOSCR) provides operating system control of the use of the Jazelle extension by processes and threads.

The JOSCR is:

- a CP14 register
- a 32-bit read/write register
- accessible only from privileged modes
- when the Security Extensions are implemented, a Common register.

The format of the JOSCR is:

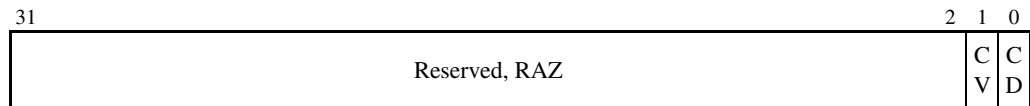

Bits [31:2] Reserved, RAZ. These bits are reserved for future expansion.

CV, bit [1] Configuration Valid bit. This bit is used by an operating system to signal to the EJVM that it must re-write its configuration to the configuration registers. The possible values are:

- 0** Configuration not valid. The EJVM must re-write its configuration to the configuration registers before it executes another bytecode instruction.

- 1** Configuration valid. The EJVM does not need to update the configuration registers.

When the JMCR.JE bit is set to 1, the CV bit also controls entry to Jazelle state, see *Controlling entry to Jazelle state* on page B1-79.

CD, bit [0] Configuration Disabled bit. This bit is used by an operating system to disable User mode access to the JIDR and configuration registers:

- 0** Configuration enabled. Access to the Jazelle registers, including User mode accesses, operate normally. For more information, see the register descriptions in *Application level configuration and control of the Jazelle extension* on page A2-75.
- 1** Configuration disabled in User mode. User mode access to the Jazelle registers are UNDEFINED, and all User mode accesses to the Jazelle registers cause an Undefined Instruction exception.

For more information about the use of this bit see *Monitoring and controlling User mode access to the Jazelle extension* on page B1-80.

The JOSCR provides a control mechanism that is independent of the subarchitecture of the Jazelle extension. An operating system can use this mechanism to control access to the Jazelle extension. Normally, this register is used in conjunction with the JMCR.JE bit, see *Jazelle Main Configuration Register (JMCR)* on page A2-77.

The JOSCR.CV and JOSCR.CD bits are both set to 0 on reset. This ensures that, subject to some conditions, an EJVM can operate under an OS that does not support the Jazelle extension. The main condition required to ensure an EJVM can operate under an OS that does not support the Jazelle extension is that the operating system never swaps between two EJVM processes that require different settings of the Jazelle configuration registers.

Two examples of how this condition can be met in a system are:

- if there is only ever one process or thread using the EJVM
- if all of the processes or threads that use the EJVM use the same static settings of the configuration registers.

Accessing the JOSCR

To access the JOSCR you read or write the CP14 registers with <opc1> set to 7, <CRn> set to c1, <CRm> set to c0, and <opc2> set to 0. For example:

```
MRC p14, 7, <Rt>, c1, c0, 0 ; Read Jazelle OS Control Register
MCR p14, 7, <Rt>, c1, c0, 0 ; Write Jazelle OS Control Register
```

———— Note ————

For maximum compatibility with any future enhancements to the Jazelle extension, ARM strongly recommends that a read, modify, write sequence is used to update the JOSCR. Updating the register in this way preserves the value of any of bits [31:2] that might be used by a future expansion.

Controlling entry to Jazelle state

The normal method of entering Jazelle state is using the BXJ instruction, see *Jazelle state entry instruction, BXJ* on page A2-74. The operation of this instruction depends on both:

- the value of the JMCR.JE bit, see *Jazelle Main Configuration Register (JMCR)* on page A2-77
- the value of the JOSCR.CV bit.

When the JMCR.JE bit is 0, the JOSCR has no effect on the execution of BXJ instructions. They always execute as BX instructions, and there is no attempt to enter Jazelle state.

When the JMCR.JE bit is 1, the JOSCR.CV bit controls the operation of BXJ instructions:

If CV == 1 The Jazelle extension hardware configuration is valid and enabled. A BXJ instruction causes the processor to enter Jazelle state in SUBARCHITECTURE DEFINED circumstances, and execute bytecode instructions as described in *Executing BXJ with Jazelle extension enabled* on page A2-75.

If CV == 0 The Jazelle extension hardware configuration is not valid and therefore entry to Jazelle state is disabled.

In all SUBARCHITECTURE DEFINED circumstances where, if CV had been 1 the BXJ instruction would have caused the Jazelle extension hardware to enter Jazelle state, it instead:

- enters a Configuration Invalid handler
- sets CV to 1.

A Configuration Invalid handler is a sequence of instructions that:

- includes MCR instructions to write the configuration required by the EJVM
- ends with a BXJ instruction to re-attempt execution of the required bytecode instruction.

The following are SUBARCHITECTURE DEFINED:

- how the address of the Configuration Invalid handler is determined
- the entry and exit conditions of the Configuration Invalid handler.

In circumstances in which the Jazelle extension hardware would not have entered Jazelle state if CV had been 1, it is IMPLEMENTATION DEFINED whether:

- the Configuration Invalid handler is entered
- a SUBARCHITECTURE DEFINED handler is entered, as described in *Executing BXJ with Jazelle extension enabled* on page A2-75.

In ARMv7, the JOSCVR.CV bit is set to 0 on exception entry for all implementations other than a trivial implementation of the Jazelle extension.

The intended use of the JOSCR.CV bit is:

1. When a context switch occurs, JOSCR.CV is set to 0. This is done by the operating system or, in ARMv7, as the result of an exception.

2. When the new process or thread performs a BXJ instruction to start executing bytecode instructions, the Configuration Invalid handler is entered and JOSCR.CV becomes 1.
3. The Configuration Invalid handler:
 - writes the configuration required by the EJVM to the Jazelle configuration registers
 - retries the BXJ instruction to execute the bytecode instruction.

This ensures that the Jazelle extension configuration registers are set up correctly for the EJVM concerned before any bytecode instructions are executed. It successfully handles cases where a context switch occurs during execution of the Configuration Invalid handler.

Monitoring and controlling User mode access to the Jazelle extension

The system can use the JOSCR.CD bit in different ways to monitor and control User mode access to the Jazelle extension hardware. Possible uses include:

- An OS can set JOSCR.CD == 1 and JMCR.JE == 0, to prevent all User mode access to the Jazelle extension hardware. With these settings any use of the BXJ instruction has the same result as a BX instruction, and any attempt to configure the hardware, including any attempt to set the JMCR.JE bit to 1, results in an Undefined Instruction exception.
- A simple mechanism for the OS to provide User mode access to the Jazelle extension hardware, while protecting EJVMs from conflicting use of the hardware by other processes, is:
 - Set the JOSCR.CD bit to 0.
 - Preserve and restore the JMCR on context switches, initializing its value to 0 for new processes.
 - The JOSCR.CV bit is set to 0 on each context switch, either by the operating system or, in ARMv7, as the result of an exception. This ensures that EJVMs reconfigure the Jazelle extension hardware to match their requirements when necessary.

The context switch mechanism is described in *Controlling entry to Jazelle state* on page B1-79.

EJVM operation

EJVM operation on page A2-79 described the architectural requirements for an EJVM at the application level. Because the EJVM is provided for use by applications, the system level description of the architecture does not require significant additional information about the EJVM.

Initialization on page A2-79 stated that, if the EJVM is compatible with the subarchitecture, the EJVM must write its required configuration to the JMCR and any other configuration registers. The EJVM must not omit this step on the assumption that the JOSCR.CV bit is 0. In other words, the EJVM must not assume that JOSCR.CV == 0, and that this will trigger entry to the Configuration Invalid handler before any bytecode instruction is executed by the Jazelle extension hardware.

Trivial implementation of the Jazelle extension

Jazelle direct bytecode execution support on page A2-73 introduced the possible trivial implementation of the Jazelle extension, and summarized the application level requirements of a trivial implementation. This section gives the system level description of a trivial implementation of the Jazelle extension.

A trivial implementation of the Jazelle extension must:

- Implement the JIDR with the implementer and subarchitecture fields set to zero. The register can be implemented so that the whole register is RAZ.
- Implement the JMCR as RAZ/WI.
- Implement the JOSCR either:
 - so that it can be read and written, but its effects are ignored
 - as RAZ/WI.

This enables operating systems that support an EJVM to execute correctly.

- Implement the BXJ instruction to behave identically to the BX instruction in all circumstances, as required by the fact that the JMCR.JE bit is always zero. This means that Jazelle state can never be entered normally on a trivial implementation.
- Treat Jazelle state as an unsupported instruction set state, as described in *Exception return to an unsupported instruction set state* on page B1-40.

A trivial implementation does not have to extend the PC to 32 bits, that is, it can implement PC[0] as RAZ/WI. This is because the only way that PC[0] is visible in ARM or Thumb state is as a result of a processor exception occurring during Jazelle state execution, and Jazelle state execution cannot occur on a trivial implementation.

Jazelle state

All processor configuration information that can be modified by Jazelle state execution must be kept in the Application Level registers described in *ARM processor modes and core registers* on page B1-6. This ensures that the processor configuration information is preserved and restored correctly when processor exceptions and context switches occur. Configuration information can be kept either in Application Level registers or in configuration registers. In this context, configuration information is information that affects Jazelle state execution but is not modified by it.

An *Enabled Java Virtual Machine* (EJVM) implementation must check whether the implemented Jazelle extension is compatible with its use of the Application Level registers. If the implementation is compatible, the EJVM sets JE == 1 in the JMCR, see *Jazelle Main Configuration Register (JMCR)* on page A2-77. If the implementation is not compatible, the EJVM sets JE == 0 and executes without hardware acceleration.

Jazelle state exit

The processor exits Jazelle state in IMPLEMENTATION DEFINED circumstances. Typically, this is due to attempted execution of a bytecode instruction that the implementation cannot handle in hardware, or that generates one of the Java exceptions described in Lindholm and Yellin, *The Java Virtual Machine Specification 2nd Edition*. On exit from Jazelle state, various processor registers contain SUBARCHITECTURE DEFINED values, enabling the EJVM to resume software execution of the bytecode program correctly.

The processor also exits Jazelle state when a processor exception occurs. The CPSR is copied to the banked SPSR for the exception mode, so the banked SPSR contains $J == 1$ and $T == 0$, and Jazelle state is restored on return from the exception when the SPSR is copied back into the CPSR. With the restriction that Jazelle state execution can modify only Application Level registers, this ensures that all registers are correctly preserved and can be restored by the exception handlers. Configuration and control registers can be modified in the exception handler itself as described in *Jazelle state configuration and control* on page B1-77 and *Jazelle OS Control Register (JOSCR)* on page B1-77.

Specific considerations apply to processor exceptions, see *Exception handling in the Jazelle extension* on page B1-74.

It is IMPLEMENTATION DEFINED whether Jazelle extension hardware contains state that is both:

- modified during Jazelle state execution
- held outside the Application Level registers during Jazelle state execution.

If such state exists, the implementation must:

- Initialize the state from one or more of the Application Level registers whenever Jazelle state is entered, whether as the result of:
 - the execution of a BXJ instruction
 - returning from a processor exception.
- Write the state into one or more of the Application Level registers whenever Jazelle state is exited, whether as a result of taking a processor exception or of IMPLEMENTATION DEFINED circumstances.
- Ensure that the mechanism for writing the state into Application Level registers on taking a processor exception, and initializing the state from Application Level registers on returning from that exception, ensures that the state is correctly preserved and restored over the exception.

Additional Jazelle state restrictions

The Jazelle extension hardware must obey the following restrictions:

- It must not change processor mode other than by taking one of the standard ARM processor exceptions.
- It must not access banked versions of registers other than the ones belonging to the processor mode in which it is entered.
- It must not do anything that is illegal for an UNPREDICTABLE instruction. That is, it must not:
 - generate a security loophole
 - halt or hang the processor or any other part of the system.

As a result of these requirements, Jazelle state can be entered from User mode without risking a breach of OS security.

In addition, Jazelle state execution is UNPREDICTABLE in FIQ mode.

Chapter B2

Common Memory System Architecture Features

This chapter provides a system-level view of the general features of the memory system. It contains the following sections:

- *About the memory system architecture* on page B2-2
- *Caches* on page B2-3
- *Implementation defined memory system features* on page B2-27
- *Pseudocode details of general memory system operations* on page B2-29.

B2.1 About the memory system architecture

The ARM architecture supports different implementation choices for the memory system microarchitecture and memory hierarchy, depending on the requirements of the system being implemented. In this respect, the memory system architecture describes a design space in which an implementation is made. The architecture does not prescribe a particular form for the memory systems. Key concepts are abstracted in a way that enables implementation choices to be made while enabling the development of common software routines that do not have to be specific to a particular microarchitectural form of the memory system. For more information about the concept of a hierarchical memory system see *Memory hierarchy* on page A3-52.

B2.1.1 Form of the memory system architecture

ARMv7 supports different forms of the memory system architecture, that map onto the different architecture profiles. Two of these are described in this manual:

- ARMv7-A, the A profile, requires the inclusion of a *Virtual Memory System Architecture (VMSA)*, as described in Chapter B3 *Virtual Memory System Architecture (VMSA)*.
- ARMv7-R, the R profile, requires the inclusion of a *Protected Memory System Architecture (PMSA)*, as described in Chapter B4 *Protected Memory System Architecture (PMSA)*.

Both of these memory system architectures provide mechanisms to split memory into different regions. Each region has specific memory types and attributes. The two memory system architectures have different capabilities and programmers' models.

The memory system architecture model required by ARMv7-M, the M profile, is outside the scope of this manual. It is described in the *ARMv7-M Architecture Reference Manual*.

B2.1.2 Memory attributes

Summary of ARMv7 memory attributes on page A3-25 summarizes the memory attributes, including how different memory types have different attributes. Each region of memory has a set of memory attributes:

- in a PMSA implementation the attributes are part of each MPU memory region definition
- in a VMSA implementation the translation table entry that defines a virtual memory region also defines the attributes for that region.

B2.1.3 Levels of cache

From ARMv7, the architecturally-defined cache control mechanism covers multiple levels of cache, as described in *Caches* on page B2-3. Also, it permits levels of cache beyond the scope of these cache control mechanisms, see *System-level caches* on page B2-26.

———— **Note** —————

Before ARMv7, the architecturally-defined cache control mechanism covers only a single level of cache, and any support for other levels of cache is IMPLEMENTATION DEFINED.

B2.2 Caches

The concept of caches is described in *Caches and memory hierarchy* on page A3-51. This section describes the cache identification and control mechanisms in ARMv7. These are described in the following sections:

- *Cache identification*
- *Cache behavior* on page B2-5
- *Cache enabling and disabling* on page B2-8
- *Cache maintenance functionality* on page B2-9
- *The interaction of cache lockdown with cache maintenance* on page B2-18
- *Branch predictors* on page B2-19
- *Ordering of cache and branch predictor maintenance operations* on page B2-21
- *Multiprocessor effects on cache maintenance operations* on page B2-23
- *System-level caches* on page B2-26.

Note

The cache identification and control mechanisms for previous versions of the ARM architecture are described in:

- *Cache support* on page AppxG-21, for ARMv6
 - *Cache support* on page AppxH-21, for the ARMv4 and ARMv5 architectures.
-

B2.2.1 Cache identification

The ARMv7 cache identification consists of a set of registers that describe the implemented caches that are under the control of the processor:

- A single Cache Type Register defines:
 - the minimum line length of any of the instruction caches
 - the minimum line length of any of the data or unified caches
 - the cache indexing and tagging policy of the Level 1 instruction cache.
 For more information, see:
 - *c0, Cache Type Register (CTR)* on page B3-83, for a VMSA implementation
 - *c0, Cache Type Register (CTR)* on page B4-34, for a PMSA implementation.
- A single Cache Level ID Register defines:
 - the type of cache implemented at a each cache level, up to the maximum of seven levels
 - the Level of Coherence for the caches
 - the Level of Unification for the caches.

For more information, see:

- *c0, Cache Level ID Register (CLIDR)* on page B3-92, for a VMSA implementation
- *c0, Cache Level ID Register (CLIDR)* on page B4-41, for a PMSA implementation.

- A single Cache Size Selection Register selects the cache level and cache type of the current Cache Size Identification Register, see:
 - *c0*, Cache Size Selection Register (CSSELR) on page B3-95, for a VMSA implementation
 - *c0*, Cache Size Selection Register (CSSELR) on page B4-43, for a PMSA implementation.
 - For each implemented cache, across all the levels of caching, a Cache Size Identification Register defines:
 - whether the cache supports Write-Through, Write-Back, Read-Allocate and Write-Allocate
 - the number of sets, associativity and line size of the cache.
- For more information, see:
- *c0*, Cache Size ID Registers (CCSIDR) on page B3-91, for a VMSA implementation
 - *c0*, Cache Size ID Registers (CCSIDR) on page B4-40, for a PMSA implementation.

Identifying the cache resources in ARMv7

From ARMv7 the architecture defines support for multiple levels of cache, up to a maximum of seven levels. This means the process of identifying the cache resources available to the processor in an ARMv7 implementation is more complicated. To obtain this information:

1. Read the Cache Type Register to find the indexing and tagging policy used for the Level 1 instruction cache. This register also provides the size of the smallest cache lines used for the instruction caches, and for the data and unified caches. These values are used in cache maintenance operations.
2. Read the Cache Level ID Register to find what caches are implemented. The register includes seven Cache type fields, for cache levels 1 to 8. Scanning these fields, starting from Level 1, identifies the instruction, data or unified caches implemented at each level. This scan ends when it reaches a level at which no caches are defined. The Cache Level ID Register also provides the Level of Unification and the Level of Coherency for the cache implementation.
3. For each cache identified at stage 2:
 - Write to the Cache Size Selection Register to select the required cache. A cache is identified by its level, and whether it is:
 - an instruction cache
 - a data or unified cache.
 - Read the Cache Size ID Register to find details of the cache.

Note

In ARMv6, only the Level 1 caches are architecturally defined, and the Cache Type Register holds details of the caches. For more information, see *Cache support* on page AppxG-21.

B2.2.2 Cache behavior

The behavior of caches in an ARMv7 implementation is summarized in the following subsections:

- *General behavior of the caches*
- *Behavior of the caches at reset* on page B2-6
- *Behavior of Preload Data (PLD, PLDW) and Preload Instruction (PLI) with caches* on page B2-7.

General behavior of the caches

When a memory location is marked with a Normal Cacheable memory attribute, determining whether a copy of the memory location is held in a cache still depends on many aspects of the implementation. Typically, the following non-exhaustive list of factors might be involved:

- the size, line-length, and associativity of the cache
- the cache allocation algorithm
- activity by other elements of the system that can access the memory
- instruction prefetching algorithms
- data prefetching algorithms
- interrupt behaviors.

Given this range of factors, and the large variety of cache systems that might be implemented, the architecture cannot guarantee whether:

- a memory location present in the cache remains in the cache
- a memory location not present in the cache is brought into the cache.

Instead, the following principles apply to the behavior of caches:

- The architecture has a concept of an entry locked down in the cache. How lockdown is achieved is IMPLEMENTATION DEFINED, and lockdown might not be supported by:
 - a particular implementation
 - some memory attributes.
- An unlocked entry in the cache cannot be relied upon to remain in the cache. If an unlocked entry does remain in the cache, it cannot be relied upon to remain incoherent with the rest of memory. In other words, software must not assume that an unlocked item that remains in the cache remains dirty.
- A locked entry in the cache can be relied upon to remain in the cache. A locked entry in the cache cannot be relied upon to remain incoherent with the rest of memory, that is, it cannot be relied upon to remain dirty.

———— **Note** —————

For more information, see *The interaction of cache lockdown with cache maintenance* on page B2-18.

- If a memory location is marked as Cacheable there is no mechanism by which it can be guaranteed not to be allocated to an enabled cache at any time. Any application must assume that any Cacheable memory location can be allocated to any enabled cache at any time.

- If the cache is disabled, it is guaranteed that no new allocation of memory locations into the cache will occur.
- If the cache is enabled, it is guaranteed that no memory location that does not have a Cacheable attribute is allocated into the cache.
- If the cache is enabled, it is guaranteed that no memory location is allocated to the cache if its translation table attributes or region attributes prevent privileged read access.
- Any memory location that is marked as Normal Shareable is guaranteed to be coherent with all masters in that shareability domain for data accesses.
- Any memory location is not guaranteed to remain incoherent with the rest of memory.
- The eviction of a cache entry from a cache level can overwrite memory that has been written by another observer only if the entry contains a memory location that has been written to by a processor that controls that cache. The maximum size of the memory that can be overwritten is called the *Cache Writeback Granule*. In some implementations the CTR identifies the Cache Writeback Granule, see:
 - *c0*, *Cache Type Register (CTR)* on page B3-83 for a VMSA implementation
 - *c0*, *Cache Type Register (CTR)* on page B4-34 for a PMSA implementation.
- The allocation of a memory location into a cache cannot cause the most recent value of that memory location to become invisible to an observer, if it had previously been visible to that observer.

For the purpose of these principles, a cache entry covers at least 16 bytes and no more than 2KB of contiguous address space, aligned to its size.

In addition, in ARMv7, in the following situations it is UNPREDICTABLE whether the location is returned from cache or from memory:

- The location is not marked as Cacheable but is contained in the cache. This situation can occur if a location is marked as Non-cacheable after it has been allocated into the cache.
- The location is marked as Cacheable and might be contained in the cache, but the cache is disabled.

Behavior of the caches at reset

In ARMv7:

- All caches are disabled at reset.
- An implementation can require the use of a specific cache initialization routine to invalidate its storage array before it is enabled. The exact form of any required initialization routine is IMPLEMENTATION DEFINED, but the routine must be documented clearly as part of the documentation of the device.
- It is IMPLEMENTATION DEFINED whether an access can generate a cache hit when the cache is disabled. If an implementation permits cache hits when the cache is disabled the cache initialization routine must:
 - provide a mechanism to ensure the correct initialization of the caches
 - be documented clearly as part of the documentation of the device.

In particular, if an implementation permits cache hits when the cache is disabled and the cache contents are not invalidated at reset, the initialization routine must avoid any possibility of running from an uninitialized cache. It is acceptable for an initialization routine to require a fixed instruction sequence to be placed in a restricted range of memory.

- ARM recommends that whenever an invalidation routine is required, it is based on the ARMv7 cache maintenance operations.

When they are enabled the state of the caches is UNPREDICTABLE if the appropriate initialization routine has not been performed.

Similar rules apply:

- to branch predictor behavior, see *Behavior of the branch predictors at reset* on page B2-21
- on an ARMv7-A implementation, to TLB behavior, see *TLB behavior at reset* on page B3-55.

Note

Before ARMv7, caches are invalidated by the assertion of reset, see *Cache behavior at reset* on page AppxG-23.

Behavior of Preload Data (PLD, PLDW) and Preload Instruction (PLI) with caches

Preload Data and Preload Instruction operations are provided by the PLD and PLI instructions. These are implemented in the ARM and Thumb instruction sets. The Multiprocessing Extensions add the PLDW instruction.

PLD, PLDW and PLI act as hints to the memory system, and as such their operation does not cause a precise abort to occur. However, a memory operation performed as a result of one of these memory system hints might trigger an asynchronous event, so influencing the execution of the processor. Examples of the asynchronous events that might be triggered are asynchronous aborts and interrupts.

A PLD or PLDW instruction is guaranteed not to cause any effect to the caches, or TLB, or memory other than the effects that, for permission or other reasons, the equivalent load from the same location with the same context and at the same privilege level can cause.

A PLD or PLDW instruction is guaranteed not to access Strongly-ordered or Device memory.

A PLI instruction is guaranteed not to cause any effect to the caches, or TLB, or memory other than the effects that, for permission or other reasons, the fetch resulting from changing the PC to the location specified by the PLI instruction with the same context and at the same privilege level can cause.

A PLI instruction is guaranteed not to access Strongly-ordered or Device memory. In a VMSA implementation, a PLI instruction must not perform any accesses when the MMU is disabled.

Note

In ARMv6, an instruction prefetch is provided by the optional Prefetch instruction cache line operation in CP15 c7, with encoding <opc1> == 0, <CRm> == c13, <opc2> == 1, see *c7, Cache operations* on page AppxG-38.

Cache lockdown

Cache lockdown requirements can conflict with the management of hardware coherency. For this reason, ARMv7 introduces significant changes in this area, compared to previous versions of the ARM architecture. These changes recognize that, in many systems, cache lockdown is inappropriate.

For an ARMv7 implementation:

- There is no requirement to support cache lockdown.
- If cache lockdown is supported, the lockdown mechanism is IMPLEMENTATION DEFINED. However key properties of the interaction of lockdown with the architecture must be described in the implementation documentation.
- The Cache Type Register does not hold information about lockdown. This is a change from ARMv6. However some CP15 c9 encodings are available for IMPLEMENTATION DEFINED, cache lockdown features, see *Implementation defined memory system features* on page B2-27.

Note

For details of cache lockdown in ARMv6 see *c9, Cache lockdown support* on page AppxG-45.

B2.2.3 Cache enabling and disabling

Levels of cache on page B2-2 indicates that:

- from ARMv7 the architecture defines the control of multiple levels of cache
- before ARMv7 the architecture defines the control of only one level of cache.

This means the mechanism for cache enabling and disabling caches changes in ARMv7. In both cases, enabling and disabling of caches is controlled by the SCTL.R.C and SCTL.R.I bits, see:

- *c1, System Control Register (SCTLR)* on page B3-96, for a VMSA implementation
- *c1, System Control Register (SCTLR)* on page B4-45, for a PMSA implementation.

In ARMv7:

- The SCTL.R.C bit enables or disables all data and unified caches, across all levels of cache visible to the processor.
- The SCTL.R.I bit enables or disables all instruction caches, across all levels of cache visible to the processor.
- If an implementation requires finer-grained control of cache enabling it can implement control bits in the Auxiliary Control Register for this purpose. For example, an implementation might define control bits to enable and disable the caches at a particular level. For more information about the Auxiliary Control Register see:
 - *c1, Implementation defined Auxiliary Control Register (ACTLR)* on page B3-103, for a VMSA implementation
 - *c1, Implementation defined Auxiliary Control Register (ACTLR)* on page B4-50, for a PMSA implementation.

Note

In ARMv6, the SCTLR I, C, and W bits provide separate enables for the level 1 instruction cache (if implemented), the level 1 data or unified cache, and write buffering. For more information, see *c1, System Control Register (SCTLR)* on page AppxG-34.

When a cache is disabled:

- it is IMPLEMENTATION DEFINED whether a cache hit occurs if a location that is held in the cache is accessed
- any location that is not held in the cache is not brought into the cache as a result of a memory access.

The SCTLR.C and SCTLR.I bits describe the enabling of the caches, and do not affect the memory attributes generated by an enabled MMU or MPU.

If the MMU or MPU is disabled, the effects of the SCTLR.C and SCTLR.I bits on the memory attributes are described in:

- *Enabling and disabling the MMU* on page B3-5 for the MMU
- *Behavior when the MPU is disabled* on page B4-5 for the MPU.

B2.2.4 Cache maintenance functionality

ARMv7 redefines the required CP15 cache maintenance operations. The two main features of this change are:

- improved support for multiple levels of cache, including abstracting how many levels of cache are implemented.
- reducing the architecturally-defined set of operations to the minimum set required for operating systems

This section only describes cache maintenance for ARMv7. For details of cache maintenance in previous versions of the ARM architecture see:

- *c7, Cache operations* on page AppxG-38 for ARMv6
- *c7, Cache operations* on page AppxH-49 for the ARMv4 and ARMv5 architectures.

Terms used in describing cache operations on page B2-10 describes the terms used in this section. Then the following subsections describe the ARMv7 cache maintenance functionality:

- *ARMv7 cache maintenance operations* on page B2-13
- *The ARMv7 abstraction of the cache hierarchy* on page B2-15.

Terms used in describing cache operations

This section describes particular terms used in the descriptions of cache maintenance operations.

Cache maintenance operations are defined to act on particular memory locations. Operations can be defined:

- by the address of the memory location to be maintained, referred to as by MVA
- by a mechanism that describes the location in the hardware of the cache, referred to as by set/way.

In addition, the instruction cache invalidate operation has an option that invalidates all entries in the instruction caches.

The following subsections define the terms used to describe the cache operations:

- *Operations by MVA*
- *Operations by set/way*
- *Clean, Invalidate, and Clean and Invalidate* on page B2-11.

Operations by MVA

For cache operations by MVA, these terms relate to memory addressing, and in particular the relation between:

- *Modified Virtual Address (MVA)*
- *Virtual Address (VA)*
- *Physical Address (PA)*.

The term *Modified Virtual Address* relates to the *Fast Context Switch Extension (FCSE)* mechanism, described in Appendix E *Fast Context Switch Extension (FCSE)*. Use of the FCSE is deprecated in ARMv6 and the FCSE is optional in ARMv7. When the FCSE is absent or disabled, the MVA and VA have the same value. However the term MVA is used throughout this section, and elsewhere in this manual, for cache and TLB operations. This is consistent with previous issues of the *ARM Architecture Reference Manual*.

Virtual addresses only exist in systems with a MMU. When no MMU is implemented or the MMU is disabled, the MVA and VA are identical to the PA.

In the cache operations, any operation described as operating by MVA includes as part of any required MVA to PA translation:

- the current system *Application Space Identifier (ASID)*
- the current security state, if the Security Extensions are implemented.

Operations by set/way

Cache maintenance operations by set/way refer to the particular structures in a cache. Three parameters describe the location in a cache hierarchy that an operation works on. These parameters are:

- Level** The cache *level* of the hierarchy. The number of levels of cache is IMPLEMENTATION DEFINED, and can be determined from the Cache Level ID Register, see:
- *c0, Cache Level ID Register (CLIDR)* on page B3-92 for a VMSA implementation
 - *c0, Cache Level ID Register (CLIDR)* on page B4-41 for a PMSA implementation.

In the ARM architecture, the lower numbered levels are those closest to the processor, see *Memory hierarchy* on page A3-52.

Set Each level of a cache is split up into a number of *sets*. Each set is a set of locations in a cache level that an address can be assigned to. Usually, the set number is an IMPLEMENTATION DEFINED function of an address.

In the ARM architecture, sets are numbered from 0.

Way The *Associativity* of a cache defines the number of locations in a set that an address can be assigned to. The *way* number specifies a location in a set. In the ARM architecture, ways are numbered from 0.

Cache maintenance operations that work by set/way use the level, set and way values to determine the location acted on by the operation. The address in memory that corresponds to this cache location is determined by the cache.

———— **Note** —————

Because the allocation of a memory address to a cache location is entirely IMPLEMENTATION DEFINED, ARM expects that most portable code will use only the set/way operations as single steps in a routine to perform maintenance on the entire cache.

Clean, Invalidate, and Clean and Invalidate

Caches introduce coherency problems in two possible directions:

1. An update to a memory location by a processor that accesses a cache might not be visible to other observers that can access memory. This can occur because new updates are still in the cache and are not visible yet to the other observers that do not access that cache.
2. Updates to memory locations by other observers that can access memory might not be visible to a processor that accesses a cache. This can occur when the cache contains an old, or *stale*, copy of the memory location that has been updated.

The *Clean* and *Invalidate* operations address these two issues. The definitions of these operations are:

Clean A cache clean operation ensures that updates made by an observer that controls the cache are made visible to other observers that can access memory at the point to which the operation is performed. Once the Clean has completed, the new memory values are guaranteed to be visible to the point to which the operation is performed, for example to the point of unification.

The cleaning of a cache entry from a cache can overwrite memory that has been written by another observer only if the entry contains a location that has been written to by a processor that controls that cache.

Invalidate A cache invalidate operation ensures that updates made visible by observers that access memory at the point to which the invalidate is defined are made visible to an observer that controls the cache. This might result in the loss of updates to the locations affected by the invalidate operation that have been written by observers that access the cache.

If the address of an entry on which the invalidate operates does not have a Normal Cacheable attribute, or if the cache is disabled, then an invalidate operation also ensures that this address is not present in the cache.

————— **Note** —————

Entries for addresses with a Normal Cacheable attribute can be allocated to an enabled cache at any time, and so the cache invalidate operation cannot ensure that the address is not present in the cache.

—————

Clean and Invalidate

A cache *clean and invalidate* operation behaves as the execution of a clean operation followed immediately by an invalidate operation. Both operations are performed to the same location.

The points to which a cache maintenance operation can be defined differ depending on whether the operation is by MVA or by set/way:

- For set/way operations, and for *All* (entire cache) operations, the point is defined to be to the next level of caching.
- For MVA operations, two conceptual points are defined:

Point of coherency (POC)

For a particular MVA, the POC is the point at which all agents that can access memory are guaranteed to see the same copy of a memory location. In many cases, this is effectively the main system memory, although the architecture does not prohibit the implementation of caches beyond the POC that have no effect on the coherence between memory system agents.

Point of unification (POU)

The PoU for a processor is the point by which the instruction and data caches and the translation table walks of that processor are guaranteed to see the same copy of a memory location. In many cases, the point of unification is the point in a uniprocessor memory system by which the instruction and data caches and the translation table walks have merged.

The PoU for an Inner Shareable shareability domain is the point by which the instruction and data caches and the translation table walks of all the processors in that Inner Shareable shareability domain are guaranteed to see the same copy of a memory location. Defining this point permits self-modifying code to ensure future instruction fetches are associated with the modified version of the code by using the standard correctness policy of:

1. clean data cache entry by address
2. invalidate instruction cache entry by address.

The PoU also enables a uniprocessor system which does not implement the Multiprocessing Extensions to use the clean data cache entry operation to ensure that all writes to the translation tables are visible to the translation table walk hardware.

Three field definitions in the Cache Level ID Register relate to these conceptual points:

Level of Coherence

The level of coherence field defines the first level of cache that does not have to be cleaned or invalidated when cleaning or invalidating to the point of coherency. The value in the register is one less than the cache level, so a value of 0 indicates level 1 cache. For example, if the level of coherence field contains the value 3:

- level 4 cache is the first level that does not have to be cleaned or invalidated
- therefore, a clean to the point of coherency operation requires the level 1, level 2 and level 3 caches to be cleaned.

The specified level of coherence can be a level that is not implemented, indicating that all implemented caches are before the point of coherency.

Level of Unification Uniprocessor

The Level of Unification Uniprocessor field defines the first level of cache that does not have to be cleaned or invalidated when cleaning or invalidating to the point of unification for the processor. As with the Level of Coherence, the value in the register is one less than the cache level, so a value of 0 indicates Level 1 cache.

The specified Level of Unification Uniprocessor can be a level that is not implemented, indicating that all implemented caches are before the point of unification.

Level of Unification Inner Shareable

The Level of Unification Inner Shareable field defines the first level of cache that does not have to be cleaned or invalidated when cleaning or invalidating to the point of unification for the Inner Shareable shareability domain. As with the Level of Coherence, the value in the register is one less than the cache level, that means a value of 0 indicates Level 1 cache.

The specified Level of Unification Inner Shareable can be a level that is not implemented, indicating that all implemented caches are before the point of unification.

The Level of Unification Inner Shareable field is RAZ in implementations that do not implement the Multiprocessing Extensions.

For more information, see:

- *c0, Cache Level ID Register (CLIDR)* on page B3-92 for a VMSA implementation
- *c0, Cache Level ID Register (CLIDR)* on page B4-41 for a PMSA implementation.

ARMv7 cache maintenance operations

Cache maintenance operations are performed using accesses to CP15 c7. The operations are described in:

- *CP15 c7, Cache and branch predictor maintenance functions* on page B3-126, for a VMSA implementation
- *CP15 c7, Cache and branch predictor maintenance functions* on page B4-68, for a PMSA implementation.

This operations required by ARMv7 are:

Data cache and unified cache line operations

Any of these operations can be applied to

- any data cache
- any unified cache.

The supported operations are:

Invalidate by MVA

Performs an invalidate of a data or unified cache line based on the address it contains.

Invalidate by set/way

Performs an invalidate of a data or unified cache line based on its location in the cache hierarchy.

Clean by MVA

Performs a clean of a data or unified cache line based on the address it contains.

Clean by set/way

Performs a clean of a data or unified cache line based on its location in the cache hierarchy.

Clean and Invalidate by MVA

Performs a clean and invalidate of a data or unified cache line based on the address it contains.

Clean and Invalidate by set/way

Performs a clean and invalidate of a data or unified cache line based on its location in the cache hierarchy.

Instruction cache operations

Invalidate by MVA

Performs an invalidate of an instruction cache line based on the address it contains.

Invalidate All

Performs an invalidate of the entire instruction cache or caches, and of all Branch Prediction caches.

Note

Other cache maintenance operations specified in ARMv6 are not supported in ARMv7. Their associated encodings in CP15 c7 are UNPREDICTABLE.

An ARMv7 implementation can add additional IMPLEMENTATION DEFINED cache maintenance functionality using CP15 c15 operations, if this is required.

The ARMv7 specification of the cache maintenance operation describe what they are guaranteed to do in a system. It does not limit other behaviors that might occur, provided they are consistent with the requirements for cache behavior described in *Cache behavior* on page B2-5.

This means that as a side-effect of a cache maintenance operation:

- any location in the cache might be cleaned
- any unlocked location in the cache might be cleaned and invalidated.

Note

ARM recommends that, for best performance, such side-effects are kept to a minimum. In particular, when the Security Extensions are implemented ARM strongly recommends that the side-effects of operations performed in Non-secure state do not have a significant performance impact on execution in Secure state.

Effect of the Security Extensions on the cache maintenance operations

When the Security Extensions are implemented, each security state has its own physical address space. For details of how this affects the cache maintenance operations see *The effect of the Security Extensions on the cache operations* on page B3-27.

The ARMv7 abstraction of the cache hierarchy

The following subsections describe the ARMv7 abstraction of the cache hierarchy:

- *Cache hierarchy abstraction for address-based operations*
- *Cache hierarchy abstraction for set/way-based operations* on page B2-16.

Example code for cache maintenance operations on page B2-16 gives an example of cache maintenance code, that can be adapted for other cache operations, and *Boundary conditions for cache maintenance operations* on page B2-17 gives more information about the cache operations.

Cache hierarchy abstraction for address-based operations

The addressed-based cache operations are described as operating by MVA. Each of these operations is always qualified as being one of:

- performed to the point of coherency
- performed to the point of unification.

See *Terms used in describing cache operations* on page B2-10 for definitions of point of coherency and point of unification, and more information about possible meanings of MVA.

This means that the full list of possible address-based cache operations is:

- Invalidate data cache or unified cache line by MVA to the point of coherency
- Clean data cache or unified cache line by MVA to the point of coherency
- Clean data cache or unified cache line by MVA to the point of unification
- Clean and invalidate data cache or unified cache line by MVA to the point of coherency
- Invalidate instruction cache line by MVA to the point of unification.

The Cache Type Register holds minimum line length values for:

- the instruction caches
- the data and unified caches.

~~These values enable a range of addresses to be invalidated in an efficient manner.~~ For details of the register see:

- *c0, Cache Type Register (CTR)* on page B3-83 for a VMSA implementation
- *c0, Cache Type Register (CTR)* on page B4-34 for a PMSA implementation.

For details of the CP15 *c7* encodings for all cache maintenance operations see:

- *CP15 c7, Cache and branch predictor maintenance functions* on page B3-126 for a VMSA implementation
- *CP15 c7, Cache and branch predictor maintenance functions* on page B4-68 for a PMSA implementation.

Cache hierarchy abstraction for set/way-based operations

The set/way-based cache maintenance operations are:

- Invalidate data cache or unified cache line by set/way
- Clean data cache or unified cache line by set/way
- Clean and invalidate data cache or unified cache line by set/way

The CP15 *c7* encodings of these operations include a field that must be used to specify the cache level for the operation:

- a clean operation cleans from the level of cache specified through to at least the next level of cache, moving further from the processor
- an invalidate operation invalidates only at the level specified.

In addition to these set/way operations, a cache operation is provided for instruction cache maintenance, to Invalidate all instruction cache lines to the point of unification.

For details of the CP15 *c7* encodings for all cache maintenance operations see:

- *CP15 c7, Cache and branch predictor maintenance functions* on page B3-126 for a VMSA implementation
- *CP15 c7, Cache and branch predictor maintenance functions* on page B4-68 for a PMSA implementation.

Example code for cache maintenance operations

This code sequence illustrates a generic mechanism for cleaning the entire data or unified cache to the point of coherency:

```

MRC p15, 1, R0, c0, c0, 1      ; Read CLIDR
ANDS R3, R0, #&7000000
MOV R3, R3, LSR #23           ; Cache level value (naturally aligned)
BEQ Finished
MOV R10, #0

```



```

Loop1  ADD R2, R10, R10, LSR #1      ; Work out 3xcacheLevel
      MOV R1, R0, LSR R2          ; bottom 3 bits are the Cache type for this level
      AND R1, R1, #7              ; get those 3 bits alone
      CMP R1, #2
      BLT Skip                    ; no cache or only instruction cache at this level
      MCR p15, 2, R10, c0, c0, 0  ; write the Cache Size selection register
      ISB                         ; ISB to sync the change to the CacheSizeID reg
      MRC p15, 1, R1, c0, c0, 0   ; reads current Cache Size ID register
      AND R2, R1, #&7            ; extract the line length field
      ADD R2, R2, #4              ; add 4 for the line length offset (log2 16 bytes)
      LDR R4, =0x3FF
      ANDS R4, R4, R1, LSR #3     ; R4 is the max number on the way size (right aligned)
      CLZ R5, R4                  ; R5 is the bit position of the way size increment
      LDR R7, =0x00007FFF
      ANDS R7, R7, R1, LSR #13    ; R7 is the max number of the index size (right aligned)
Loop2  MOV R9, R4                  ; R9 working copy of the max way size (right aligned)
Loop3  ORR R11, R10, R9, LSL R5   ; factor in the way number and cache number into R11
      ORR R11, R11, R7, LSL R2   ; factor in the index number
      MCR p15, 0, R11, c7, c10, 2 ; clean by set/way
      SUBS R9, R9, #1            ; decrement the way number
      BGE Loop3
      SUBS R7, R7, #1            ; decrement the index
      BGE Loop2
Skip   ADD R10, R10, #2           ; increment the cache number
      CMP R3, R10
      BGT Loop1
Finished

```

Similar approaches can be used for all cache maintenance operations.

Boundary conditions for cache maintenance operations

Cache maintenance operations operate on the caches when the caches are enabled or when they are disabled.

For the address-based cache maintenance operations, the operations operate on the caches regardless of the memory type and cacheability attributes marked for the memory address in the VMSA translation table entries or in the PMSA section attributes. This means that the cache operations take no account of:

- whether the address accessed:
 - is Strongly-ordered, Device or Normal memory
 - has a Cacheable attribute or the Non-cacheable attribute
- the domain control of the address accessed
- the access permissions for the address accessed.

Therefore, software can:

- ensure there are no more allocations to the caches of a range of addresses because of prefetching effects or interrupts
- at the same time, continue to perform cache maintenance operations on these addresses.

In a VMSA implementation, some cache maintenance operations can generate an MMU fault, see *MMU faults* on page B3-40.

B2.2.5 The interaction of cache lockdown with cache maintenance

The interaction of cache lockdown and cache maintenance operations is IMPLEMENTATION DEFINED. However, an architecturally-defined cache maintenance operation on a locked cache line must comply with the following general rules:

- The effect of these operations on locked cache entries is IMPLEMENTATION DEFINED:
 - cache clean by set/way
 - cache invalidate by set/way
 - cache clean and invalidate by set/way
 - instruction cache invalidate all.

However, one of the following approaches must be adopted in all these cases:

1. If the operation specified an invalidation a locked entry is not invalidated from the cache. If the operation specified a clean it is IMPLEMENTATION DEFINED whether locked entries are cleaned.
2. If an entry is locked down, or could be locked down, an IMPLEMENTATION DEFINED Data Abort exception is generated, using the fault status code defined for this purpose in CP15 c5, see either:
 - *Fault Status and Fault Address registers in a VMSA implementation* on page B3-48
 - *Fault Status and Fault Address registers in a PMSA implementation* on page B4-18.

This permits a typical usage model for cache invalidate routines to operate on a large range of addresses by performing the required operation on the entire cache, without having to consider whether any cache entries are locked. The operation performed is either an invalidate, or a clean and invalidate.

- The effect of these operations is IMPLEMENTATION DEFINED:
 - cache clean by MVA
 - cache invalidate by MVA
 - cache clean and invalidate by MVA.

However, one of the following approaches must be adopted in all these cases:

1. If the operation specified an invalidation a locked entry is invalidated from the cache. For the clean and invalidate operation, the entry must be cleaned before it is invalidated.
2. If the operation specified an invalidation a locked entry is not invalidated from the cache. If the operation specified a clean it is IMPLEMENTATION DEFINED whether locked entries are cleaned.
3. If an entry is locked down, or could be locked down, an IMPLEMENTATION DEFINED Data Abort exception is generated, using the fault status code defined for this purpose in CP15 c5, see either:
 - *Fault Status and Fault Address registers in a VMSA implementation* on page B3-48
 - *Fault Status and Fault Address registers in a PMSA implementation* on page B4-18.

An implementation that uses the abort mechanisms for entries that could be locked must:

- document IMPLEMENTATION DEFINED code sequences that then perform the required operation on entries that are not locked down

- implement one of the other permitted alternatives for the locked entries.

ARM recommends that, where possible, architecturally-defined operations are used in such code sequences. This minimizes the number of customized operations required.

In addition, any implementation that uses aborts for handling cache maintenance operations on entries that might be locked must provide a mechanism that can be used to ensure that no entries are locked in the cache. The reset setting of the cache must be that no cache entries are locked.

On an ARMv7-A implementation, similar rules apply to TLB lockdown, see *The interaction of TLB maintenance operations with TLB lockdown* on page B3-57.

Additional cache functions for the implementation of lockdown

An implementation can add additional cache maintenance functions for the handling of lockdown in the IMPLEMENTATION DEFINED spaces reserved for Cache Lockdown. Examples of possible functions are:

- Operations that unlock all cache entries.
- Operations that preload into specific levels of cache. These operations might be provided for instruction caches, data caches, or both.

An implementation can add other functions as required.

B2.2.6 Branch predictors

Branch predictor hardware typically uses a form of cache to hold branch information. The ARM architecture permits this branch predictor hardware to be visible to the functional behavior of software, and so the branch predictor is not architecturally invisible. This means that under some circumstances software must perform branch predictor maintenance to avoid incorrect execution caused by out of date entries in the branch predictor.

Branch prediction maintenance operations

In some implementations, to ensure correct operation it might be necessary to invalidate branch prediction entries on a change of instruction or instruction address mapping. For more information, see *Branch predictor maintenance operations and the memory order model* on page B2-20.

Two CP15 c7 operations apply to branch prediction hardware, these two functions are:

```
MCR p15, 0, Rt, c7, c5, 6:   Invalidate entire branch predictor array
MCR p15, 0, Rt, c7, c5, 7:   Invalidate MVA from branch predictor array
```

In ARMv7, these functions can perform a NOP if the operation of Branch Prediction hardware is not visible architecturally.

The invalidate entire branch predictor array operation ensures that any location held in the branch predictor has no functional effect on execution.

The invalidate MVA from branch predictor array operation operates on the address of the branch instruction. It includes the current system ASID and the security state when determining which line is affected as part of any required VA to PA translation. Security state checking is performed only if the Security Extensions are implemented. The invalidate by MVA operation can affect other branch predictor entries.

———— **Note** —————

The architecture does not make visible the range of addresses in a branch predictor to which the invalidate operation applies. This means the address used in the invalidate MVA instruction must be the address of the branch to be invalidated.

If the correct functioning of a system requires invalidation of the branch predictor when there are changes to the instructions in memory, the invalidate entire instruction cache operation also causes an invalidate entire branch predictor array operation.

Branch predictor maintenance operations and the memory order model

The following rule describes the effect of the memory order model on the branch predictor maintenance operations:

- Any invalidation of the branch predictor is guaranteed to take effect only after one of the following:
 - execution of a ISB instruction
 - taking an exception
 - return from an exception.

Therefore, if a branch instruction appears between an invalidate branch prediction instruction and an ISB operation, exception entry or exception return, it is UNPREDICTABLE whether the branch instruction is affected by the invalidate. Software must avoid this ordering of instructions, because it might lead to UNPREDICTABLE behavior.

The branch predictor maintenance operations must be used to invalidate entries in the branch predictor after any of the following events:

- enabling or disabling the MMU
- writing new data to instruction locations
- writing new mappings to the translation tables
- changes to the TTBR0, TTBR1, or TTBCR registers, unless accompanied by a change to the ContextID or the FCSE ProcessID.

Failure to invalidate entries might give UNPREDICTABLE results, caused by the execution of old branches.

In ARMv7, there is no requirement to use the branch predictor maintenance operations to invalidate the branch predictor after:

- changing the ContextID or FCSE ProcessID.
- a cache operation that is identified as also flushing the branch target cache, see either:
 - *CP15 c7, Cache and branch predictor maintenance functions* on page B3-126 for a VMSA implementation
 - *CP15 c7, Cache and branch predictor maintenance functions* on page B4-68 for a PMSA implementation.

Note

In ARMv6, the branch predictor must be invalidated after a change to the ContextID or FCSE ProcessID, see *c13, Context ID support* on page AppxG-54.

Behavior of the branch predictors at reset

In ARMv7:

- If branch predictors are not architecturally invisible the branch prediction logic is disabled at reset.
- An implementation can require the use of a specific branch predictor initialization routine to invalidate its storage array before it is enabled. The exact form of any required initialization routine is IMPLEMENTATION DEFINED, but the routine must be documented clearly as part of the documentation of the device.
- ARM recommends that whenever an invalidation routine is required, it is based on the ARMv7 branch predictor maintenance operations.

When it is enabled the state of the branch predictor logic is UNPREDICTABLE if the appropriate initialization routine has not been performed.

Similar rules apply:

- to cache behavior, see *Behavior of the caches at reset* on page B2-6
- on an ARMv7-A implementation, to TLB behavior, see *TLB behavior at reset* on page B3-55.



B2.2.7 Ordering of cache and branch predictor maintenance operations

The following rules describe the effect of the memory order model on the cache and branch predictor maintenance operations:

- All cache and branch predictor maintenance operations are executed, relative to each other, in program order.
- On an ARMv7-A implementation, where a cache or branch predictor maintenance operation appears in program order before a change to the translation tables, the cache or branch predictor maintenance operation is guaranteed to take place before the change to the translation tables is visible.

- On an ARMv7-A implementation, where a change of the translation tables appears in program order before a cache or branch predictor maintenance operation, ~~that change is guaranteed to be visible only after the sequence outlined in *TLB maintenance operations and the memory order model* on page B3-59 is executed.~~ 
- A DMB instruction causes the effect of all data cache or unified cache maintenance operations appearing in program order before the DMB to be visible to all explicit load and store operations appearing in program order after the DMB.

It also ensures that the effects of any data cache or unified cache maintenance operations appearing in program order before the DMB are observable by any observer in the same required shareability domain before any data cache or unified cache maintenance or explicit memory operations appearing in program order after the DMB are observed by the same observer. Completion of the DMB does not guarantee the visibility of all data to other observers. For example, all data might not be visible to a translation table walk, or to instruction fetches.

- A DSB causes the completion of all cache maintenance operations appearing in program order before the DSB instruction.
- An ISB instruction or an exception entry or a return from exception causes the effect of all ~~branch predictor maintenance operations appearing in program order before the ISB instruction, exception entry or exception return to be visible to all instructions after the ISB instruction, exception entry or exception return.~~ 
- Any data cache or unified cache maintenance operation by MVA must be executed in program order relative to any explicit load or store on the same processor to an address covered by the MVA of the cache operation. The order of memory accesses that result from the cache maintenance operation, relative to any other memory accesses, are subject to the memory ordering rules. For more information, see *Ordering requirements for memory accesses* on page A3-45.
- There is no restriction on the ordering of data cache or unified cache maintenance operations by MVA relative to any explicit load or store on the same processor where the address of the explicit load or store is not covered by the MVA of the cache operation. Where the ordering must be restricted, a DMB instruction must be inserted to enforce ordering.
- There is no restriction on the ordering of a data cache or unified cache maintenance operation by set/way relative to any explicit load or store on the same processor. Where the ordering must be restricted, a DMB instruction must be inserted to enforce ordering.
- The execution of a data cache or unified cache maintenance operation by set/way might not be visible to other observers in the system until after a DSB instruction is executed.
- The execution of an instruction cache ~~maintenance operation is guaranteed to be complete only after the execution of a DSB instruction.~~ 
- ~~The completion of an instruction cache maintenance operation is guaranteed to be visible to the instruction fetch only after the execution of an ISB instruction or an exception entry or return from exception.~~ 

The ~~last two points mean that the~~ sequence of cache cleaning operations for a line of self-modifying code on a uniprocessor system is:

```

; Enter this code with <Rx> containing the new 32-bit instruction. Use STRH in the first
; line instead of STR for a 16-bit instruction.
STR    <Rx>, [instruction location]
Clean data cache by MVA to point of unification [instruction location]
DSB    ; Ensures visibility of the data cleaned from the data cache
Invalidate instruction cache by MVA [instruction location]
Invalidate BTC entry by MVA [instruction location]
DSB    ; Ensures completion of the instruction cache invalidation
ISB

```

B2.2.8 Multiprocessor effects on cache maintenance operations

This section describes the multiprocessor effects on cache maintenance operations for the base ARMv7 architecture and the base ARMv7 architecture with Multiprocessing Extensions.

Base ARMv7 architecture

The base ARMv7 architecture defines that all cache maintenance operations apply only to the caches directly attached to the processor on which the operation is executed. There is no requirement that cache maintenance operations influence all processors with which the data can be shared.

In porting an architecturally portable multiprocessor operating system to ARMv7, when a cache maintenance operation is performed, *Inter-Processor Interrupts* (IPIs) must be used to inform other processors in a multiprocessor configuration that they must perform the equivalent operation.

Multiprocessing Extensions

To improve the implementation of multiprocessor systems, a set of extensions to ARMv7, called the Multiprocessing Extensions, has been introduced. These expand the role of cache and branch predictor maintenance operations in the multiprocessing system. For the VMSA architecture, the Multiprocessing Extensions also extend the role of TLB operations. For more information see *Multiprocessor effects on TLB maintenance operations* on page B3-62.

The extensions can be implemented in a uniprocessor system with no hardware support for cache coherency. In such a system, the Inner Shareable and Outer Shareable domains would be limited to being the single processor, and all instructions defined to apply to the Inner Shareable domains behave as aliases of the local operations.

Data and Unified cache operations to the point of coherency

The following instructions have an effect on data and unified caches to the point of coherency, and must affect the caches of other processors in the shareability domain described by the shareability attributes of the MVA passed with the instruction:

- invalidate data, or unified, cache line by MVA to the point of coherency (DCIMVAC)
- clean data, or unified, cache line by MVA to the point of coherency (DCCMVAC)
- clean and invalidate data (or unified) cache line by MVA to the point of coherency (DCCIMVAC).

Table B2-1 shows, for these instructions, the minimum set of processors that they affect, and the earliest point that the operations occur to depends upon the shareability attribute of the address being used.

Table B2-1 Processors affected by Data and Unified cache operations

Shareability	Processors affected	Point that the operations occur to
Non-shareable	The processor executing the instruction	Point of coherency of the entire system
Inner Shareable	All processors in the same Inner Shareable shareability domain as the processor executing the instruction	Point of coherency of the entire system
Outer Shareable	All processors in the same Outer shareable shareability domain as the processor executing the instruction	Point of coherency of the entire system

Address based cache maintenance operations not to the point of coherency

The following operations are redefined in the Multiprocessing Extensions:

- Clean data, or unified, cache line by MVA to the point of unification (DCCMVAU)
- Invalidate instruction cache line by MVA to point of unification (ICIMVAU)
- Invalidate MVA from branch predictor array (BPIMVA)

Table B2-2 shows, for these instructions, the minimum set of processors that they effect, and the earliest point that the operations occur to depends upon the shareability attribute of the address being used.

Table B2-2 Processors affected by Address based cache maintenance operations

Shareability of the Address	Processors affected	Point that the operations occur to
Non-Shareable	The processor executing the instruction	To the point of unification of instruction cache fills, data cache fills and writebacks, and translation table walks on the processor executing the instruction
Inner Shareable or Outer shareable	All processors in the same Inner Shareable shareability domain as the processor executing the instruction	To the point of unification of instruction cache fills, data cache fills and writebacks, and translation table walks of all processors in the same Inner Shareable shareability domain as the processor executing the instruction

Note

The set of processors that is guaranteed to be affected is never greater than the Inner Shareable shareability domain containing the executing processor.

Entire and set/way based cache maintenance operations

This section describes the Local and Inner Shareable instructions for entire and set/way based cache maintenance operations:

- Local instructions** The following instructions are only guaranteed to apply to the caches of the processor that the instructions are run on:
- Invalidate entire instruction cache (ICIALLU)
 - Invalidate entire branch predictor array (BPIALL)
 - Clean and Invalidate data or unified cache line by set/way (DCCISW)
 - Clean data or unified cache line by set/way (DCCSW)
 - Invalidate data or unified cache line by set/way (DCISW).

These operations have an effect on the processor executing the instruction.

These operations are functionally unchanged from the base architecture.

Inner Shareable instructions

The following instructions can be applied to the caches of all processors in the same Inner Shareable shareability domain as the processor executing the instruction:

- Invalidate entire branch predictor array Inner Shareable (BPIALLIS)
- Invalidate entire instruction cache Inner Shareable (ICIALLUIS).

ICIALLUIS automatically performs the BPIALLIS function, in the same way as ICIALLU automatically performs the BPIALL function.

These operations have an effect to the point of unification of instruction cache fills, data cache fills and writebacks, and translation table walks of all processors in the same Inner Shareable shareability domain.

These instructions complement the ICIALLU and BPIALL instructions defined in the base ARMv7 architecture, and extend them to the same Inner Shareable shareability domain.

Inner Shareable instructions encodings:

- ICIALLUIS is encoded as MCR p15, 0, <Rt>, c7, c1, 0
- BPIALLIS is encoded as MCR p15, 0, <Rt>, c7, c1, 6

B2.2.9 System-level caches

The system-level architecture might define further aspects of the software view of caches and the memory model that are not defined by the ARMv7 processor architecture. These aspects of the system-level architecture can affect the requirements for software management of caches and coherency. For example, a system design might introduce additional levels of caching that cannot be managed using the CP15 maintenance operations defined by the ARMv7 architecture. Typically, such caches are referred to as *system caches* and are managed through the use of memory-mapped operations. The ARMv7 architecture does not forbid the presence of system caches that are outside the scope of the architecture, but ARM strongly recommends the following for any such cache:

- Physical, rather than virtual, addresses are used for address-based cache maintenance operations.
- Any IMPLEMENTATION DEFINED system cache maintenance operations include as a minimum the set of functions defined by *ARMv7 cache maintenance operations* on page B2-13, with the number of levels of system cache operated on by these cache maintenance operations being IMPLEMENTATION DEFINED.
- Where possible, such system caches are included in the caches affected by the architecturally-defined CP15 cache maintenance operations, so that the architecturally-defined software sequences for managing the memory model and coherency are sufficient for managing all caches in the system.

B2.3 IMPLEMENTATION DEFINED memory system features

ARMv7 reserves space in the SCTLR for use with IMPLEMENTATION DEFINED features of the cache, and other IMPLEMENTATION DEFINED features of the memory system architecture.

In particular, in ARMv7 the following memory system features are IMPLEMENTATION DEFINED:

- Cache lockdown, see *Cache lockdown* on page B2-8.
- In VMSAv7, TLB lockdown, see *TLB lockdown* on page B3-56.
- *Tightly Coupled Memory* (TCM) support, including any associated DMA scheme. The TCM Type Register, TCMTR is required in all implementations, and if no TCMs are implemented this must be indicated by the value of this register.

———— **Note** —————

For details of the optional TCMs and associated DMA scheme in ARMv6 see *Tightly Coupled Memory (TCM) support* on page AppxG-23.

B2.3.1 ARMv7 CP15 register support for IMPLEMENTATION DEFINED features

The ARMv7 CP15 registers implementation includes the following support for IMPLEMENTATION DEFINED features of the memory system:

- The TCM Type Register, TCMTR, in CP15 c0, must be implemented. The following conditions apply to this register:
 - If no TCMs are implemented, the TCMTR indicates zero-size TCMs. For more information see *c0, TCM Type Register (TCMTR)* on page B3-85 (for a VMSA implementation) or *c0, TCM Type Register (TCMTR)* on page B4-35 (for a PMSA implementation).
 - If bits [31:29] are 0b100, the format of the rest of the register format is IMPLEMENTATION DEFINED. This value indicates that the implementation includes TCMs that do not follow the ARMv6 usage model. Other fields in the register might give more information about the TCMs.

For more information, see:

- *c0, TCM Type Register (TCMTR)* on page B3-85, for a VMSA implementation
 - *c0, TCM Type Register (TCMTR)* on page B4-35, for a PMSA implementation.
- The CP15 c9 encoding space with $\langle CRm \rangle = \{0-2,5-7\}$ is IMPLEMENTATION DEFINED for all values of $\langle opc2 \rangle$ and $\langle opc1 \rangle$. This space is reserved for branch predictor, cache and TCM functionality, for example maintenance, override behaviors and lockdown. It permits:
 - ARMv6 backwards compatible schemes
 - alternative schemes.
- For more information, see:
- *CP15 c9, Cache and TCM lockdown registers and performance monitors* on page B3-141, for a VMSA implementation
 - *CP15 c9, Cache and TCM lockdown registers and performance monitors* on page B4-74, for a PMSA implementation.

- In a VMSAv7 implementation, part of the CP15 c10 encoding space is IMPLEMENTATION DEFINED and reserved for TLB functionality, see *TLB lockdown* on page B3-56.
- The CP15 c11 encoding space with $\langle Crm \rangle = \{0-8,15\}$ is IMPLEMENTATION DEFINED for all values of $\langle opc2 \rangle$ and $\langle opc1 \rangle$. This space is reserved for DMA operations to and from the TCMs It permits:
 - an ARMv6 backwards compatible scheme
 - an alternative scheme.

For more information, see:

- *CP15 c11, Reserved for TCM DMA registers* on page B3-147, for a VMSA implementation
- *CP15 c11, Reserved for TCM DMA registers* on page B4-75, for a PMSA implementation.

B2.4 Pseudocode details of general memory system operations

This section contains pseudocode describing general memory operations, in the subsections:

- *Memory data type definitions.*
- *Basic memory accesses* on page B2-30.
- *Interfaces to memory system specific pseudocode* on page B2-30.
- *Aligned memory accesses* on page B2-31
- *Unaligned memory accesses* on page B2-32
- *Reverse endianness* on page B2-34
- *Exclusive monitors operations* on page B2-35
- *Access permission checking* on page B2-37
- *Default memory access decode* on page B2-37
- *Data Abort exception* on page B2-39.

The pseudocode in this section applies to both VMSA and PMSA implementations. Additional pseudocode for memory operations is given in:

- *Pseudocode details of VMSA memory system operations* on page B3-156
- *Pseudocode details of PMSA memory system operations* on page B4-79.

B2.4.1 Memory data type definitions

The following data type definitions are used by the memory system pseudocode functions:

```
// Types of memory

enumeration MemType {MemType_Normal, MemType_Device, MemType_StronglyOrdered};

// Memory attributes descriptor

type MemoryAttributes is (
    MemType type,
    bits(2) innerattrs, // '00' = Non-cacheable; '01' = WBWA; '10' = WT; '11' = WBnWA
    bits(2) outerattrs, // '00' = Non-cacheable; '01' = WBWA; '10' = WT; '11' = WBnWA
    boolean shareable,
    boolean outershareable
)

// Physical address type, with extra bits used by some VMSA features

type FullAddress is (
    bits(32) physicaladdress,
    bits(8) physicaladdressextr,
    bit    NS // '0' = Secure, '1' = Non-secure
)

// Descriptor used to access the underlying memory array

type AddressDescriptor is (
    MemoryAttributes memattrs,
```

```

    FullAddress    address
)

// Access permissions descriptor

type Permissions is (
    bits(3) ap,    // Access Permission bits
    bit    xn     // Execute Never bit
)

```

B2.4.2 Basic memory accesses

The `_Mem[]` function performs single-copy atomic, aligned, little-endian memory accesses to the underlying physical memory array of bytes:

```

bits(8*size) _Mem[AddressDescriptor memaddrdesc, integer size]
    assert size == 1 || size == 2 || size == 4 || size == 8;

_Mem[AddressDescriptor memaddrdesc, integer size] = bits(8*size) value
    assert size == 1 || size == 2 || size == 4 || size == 8;

```

This function addresses the array using `memaddrdesc.address`, that supplies:

- A 32-bit physical address.
- An 8-bit physical address extension, that is treated as additional high-order bits of the physical address. This extension is always 0b00000000 in the PMSA.
- A single NS bit to select between Secure and Non-secure parts of the array. This bit is always 0 if the Security Extensions are not implemented.

The actual implemented array of memory might be smaller than the 2^{41} bytes implied. In this case, the scheme for aliasing is IMPLEMENTATION DEFINED, or some parts of the address space might give rise to external aborts. For more information, see:

- *External aborts* on page B3-45 for a VMSA implementation
- *External aborts* on page B4-15 for a PMSA implementation.

The attributes in `memaddrdesc.memattrs` are used by the memory system to determine caching and ordering behaviors as described in *Memory types and attributes and the memory order model* on page A3-24.

B2.4.3 Interfaces to memory system specific pseudocode

The following functions call the VMSA-specific or PMSA-specific functions to handle Alignment faults and perform address translation.

```

// AlignmentFault()
// =====

AlignmentFault(bits(32) address, boolean iswrite)
    case MemorySystemArchitecture() of
        when MemArch_VMSA AlignmentFaultV(address, iswrite);

```



```

        when MemArch_PMSA AlignmentFaultP(address, iswrite);

// TranslateAddress()
// =====

AddressDescriptor TranslateAddress(bits(32) VA, boolean ispriv, boolean iswrite)
    case MemorySystemArchitecture() of
        when MemArch_VMSA return TranslateAddressV(VA, ispriv, iswrite);
        when MemArch_PMSA return TranslateAddressP(VA, ispriv, iswrite);

```

B2.4.4 Aligned memory accesses

The MemA[] function performs a memory access at the current privilege level, and the MemA_unpriv[] function performs an access that is always unprivileged. In both cases the architecture requires the access to be aligned, and in ARMv7 the function generates an Alignment fault if it is not.

———— Note ————

In versions of the architecture before ARMv7, if the SCTL.R.A and SCTL.R.U bits are both 0, an unaligned access is forced to be aligned by replacing the low-order address bits with zeros.

```

// MemA[]
// =====

bits(8*size) MemA[bits(32) address, integer size]
    return MemA_with_priv[address, size, CurrentModeIsPrivileged()];

MemA[bits(32) address, integer size] = bits(8*size) value
    MemA_with_priv[address, size, CurrentModeIsPrivileged()] = value;
    return;

// MemA_unpriv[]
// =====

bits(8*size) MemA_unpriv[bits(32) address, integer size]
    return MemA_with_priv[address, size, FALSE];

MemA_unpriv[bits(32) address, integer size] = bits(8*size) value
    MemA_with_priv[address, size, FALSE] = value;
    return;

// MemA_with_priv[]
// =====

// Non-assignment form

bits(8*size) MemA_with_priv[bits(32) address, integer size, boolean privileged]

    // Sort out alignment
    if address == Align(address, size) then
        VA = address;
    elsif SCTL.R.A == '1' || SCTL.R.U == '1' then

```

```

        AlignmentFault(address, FALSE);
    else // if legacy non alignment-checking configuration
        VA = Align(address, size);

    // MMU or MPU
    memaddrdesc = TranslateAddress(VA, privileged, FALSE);

    // Memory array access, and sort out endianness
    value = _Mem[memaddrdesc, size];
    if CPSR.E == '1' then
        value = BigEndianReverse(value, size);

    return value;

// Assignment form
MemA_with_priv[bits(32) address, integer size, boolean privileged] = bits(8*size) value

    // Sort out alignment
    if address == Align(address, size) then
        VA = address;
    elseif SCTL.R.A == '1' || SCTL.R.U == '1' then
        AlignmentFault(address, FALSE);
    else // if legacy non alignment-checking configuration
        VA = Align(address, size);

    // MMU or MPU
    memaddrdesc = TranslateAddress(VA, privileged, TRUE);

    // Effect on exclusives
    if memaddrdesc.memattrs.shareable then
        ClearExclusiveByAddress(memaddrdesc.physicaladdress, ProcessorID(), size);

    // Sort out endianness, then memory array access
    if CPSR.E == '1' then
        value = BigEndianReverse(value, size);
    _Mem[memaddrdesc, size] = value;

    return;

```

B2.4.5 Unaligned memory accesses

The MemU[] function performs a memory access at the current privilege level, and the MemU_unpriv[] function performs an access that is always unprivileged.

In both cases:

- if the SCTL.R.A bit is 0, unaligned accesses are supported
- if the SCTL.R.A bit is 1, unaligned accesses produce Alignment faults.

Note

In versions of the architecture before ARMv7, if the SCTL.R.A and SCTL.R.U bits are both 0, an unaligned access is forced to be aligned by replacing the low-order address bits with zeros.

```

// MemU[]
// =====

bits(8*size) MemU[bits(32) address, integer size]
    return MemU_with_priv[address, size, CurrentModeIsPrivileged()];

MemU[bits(32) address, integer size] = bits(8*size) value
    MemU_with_priv[address, size, CurrentModeIsPrivileged()] = value;
    return;

// MemU_unpriv[]
// =====

bits(8*size) MemU_unpriv[bits(32) address, integer size]
    return MemU_with_priv[address, size, FALSE];

MemU_unpriv[bits(32) address, integer size] = bits(8*size) value
    MemU_with_priv[address, size, FALSE] = value;
    return;

// MemU_with_priv[]
// =====
//
// Due to single-copy atomicity constraints, the aligned accesses are distinguished from
// the unaligned accesses:
// * aligned accesses are performed at their size
// * unaligned accesses are expressed as a set of bytes.

// Non-assignment form

bits(8*size) MemU_with_priv[bits(32) address, integer size, boolean privileged]

    bits(8*size) value;

    // Legacy non alignment-checking configuration forces access to be aligned
    if SCTL.R.A == '0' && SCTL.R.U == '0' then address = Align(address, size);

    // Do aligned access, take alignment fault, or do sequence of bytes
    if address == Align(address, size) then
        value = MemA_with_priv[address, size, privileged];
    elseif SCTL.R.A == '1' then
        AlignmentFault(address, FALSE);
    else // if unaligned access, SCTL.R.A == '0', and SCTL.R.U == '1'
        for i = 0 to size-1
            value<8*i+7:8*i> = MemA_with_priv[address+i, 1, privileged];
        if CPSR.E == '1' then
            value = BigEndianReverse(value, size);

```

```

    return value;

// Assignment form
MemU_with_priv[bits(32) address, integer size, boolean privileged] = bits(8*size) value

// Legacy non alignment-checking configuration forces access to be aligned
if SCTRL.A == '0' && SCTRL.U == '0' then address = Align(address, size);

// Do aligned access, take alignment fault, or do sequence of bytes
if address == Align(address, size) then
    MemA_with_priv[address, value, privileged] = value;
elseif SCTRL.A == '1' then
    AlignmentFault(address, TRUE);
else // if unaligned access, SCTRL.A == '0', and SCTRL.U == '1'
    if CPSR.E == '1' then
        value = BigEndianReverse(value, size);
        for i = 0 to size-1
            MemA_with_priv[address+i, 1, privileged] = value<8*i+7:8*i>;

return;

```

B2.4.6 Reverse endianness

The following pseudocode describes the operation to reverse endianness:

```

// BigEndianReverse()
// =====

bits(8*N) BigEndianReverse (bits(8*N) value, integer N)
assert N == 1 || N == 2 || N == 4 || N == 8;
bits(8*N) result;
case N of
    when 1
        result<7:0> = value<7:0>;
    when 2
        result<15:8> = value<7:0>;
        result<7:0> = value<15:8>;
    when 4
        result<31:24> = value<7:0>;
        result<23:16> = value<15:8>;
        result<15:8> = value<23:16>;
        result<7:0> = value<31:24>;
    when 8
        result<63:56> = value<7:0>;
        result<55:48> = value<15:8>;
        result<47:40> = value<23:16>;
        result<39:32> = value<31:24>;
        result<31:24> = value<39:32>;
        result<23:16> = value<47:40>;
        result<15:8> = value<55:48>;
        result<7:0> = value<63:56>;
return result;

```

B2.4.7 Exclusive monitors operations

The `SetExclusiveMonitors()` function sets the exclusive monitors for a Load-Exclusive instruction. The `ExclusiveMonitorsPass()` function checks whether a Store-Exclusive instruction still has possession of the exclusive monitors and therefore completes successfully.

```
// SetExclusiveMonitors()
// =====

SetExclusiveMonitors(bits(32) address, integer size)

    memaddrdesc = TranslateAddress(address, CurrentModeIsPrivileged(), FALSE);

    if memaddrdesc.memattrs.shareable then
        MarkExclusiveGlobal(memaddrdesc.physicaladdress, ProcessorID(), size);

        MarkExclusiveLocal(memaddrdesc.physicaladdress, ProcessorID(), size);

// ExclusiveMonitorsPass()
// =====

boolean ExclusiveMonitorsPass(bits(32) address, integer size)

    // It is IMPLEMENTATION DEFINED whether the detection of memory aborts happens
    // before or after the check on the local Exclusive Monitor. As a result a failure
    // of the local monitor can occur on some implementations even if the memory
    // access would give an memory abort.

    if address != Align(address, size) then
        AlignmentFault(address, TRUE);
    else
        memaddrdesc = TranslateAddress(address, CurrentModeIsPrivileged(), TRUE);

        passed = IsExclusiveLocal(memaddrdesc.paddress, ProcessorID(), size);
        if memaddrdesc.memattrs.shareable then
            passed = passed && IsExclusiveGlobal(memaddrdesc.paddress, ProcessorID(), size);

        if passed then
            ClearExclusiveLocal(ProcessorID());

    return passed;
```

The `MarkExclusiveGlobal()` procedure takes as arguments a `FullAddress` `address`, the processor identifier `processorid` and the size of the transfer. The procedure records that processor `processorid` has requested exclusive access covering at least `size` bytes from address `address`. The size of region marked as exclusive is IMPLEMENTATION DEFINED, up to a limit of 2KB, and no smaller than two words, and aligned in the address space to the size of the region. It is UNPREDICTABLE whether this causes any previous request for exclusive access to any other address by the same processor to be cleared.

```
MarkExclusiveGlobal(FullAddress paddress, integer processorid, integer size)
```

The `MarkExclusiveLocal()` procedure takes as arguments a `FullAddress` address, the processor identifier `processorid` and the size of the transfer. The procedure records in a local record that processor `processorid` has requested exclusive access to an address covering at least `size` bytes from address `address`. The size of the region marked as exclusive is IMPLEMENTATION DEFINED, and can at its largest cover the whole of memory, but is no smaller than two words, and is aligned in the address space to the size of the region. It is IMPLEMENTATION DEFINED whether this procedure also performs a `MarkExclusiveGlobal()` using the same parameters.

`MarkExclusiveLocal(FullAddress address, integer processorid, integer size)`

The `IsExclusiveGlobal()` function takes as arguments a `FullAddress` address, the processor identifier `processorid` and the size of the transfer. The function returns `TRUE` if the processor `processorid` has marked in a global record an address range as exclusive access requested that covers at least the `size` bytes from address `address`. It is IMPLEMENTATION DEFINED whether it returns `TRUE` or `FALSE` if a global record has marked a different address as exclusive access requested. If no address is marked in a global record as exclusive access, `IsExclusiveGlobal()` returns `FALSE`.

`boolean IsExclusiveGlobal(FullAddress address, integer processorid, integer size)`

The `IsExclusiveLocal()` function takes as arguments a `FullAddress` address, the processor identifier `processorid` and the size of the transfer. The function returns `TRUE` if the processor `processorid` has marked an address range as exclusive access requested that covers at least the `size` bytes from address `address`. It is IMPLEMENTATION DEFINED whether this function returns `TRUE` or `FALSE` if the address marked as exclusive access requested does not cover all of the `size` bytes from address `address`. If no address is marked as exclusive access requested, then this function returns `FALSE`. It is IMPLEMENTATION DEFINED whether this result is ANDed with the result of `IsExclusiveGlobal()` with the same parameters.

`boolean IsExclusiveLocal(FullAddress address, integer processorid, integer size)`

The `ClearExclusiveByAddress()` procedure takes as arguments a `FullAddress` address, the processor identifier `processorid` and the size of the transfer. The procedure clears the global records of all processors, other than `processorid`, for which an address region including any of the `size` bytes starting from `address` has had a request for an exclusive access. It is IMPLEMENTATION DEFINED whether the equivalent global record of the processor `processorid` is also cleared if any of the `size` bytes starting from `address` has had a request for an exclusive access, or if any other address has had a request for an exclusive access.

`ClearExclusiveByAddress(FullAddress address, integer processorid, integer size)`

The `ClearExclusiveLocal()` procedure takes as arguments the processor identifier `processorid`. The procedure clears the local record of processor `processorid` for which an address has had a request for an exclusive access. It is IMPLEMENTATION DEFINED whether this operation also clears the global record of processor `processorid` that an address has had a request for an exclusive access.

`ClearExclusiveLocal(integer processorid)`

B2.4.8 Access permission checking

The function `CheckPermission()` is used by both the VMSA and PMSA architectures to perform access permission checking based on attributes derived from the translation tables or region descriptors. The domain and sectionnotpage arguments are only relevant for the VMSA architecture.

The interpretation of the access permissions is shown in:

- *Access permissions* on page B3-28, for a VMSA implementation
- *Access permissions* on page B4-9, for a PMSA implementation.

The following pseudocode describes the checking of the access permission:

```
// CheckPermission()
// =====

CheckPermission(Permissions perms, bits(32) mva,
                boolean sectionnotpage, bits(4) domain, boolean iswrite, boolean ispriv)

if SCTL.AFE == '0' then
    perms.ap<0> = '1';

case perms.ap of
    when '000' abort = TRUE;
    when '001' abort = !ispriv;
    when '010' abort = !ispriv && iswrite;
    when '011' abort = FALSE;
    when '100' UNPREDICTABLE;
    when '101' abort = !ispriv || iswrite;
    when '110' abort = iswrite;
    when '111'
        if MemorySystemArchitecture() == MemArch_VMSA then
            abort = iswrite
        else
            UNPREDICTABLE;

if abort then
    DataAbort(mva, domain, sectionnotpage, iswrite, DAbort_Permission);

return;
```

B2.4.9 Default memory access decode

The function `DefaultTEXDecode()` is used by both the VMSA and PMSA architectures to decode the `texcb` and `S` attributes derived from the translation tables or region descriptors.

The interpretation of the arguments is shown in:

- *C, B, and TEX[2:0] encodings without TEX remap* on page B3-33, for a VMSA implementation
- *C, B, and TEX[2:0] encodings* on page B4-11, for a PMSA implementation.

The following pseudocode describes the default memory access decoding, ~~when memory region remapping is not implemented~~



```

// DefaultTEXDecode()
// =====

MemoryAttributes DefaultTEXDecode(bits(5) texcb, bit S)

MemoryAttributes memattrs;

case texcb of
  when '00000'
    memattrs.type = MemType_StronglyOrdered;
    memattrs.innerattrs = '00'; // Non-cacheable
    memattrs.outerattrs = '00'; // Non-cacheable
    memattrs.shareable = TRUE;
  when '00001'
    memattrs.type = MemType_Device;
    memattrs.innerattrs = '00'; // Non-cacheable
    memattrs.outerattrs = '00'; // Non-cacheable
    memattrs.shareable = TRUE;
  when '0001x', '00100'
    memattrs.type = MemType_Normal;
    memattrs.innerattrs = texcb<1:0>;
    memattrs.outerattrs = texcb<1:0>;
    memattrs.shareable = (S == '1');
  when '00110'
    IMPLEMENTATION_DEFINED setting of memattrs;
  when '00111'
    memattrs.type = MemType_Normal;
    memattrs.innerattrs = '01'; // Write-back write-allocate cacheable
    memattrs.outerattrs = '01'; // Write-back write-allocate cacheable
    memattrs.shareable = (S == '1');
  when '01000'
    memattrs.type = MemType_Device;
    memattrs.innerattrs = '00'; // Non-cacheable
    memattrs.outerattrs = '00'; // Non-cacheable
    memattrs.shareable = FALSE;
  when '1xxxx'
    memattrs.type = MemType_Normal;
    memattrs.innerattrs = texcb<1:0>;
    memattrs.outerattrs = texcb<3:2>;
    memattrs.shareable = (S == '1');
  otherwise
    UNPREDICTABLE;

memattrs.outershareable = memattrs.shareable;

return memattrs;

```

B2.4.10 Data Abort exception

The `DataAbort()` function generates a Data Abort exception and is used by both the VMSA and PMSA architectures. It sets the DFSR to indicate:

- the type of the abort, including the distinction between section and page on a VMSA implementation
- on a VMSA implementation, the domain, if appropriate
- whether the access was a read or write.

For a synchronous abort it also sets the DFAR to the MVA of the abort.

For details of the FSR encoding values see:

- *Fault Status Register encodings for the VMSA* on page B3-50, for a VMSA implementation
- *Fault Status Register encodings for the PMSA* on page B4-19, for a PMSA implementation.

An implementation might also set the IMPLEMENTATION DEFINED ADFSR.

// Data abort types.

```
enumeration DAbort {DAbort_AccessFlag,
                    DAbort_Alignment,
                    DAbort_Background,
                    DAbort_Domain,
                    DAbort_Permission,
                    DAbort_Translation};
```

`DataAbort(bits(32) address, bits(4) domain, boolean sectionnotpage, boolean iswrite, DAbort type)`

Chapter B3

Virtual Memory System Architecture (VMSA)

This chapter provides a system-level view of the Virtual Memory System Architecture (VMSA), the memory system architecture of an ARMv7-A implementation. It contains the following sections:

- *About the VMSA* on page B3-2
- *Memory access sequence* on page B3-4
- *Translation tables* on page B3-7
- *Address mapping restrictions* on page B3-23
- *Secure and Non-secure address spaces* on page B3-26
- *Memory access control* on page B3-28
- *Memory region attributes* on page B3-32
- *VMSA memory aborts* on page B3-40
- *Fault Status and Fault Address registers in a VMSA implementation* on page B3-48
- *Translation Lookaside Buffers (TLBs)* on page B3-54
- *Virtual Address to Physical Address translation operations* on page B3-63
- *CP15 registers for a VMSA implementation* on page B3-64
- *Pseudocode details of VMSA memory system operations* on page B3-156.

———— **Note** —————

For an ARMv7-A implementation, this chapter must be read with Chapter B2 *Common Memory System Architecture Features*.

B3.1 About the VMSA

Complex operating systems typically use a virtual memory system to provide separate, protected address spaces for different processes. The ARMv7 VMSA is referred to as VMSAv7. For details of the differences in previous versions of the ARM architecture see:

- *Virtual memory support* on page AppxH-21 for the ARMv4 and ARMv5 architectures
- *Virtual memory support* on page AppxG-24 for ARMv6.

In a VMSA, a *Memory Management Unit* (MMU) provides facilities that enable an operating system to dynamically allocate memory and other memory-mapped system resources to the processes. The MMU provides fine-grained control of a memory system through a set of virtual to physical address mappings and associated memory properties held in memory-mapped tables known as translation tables.

The translation properties associated with each translation table entry include:

Memory access permission control

This controls whether a program has access to a memory area. The possible settings are no access, read-only access, or read/write access. In addition, there is control of whether code can be executed from the memory area.

If a processor attempts an access that is not permitted, a memory abort is signaled to the processor.

The permitted level of access can be affected by:

- whether the program is running in User mode or a privileged mode
- the use of domains.

Memory region attributes

These describe the properties of a memory region. The top-level attribute, the Memory type, is one of Strongly-ordered, Device, or Normal. Device and Normal memory regions have additional attributes, see *Summary of ARMv7 memory attributes* on page A3-25.

Virtual-to-physical address mapping

The VMSA regards the address of an explicit data access or an instruction fetch as a *Virtual Address* (VA). The MMU maps this address onto the required *Physical Address* (PA).

VA to PA address mapping can be used to manage the allocation of physical memory in many ways. For example:

- to allocate memory to different processes with potentially conflicting address maps
- to enable an application with a sparse address map to use a contiguous region of physical memory.

A full translation table lookup is called a *translation table walk*. It is performed automatically by hardware, and has a significant cost in execution time, requiring at least one main memory access, and often two. *Translation Lookaside Buffers* (TLBs) reduce the average cost of a memory access by caching the results of translation table walks. TLBs behave as caches of the translation table information, and the VMSA provides TLB maintenance operations to manage TLB contents in software.

To reduce the software overhead of TLB maintenance, the VMSA distinguishes between *Global pages* and *Process specific pages*. The *Address Space Identifier (ASID)* identifies pages associated with a specific process and provides a mechanism for changing process specific tables without having to perform maintenance on the TLB structures.

System Control coprocessor (CP15) registers control the VMSA, including defining the location of the translation tables. They include registers that contain memory fault status and address information. See *CP15 registers for a VMSA implementation* on page B3-64. When the Security Extensions are implemented, many of the CP15 registers are banked between the Secure and Non-secure security states. This means separate system control software can be used in the different security states.

VMSAv7 supports physical addresses of up to 40 bits, though implementations are permitted to support only 32 bits of physical address. Where implementations support more than 32 bits of physical address, generating physical addresses with PA[39:32] != 0b00000000 requires the use of *Supersections*, see *Translation tables* on page B3-7.

B3.2 Memory access sequence

Explicit data accesses and instruction fetches generate memory accesses using VAs. The VA for an access is subject to two stages of address translation:

1. A translation from VA to *Modified Virtual Address* (MVA) by the FCSE, if it is implemented, see *FCSE translation*
2. A translation from MVA to PA using the translation tables, see *Translation from MVA to PA using the translation tables*.

B3.2.1 FCSE translation

The FCSE translation is a linear remapping of the bottom 32MBytes of the Virtual Address map, to a 32MByte address block determined by the FCSEIDR, see *c13, FCSE Process ID Register (FCSEIDR)* on page B3-152. Therefore, the translation is that shown by the pseudo-function FCSEtranslate, see *FCSE translation* on page B3-156.

———— Note —————

- The FCSE translation has no effect if bits FCSEIDR[31:25] are 0b0000000, see *c13, FCSE Process ID Register (FCSEIDR)* on page B3-152.
- From VMSAv6, use of FCSE translation is deprecated.
- In VMSAv7, the FCSE is optional and might not be implemented. If it is not implemented the VMSA behavior is that MVA = VA, and the FCSEIDR register is RAZ/WI.

B3.2.2 Translation from MVA to PA using the translation tables

The MMU translates the MVA to the PA. Typically, this translation attempts to find the translation table entry held in a TLB that either:

- is a global entry
- was brought into the TLB with the ASID that matches the current value held in the CONTEXTIDR, see *c13, Context ID Register (CONTEXTIDR)* on page B3-153.

If no matching entry is found in a TLB, then the hardware locates the appropriate entry in the translation tables held in memory.

When the translation table entry is located, in the TLB or in memory, either:

- It is not a valid translation, and therefore causes a Translation fault.
- The contents of the entry contain the PA, the memory permission attributes and the memory type attributes for the required access. Using the entry might cause an abort, for variety of reasons.

For more information about MMU faults see *MMU faults* on page B3-40.

B3.2.3 Enabling and disabling the MMU

The MMU can be enabled and disabled by writing to the SCTL.R.M bit, see *c1, System Control Register (SCTLR)* on page B3-96. On reset, this bit is cleared to 0, disabling the MMU.

When the MMU is disabled, memory accesses are treated as follows:

- All data accesses ~~are treated as Non-cacheable and Strongly ordered. Unexpected data-cache hit behavior is IMPLEMENTATION DEFINED.~~
- The treatment of instruction accesses depends on the value of the SCTL.R.I bit:

When I == 0

All instruction accesses are Non-cacheable.

When I == 1

All instruction accesses are Cacheable:

- Inner Write-Through no Write-Allocate
- Outer Write-Through no Write-Allocate.

In both cases all instruction accesses are Non-shareable, Normal memory.

———— **Note** ————

On some implementations, if the SCTL.R.TRE bit is set to 0 then this behavior can be changed by the remap settings in the memory remap registers, see *CP15 c10, Memory Remap Registers* on page B3-143. The details of TEX remapping when SCTL.R.TRE is set to 0 are IMPLEMENTATION DEFINED, see *SCTL.R.TRE, SCTL.R.M, and the effect of the MMU remap registers* on page B3-38.

- No memory access permission checks are performed, and no aborts are generated by the MMU.
- For every access the PA is equal to the MVA. This is known as a flat address mapping.
- If the FCSE is implemented, the FCSE PID is SBZ when the MMU is disabled. This is the reset value for the FCSE PID. Behavior is UNPREDICTABLE if the FCSE PID is not zero when the MMU is disabled.

When the FCSE is implemented software must clear the FCSE PID before disabling the MMU.

- CP15 cache maintenance operations act on the target cache whether the MMU is enabled or not, and regardless of the values of the memory attributes. However, if the MMU is disabled, they use the flat address mapping, and all mappings are considered global.

CP15 TLB invalidate operations act on the target TLB whether the MMU is enabled or not.

All relevant CP15 registers must be programmed before the MMU is enabled. This includes setting up suitable translation tables in memory.

When the MMU is disabled, an instruction can be fetched if one of the following conditions is met:

- The instruction is in the same 4KB block of memory (aligned to 4KB) as an instruction that is required by a simple sequential execution of the program, or is in the 4KB block of memory immediately following such a block.

- The instruction is in the same 4KB block of memory (aligned to 4KB) from which an instruction has previously been required by a simple sequential execution of the program with the MMU disabled, or is in the 4KB block immediately following such a block.

Note

- Software must ensure that instructions that will be executed when the MMU is disabled are located within 4KB blocks of the address space that contain only memory which is tolerant to prefetching and speculative accesses, and that the following 4KB blocks of the address space also contain only memory which is tolerant to prefetching and speculative accesses.
- Enabling or disabling the MMU effectively changes the translation tables that are in use. The synchronization requirements that apply on changing translation tables also apply to enabling or disabling the MMU. For more information, see *Changing translation table attributes* on page B3-21. See also *Requirements for instruction caches* on page B3-23.

In addition, if the physical address of the code that enables or disables the MMU differs from its MVA, instruction prefetching can cause complications. Therefore, ARM strongly recommends that any code that enables or disables the MMU has identical virtual and physical addresses.

B3.3 Translation tables

The MMU supports memory accesses based on memory sections or pages:

Supersections Consist of 16MB blocks of memory. Support for Supersections is optional.

Sections Consist of 1MB blocks of memory.

Large pages Consist of 64KB blocks of memory.

Small pages Consist of 4KB blocks of memory.

Support for Supersections, Sections and Large pages enables a large region of memory to be mapped using only a single entry in the TLB.

The translation tables held in memory have two levels:

First-level table

Holds *first-level descriptors* that contain the base address and

- translation properties for Sections and Supersections
- translation properties and pointers to a second level table for Large pages and Small pages

Second-level tables

Hold *second-level descriptors*, each containing the base address and translation properties for a Small page or a Large page. Second-level tables are also referred to as *Page tables*.

The translation tables are described in the following sections:

- *Translation table entry formats*
- *Translation table base registers* on page B3-11
- *Translation table walks* on page B3-13
- *Changing translation table attributes* on page B3-21
- *The access flag* on page B3-21.

B3.3.1 Translation table entry formats

The formats of the first-level and second-level translation table descriptor entries in the translation tables are described in:

- *First-level descriptors* on page B3-8
- *Second-level descriptors* on page B3-10.

For more information about second-level translation tables see *Additional requirements for translation tables* on page B3-11.

————— **Note** —————

In previous versions of the *ARM Architecture Reference Manual* and in some other documentation, the AP[2] bit in the translation table entries is described as the APX bit.

First-level descriptors

Each entry in the first-level table is a descriptor of how the associated 1MB MVA range is mapped. Table B3-1 shows the possible first-level descriptor formats, where the value of bits [1:0] of the descriptor identifies the descriptor type:

- 0b00** Invalid or fault entry. The associated MVA is unmapped, and attempting to access it generates a Translation fault, see *VMSA memory aborts* on page B3-40. Software can use bits [31:2] of an invalid descriptor for its own purposes, because these bits are ignored by the hardware.
- 0b01** Page table descriptor. The descriptor gives the physical address of a second-level translation table, that specifies how the associated 1MByte MVA range is mapped. A second level translation table requires 1KByte of memory and can map Large pages and Small pages, see *Second-level descriptors* on page B3-10.
- 0b10** Section or Supersection descriptor for the associated MVA. Bit [18] determines whether the descriptor is of a Section or a Supersection. For details of how the descriptor is interpreted see *The full translation flow for Sections, Supersections, Small pages and Large pages* on page B3-15.
- 0b11** Reserved. In VMSAv7, descriptors with bits [1:0] == 0b11 generate Translation faults, and must not be used.

Table B3-1 VMSAv7 first-level descriptor formats

31	24	23	20	19	18	17	16	15	14	12	11	10	9	8	5	4	3	2	1	0	
Fault	IGNORE																			0	0
Page table	Page table base address, bits [31:10]											I M P	Domain	S B Z	N S	S B Z	0	1			
Section	Section base address, PA[31:20]				N S	0	n G	S	A P [2]	TEX [2:0]	AP [1:0]	I M P	Domain	X N	C	B	1	0			
Supersection	Supersection base address PA[31:24]		Extended base address PA[35:32]		N S	1	n G	S	A P [2]	TEX [2:0]	AP [1:0]	I M P	Extended base address PA[39:36]	X N	C	B	1	0			
Reserved	Reserved																			1	1

The address information in the first-level descriptors is:

Page table Bits [31:10] of the descriptor are bits [31:10] of the physical address of a Page table.

Section Bits [31:20] of the descriptor are bits [31:20] of the physical address of the Section.

Supersection Bits [31:24] of the descriptor are bits [31:24] of the physical address of the Supersection. Optionally, bits [8:5,23:20] of the descriptor are bits [39:32] of the extended Supersection address.

The other fields in the descriptors are:

TEX[2:0], C, B

Memory region attribute bits, see *Memory region attributes* on page B3-32.

These bits are not present in a Page table entry.

XN bit

The execute-never bit. Determines whether the region is executable, see *The Execute Never (XN) attribute and instruction prefetching* on page B3-30.

This bit is not present in a Page table entry.

NS bit

Non-secure bit. When the Security Extensions are implemented this bit specifies whether the translated PA targets Secure or Non-secure memory, see *Secure and Non-secure address spaces* on page B3-26.

Domain

Domain field, see *Domains* on page B3-31.

This field is not present in a Supersection entry. Memory described by Supersections is in domain 0.

IMP bit

The meaning of this bit is IMPLEMENTATION DEFINED.

AP[2], AP[1:0]

Access Permissions bits, see *Memory access control* on page B3-28.

AP[0] can be configured as the *access flag*, see *The access flag* on page B3-21.

These bits are not present in a Page table entry.

S bit

The Shareable bit. Determines whether the translation is for Shareable memory, see *Memory region attributes* on page B3-32.

This bit is not present in a Page table entry.

nG bit

The not global bit. Determines how the translation is marked in the TLB, see *Global and non-global regions in the virtual memory map* on page B3-54.

This bit is not present in a Page table entry.

Bit [18], when bits [1:0] == 0b10

0 Descriptor is for a Section

1 Descriptor is for a Supersection.

Second-level descriptors

Table B3-2 shows the possible formats of a second-level descriptor, where bits [1:0] of the descriptor identify the descriptor type:

- 0b00** Invalid or fault entry. The associated MVA is unmapped, and attempting to access it generates a Translation fault. Software can use bits [31:2] of an invalid descriptor for its own purposes, because these bits are ignored by the hardware.
- 0b01** Large page descriptor. Bits [31:16] of the descriptor are the base address of the Large page.
- 0b1X** Small page descriptor. Bits [31:12] of the descriptor are the base address of the Small page. In this descriptor format, bit [0] of the descriptor is the XN bit.

Table B3-2 VMSAv7 second-level descriptor formats

31	16	15	14	12	11	10	9	8	7	6	5	4	3	2	1	0	
Fault	IGNORE														0	0	
Large page	Large page base address, PA[31:16]				X N	TEX [2:0]	n G	S	A P [2]	SBZ	AP [1:0]	C	B	0	1		
Small page	Small page base address, PA[31:12]						n G	S	A P [2]	TEX [2:0]	AP [1:0]	C	B	1	X N		

The address information in the second-level descriptors is:

Large page Bits [31:16] of the descriptor are bits [31:16] of the physical address of the Large page.

Small page Bits [31:12] of the descriptor are bits [31:12] of the physical address of the Small page.

The other fields in the descriptors are:

XN bit The execute-never bit. Determines whether the region is executable, see *The Execute Never (XN) attribute and instruction prefetching* on page B3-30.

TEX[2:0], C, B

Memory region attribute bits, see *Memory region attributes* on page B3-32.

AP[2], AP[1:0]

Access Permissions bits, see *Memory access control* on page B3-28.

AP[0] can be configured as the *access flag*, see *The access flag* on page B3-21.

S bit The Shareable bit. Determines whether the translation is for Shareable memory, see *Memory region attributes* on page B3-32.

nG bit The not global bit. Used in the TLB matching process, see *Global and non-global regions in the virtual memory map* on page B3-54.

Additional requirements for translation tables

Additional requirements for the entries in a translation table apply:

- to first-level translation tables when Supersection descriptors are used
- to second-level translation tables when Large page descriptors are used.

These requirements exist because the top four bits of the Supersection or Large page index region of the MVA overlap with the bottom four bits of the table index. *Translation table walks* on page B3-13 gives more information, and these two cases are shown in:

- Figure B3-5 on page B3-18 for the first-level translation table Supersection entry
- Figure B3-7 on page B3-20 for the second-level translation table Large page table entry.

Considering the case of using Large page table descriptors in a second-level translation table, this overlap means that for any specific Large page, the bottom four bits of the second-level translation table entry might take any value from 0b0000 to 0b1111. Therefore, each of these sixteen index values must point to a separate copy of the same descriptor. This means that, in a second-level translation table, each Large page descriptor must:

- occur first on a sixteen-word boundary
- be repeated in 16 consecutive memory locations.

For similar reasons, in a first-level translation table, each Supersection descriptor must also:

- occur first on a sixteen-word boundary
- be repeated in 16 consecutive memory locations.

Second-level translation tables are 1KB in size, and must be aligned on a 1KB boundary. Each 32-bit entry in a table provides translation information for 4KB of memory. VMSAv7 supports two page sizes:

- Large pages are 64KByte in size
- Small pages are 4KByte in size.

The required replication of Large page descriptors preserves this 4KB per entry relationship:

$$(4\text{KBytes per entry}) \times (16 \text{ replicated entries}) = 64\text{KBytes} = \text{Large page size}$$

B3.3.2 Translation table base registers

Three translation table registers describe the translation tables that are held in memory. For descriptions of the registers, see:

- *c2, Translation Table Base Register 0 (TTBR0)* on page B3-113
- *c2, Translation Table Base Register 1 (TTBR1)* on page B3-116
- *c2, Translation Table Base Control Register (TTBCR)* on page B3-117.

On a translation table walk, the most significant bits of the MVA and the value of TTBCR.N determine whether TTBR0 or TTBR1 is used as the translation table base register. The value of TTBCR.N indicates a number of most significant bits of the MVA and:

- if either TTBCR.N is zero or the indicated bits of the MVA are zero, TTBR0 is used
- otherwise TTBR1 is used.

For more information, see *Determining which TTBR to use, and the TTBR0 translation table size* on page B3-118.

The normal use of the two TTBRs is:

TTBR0 Typically used for process-specific addresses. This table ranges in size from 128bytes to 16Kbyte, depending on the value of TTBCR.N.

Each process maintains a separate first-level translation table. On a context switch:

- TTBR0 is updated to point to the first-level translation table for the new context
- TTBCR is updated if this change changes the size of the translation table
- the CONTEXTIDR is updated.

When the TTBCR is programmed to zero, all translations use TTBR0 in a manner compatible with earlier versions of the architecture, that is, with versions before ARMv6.

TTBR1 Typically used for operating system and I/O addresses, that do not change on a context switch. The size of this table is always 16KByte.

In the selected TTBR, the following bits define the memory region attributes for the translation table walk:

- the RGN, S and C bits, in the ARMv7-A base architecture
- the RGN, S, and IRGN[1:0] bits, when the Multiprocessing Extensions are implemented.

When the Security Extensions are implemented, two bits in the TTBCR for the current security state control whether a translation table walk is performed on a TLB miss:

- PD0, bit [4], controls whether translation table walks based on TTBR0 are performed
- PD1, bit [5], controls whether translation table walks based on TTBR1 are performed.

For more information about the TTBCR see *c2, Translation Table Base Control Register (TTBCR)* on page B3-117.

The effect of these bits is:

PDx == 0 When a TLB miss occurs based on TTBRx, a translation table walk is performed. The privilege of the memory access, Secure or Non-secure, corresponds to the current security state.

PDx == 1 If a TLB miss occurs based on TTBRx, a Section Translation fault is returned. No translation table walk is performed.

———— **Note** —————

When the Security Extensions are implemented, setting PD0 ==1 or PD1==1 can result in recursive entry into the abort handler. This effectively deadlocks the system if the mapping for the abort vectors is not guaranteed to be present in the TLB. TLB lockdown might be used to guarantee that the mapping for the abort vectors is present in the TLB.

B3.3.3 Translation table walks

A translation table walk occurs as the result of a TLB miss, and starts with a read of the appropriate first-level translation table:

- a section-mapped access only requires a read of the first-level translation table
- a page-mapped access also requires a read of the second-level translation table.

The value of the SCTL.R.EE bit determines the endianness of the translation table look ups. The physical address of the base of the first-level translation table is determined from the appropriate Translation Table Base Register (TTBR), see *Translation table base registers* on page B3-11.

In the base ARMv7 architecture, and in versions of the architecture before ARMv7, it is IMPLEMENTATION DEFINED whether a hardware translation table walk can cause a read from the L1 unified or data cache. If an implementation does not support translation table accesses from L1 then software must ensure coherency between translation table walks and data updates.

Typically this involves one of:

- storing translation tables in Inner Write-Through Cacheable Normal memory
- storing translation tables in Inner Write-Back Cacheable Normal memory and ensure the appropriate cache entries are cleaned after modification
- storing translation tables in Non-cacheable memory.

For more information, see *TLB maintenance operations and the memory order model* on page B3-59.

In the Multiprocessing Extensions, translation table walks are required to access data or unified caches, or data and unified caches, of other agents participating in the coherency protocol, according to the shareability attributes described in the translation table base register. The shareability attributes described in the translation table base register must be consistent with the shareability attributes for the translation tables themselves.

Reading a first-level translation table

To perform a fetch based on TTBR1, Bits TTBR1[31:14] are concatenated with bits [31:20] of the MVA and two zero bits to produce a 32-bit physical address, as shown in Figure B3-1.

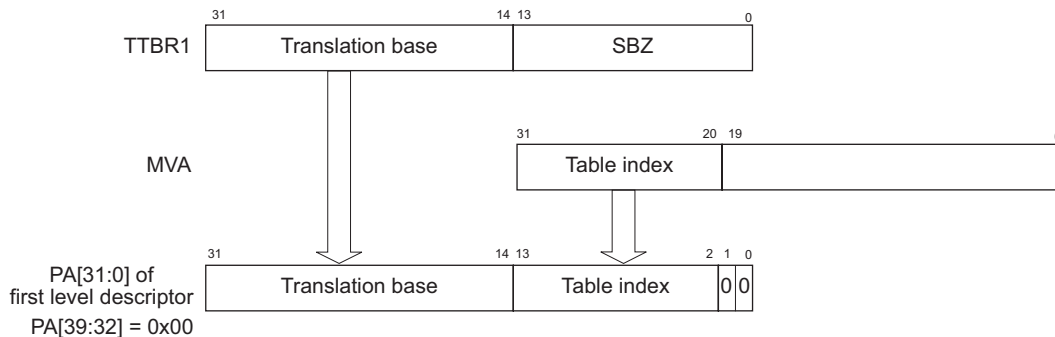

Figure B3-1 Accessing the translation table first-level descriptors based on TTBR1

When performing a fetch based on TTBR0:

- the address bits taken from TTBR0 vary between bits [31:14] and bits [31:7]
- the address bits taken from the MVA vary between bits [31:20] and bits [24:20].

The width of the TTBR0 and MVA fields depend on the value of TTBCR.N, as shown in Figure B3-2.

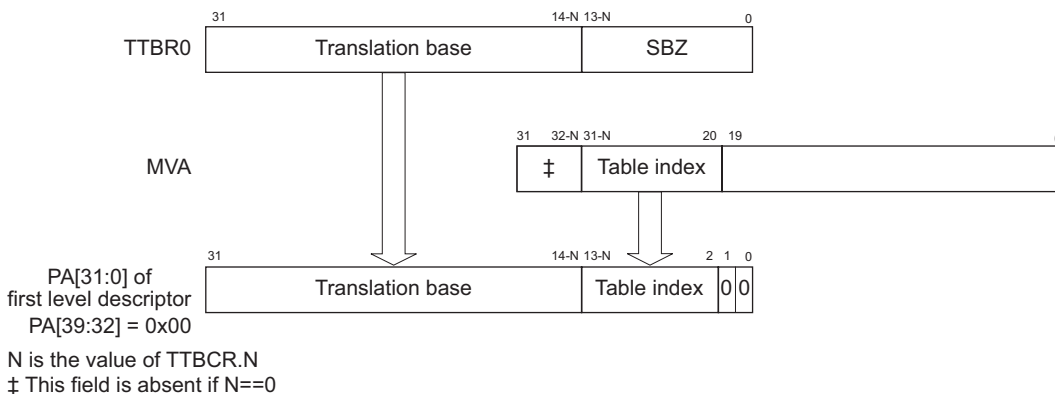

Figure B3-2 Accessing the translation table first-level descriptors based on TTBR0

Regardless of which register is used as the base for the fetch, the resulting physical address selects a four-byte translation table entry that is one of:

- A first-level descriptor for a Section or Supersection.
- A *Page table* pointer to a second-level translation table. In this case a second fetch is performed to retrieve a second-level descriptor, see *Reading a second-level translation table*.
- A faulting entry.

———— **Note** ————

Comparing Figure B3-1 on page B3-14 with Figure B3-2 on page B3-14, you can see that when using TTBR0 with $N == 0$ the construction of the PA becomes identical to that for TTBR1. Other diagrams in this section show the PA formation from TTBR0, but also represent PA formation from TTBR1, for which case $N = 0$.

Reading a second-level translation table

Figure B3-3 shows how the address of a second-level descriptor is obtained by combining:

- the result of the first-level fetch
- the second-level table index value held in bits [19:12] of the MVA.

See Table B3-1 on page B3-8 for the format of the Access control fields of the first-level descriptor.

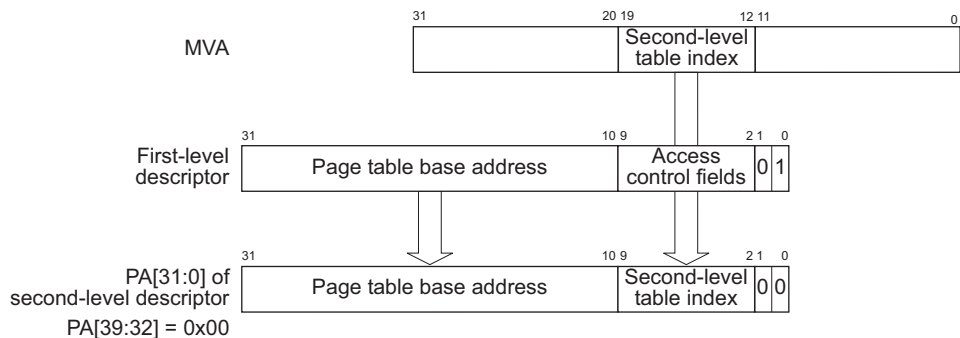

Figure B3-3 Accessing second-level Page table descriptors

The full translation flow for Sections, Supersections, Small pages and Large pages

This section summarizes how each of the memory section and page options is described in the translation tables, and has a subsection summarizing the full translation flow for each of the options.

The four options are:

Section A 1 MB memory region, described by a first-level translation table descriptor with bits [18,1:0] == 0b010.

See *Translation flow for a Section* on page B3-17.

Supersection A 16 MB memory region, described by a first-level translation table entry with bits [18,1:0] == 0b110.

See *Translation flow for a Supersection* on page B3-18.

Small page A 4 KB memory region, described by:

- a first-level translation table entry with bits [1:0] == 0b01, giving a second-level Page table address.
- a second-level descriptor with bit [1] == 1.

See *Translation flow for a Small page* on page B3-19.

Large page A 64 KB memory region, described by:

- a first-level translation table entry with bits [1:0] == 0b01, giving a second-level Page table address.
- a second-level descriptor with bits [1:0] == 0b01.

See *Translation flow for a Large page* on page B3-20.

Translation flow for a Section

Figure B3-4 shows the virtual to physical addresses translation for a Section. For details of the access control fields in the first-level descriptor see the *Section* entry in Table B3-1 on page B3-8.

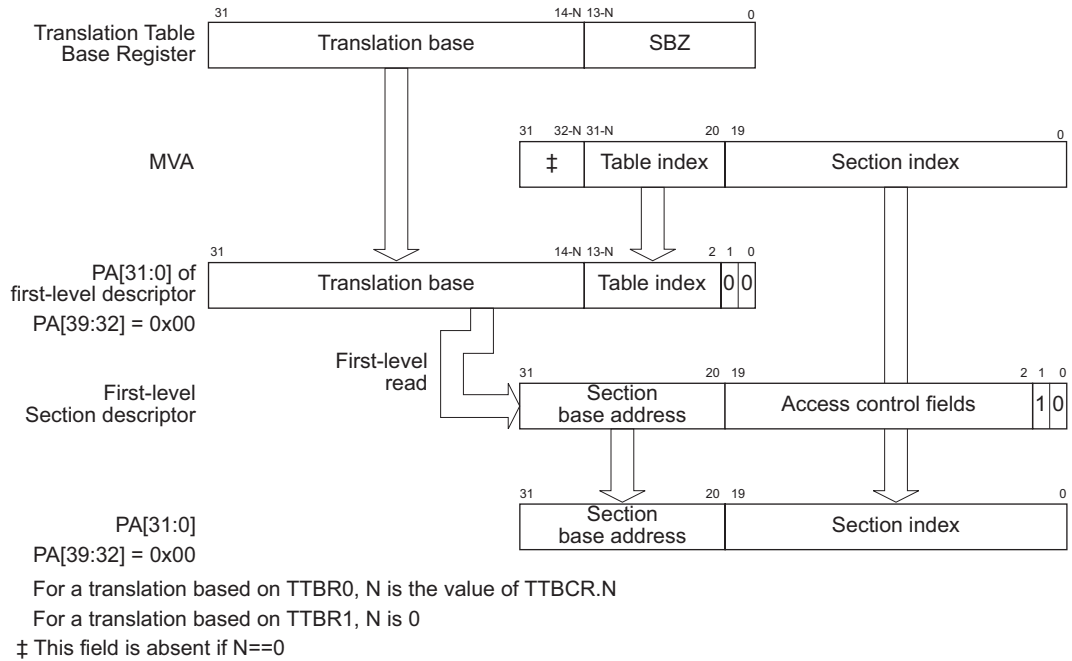
**Figure B3-4 Section address translation**

Translation flow for a Supersection

Figure B3-5 shows the virtual to physical addresses translation for a Supersection. For details of the extended Supersection address and access control fields in the first-level descriptor see the *Supersection* entry in Table B3-1 on page B3-8.

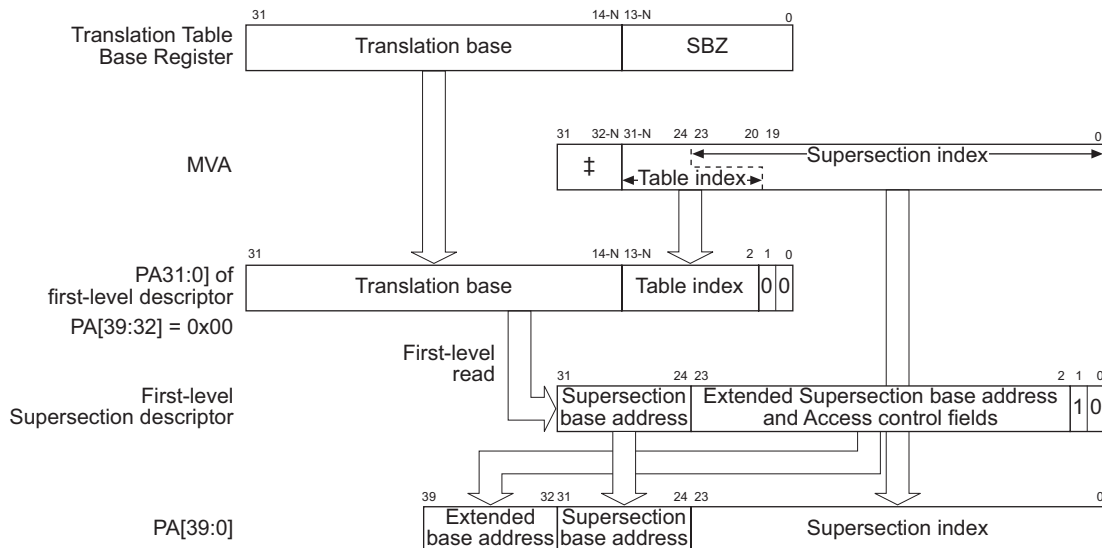

For a translation based on TTBR0, N is the value of TTBCR.N

For a translation based on TTBR1, N is 0

‡ This field is absent if N=0

Figure B3-5 Supersection address translation

Note

Figure B3-5 shows how, when the MVA addresses a Supersection, the top four bits of the *Supersection index* bits of the MVA overlap the bottom four bits of the *Table index* bits. For more information, see *Additional requirements for translation tables* on page B3-11.

Translation flow for a Small page

Figure B3-6 shows the virtual to physical addresses translation for a Small page. For details of the access control fields in the first-level descriptor see the *Page table* entry in Table B3-1 on page B3-8. For details of the access control fields in the second-level descriptor see the *Small page* entry in Table B3-2 on page B3-10.

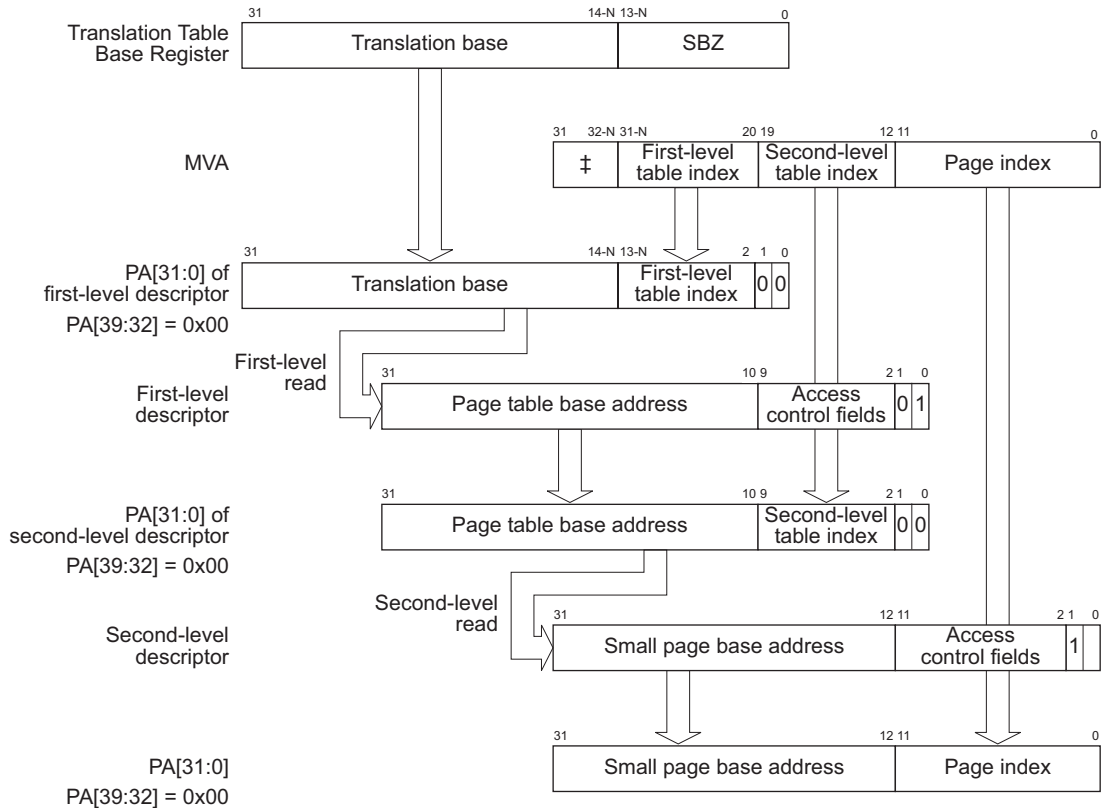

For a translation based on TTBR0, N is the value of TTBCR.N

For a translation based on TTBR1, N is 0

‡ This field is absent if N=0

Figure B3-6 Small page address translation

Translation flow for a Large page

Figure B3-7 shows the virtual to physical addresses translation for a Large page. For details of the access control fields in the first-level descriptor see the *Page table* entry in Table B3-1 on page B3-8. For details of the access control fields in the second-level descriptor see the *Large page* entry in Table B3-2 on page B3-10.

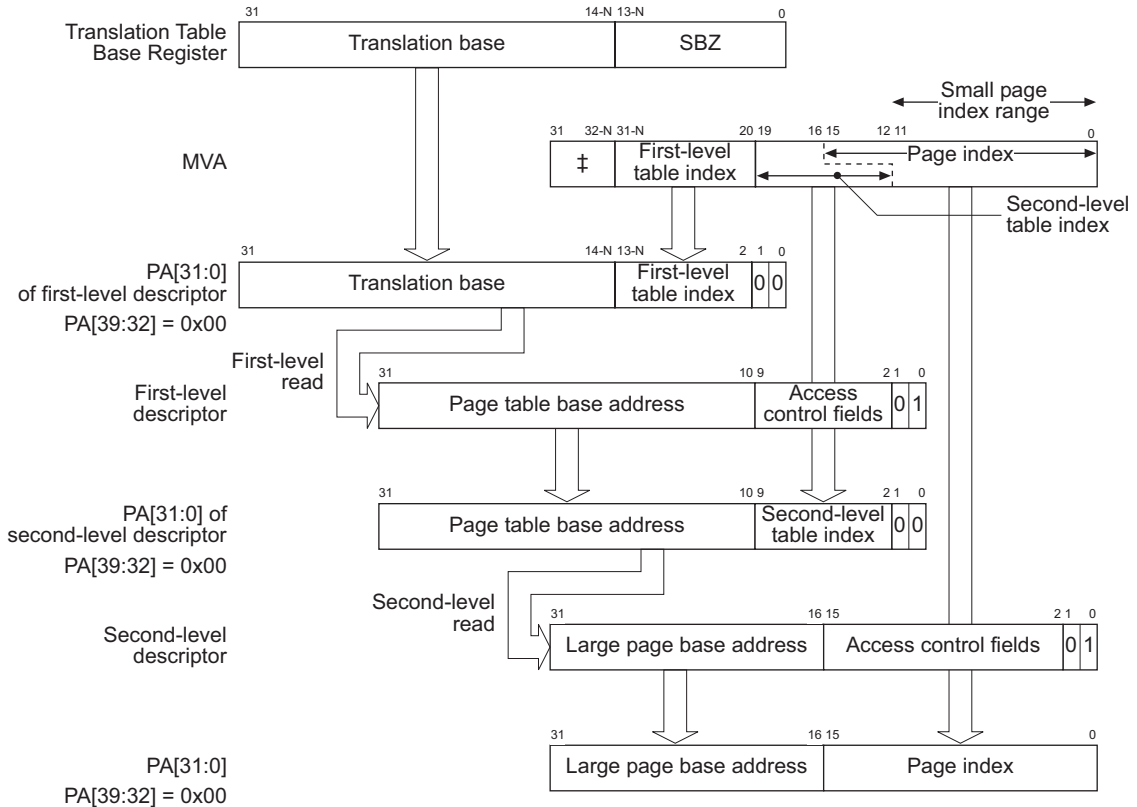

For a translation based on TTBR0, N is the value of TTBCR.N

For a translation based on TTBR1, N is 0

‡ This field is absent if N==0

Figure B3-7 Large page address translation

Note

Figure B3-7 shows how, when the MVA addresses a Large page, the top four bits of the *page index* bits of the MVA overlap the bottom four bits of the *First-level table index* bits. For more information, see *Additional requirements for translation tables* on page B3-11. This diagram also shows the width of the *page index* bits when addressing a Small page, to show that there is no overlap in this case.

B3.3.4 Changing translation table attributes

When changing translation table attributes, you must avoid situations where caching or pipelining effects mean that overlapping entries or aliases with different attributes might be visible to the processor at the same time. To avoid these situations, ARM recommends that you invalidate old translation table entries, and synchronize the effects of those invalidations, before you create new translation table entries that might overlap or create aliases with different attributes. This approach is sometimes called *break before make*.

For information about the procedure for synchronizing a change to the translation tables see *TLB maintenance operations and the memory order model* on page B3-59.

Translation table entries that create Translation faults are not held in the TLB, see *Translation fault* on page B3-43. Therefore TLB and branch predictor invalidation is not required for the synchronization of a change from a translation table entry that causes a Translation fault to one that does not.

B3.3.5 The access flag

From VMSAv7, the AP[0] bit in the translation table descriptors can be redefined as an access flag. This is done by setting SCTL.R.AFE to 1, see *c1, System Control Register (SCTLR)* on page B3-96. When this bit is set, the access permissions information in the translation table descriptors is limited to the AP[2:1] bits, as described in *Simplified access permissions model* on page B3-29.

The access flag is used to indicate when a page or section of memory is accessed for the first time since the access flag was set to 0.

It is IMPLEMENTATION DEFINED whether the access flag is managed by software or by hardware. The two options are described in the subsections:

- *Software management of the access flag*
- *Hardware management of the access flag.*

The access flag mechanism expects that, when an Access Flag fault occurs, software sets the access flag to 1 in the translation table entry that caused the fault. This prevents the fault occurring the next time the memory is accessed. Software does not have to flush the entry from the TLB after setting the flag.

Software management of the access flag

With an implementation that requires software to manage the access flag, an Access Flag fault is generated when both:

- the SCTL.R.AFE bit is set to 1
- a translation table entry with the access flag set to 0 is read into the TLB.

Hardware management of the access flag

An implementation can choose to provide hardware management of the access flag. In this case, when the SCTL.R.AFE bit is set to 1 and a translation table entry with the access flag set to 0 is read into the TLB, the hardware must write 1 to the access flag bit of the translation table entry in memory.

Any implementation of hardware management of the access flag must ensure that any software changes to the translation table are not lost. The architecture does not require software that performs translation table changes to use interlocked operations. The hardware management mechanisms for the access flag must prevent any loss of data written to translation table entries that might occur when, for example, a write by another processor occurs between the read and write phases of a translation table walk that updates the access flag.

An implementation that provides hardware management of the access flag:

- does not generate Access Flag faults when the access flag is enabled
- uses the HW access flag field, `ID_MMFR2[31:28]`, to indicate this implementation choice, see *c0, Memory Model Feature Register 2 (ID_MMFR2)* on page B5-14.

Architecturally, an operating system that makes use of the access flag must support the software faulting option that uses the Access Flag fault. This provides compatibility between systems that include a hardware implementation of the access flag and those systems that do not implement this feature.

When an implementation provides hardware management of the access flag it must also implement the `SCTLR.HA` bit, that can be used to enable or disable the access flag mechanism. See *c1, System Control Register (SCTLR)* on page B3-96.

Changing the access flag enable

It is UNPREDICTABLE whether the TLB caches the effect of the `SCTLR.AFE` bit on translation tables. This means that, after changing the `SCTLR.AFE` bit software must invalidate the TLB before it relies on the effect of the new value of the `SCTLR.AFE` bit.

B3.4 Address mapping restrictions

ARMv6 supported a *page coloring* restriction that, when implemented, required all Virtual Address aliases of a given Physical Address to have the same value for address bits [13:12]. This page coloring restriction was required to support *Virtually Index Physically Tagged* (VIPT) caches with a cache way size larger than 4KBytes. For details of the page coloring restriction see *Virtual to physical translation mapping restrictions* on page AppxG-26.

ARMv7 does not support page coloring, and requires that all data and unified caches behave as *Physically Indexed Physically Tagged* (PIPT) caches.

Note

An ARMv7 implementation might use techniques such as hardware alias avoidance to make a VIPT cache behave as a PIPT cache, and might improve performance by avoiding accesses to frequently alternating aliases to a physical address. Such approaches give good results, but ARM recommends migration to the use of true PIPT caches for all data and unified caches.

In an ARMv7 implementation, any data or unified cache maintenance operation that operates on a virtual address must take account of the fact that the cache behaves as a PIPT cache. This means that the implementation must perform the appropriate action on the physical address that corresponds to the MVA targeted by the operation.

The ARMv7 requirements for instruction caches are described in *Requirements for instruction caches*.

B3.4.1 Requirements for instruction caches

In a base VMSAv7 implementation, the following conditions require cache maintenance of an instruction cache:

- writing new data to an instruction address
- writing new address mappings to the translation table
- changing one or more of the TTBR0, TTBR1 and TTBCR registers without changing the ASID
- enabling or disabling the MMU, by writing to the SCTLR.

Note

These conditions are consistent with the maintenance required for an ASID-tagged Virtually Indexed Virtually Tagged (VIVT) instruction cache that also includes a security status bit for each cache entry.

VMSAv7 can be implemented with an optional extension, the *IVIPT extension* (Instruction cache Virtually Indexed Physically Tagged extension). The effect of this extension is to reduce the instruction cache maintenance requirement to a single condition:

- writing new data to an instruction address.

Note

This condition is consistent with the maintenance required for a Virtually Indexed Physically Tagged (VIPT) instruction cache.

Software can read the Cache Type Register to determine whether the IVIPT extension is implemented, see *c0, Cache Type Register (CTR)* on page B3-83.

Functionally, the relationship between cache type and the software management requirement depends on whether the operating system uses ASIDs to distinguish processes that use different translation tables:

- when ASIDs are used, management is similar for a VIPT and an ASID-tagged VIVT cache
- when ASIDs are not used, management is similar for a VIVT and an ASID-tagged VIVT cache.

A remapping policy that supports ASID changes means that translation tables can be swapped simply by updates to the TTBR0, TTBR1 and TTBCR registers, with an appropriate change of the ASID held in the CONTEXTIDR, see *Synchronization of changes of ASID and TTBR* on page B3-60. Such changes are transparent to an ASID-tagged VIVT instruction cache until an ASID value is reused. In contrast, a VIVT instruction cache that is not ASID-tagged must be invalidated whenever the virtual to physical address mappings change. Therefore, such a cache must be invalidated on an ASID change.

Software written to rely on a VIPT instruction cache must only be used with processors that implement the IVIPT. For maximum compatibility across processors, ARM recommends that operating systems target the ARMv7 base architecture that uses ASID-tagged VIVT instruction caches, and do not assume the presence of the IVIPT extension. Software that relies on the IVIPT extension might fail in an UNPREDICTABLE way on an ARMv7 implementation that does not include the IVIPT extension.

With an instruction cache, the distinction between a VIPT cache and a PIPT cache is much less visible to the programmer than it is for a data cache, because normally the contents of an instruction cache are not changed by writing to the cached memory. However, there are situations where a program must distinguish between the different cache tagging strategies. Example B3-1 describes such a situation.

Example B3-1 A situation where software must be aware of the Instruction cache tagging strategy

Two processes, P_1 and P_2 , share some code and have separate virtual mappings to the same region of instruction memory. P_1 changes this region, for example as a result of a JIT, or some other self-modifying code operation. P_2 needs to see the modified code.

As part of its self-modifying code operation, P_1 must invalidate the changed locations from the instruction cache. For more information, see *Ordering of cache and branch predictor maintenance operations* on page B2-21. If this invalidation is performed by MVA, and the instruction cache is a VIPT cache, then P_2 might continue to see the old code.

In this situation, if the instruction cache is a VIPT cache, after the code modification the entire instruction cache must be invalidated to ensure P_2 observes the new version of the code.

Note

Software can read the Cache Type Register to determine whether the instruction cache is PIPT, VIPT, or ASID-tagged VIVT, see *c0, Cache Type Register (CTR)* on page B3-83.

B3.4.2 Instruction cache maintenance operations by MVA

~~On a cache maintenance operation by MVA, the generation of Data Abort exceptions can depend on the tagging strategy of the instruction cache:~~

- ~~• With an ASID-tagged VIVT instruction cache, it is IMPLEMENTATION-DEFINED whether the TLB is checked to see whether a valid translation table mapping exists for the VA used by a cache maintenance operation. Therefore, it is IMPLEMENTATION-DEFINED whether cache maintenance operations by MVA can generate Data Abort exceptions.~~
- ~~• With a VIPT or PIPT instruction cache, the TLB must be checked and an abort is generated on a Translation fault or an Access Flag fault. No abort is generated on a Domain or Permission fault.~~

For maximum portability, ARM recommends that operating systems always provide an abort handler to process Data Abort exceptions on instruction cache maintenance operations by MVA, even though some ARMv7 implementations might not be capable of generating these aborts.

The effect of an instruction cache maintenance operation by MVA can depend on the tagging strategy of the instruction cache:

- For an ASID-tagged VIVT instruction cache or a VIPT instruction cache, the effect of the operation is only guaranteed to apply to the modified virtual address supplied to the instruction. It is not guaranteed to apply to any other alias of that modified virtual address.
- For a PIPT instruction cache, the effect of the operation applies to all aliases of the modified virtual address supplied to the instruction.

B3.5 Secure and Non-secure address spaces

When implemented, the Security Extensions provide two physical address spaces, a Secure physical address space and a Non-secure physical address space.

The translation table base registers, TTBR0, TTBR1 and TTBCR are banked between Secure and Non-secure versions, and the security state of a memory access selects the corresponding version of the registers. Therefore, the translation tables are separated between Secure and Non-secure versions. Translation table walks are made to the physical address space corresponding to the security state of the translation tables.

The Non-secure translation table entries can only translate a virtual address to a physical address in the Non-secure physical address space. Secure translation table entries can translate a virtual address to a physical addresses in either the Secure or the Non-secure address space. Selection of which physical address space to use is managed by the NS field in the first-level descriptors, see *First-level descriptors* on page B3-8:

- for Non-secure translation table entries, the NS field is ignored
- for Secure translation table entries, the NS field determines which physical address space is accessed:
NS == 0 Secure physical address space is accessed.
NS == 1 Non-secure physical address space is accessed.

Because the NS field is defined only in the first level translation tables, the granularity of the Secure and Non-secure memory spaces is 1MB. However, in these memory regions you can define physical memory regions with a granularity of 4KB. For more information, see *Translation tables* on page B3-7.

————— **Note** —————

A system implementation can alias parts of the Secure physical address space to the Non-secure physical address space in implementation-specific ways. As with any other aliasing of physical memory, the use of aliases in this way can require the use of cache maintenance operations to ensure that changes to memory made using one alias of the physical memory are visible to accesses to the other alias of the physical memory.

B3.5.1 The effect of the Security Extensions on the cache operations

When the Security Extensions are implemented and each security state has its own physical address space, Table B3-3 shows the effect of the security state on the cache operations.

Table B3-3 Effect of the security state on the cache operations

Cache operation	Security state	Targeted entry
Instruction cache operations		
Invalidate All	Non-secure	All instruction cache lines that contain entries that can be accessed from the Non-secure security state
Invalidate All	Secure	All instruction cache lines
Invalidate by MVA	Either	Base Architecture: All Lines that match the specified MVA and the current ASID and come from the same virtual address space as the current security state
		IVIPT extension: ^a All Lines that match the specified MVA and the current ASID and come from the same physical address space as described in the translation tables
Data or unified cache operations		
Invalidate, Clean, Clean and Invalidate by set/way	Non-secure	Line specified by set/way provided that the entry comes from the Non-secure physical address space
Invalidate, Clean, Clean and Invalidate by set/way	Secure	Line specified by set/way regardless of the physical address space that the entry has come from
Invalidate, Clean, Clean and Invalidate by MVA	Either	All Lines that match the specified MVA and the current ASID and come from the same physical address space, as described in the translation tables

a. For more information about the IVIPT extension see *Requirements for instruction caches* on page B3-23.

For locked entries and entries that might be locked, the behavior of cache maintenance operations described in *The interaction of cache lockdown with cache maintenance* on page B2-18 applies. This behavior is not affected by the Security Extensions.

With an implementation that generates aborts if entries are locked or might be locked in the cache, if the use of lockdown aborts is enabled then these aborts can occur on any cache maintenance operation regardless of the Security Extensions.

B3.6 Memory access control

Access to a memory region is controlled by the access permission bits and the domain field in the TLB entry. These form part of the translation table entry formats described in *Translation tables* on page B3-7. The bits and fields are summarized in *First-level descriptors* on page B3-8 and *Second-level descriptors* on page B3-10.

The TLB memory access controls are described in:

- *Access permissions*
- *The Execute Never (XN) attribute and instruction prefetching* on page B3-30
- *Domains* on page B3-31.

B3.6.1 Access permissions

The access permission bits control access to the corresponding memory region. If an access is made to an area of memory without the required permissions, a Permission fault is generated if the domain is set to Client. The access permissions are determined by the AP[2:0] bits in the translation table entry. The XN bit in the translation table entry provides an additional permission bit for instruction fetches.

Note

- Before VMSAv7, the SCTL.R and SCTL.S bits also affect the access permissions. For more information, see *Translation attributes* on page AppxH-22.
- From VMSAv7, the full set of access permissions shown in Table B3-4 are only supported when the SCTL.AFE bit is set to 0. When SCTL.AFE = 1, the only supported access permissions are those described in *Simplified access permissions model* on page B3-29.
- In previous issues of the *ARM Architecture Reference Manual* and in some other documentation, the AP[2] bit in the translation table entries is described as the APX bit.

Table B3-4 shows the encoding of the access permissions:

Table B3-4 VMSAv7 MMU access permissions

AP[2]	AP[1:0]	Privileged permissions	User permissions	Description
0	00	No access	No access	All accesses generate Permission faults
0	01	Read/write	No access	Privileged access only
0	10	Read/write	Read-only	Writes in User mode generate Permission faults
0	11	Read/write	Read/write	Full access
1	00	-	-	Reserved

Table B3-4 VMSAv7 MMU access permissions (continued)

AP[2]	AP[1:0]	Privileged permissions	User permissions	Description
1	01	Read-only	No access	Privileged read-only
1	10	Read-only	Read-only	Privileged and User read-only, deprecated in VMSAv7 ^a
1	11	Read-only	Read-only	Privileged and User read-only ^b

- a. From VMSAv7, ARM strongly recommends that the 0b11 encoding is used for Privileged and User read-only.
b. This mapping is introduced in VMSAv7, and is reserved in VMSAv6. For more information, see *Simplified access permissions model*.

Each memory region can be tagged as not containing executable code. If the *Execute-never* (XN) bit is set to 1 and the region is in a Client domain, any attempt to execute an instruction in that region results in a Permission fault. If the XN bit is 0 and there is valid read permission, code can execute from that memory region, provided that no other Prefetch Abort condition exists.

———— **Note** —————

The XN bit is ignored on accesses to Manager domains.

Simplified access permissions model

Some memory management require a simple access permissions model where:

- one flag selects between read-only and read/write access
- a second flag selects between User and Kernel control.

In the ARM architecture, this model permits four access combinations:

- read-only by both privileged and unprivileged code
- read/write by both privileged and unprivileged code
- read-only by privileged code, no access by unprivileged code
- read/write by privileged code, no access by unprivileged code.

With the VMSAv7 MMU access permissions shown in Table B3-4 on page B3-28, this model is implemented by:

- Setting the AP[0] bit to 1, unless the SCTLRAFE bit is set to 1, see *c1, System Control Register (SCTLR)* on page B3-96.
- Using the AP[2:1] bits to control access, as shown in Table B3-5 on page B3-30.

Table B3-5 VMSAv7 simple access control model

AP[2]	AP[1]	Access ^a
0	0	Kernel, read/write
0	1	User, read/write
1	0	Kernel, read-only
1	1	User, read-only

a. Kernel access corresponds to access by privileged code only.

Note

This model depends on the definition of the AP[2] == 1, AP[1:0] == 0b11 encoding shown in Table B3-4 on page B3-28. This encoding is introduced in VMSAv7, and therefore the simplified access permissions model cannot be supported in VMSAv6.

When the SCTL.R.AFE bit is set to 1 the AP[0] bit becomes an access flag, see *The access flag* on page B3-21. In this case, this simplified access permissions model becomes the only supported access permissions model.

B3.6.2 The Execute Never (XN) attribute and instruction prefetching

An implementation must not fetch instructions from any memory location that is marked as Execute Never. A location is marked as Execute Never when it has its XN attribute set to 1 in a Client domain. When the MMU is enabled, instructions can only be fetched or prefetched from memory locations in Client domains where:

- XN is set to 0
- valid read permissions exist
- no other Prefetch Abort condition exists.

Any region of memory that is read-sensitive must be marked as Execute Never, to avoid the possibility of a speculative prefetch accessing the memory region. For example, any memory region that corresponds to a read-sensitive peripheral must be marked as Execute Never.

The XN attribute is not checked for domains marked as Manager. Read-sensitive memory must not be included in domains marked as Manager, because the XN bit does not prevent prefetches in these cases.

The XN attribute is not checked when the MMU is disabled. All VMSAv7 implementations must ensure that, when the MMU is disabled, prefetching down non-sequential paths cannot cause unwanted accesses to read-sensitive devices.

B3.6.3 Domains

A domain is a collection of memory regions. The ARM VMSA architecture supports 16 domains, and each VMSA memory region is assigned to a domain:

- First-level translation table entries for Page tables and Sections include a domain field.
- Translation table entries for Supersections do not include a domain field. Supersections are defined as being in domain 0.
- Second-level translation table entries inherit a domain setting from the parent first-level Page table entry.
- Each TLB entry includes a domain field.

A domain field specifies which domain the entry is in. Access to each domain is controlled by a two-bit field in the Domain Access Control Register, see *c3, Domain Access Control Register (DACR)* on page B3-119. Each field enables the access to an entire domain to be enabled and disabled very quickly, so that whole memory areas can be swapped in and out of virtual memory very efficiently. The VMSA supports two kinds of domain access:

Clients Users of domains, guarded by the access permissions of the TLB entries for that domain. Clients execute programs and access data held in the domain.

Managers Control the behavior of the domain, and are not guarded by the access permissions for TLB entries in that domain. The domain behavior controlled by a Manager covers:

- the sections and pages currently in the domain
- the current access permissions for the domain.

A single program might:

- be a Client of some domains
- be a Manager of some other domains
- have no access to the remaining domains.

This permits very flexible memory protection for programs that access different memory resources. Table B3-6 shows the encoding of the bits in the DACR.

Table B3-6 Domain access values

Value	Access types	Description
00	No access	Any access generates a Domain fault
01	Client	Accesses are checked against the access permission bits in the TLB entry
10	Reserved	Using this value has UNPREDICTABLE results
11	Manager	Accesses are not checked against the access permission bits in the TLB entry, so a Permission fault cannot be generated

B3.7 Memory region attributes

Each TLB entry has an associated set of memory region attributes. These control accesses to the caches, how the write buffer is used, and if the memory region is Shareable and therefore must be kept coherent. From VMSAv6:

- Most of the memory attributes are controlled by the C and B bits and the TEX[2:0] field of the translation table entries. More information about these attributes is given in the sections:
 - *The alternative descriptions of the Memory region attributes*
 - *C, B, and TEX[2:0] encodings without TEX remap* on page B3-33
 - *Memory region attribute descriptions when TEX remap is enabled* on page B3-34.
- When the Security Extensions are implemented, the NS bit provides an additional memory attribute, see *Secure and Non-secure address spaces* on page B3-26.

———— Note —————

The *Bufferable* (B), *Cacheable* (C), and *Type Extension* (TEX) bit names are inherited from earlier versions of the architecture. These names no longer adequately describe the function of the B, C, and TEX bits.

The translation table entries also include an S bit. This bit:

- Is ignored if the entry refers to Device or Strongly-ordered memory.
- For Normal memory, determines whether the memory region is Shareable or Non-shareable:
 - S == 0 Normal memory region is Non-shareable
 - S == 1 Normal memory region is Shareable.

B3.7.1 The alternative descriptions of the Memory region attributes

From VMSAv7, there are two alternative schemes for describing the memory region attributes, and the current scheme is selected by the SCTLR.TRE (TEX Remap Enable) bit, see *c1, System Control Register (SCTLR)* on page B3-96. The two schemes are:

- TRE == 0** TEX Remap disabled. TEX[2:0] are used, with the C and B bits, to describe the memory region attributes.
- This is the scheme used in VMSAv6, and it is described in *C, B, and TEX[2:0] encodings without TEX remap* on page B3-33.
- TRE == 1** TEX Remap enabled. TEX[2:1] are reassigned for use as flags managed by the operating system. The TEX[0], C and B bits are used to describe the memory region attributes, with the MMU remap registers:
- the Primary Region Remap Register, PRRR
 - the Normal Memory Remap Register, NMRR.
- This scheme is described in *Memory region attribute descriptions when TEX remap is enabled* on page B3-34.

When the Security Extensions are implemented, the SCTLR.TRE bit is banked between the Secure and Non-secure states.

B3.7.2 C, B, and TEX[2:0] encodings without TEX remap

Table B3-7 shows the C, B, and TEX[2:0] encodings when TEX remap is disabled (TRE == 0).

Table B3-7 TEX, C, and B encodings when TRE == 0

TEX[2:0]	C	B	Description	Memory type	Page Shareable
000	0	0	Strongly-ordered	Strongly-ordered	Shareable
000	0	1	Shareable Device	Device	Shareable
000	1	0	Outer and Inner Write-Through, no Write-Allocate	Normal	S bit ^a
000	1	1	Outer and Inner Write-Back, no Write-Allocate	Normal	S bit ^a
001	0	0	Outer and Inner Non-cacheable	Normal	S bit ^a
001	0	1	Reserved	-	-
001	1	0	IMPLEMENTATION DEFINED	IMPLEMENTATION DEFINED	IMPLEMENTATION DEFINED
001	1	1	Outer and Inner Write-Back, Write-Allocate	Normal	S bit ^a
010	0	0	Non-shareable Device	Device	Non-shareable
010	0	1	Reserved	-	-
010	1	X	Reserved	-	-
011	X	X	Reserved	-	-
1BB	A	A	Cacheable memory: AA = Inner attribute ^b BB = Outer attribute	Normal	S bit ^a

- Whether the memory is Shareable depends on the value of the S bit, see description in *Memory region attributes* on page B3-32.
- For more information, see *Cacheable memory attributes* on page B3-34.

See *Memory types and attributes and the memory order model* on page A3-24 for an explanation of Normal, Strongly-ordered and Device memory types and of the Shareable attribute.

Cacheable memory attributes

When $\text{TEX}[2] == 1$, the translation table entry describes Cacheable memory, and the rest of the encoding defines the Inner and Outer cache attributes:

TEX[1:0] defines the Outer cache attribute

C,B defines the Inner cache attribute

The same encoding is used for the Outer and Inner cache attributes. Table B3-8 shows the encoding.

Table B3-8 Inner and Outer cache attribute encoding

Encoding		Cache attribute
0	0	Non-cacheable
0	1	Write-Back, Write-Allocate
1	0	Write-Through, no Write-Allocate
1	1	Write-Back, no Write-Allocate

B3.7.3 Memory region attribute descriptions when TEX remap is enabled

The VMSAv6 scheme for describing the memory region attributes, described in *C*, *B*, and *TEX[2:0]* encodings without *TEX* remap on page B3-33, uses the *TEX[2:0]*, *C* and *B* bits to describe all of the options for Inner and Outer cacheability. However, many system software implementations do not need to use all of these options simultaneously. Instead a smaller subset of attributes can be enabled. This alternative functionality is called *TEX* remap, and permits software to hold software-interpreted values in the translation tables. When *TEX* remap is enabled:

- only the *TEX[0]*, *C* and *B* bits are used to describe the memory region attributes
- fewer attribute options are available at any time
- the available options are configurable using the *PRRR* and *NMRR* registers
- *TEX[2:1]* are not updated by hardware, see *The OS managed translation table bits* on page B3-38.

When *TEX* remap is enabled:

- For seven of the eight possible combinations of the *TEX[0]*, *C* and *B* bits:
 - a field in the *PRRR* defines the corresponding memory region as being Normal, Device or Strongly-ordered memory
 - a field in the *NMRR* defines the Inner cache attributes that apply if the *PRRR* field identifies the region as Normal memory
 - a second field in the *NMRR* defines the Outer cache attributes that apply if the *PRRR* field identifies the region as Normal memory.
- The meaning of the eighth combination for the *TEX[0]*, *C* and *B* bits is IMPLEMENTATION DEFINED

- Four bits in the PRRR permit mapping of the Shareable attribute by defining, for the translation table S bit:
 - the meaning of S == 0 if the region is identified as Device memory
 - the meaning of S == 1 if the region is identified as Device memory
 - the meaning of S == 0 if the region is identified as Normal memory
 - the meaning of S == 1 if the region is identified as Normal memory.
 In each case, the meaning of the Shareable bit value is that the memory region is one of:
 - Shareable
 - Non-shareable.

For each of the possible encodings of the TEX[0], C and B bits in a translation table entry, Table B3-9 shows which fields of the PRRR and NMRR registers describe the memory region attributes.

Table B3-9 TEX, C, and B encodings when TRE == 1

Encoding TEX[0]	C	B	Memory type ^a	Cache attributes ^{a, b:}		Outer Shareable attribute ^b
				Inner cache	Outer cache	
0	0	0	PRRR[1:0]	NMRR[1:0]	NMRR[17:16]	NOT(PRRR[24])
0	0	1	PRRR[3:2]	NMRR[3:2]	NMRR[19:18]	NOT(PRRR[25])
0	1	0	PRRR[5:4]	NMRR[5:4]	NMRR[21:20]	NOT(PRRR[26])
0	1	1	PRRR[7:6]	NMRR[7:6]	NMRR[23:22]	NOT(PRRR[27])
1	0	0	PRRR[9:8]	NMRR[9:8]	NMRR[25:24]	NOT(PRRR[28])
1	0	1	PRRR[11:10]	NMRR[11:10]	NMRR[27:26]	NOT(PRRR[29])
1	1	0	IMPLEMENTATION DEFINED	IMPLEMENTATION DEFINED	IMPLEMENTATION DEFINED	IMPLEMENTATION DEFINED
1	1	1	PRRR[15:14]	NMRR[15:14]	NMRR[31:30]	NOT(PRRR[31])

- For details of the memory type field encodings see *c10, Primary Region Remap Register (PRRR)* on page B3-143. For details of the cache attribute encodings see Table B3-8 on page B3-34.
- Only applies if the memory type for the region is mapped as Normal memory and the location is Shareable.

To find the meaning of the value of the S bit in a translation table entry you must:

- use Table B3-9 to find the memory type of the region described by the entry
- if the memory type is Strongly-ordered then the region is Shareable
- if the memory type is not Strongly-ordered then look up the memory type and value of the S bit in Table B3-10 on page B3-36 to find which bit of the PRRR defines the Shareable attribute of the region.

Table B3-10 Remapping of the S bit

Memory type	Remapping of Shareable attribute when	
	S = 0	S = 1
Strongly-ordered	Shareable ^a	Shareable ^a
Device	PRRR[16]	PRRR[17]
Normal	PRRR[18]	PRRR[19]

a. No remapping, Strongly-ordered memory is always Shareable.

- The appropriate bit of the PRRR indicates whether the region is Shareable or Non-shareable.

Note

When TEX remapping is enabled, it is possible for a translation table entry with S = 0 to be mapped as Shareable memory.

For full descriptions of the TEX remap registers see:

- c10, Primary Region Remap Register (PRRR)* on page B3-143
- c10, Normal Memory Remap Register (NMRR)* on page B3-146.

When the Security Extensions are implemented, the TEX remap registers and the SCTL.RTRE bit are banked between the Secure and Non-secure security states. For more information, see *The effect of the Security Extensions on TEX remapping* on page B3-39.

When TEX remap is enabled, the mappings specified by the PRRR and NMRR determine the mapping of the TEX[0], C and B bits in the translation tables to memory type and cacheability attributes:

- The primary mapping, indicated by a field in the PRRR as shown in the Memory region column of Table B3-9 on page B3-35, takes precedence.
- Any region that is mapped as Normal memory can have the Inner and Outer Cacheable attributes determined by the NMRR.
- If it is supported, the Outer Shareable mapping ~~adds a third level of attribute~~, see *Interpretation of the NOSn fields in the PRRR* on page B3-37.

The TEX remap registers must be static during normal operation. In particular, when the remap registers are changed:

- it is IMPLEMENTATION DEFINED when the changes take effect
- it is UNPREDICTABLE whether the TLB caches the effect of the TEX remap on translation tables.

The sequence to ensure the synchronization of changes to the TEX remap registers is:

1. Perform a DSB. This ensures any memory accesses using the old mapping have completed.
2. Write the TEX remap registers or SCTL.R.TRE bit.
3. Perform an ISB. This ensures synchronization of the register updates.
4. Invalidate the entire TLB.
5. Perform a DSB. This ensures completion of the entire TLB operation.
6. Clean and invalidate all caches. This removes any cached information associated with the old mapping.
7. Perform a DSB. This ensures completion of the cache maintenance.
8. Perform an ISB. This ensures instruction synchronization.

This extends the standard rules for the synchronization of changes to CP15 registers described in *Changes to CP15 registers and the memory order model* on page B3-77, and provides implementation freedom as to whether or not the effect of the TEX remap is cached.

Interpretation of the NOSn fields in the PRRR

When all of the following apply, the NOSn fields in the PRRR distinguish between Inner Shareable and Outer Shareable memory regions:

- the SCTL.R.TRE bit is set to 1
- the region is mapped as Normal memory
- the Normal memory remapping of the S bit value for the entry makes the region Shareable
- the implementation supports the distinction between Inner Shareable and Outer Shareable.

If the SCTL.R.TRE bit is set to 0, an implementation can provide an IMPLEMENTATION DEFINED mechanism to interpret the NOSn fields in the PRRR, see *SCTL.R.TRE*, *SCTL.R.M*, and *the effect of the MMU remap registers* on page B3-38.

The values of the NOSn fields in the PRRR have no effect if any of the following apply:

- the SCTL.R.TRE bit is set to 0 and the IMPLEMENTATION DEFINED mechanism has not been invoked
- the region is not mapped as Normal memory
- the Normal memory remapping of the S bit value for the entry makes the region Non-shareable.

The NOSn fields in the PRRR are RAZ/WI if the implementation does not support the distinction between Inner Shareable and Outer Shareable memory regions.

SCTLR.TRE, SCTLR.M, and the effect of the MMU remap registers

When TEX remap is disabled, because the SCTLR.TRE bit is set to 0:

- the effect of the MMU remap registers can be IMPLEMENTATION DEFINED
- the interpretation of the fields of the PRRR and NMRR registers can differ from the description given in this section.

VMSAv7 requires that the effect of these registers is limited to remapping the attributes of memory locations. These registers must not change whether any cache or MMU hardware is enabled. The mechanism by which the MMU remap registers have an effect when the SCTLR.TRE bit is set to 0 is IMPLEMENTATION DEFINED. The ARMv7 architecture requires that from reset, if the IMPLEMENTATION DEFINED mechanism has not been invoked:

- If the MMU is enabled, the architecturally-defined behavior of the TEX[2:0], C, and B bits must apply, without reference to the TEX remap functionality. In other words, memory attribute assignment must comply with the scheme described in *C, B, and TEX[2:0] encodings without TEX remap* on page B3-33.
- If the MMU is disabled, then the architecturally-defined behavior of the VMSA with the MMU disabled must apply, without reference to the TEX remap functionality. See *Enabling and disabling the MMU* on page B3-5.

Typical mechanisms for enabling the IMPLEMENTATION DEFINED effect of the TEX Remap registers when SCTLR.TRE bit is set to 0 include:

- a control bit in the ACTLR, or in a CP15 c15 register
- changing the behavior when the PRRR and NMRR registers are changed from their IMPLEMENTATION DEFINED reset values.

In addition, if the MMU is disabled and the SCTLR.TRE bit is set to 1, the architecturally-defined behavior of the VMSA with the MMU disabled must apply without reference to the TEX remap functionality.

When the Security Extensions are implemented, the IMPLEMENTATION DEFINED effect of these registers must only take effect in the security domain of the registers.

The OS managed translation table bits

When TEX remap is enabled, the TEX[2:1] bits in the translation table descriptors are available as two flags that can be managed by the operating system. In VMSAv7, as long as the SCTLR.TRE bit is set to 1, the values of the TEX[2:1] bits are ignored by the memory management hardware. You can write any value to these bits in the translation tables. In a system that implements access flag updates in hardware, a hardware access flag update never changes these bits.

B3.7.4 The effect of the Security Extensions on TEX remapping

When the Security Extensions are implemented, the MMU remap registers are banked in the Secure and Non-secure security states. The register versions for the current security state apply to all TLB lookups. The SCTLR.TRE bit is banked in the Secure and Non-secure copies of the register, and the appropriate version of this bit determines whether TEX remapping is applied to TLB lookups in the current security state.

When the Security Extensions are implemented, the translation table descriptors include an NS bit. For security reasons, the NS bit is not accessible through the MMU remap registers.

Write accesses to the Secure copies of the MMU remap registers are disabled when the **CP15SDISABLE** input is asserted HIGH, and the MCR operations to access these registers become UNDEFINED. For more information, see *The CP15SDISABLE input* on page B3-76.

B3.8 VMSA memory aborts

The mechanisms that cause the ARM processor to take an exception because of a failed memory access are:

MMU fault	The MMU detects an access restriction and signals the processor.
External abort	A memory system component other than the MMU signals an illegal or faulting memory access.

The exception taken is a Prefetch Abort exception if either of these occurs synchronously on an instruction fetch, and a Data Abort exception otherwise.

Collectively, these mechanisms are called *aborts*. The different abort mechanisms are described in:

- *MMU faults*
- *External aborts* on page B3-45.

An access that causes an abort is said to be aborted, and uses the *Fault Address Registers* (FARs) and *Fault Status Registers* (FSRs) to record context information. The FARs and FSRs are described in *Fault Status and Fault Address registers in a VMSA implementation* on page B3-48.

Also, a debug exception can cause the processor to take a Prefetch Abort exception or a Data Abort exception, and to update the FARs and FSRs. For details see Chapter C4 *Debug Exceptions* and *Debug event prioritization* on page C3-43.

B3.8.1 MMU faults

The MMU checks the memory accesses required for instruction fetches and for explicit memory accesses:

- if an instruction fetch faults it generates a Prefetch Abort exception
- if an explicit memory access faults it generates a Data Abort exception.

For more information about Prefetch Abort exceptions and Data Abort exceptions see *Exceptions* on page B1-30.

MMU faults are always synchronous. For more information, see *Terminology for describing exceptions* on page B1-4.

When the MMU generates an abort for a region of memory, no memory access is made if that region is or could be marked as Strongly-ordered or Device.

Fault-checking sequence

The sequence used by the MMU to check for access faults is slightly different for sections and pages. For both sections and pages:

- Figure B3-8 on page B3-41 shows the checking sequence
- Figure B3-9 on page B3-42 shows the descriptor fetch and check performed during the checking sequence.

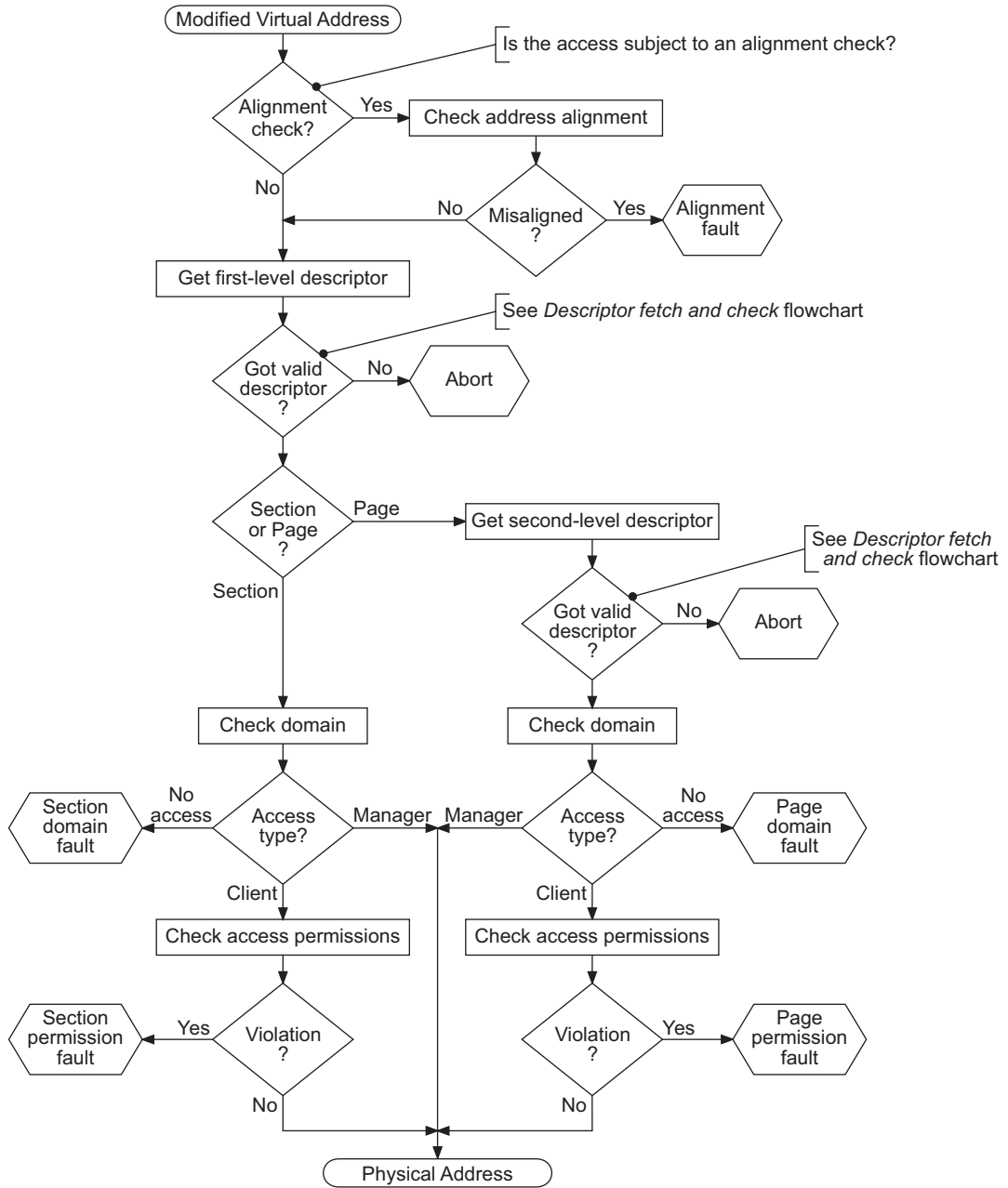

Figure B3-8 VMSA fault checking sequence

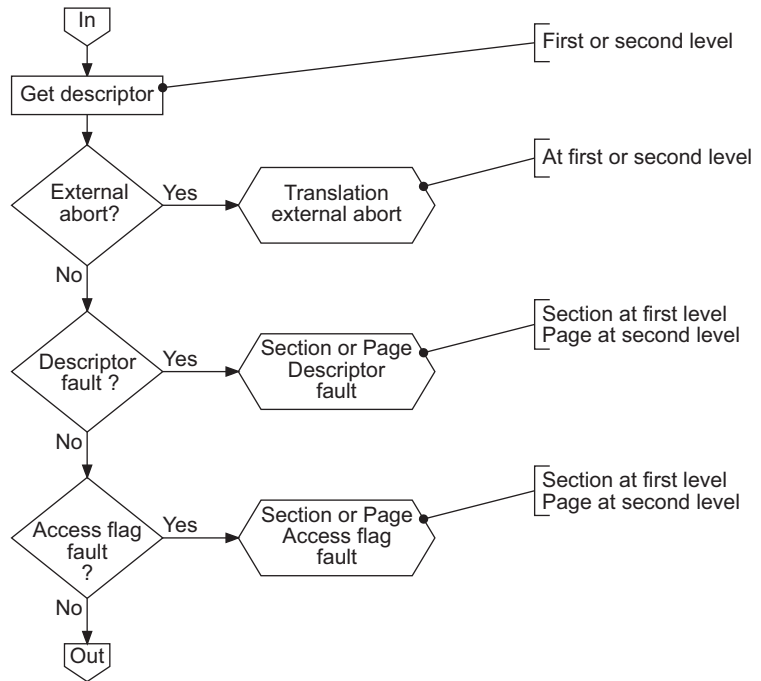

Figure B3-9 Descriptor fetch and check in the fault checking sequence

The faults that might be detected during the fault checking sequence are described in the following subsections:

- *Alignment fault*
- *External abort on a translation table walk*
- *Translation fault* on page B3-43
- *Access Flag fault* on page B3-43
- *Domain fault* on page B3-44
- *Permission fault* on page B3-44.

Alignment fault

The ARMv7 memory architecture requires support for strict alignment checking. This checking is controlled by the SCTLRA bit, see *c1, System Control Register (SCTLR)* on page B3-96. For details of when Alignment faults are generated see *Unaligned data access* on page A3-5.

External abort on a translation table walk

This is described in the section *External aborts* on page B3-45, see *External abort on a translation table walk* on page B3-46.

Translation fault

There are two types of Translation fault:

Section This is generated if the first-level descriptor is marked as invalid. This happens if bits [1:0] of the descriptor are:

- 0b00, the fault encoding
- 0b11, the reserved encoding.

For more information, see *First-level descriptors* on page B3-8.

Page This is generated if the second-level descriptor is marked as invalid. This happens if bits [1:0] of the descriptor are 0b00, the fault encoding. For more information, see *Second-level descriptors* on page B3-10.

Translation table entries that result in Translation faults are guaranteed not to be cached, meaning the TLB is not updated. Therefore, when a Translation fault occurs, it is not necessary to perform any TLB maintenance operations to remove the faulting entries.

Translation faults can be generated by data and unified cache maintenance operations by MVA. It is IMPLEMENTATION DEFINED whether Translation faults can be generated by instruction cache invalidate by MVA operations, see *Instruction cache maintenance operations by MVA* on page B3-25.

It is IMPLEMENTATION DEFINED whether Translation faults can be generated by branch predictor maintenance operations.

Access Flag fault

There are two types of Access Flag fault:

Section This can be generated when a section with AF == 0 is accessed.

Page This can be generated when a page with AF == 0 is accessed.

Access Flag faults only occur on a VMSAv7 implementation that provides software management of the access flag, and are only generated when the AFE flag is set to 1 in the SCTLR, see *c1, System Control Register (SCTLR)* on page B3-96.

Translation table entries that result in Access Flag faults are guaranteed not to be cached, meaning the TLB is not updated. Therefore, when an Access Flag fault occurs, it is not necessary to perform any TLB maintenance operations to remove the faulting entries.

It is IMPLEMENTATION DEFINED whether Access Flag faults can be generated by any cache maintenance operations by MVA.

It is IMPLEMENTATION DEFINED whether Access Flag faults can be generated by branch predictor invalidate by MVA operations.

For more information, see *The access flag* on page B3-21.

Domain fault

There are two types of Domain fault:

- Section** When a first-level descriptor fetch returns a valid Section first-level descriptor, the MMU checks the domain field of that descriptor against the Domain Access Control Register, and generates a Section Domain fault if this check fails.
- Page** When a second-level descriptor fetch returns a valid second-level descriptor, the MMU checks the domain field of the first-level descriptor that required the second-level fetch against the Domain Access Control Register, and generates a Page Domain fault if this check fails.

Domain faults cannot occur on cache or branch predictor maintenance operations.

For more information, see *Domains* on page B3-31.

Where a Domain fault results in an update to the associated translation tables, the appropriate TLB entry must be flushed to ensure correctness. For more information, see the translation table entry update example in *TLB maintenance operations and the memory order model* on page B3-59.

Changes to the Domain Access Control register must be synchronized by one of:

- performing a ISB operation
- an exception
- exception return.

For details see *Changes to CP15 registers and the memory order model* on page B3-77.

Permission fault

When a memory access is to a Client domain, the MMU checks the access permission field in the translation table entry. As with other MMU faults, there are two types of Permission fault:

- Section** This can be generated when a section in a Client domain is accessed.
- Page** This can be generated when a page in a Client domain is accessed.

For details of conditions that cause a Permission fault see *Access permissions* on page B3-28.

Where a Permission fault results in an update to the associated translation tables, the appropriate TLB entry must be flushed to ensure correctness. For more information, see the translation table entry update example in *TLB maintenance operations and the memory order model* on page B3-59.

Permission faults cannot occur on cache or branch predictor maintenance operations.

B3.8.2 External aborts

External aborts are defined as errors that occur in the memory system other than those that are detected by the MMU or Debug hardware. They include parity errors detected by the caches or other parts of the memory system. An external abort is one of:

- synchronous
- precise asynchronous
- imprecise asynchronous.

For more information, see *Terminology for describing exceptions* on page B1-4.

The ARM architecture does not provide a method to distinguish between precise asynchronous and imprecise asynchronous aborts.

The ARM architecture handles asynchronous aborts in a similar way to interrupts, except that they are reported to the processor using the Data Abort exception. Setting the CPSR.A bit to 1 masks asynchronous aborts, see *Program Status Registers (PSRs)* on page B1-14.

Normally, external aborts are rare. An imprecise asynchronous external abort is likely to be fatal to the process that is running. An example of an event that might cause an external abort is an uncorrectable parity or ECC failure on a Level 2 Memory structure.

It is IMPLEMENTATION DEFINED which external aborts, if any, are supported.

VMSAv7 permits external aborts on data accesses, translation table walks, and instruction fetches to be either synchronous or asynchronous. The DFSR indicates whether the external abort is synchronous or asynchronous, see *c5, Data Fault Status Register (DFSR)* on page B3-121.

Note

Because imprecise external aborts are normally fatal to the process that caused them, ARM recommends that implementations make external aborts precise wherever possible.

More information about possible external aborts is given in the subsections:

- *External abort on instruction fetch* on page B3-46
- *External abort on data read or write* on page B3-46
- *External abort on a translation table walk* on page B3-46
- *Behavior of external aborts on a translation table walk caused by a VA to PA translation* on page B3-46
- *Parity error reporting* on page B3-46.

For details of how external aborts are reported see *Fault Status and Fault Address registers in a VMSA implementation* on page B3-48.

External abort on instruction fetch

An external abort on an instruction fetch can be either synchronous or asynchronous. A synchronous external abort on an instruction fetch is taken precisely.

An implementation can report the external abort asynchronously from the instruction that it applies to. In such an implementation these aborts behave essentially as interrupts. They are masked by the CPSR.A bit when it is set to 1, otherwise they are reported using the Data Abort exception.

External abort on data read or write

Externally generated errors during a data read or write can be either synchronous or asynchronous.

An implementation can report the external abort asynchronously from the instruction that generated the access. In such an implementation these aborts behave essentially as interrupts. They are masked by the CPSR.A bit when it is set to 1, otherwise they are reported using the Data Abort exception.

External abort on a translation table walk

An external abort on a translation table walk can be either synchronous or asynchronous. If the external abort is synchronous then the result is:

- a synchronous Prefetch Abort exception if the translation table walk is for an instruction fetch
- a synchronous Data Abort exception if the translation table walk is for a data access.

An implementation can report the error in the translation table walk asynchronously from executing the instruction whose instruction fetch or memory access caused the translation table walk. In such an implementation these aborts behave essentially as interrupts. They are masked by the CPSR.A bit when it is set to 1, otherwise they are reported using the Data Abort exception.

Behavior of external aborts on a translation table walk caused by a VA to PA translation

The VA to PA translation operations described in *CP15 c7, Virtual Address to Physical Address translation operations* on page B3-130 require translation table walks. An external abort can occur in the translation table walk, as described in *External abort on a translation table walk*. The abort generates a Data Abort exception, and can be synchronous or asynchronous.

Parity error reporting

The ARM architecture supports the reporting of both synchronous and asynchronous parity errors from the cache systems. It is IMPLEMENTATION DEFINED what parity errors in the cache systems, if any, result in synchronous or asynchronous parity errors.

A fault status code is defined for reporting parity errors, see *Fault Status and Fault Address registers in a VMSA implementation* on page B3-48. However when parity error reporting is implemented it is IMPLEMENTATION DEFINED whether the assigned fault status code or another appropriate encoding is used to report parity errors.

For all purposes other than the fault status encoding, parity errors are treated as external aborts.

B3.8.3 Prioritization of aborts

For synchronous aborts, *Debug event prioritization* on page C3-43 describes the relationship between debug events, MMU faults and external aborts.

In general, the ARM architecture does not define when asynchronous events are taken, and therefore the prioritization of asynchronous events is IMPLEMENTATION DEFINED.

———— **Note** —————

A special requirement applies to asynchronous watchpoints, see *Debug event prioritization* on page C3-43.

B3.9 Fault Status and Fault Address registers in a VMSA implementation

This section describes the Fault Status and Fault Address registers, and how they report information about VMSA aborts. It contains the following subsections:

- *About the Fault Status and Fault Address registers*
- *Data Abort exceptions* on page B3-49
- *Prefetch Abort exceptions* on page B3-49
- *Fault Status Register encodings for the VMSA* on page B3-50
- *Distinguishing read and write accesses on Data Abort exceptions* on page B3-52
- *Provision for classification of external aborts* on page B3-52
- *The Domain field in the DFSR* on page B3-52
- *Auxiliary Fault Status Registers* on page B3-53.

Also, these registers are used to report information about debug exceptions. For details see *Effects of debug exceptions on CP15 registers and the DBGWFAAR* on page C4-4.

B3.9.1 About the Fault Status and Fault Address registers

VMSAv7 provides four registers for reporting fault address and status information:

- The *Data Fault Status Register*, see *c5, Data Fault Status Register (DFSR)* on page B3-121. The DFSR is updated on taking a Data Abort exception.
- The *Instruction Fault Status Register*, see *c5, Instruction Fault Status Register (IFSR)* on page B3-122. The IFSR is updated on taking a Prefetch Abort exception.
- The *Data Fault Address Register*, see *c6, Data Fault Address Register (DFAR)* on page B3-124. In some cases, on taking a synchronous Data Abort exception the DFAR is updated with the faulting address. See *Terminology for describing exceptions* on page B1-4 for a description of synchronous exceptions.
- The *Instruction Fault Address Register*, see *c6, Instruction Fault Address Register (IFAR)* on page B3-125. The IFAR is updated with the faulting address on taking a Prefetch Abort exception.

In addition, the architecture provides encodings for two IMPLEMENTATION DEFINED Auxiliary Fault Status Registers, see *Auxiliary Fault Status Registers* on page B3-53.

Note

- On a Data Abort exception that is generated by an instruction cache maintenance operation, the IFSR is also updated.
 - Before ARMv7, the *Data Fault Address Register (DFAR)* was called the *Fault Address Register (FAR)*.
-

On a Watchpoint debug exception, the *Watchpoint Fault Address Register* (DBGWFAR) is used to hold fault information. On a watchpoint access the DBGWFAR is updated with the address of the instruction that generated the Data Abort exception. For more information, see *Watchpoint Fault Address Register (DBGWFAR)* on page C10-28.

B3.9.2 Data Abort exceptions

On taking a Data Abort exception the processor:

- updates the DFSR with a fault status code
- if the Data Abort exception is synchronous:
 - updates the DFSR with whether the faulted access was a read or a write, and the domain number of the access, if applicable
 - if the Data Abort exception was not caused by a Watchpoint debug event, updates the DFAR with the MVA that caused the Data Abort exception
 - if the Data Abort exception was caused by a Watchpoint debug event, the DFAR becomes UNKNOWN
- if the Data Abort exception is asynchronous, the DFAR becomes UNKNOWN.

When the Security Extensions are implemented, the security state of the processor immediately after taking the Data Abort exception determines whether the Secure or Non-secure DFSR and DFAR are updated.

If the Data Abort exception is generated by an instruction cache or branch predictor invalidation by MVA, the DFSR indicates an Instruction Cache Maintenance Operation Fault and the IFSR indicates a Translation or Access Flag fault.

On an access that might have multiple aborts, the MMU fault checking sequence and the prioritization of aborts determine which abort occurs. For more information, see *Fault-checking sequence* on page B3-40 and *Prioritization of aborts* on page B3-47.

B3.9.3 Prefetch Abort exceptions

A Prefetch Abort exception is taken synchronously with the instruction that an abort is reported on. This means:

- If the instruction is executed a Prefetch Abort exception is generated.
- If the instruction fetch is issued but the processor does not attempt to execute the instruction no Prefetch Abort exception is generated for that instruction. For example, if the processor branches round the instruction no Prefetch Abort exception is generated.

On taking a Prefetch Abort exception the processor:

- updates the IFSR with a fault status code
- updates the IFAR with the MVA that caused the Prefetch Abort exception.

When the Security Extensions are implemented, the security state of the processor immediately after taking the Prefetch Abort exception determines whether the Secure or Non-secure DFSR and DFAR are updated.

B3.9.4 Fault Status Register encodings for the VMSA

For the fault status encodings for a VMSA implementation see:

- Table B3-11 for the Instruction Fault Status Register (IFSR) encodings
- Table B3-12 on page B3-51 for the Data Fault Status Register (DFSR) encodings.

———— **Note** —————

In previous ARM documentation, the terms precise and imprecise were used instead of synchronous and asynchronous. For details of the more exact terminology introduced in this manual see *Terminology for describing exceptions* on page B1-4.

Table B3-11 VMSAv7 IFSR encodings

IFSR [10,3:0] ^a	Source	IFAR	Notes
01100 01110	Translation table walk synchronous external abort	1st level 2nd level	Valid -
11100 11110	Translation table walk synchronous parity error	1st level 2nd level	Valid -
00101 00111	Translation fault	Section Page	Valid MMU fault
00011 ^b 00110	Access Flag fault	Section Page	Valid MMU fault
01001 01011	Domain fault	Section Page	Valid MMU fault
01101 01111	Permission fault	Section Page	Valid MMU fault
00010	Debug event		UNKNOWN See <i>Software debug events</i> on page C3-5
01000	Synchronous external abort		Valid -
10100	IMPLEMENTATION DEFINED		Valid Lockdown
11010	IMPLEMENTATION DEFINED		Valid Coprocessor abort
11001	Memory access synchronous parity error		Valid -

a. All IFSR[10,3:0] values not listed in this table are reserved.

b. Previously, this encoding was a deprecated encoding for Alignment fault. The extensive changes in the memory model in ARMv7 and VMSAv7 mean there should be no possibility of confusing these two uses.

Table B3-12 VMSAv7 DFSR encodings

DFSR [10,3:0] ^a	Source		DFAR	Domain	Notes
00001	Alignment fault		Valid	UNKNOWN	MMU fault
00100	Instruction cache maintenance fault		Valid	UNKNOWN	-
01100	Translation table walk	1st level	Valid	UNKNOWN	-
01110	synchronous external abort	2nd level	Valid	Valid	
11100	Translation table walk	1st level	Valid	UNKNOWN	-
11110	synchronous parity error	2nd level	Valid	Valid	
00101	Translation fault	Section	Valid	UNKNOWN	MMU fault
00111		Page	Valid	Valid	
00011 ^b	Access Flag fault	Section	Valid	UNKNOWN	MMU fault
00110		Page	Valid	Valid	
01001	Domain fault	Section	Valid	Valid	MMU fault
01011		Page	Valid	Valid	
01101	Permission fault	Section	Valid	Valid	MMU fault
01111		Page	Valid	Valid	
00010	Debug event		UNKNOWN	UNKNOWN	See <i>Software debug events</i> on page C3-5
01000	Synchronous external abort		Valid	UNKNOWN	-
10100	IMPLEMENTATION DEFINED		-	-	Lockdown
11010	IMPLEMENTATION DEFINED		-	-	Coprocessor abort
11001	Memory access synchronous parity error		Valid	UNKNOWN	-
10110	Asynchronous external abort ^c		UNKNOWN	UNKNOWN	-
11000	Memory access asynchronous parity error		UNKNOWN	UNKNOWN	Including on translation table walk

- All DFSR[10,3:0] values not listed in this table are reserved.
- Previously, this encoding was a deprecated encoding for Alignment fault. The extensive changes in the memory model in ARMv7 and VMSAv7 mean there should be no possibility of confusing these two uses.
- Including asynchronous data external abort on translation table walk or instruction fetch.

Reserved encodings in the IFSR and DFSR encodings tables

A single encoding is reserved for cache and TLB lockdown faults. The details of these faults and any associated subsidiary registers are IMPLEMENTATION DEFINED.

A single encoding is reserved for aborts associated with coprocessors. The details of these faults are IMPLEMENTATION DEFINED.

B3.9.5 Distinguishing read and write accesses on Data Abort exceptions

On a synchronous Data Abort exception, the DFSR.WnR bit, bit [11] of the register, indicates whether the abort occurred on a read access or on a write access. However, for a fault on a CP15 cache maintenance operation, including a fault on a VA to PA translation operation, this bit always indicates a write access fault.

For a fault generated by an SWP or SWPB instruction, the WnR bit is 0 if a read to the location would have generated a fault, otherwise it is 1.

B3.9.6 Provision for classification of external aborts

An implementation can use the DFSR.ExT and IFSR.ExT bits to provide more information about external aborts:

- DFSR.ExT can provide an IMPLEMENTATION DEFINED classification of external aborts on data accesses
- IFSR.ExT can provide an IMPLEMENTATION DEFINED classification of external aborts on instruction accesses

For all aborts other than external aborts these bits return a value of 0.

B3.9.7 The Domain field in the DFSR

The DFSR includes a domain field. This has been inherited from previous versions of the VMSA. There is no domain field in the IFSR. The domain field of the DFSR is not valid on watchpoints.

From ARMv7, use of the domain field in the DFSR is deprecated. This field might not be supported in future versions of the ARM architecture. ARM strongly recommends that new software does not use this field.

For both Data Abort exceptions and Prefetch Abort exceptions, software can find the domain information by performing a translation table read for the faulting address and extracting the domain field from the translation table entry.

B3.9.8 Auxiliary Fault Status Registers

ARMv7 architects two Auxiliary Fault Status Registers:

- the Auxiliary Data Fault Status Register (ADFSR)
- the Auxiliary Instruction Fault Status Register (AIFSR).

These registers enable additional fault status information to be returned:

- The position of these registers is architecturally-defined, but the content and use of the registers is IMPLEMENTATION DEFINED.
- An implementation that does not need to report additional fault information must implement these registers as UNK/SBZ. This ensures that a privileged attempt to access these registers does not cause an Undefined Instruction exception.

An example use of these registers would be to return more information for diagnosing parity errors.

See *c5, Auxiliary Data and Instruction Fault Status Registers (ADFSR and AIFSR)* on page B3-123 for the architectural details of these registers.

B3.10 Translation Lookaside Buffers (TLBs)

Translation Lookaside Buffers (TLBs) are an implementation technique that caches translations or translation table entries. TLBs avoid the requirement for every memory access to perform a translation table lookup. The ARM architecture does not specify the exact form of the TLB structures for any design. In a similar way to the requirements for caches, the architecture only defines certain principles for TLBs:

- The architecture has a concept of an entry locked down in the TLB. The method by which lockdown is achieved is IMPLEMENTATION DEFINED, and an implementation might not support lockdown.
- An unlocked entry in the TLB is not guaranteed to remain in the TLB.
- A locked entry in the TLB is guaranteed to remain in the TLB. However, a locked entry in a TLB might be updated by subsequent updates to the translation tables. Therefore it is not guaranteed to remain incoherent with an entry in the translation table if a change is made to the translation tables.
- A translation table entry that returns a Translation fault or an Access fault is guaranteed not to be held in the TLB. However a translation table entry that returns a Domain fault or a Permission fault might be held in the TLB.
- Any translation table entry that does not return a Translation or Access fault might be allocated to an enabled TLB at any time. The only translation table entries guaranteed not to be held in the TLB are those that return a Translation or Access fault.
- Software can rely on the fact that between disabling and re-enabling the MMU, entries in the TLB have not have been corrupted to give incorrect translations.

B3.10.1 Global and non-global regions in the virtual memory map

The VMSA permits the virtual memory map to be divided into global and non-global regions, distinguished by the nG bit in the translation table descriptors:

nG == 0 The translation is global.

nG == 1 The translation is process specific, meaning it relates to the current ASID, as defined by the CONTEXTIDR.

Each non-global region has an associated *Address Space Identifier* (ASID). These identifiers enable different translation table mappings to co-exist in a caching structure such as a TLB. This means that a new mapping of a non-global memory region can be created without removing previous mappings.

For a symmetric multiprocessor cluster where a single operating system is running on the set of processing elements, ARMv7 requires all ASID values to be assigned uniquely. In other words, each ASID value must have the same meaning to all processing elements in the system.

The use of non-global pages when FCSEIDR[31:25] is not 0b0000000 is UNPREDICTABLE.

B3.10.2 TLB matching

A TLB is a hardware caching structure for translation table information. Like other hardware caching structures, it is mostly invisible to software. However, there are some situations where it can become visible. These are associated with coherency problems caused by an update to the translation table that has not been reflected in the TLB. The TLB maintenance operations, described in *TLB maintenance* on page B3-56, enable software to prevent any TLB incoherency becoming a problem.

A particular case where the presence of the TLB can become visible is if the translation table entries that are in use under a particular ASID are changed without suitable invalidation of the TLB. This is an issue regardless of whether or not the translation table entries are global. In some cases, the TLB can hold two mappings for the same address, and this can lead to UNPREDICTABLE behavior

TLB block size

When the TLB is scanned, address matching is performed on bits [31: N] of the MVA, where N is \log_2 of the page size, or block size, for the TLB entry. In VMSAv7, a TLB can store entries based on the following block sizes:

Supersections consist of 16MB blocks of memory, $N = 24$

Sections consist of 1MB blocks of memory, $N = 20$

Large pages consist of 64KB blocks of memory, $N = 16$

Small pages consist of 4KB blocks of memory, $N = 12$.

Supersections, Sections and Large pages are supported to permit mapping of a large region of memory while using only a single entry in a TLB.

B3.10.3 TLB behavior at reset

In ARMv7, there is no requirement that a reset invalidates the TLBs. ARMv7 recognizes that an implementation might require caches, including TLBs, to maintain context over a system reset. Possible reasons for doing so include power management and debug requirements.

For ARMv7:

- All TLBs are disabled at reset.
- An implementation can require the use of a specific TLB *invalidation routine*, to invalidate the TLB arrays before they are enabled after a reset. The exact form of this routine is IMPLEMENTATION DEFINED, but if an invalidation routine is required it must be documented clearly as part of the documentation of the device.

ARM recommends that if an invalidation routine is required for this purpose, the routine is based on the ARMv7 TLB maintenance operations described in *CP15 c8, TLB maintenance operations* on page B3-138.

- When TLBs that have not been invalidated by some mechanism since reset are enabled, the state of those TLBs is UNPREDICTABLE.

Similar rules apply:

- to cache behavior, see *Behavior of the caches at reset* on page B2-6
- to branch predictor behavior, see *Behavior of the branch predictors at reset* on page B2-21.

B3.10.4 TLB lockdown

ARMv7 recognizes that any TLB lockdown scheme is heavily dependent on the microarchitecture, making it inappropriate to define a common mechanism across all implementations. This means that:

- ARMv7 does not require TLB lockdown support.
- If TLB lockdown support is implemented, the lockdown mechanism is IMPLEMENTATION DEFINED. However, key properties of the interaction of lockdown with the architecture must be documented as part of the implementation documentation.

This means that:

- In ARMv7, the TLB Type Register TLBTR does not define the lockdown scheme in use. This is a change from previous versions of the architecture.
- A region of the CP15 c10 encodings is reserved for IMPLEMENTATION DEFINED TLB functions, such as TLB lockdown functions. The reserved encodings are those with:
 - $\langle CRm \rangle = \{0, 1, 4, 8\}$
 - all values of $\langle opc2 \rangle$ and $\langle opc1 \rangle$.

See also *The implementation defined TLB control operations* on page B3-143.

An implementation might use some of the CP15 c10 encodings that are reserved for IMPLEMENTATION DEFINED TLB functions to implement additional TLB control functions. These functions might include:

- Unlock all locked TLB entries.
- Preload into a specific level of TLB. This is beyond the scope of the PLI and PLD hint instructions.

B3.10.5 TLB maintenance

TLB maintenance operations provide a mechanism to invalidate entries from a TLB_↓

Any TLB operation might affect other TLB entries that are not locked down.

TLB maintenance operations are provided by CP15 c8 functions. The following operations are supported:

- invalidate all unlocked entries in the TLB
- invalidate a single TLB entry, by MVA, or MVA and ASID for a non-global entry
- invalidate all TLB entries that match a specified ASID.

The Multiprocessing Extensions add the following operations:

- invalidate all TLB entries that match a specified ~~by~~ MVA, regardless of the ASID
- operations that apply across multiprocessors in the same Inner Shareable domain, see *Multiprocessor effects on TLB maintenance operations* on page B3-62.

In the TLB operations:

- An operation that depends on an MVA value includes a field for the ASID to be used as part of the translation. For a translation table entry that refers to a non-global region, the ASID must be specified.
- If the Security Extensions are implemented, operations include the current security state as part of the VA to PA address translation required for the TLB operation.

A single register function can apply one of these operations:

- when separate Instruction and Data TLBs are implemented, to:
 - only the Instruction TLB
 - only the Data TLB
 - both the Instruction TLB and the Data TLB
- the Unified TLB, when a Unified TLB is implemented.

The distinction between the Instruction TLB and Data TLB in TLB maintenance operations is historical and is not supported in newer instructions. The distinction is deprecated in ARMv7. Developers must not rely on this distinction being maintained in future versions of the ARM architecture.

The ARM architecture does not dictate the form in which the TLB stores translation table entries. However, for TLB invalidate operations, the size of the table entry that must be removed from the TLB must be at least the size that appears in the translation table entry.

These operations are described in *CP15 c8, TLB maintenance operations* on page B3-138.

The interaction of TLB maintenance operations with TLB lockdown

The precise interaction of TLB lockdown with the TLB maintenance operations is IMPLEMENTATION DEFINED. However, the architecturally-defined TLB maintenance operations must comply with these rules:

- The effect on locked entries of the TLB invalidate all unlocked entries and TLB invalidate by MVA all ASID operations is IMPLEMENTATION DEFINED. However, these operations must implement one of the following options:
 - Have no effect on entries that are locked down.
 - Generate an IMPLEMENTATION DEFINED Data Abort exception if an entry is locked down, or might be locked down. A fault status code is provided in the CP15 c5 fault status registers for cache and TLB lockdown faults, see Table B3-11 on page B3-50 and Table B3-12 on page B3-51.

This permits a typical usage model for TLB invalidate routines, where the routine invalidates a large range of addresses, without considering whether any entries are locked in the TLB.

- The effect on locked entries of the TLB invalidate by MVA and invalidate by ASID match operations is IMPLEMENTATION DEFINED. However, these operations must implement one of these options:
 - A locked entry is invalidated in the TLB.
 - The operation has no effect on a locked entry in the TLB. In the case of the Invalidate single entry by MVA, this means the operation is treated as a NOP.

- The operation generates an IMPLEMENTATION DEFINED Data Abort exception if it operates on an entry that is locked down, or might be locked down. A fault status code is provided in the CP15 c5 fault status registers for cache and TLB lockdown faults, see Table B3-11 on page B3-50 and Table B3-12 on page B3-51.

Any implementation that uses an abort mechanism for entries that might be locked must:

- document the IMPLEMENTATION DEFINED code sequences that then performs the required operations on entries that are not locked down
- implement one of the other specified alternatives for the locked entries.

ARM recommends that architecturally-defined operations are used wherever possible in such sequences, to minimize the number of customized operations required.

In addition, if an implementation uses an abort mechanisms for entries that might be locked it must also must provide a mechanism that ensures that no TLB entries are locked.

Similar rules apply to cache lockdown, see *The interaction of cache lockdown with cache maintenance* on page B2-18.

An unlocked entry in the TLB is not guaranteed to remain in the TLB. This means that, as a side effect of a TLB maintenance operation, any unlocked entry in the TLB might be invalidated.

The effect of the Security Extensions on the TLB maintenance operations

If an implementation includes the Security Extensions, the TLB maintenance operations must take account of the current security state. Table B3-13 summarizes how the Security Extensions affect these operations.

Table B3-13 TLB maintenance operations when the Security Extensions are implemented

TLB maintenance operation	TLB entries guaranteed to be invalidated
Invalidate all entries	All TLB entries accessible in the current security state.
Invalidate single entry by MVA	Targeted TLB entry, only if all of these apply: <ul style="list-style-type: none"> • the MVA value matches • the ASID value matches, for a non-global entry • the entry applies to the current security state.
Invalidate entries by ASID match	All non-global TLB entries for which both: <ul style="list-style-type: none"> • the ASID value matches • the entry applies to the current security state.
Invalidate entries by MVA, all ASID	All targeted TLB entries for which both: <ul style="list-style-type: none"> • the MVA value matches • the entry applies to the current security state.

The Security Extensions do not change the possible effects of TLB maintenance operations on entries that are locked or might be locked, as described in *The interaction of TLB maintenance operations with TLB lockdown* on page B3-57. If an implementation has TLB maintenance operations that generate aborts on entries that are locked or might be locked then those aborts can occur on any maintenance operation, regardless of the Security Extensions. However aborts must not be generated as a result of entries from the other security state.

TLB maintenance operations and the memory order model

The following rules describe the relations between the memory order model and the TLB maintenance operations:

- A TLB invalidate operation is complete when all memory accesses using the TLB entries that have been invalidated have been observed by all observers to the extent that those accesses are required to be observed, as determined by the shareability and cacheability of the memory locations accessed by the accesses. In addition, once the TLB invalidate operation is complete, no new memory accesses that can be observed by those observers using those TLB entries will be performed.
- A TLB maintenance operation is only guaranteed to be complete after the execution of a DSB instruction.
- An ISB instruction, or a return from an exception, causes the effect of all completed TLB maintenance operations that appear in program order before the ISB or return from exception to be visible to all subsequent instructions, including the instruction fetches for those instructions.
- An exception causes all completed TLB maintenance operations that appear in the instruction stream before the point where the exception was taken to be visible to all subsequent instructions, including the instruction fetches for those instructions.
- All TLB Maintenance operations are executed in program order relative to each other.
- The execution of a Data or Unified TLB maintenance operation is guaranteed not to affect any explicit memory access of any instruction that appears in program order before the TLB maintenance operation. This means no memory barrier instruction is required. This ordering is guaranteed by the hardware implementation.
- The execution of a Data or Unified TLB maintenance operation is only guaranteed to be visible to a subsequent explicit load or store operation after both:
 - the execution of a DSB instruction to ensure the completion of the TLB operation
 - a subsequent ISB instruction, or taking an exception, or returning from an exception.
- The execution of an Instruction or Unified TLB maintenance operation is only guaranteed to be visible to a subsequent instruction fetch after both:
 - the execution of a DSB instruction to ensure the completion of the TLB operation
 - a subsequent ISB instruction, or taking an exception, or returning from an exception.

The following rules apply when writing translation table entries. They ensure that the updated entries are visible to subsequent accesses and cache maintenance operations.

For TLB maintenance, the translation table walk is treated as a separate observer:

- A write to the translation tables, after it has been cleaned from the cache if appropriate, is only guaranteed to be seen by a translation table walk caused by an explicit load or store after the execution of both a DSB and an ISB.
However, it is guaranteed that any writes to the translation tables are not seen by any explicit memory access that occurs in program order before the write to the translation tables.
- For the base ARMv7 architecture and versions of the architecture before ARMv7, if the translation tables are held in Write-Back Cacheable memory, the caches must be cleaned to the point of unification after writing to the translation tables and before the DSB instruction. This ensures that the updated translation table are visible to a hardware translation table walk.
- A write to the translation tables, after it has been cleaned from the cache if appropriate, is only guaranteed to be seen by a translation table walk caused by the instruction fetch of an instruction that follows the write to the translation tables after both a DSB and an ISB.

Therefore, typical code for writing a translation table entry, covering changes to the instruction or data mappings in a uniprocessor system is:

```
STR rx, [Translation table entry]          ; write new entry to the translation table
Clean cache line [Translation table entry] : This operation is not required with the
                                           ; Multiprocessing Extensions.
DSB                                       ; ensures visibility of the data cleaned from the D Cache
Invalidate TLB entry by MVA (and ASID if non-global) [page address]
Invalidate BTC
DSB                                       ; ensure completion of the Invalidate TLB operation
ISB                                       ; ensure table changes visible to instruction fetch
```

Synchronization of changes of ASID and TTBR

A common virtual memory management requirement is to change the ContextID and Translation Table Base Registers together to associate the new ContextID with different translation tables. However, such a change is complicated by:

- the depth of prefetch being IMPLEMENTATION DEFINED
- the use of branch prediction.

The virtual memory management operations must ensure the synchronization of changes of the ContextID and the translation table registers. For example, some or all of the TLBs, BTCs (*Branch Target Caches*) and other caching of ASID and translation information might become corrupt with invalid translations.

Synchronization is necessary to avoid either:

- the *old* ASID being associated with translation table walks from the *new* translation tables
- the *new* ASID being associated with translation table walks from the *old* translation tables.

There are a number of possible solutions to this problem, and the most appropriate approach depends on the system. Example B3-2 on page B3-61 and Example B3-3 on page B3-61, and Example B3-4 on page B3-62 describe three possible approaches.

Note

Another instance of the synchronization problem occurs if a branch is encountered between changing the ASID and performing the synchronization. In this case the value in the branch predictor might be associated with the incorrect ASID. This possibility can be addressed by any of these approaches, but might be addressed by avoiding such branches.

Example B3-2 Using a reserved ASID to synchronize ASID and TTBR changes

In this approach, a particular ASID value is reserved for use by the operating system, and is used only for the synchronization of the ASID and Translation Table Base Register. This example uses the value of 0 for this purpose, but any value could be used.

This approach can be used only when the size of the mapping for any given virtual address is the same in the old and new translation tables.

The following sequence is followed, and must be executed from memory marked as being global:

```
Change ASID to 0
ISB
Change Translation Table Base Register
ISB
Change ASID to new value
```

This approach ensures that any non-global pages prefetched at a time when it is uncertain whether the old or new translation tables are being accessed are associated with the unused ASID value of 0. Since the ASID value of 0 is not used for any normal operations these entries cannot cause corruption of execution.

Example B3-3 Using translation tables that contain only global mappings when changing the ASID

A second approach involves switching the translation tables to a set of translation tables that only contain global mappings while switching the ASID.

The following sequence is followed, and must be executed from memory marked as being global:

```
Change Translation Table Base Register to the global-only mappings
ISB
Change ASID to new value
ISB
Change Translation Table Base Register to new value
```

This approach ensures that no non-global pages can be prefetched at a time when it is uncertain whether the old or new ASID value will be used.

Example B3-4 Disabling non-global mappings when changing the ASID

In systems where the only non-global mappings are held in TTBR0, you can use the TTBCR.PD0 field to disable use of the TTBR0 register during the change of ASID. This means you do not require a set of global-only mappings.

The following sequence is followed, and must be executed from a memory region with a translation that is accessed from the base address in the TTBR1 register, and is marked as global:

```
Set TTBCR.PD0 = 1
ISB
Change ASID to new value
Change Translation Table Base Register to new value
ISB
Set TTBCR.PD0 = 0
```

This approach ensures that no non-global pages can be prefetched at a time when it is uncertain whether the old or new ASID value will be used.

Multiprocessor effects on TLB maintenance operations

The base ARMv7 architecture defines that the TLB maintenance operations apply only to the TLB directly attached to the processor on which the operation is executed.

To improve the implementation of multiprocessor systems, a set of extensions to ARMv7, called the Multiprocessing Extensions, has been introduced. These introduce some new TLB maintenance operations to apply to the TLBs of processors in the same Inner Shareable domain.

The extensions can be implemented in a uniprocessor system with no hardware support for cache coherency. In such a system, the Inner Shareable domain would be limited to being the single processor, and all instructions defined to apply to the Inner Shareable domain behave as aliases of the local operations.

B3.11 Virtual Address to Physical Address translation operations

CP15 c7 includes operations for *Virtual Address (VA)* to *Physical Address (PA)* translation. For more information, see *CP15 c7, Virtual Address to Physical Address translation operations* on page B3-130. The details of these operations depend on whether the Security Extensions are implemented.

All VA to PA translations take account of the TEX remapping when this remapping is enabled, see *The alternative descriptions of the Memory region attributes* on page B3-32.

A VA to PA translation operation might require a translation table walk, and an external abort might occur on this walk. For more information, see *Behavior of external aborts on a translation table walk caused by a VA to PA translation* on page B3-46. If an external abort occurs on this walk:

- The Physical Address Register, PAR:
 - is not updated if the abort is synchronous
 - is UNPREDICTABLE if the abort is asynchronous.
- if the Security Extensions are implemented, fault status and fault address register updates occur only in the security state in which the abort is handled. Fault address and fault status registers in the other security state are not changed.

B3.12 CP15 registers for a VMSA implementation

This section gives a full description of the registers implemented in the CP15 System Control Coprocessor in an ARMv7 implementation that includes the VMSA memory system. Therefore, this is the description of the CP15 registers for an ARMv7-A implementation.

Some of the registers described in this section are also included in an ARMv7 implementation with a PMSA. The section *CP15 registers for a PMSA implementation* on page B4-22 also includes descriptions of these registers.

See *Coprocessors and system control* on page B1-62 for general information about the System Control Coprocessor, CP15 and the register access instructions MRC and MCR.

Information in this section is organized as follows:

- general information is given in:
 - *Organization of the CP15 registers in a VMSA implementation*
 - *General behavior of CP15 registers* on page B3-68
 - *Effect of the Security Extensions on the CP15 registers* on page B3-71
 - *Changes to CP15 registers and the memory order model* on page B3-77
 - *Meaning of fixed bit values in register diagrams* on page B3-78.
- this is followed by, for each of the primary CP15 registers c0 to c15:
 - a general description of the organization of the primary CP15 register
 - detailed descriptions of all the registers in that primary register.

————— Note —————

The detailed descriptions of the registers that implement the processor identification scheme, CPUID, are given in Chapter B5 *The CPUID Identification Scheme*, and not in this section.

Table B3-14 on page B3-66 lists all of the CP15 registers in a VMSA implementation, and is an index to the detailed description of each register.

B3.12.1 Organization of the CP15 registers in a VMSA implementation

Figure B3-10 on page B3-65 summarizes the ARMv7 CP15 registers when the VMSA is implemented. Table B3-14 on page B3-66 lists all of these registers.

————— Note —————

ARMv7 introduces significant changes to the memory system registers, especially in relation to caches. For details of:

- the CP15 register implementation in VMSAv6, see *Organization of CP15 registers for an ARMv6 VMSA implementation* on page AppxG-29
- how the ARMv7 registers must be used to discover what caches can be accessed by the processor, see *Identifying the cache resources in ARMv7* on page B2-4.

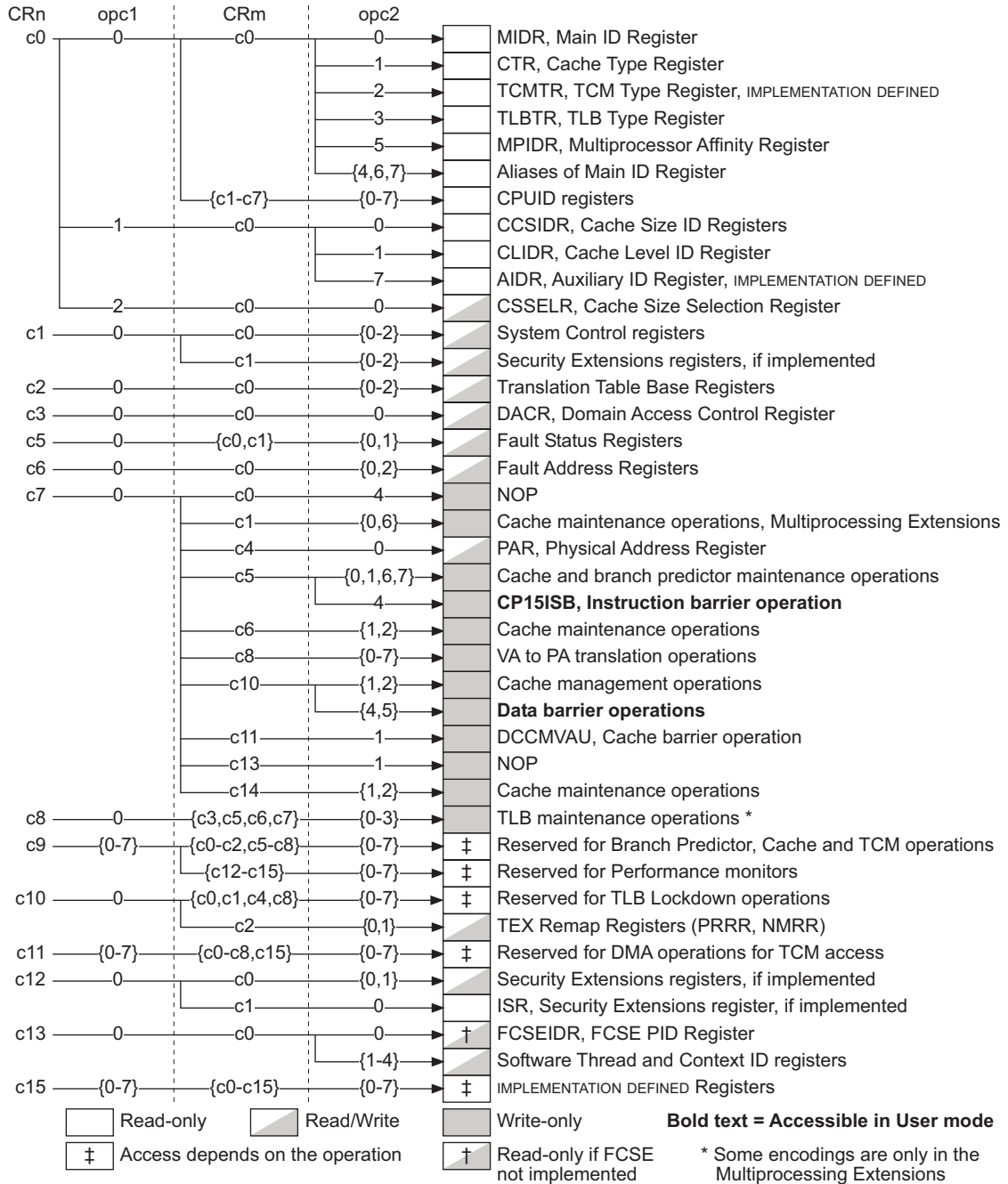

Figure B3-10 CP15 registers in a VMSA implementation

For information about the CP15 encodings not shown in Figure B3-10 on page B3-65 see *Unpredictable and undefined behavior for CP15 accesses* on page B3-68.

Summary of CP15 register descriptions in a VMSA implementation

Table B3-14 shows the CP15 registers in a VMSA implementation. The table also includes links to the descriptions of each of the primary CP15 registers, c0 to c15.

Table B3-14 Summary of VMSA CP15 register descriptions

Register and description
<i>CP15 c0, ID codes registers</i> on page B3-79
<i>c0, Main ID Register (MIDR)</i> on page B3-81
<i>c0, Cache Type Register (CTR)</i> on page B3-83
<i>c0, TCM Type Register (TCMTR)</i> on page B3-85
<i>c0, TLB Type Register (TLBTR)</i> on page B3-86
<i>c0, Multiprocessor Affinity Register (MPIDR)</i> on page B3-87
<i>CP15 c0, Processor Feature registers</i> on page B5-4
<i>c0, Debug Feature Register 0 (ID_DFR0)</i> on page B5-6
<i>c0, Auxiliary Feature Register 0 (ID_AFR0)</i> on page B5-8
<i>CP15 c0, Memory Model Feature registers</i> on page B5-9
<i>CP15 c0, Instruction Set Attribute registers</i> on page B5-19
<i>c0, Cache Size ID Registers (CCSIDR)</i> on page B3-91
<i>c0, Cache Level ID Register (CLIDR)</i> on page B3-92
<i>c0, Implementation defined Auxiliary ID Register (AIDR)</i> on page B3-94
<i>c0, Cache Size Selection Register (CSSELR)</i> on page B3-95
<i>CP15 c1, System control registers</i> on page B3-96
<i>c1, System Control Register (SCTLR)</i> on page B3-96
<i>c1, Implementation defined Auxiliary Control Register (ACTLR)</i> on page B3-103
<i>c1, Coprocessor Access Control Register (CPACR)</i> on page B3-104
<i>c1, Secure Configuration Register (SCR)</i> on page B3-106

Table B3-14 Summary of VMSA CP15 register descriptions (continued)

Register and description
<i>c1, Secure Debug Enable Register (SDER) on page B3-108</i>
<i>c1, Non-Secure Access Control Register (NSACR) on page B3-110</i>
<i>CP15 c2 and c3, Memory protection and control registers on page B3-113</i>
<i>c2, Translation Table Base Register 0 (TTBR0) on page B3-113</i>
<i>c2, Translation Table Base Register 1 (TTBR1) on page B3-116</i>
<i>c2, Translation Table Base Control Register (TTBCR) on page B3-117</i>
<i>c3, Domain Access Control Register (DACR) on page B3-119</i>
<i>CP15 c4, Not used on page B3-120</i>
<i>CP15 c5 and c6, Memory system fault registers on page B3-120</i>
<i>c5, Data Fault Status Register (DFSR) on page B3-121</i>
<i>c5, Instruction Fault Status Register (IFSR) on page B3-122</i>
<i>c5, Auxiliary Data and Instruction Fault Status Registers (ADFSR and AIFSR) on page B3-123</i>
<i>c6, Data Fault Address Register (DFAR) on page B3-124</i>
<i>c6, Instruction Fault Address Register (IFAR) on page B3-125</i>
<i>CP15 c7, Cache maintenance and other functions on page B3-126</i>
<i>CP15 c7, Cache and branch predictor maintenance functions on page B3-126</i>
<i>CP15 c7, Virtual Address to Physical Address translation operations on page B3-130</i>
<i>CP15 c7, Data and Instruction Barrier operations on page B3-137</i>
<i>CP15 c7, No Operation (NOP) on page B3-138</i>
<i>CP15 c8, TLB maintenance operations on page B3-138</i>
<i>CP15 c9, Cache and TCM lockdown registers and performance monitors on page B3-141</i>
<i>CP15 c10, Memory remapping and TLB control registers on page B3-142</i>
<i>c10, Primary Region Remap Register (PRRR) on page B3-143</i>
<i>c10, Normal Memory Remap Register (NMRR) on page B3-146</i>
<i>CP15 c11, Reserved for TCM DMA registers on page B3-147</i>

Table B3-14 Summary of VMSA CP15 register descriptions (continued)

Register and description
<i>CP15 c12, Security Extensions registers on page B3-148</i>
<i>c12, Vector Base Address Register (VBAR) on page B3-148</i>
<i>c12, Monitor Vector Base Address Register (MVBAR) on page B3-149</i>
<i>c12, Interrupt Status Register (ISR) on page B3-150</i>
<i>CP15 c13, Process, context and thread ID registers on page B3-151</i>
<i>c13, FCSE Process ID Register (FCSEIDR) on page B3-152</i>
<i>c13, Context ID Register (CONTEXTIDR) on page B3-153</i>
<i>CP15 c13 Software Thread ID registers on page B3-154</i>
<i>CP15 c14 is not used, see Unallocated CP15 encodings on page B3-69</i>
<i>CP15 c15, Implementation defined registers on page B3-155</i>

B3.12.2 General behavior of CP15 registers

The following sections give information about the general behavior of CP15 registers:

- *Read-only bits in read/write registers*
- *Unpredictable and undefined behavior for CP15 accesses*
- *Reset behavior of CP15 registers on page B3-70*

See also *Meaning of fixed bit values in register diagrams* on page B3-78.

Read-only bits in read/write registers

Some read/write registers include bits that are read-only. These bits ignore writes.

An example of this is the SCTL.R.NMFI bit, bit [27], see *c1, System Control Register (SCTLR)* on page B3-96.

UNPREDICTABLE and UNDEFINED behavior for CP15 accesses

In ARMv7 the following operations are UNDEFINED:

- all CDP, MCRR, MRRC, LDC and STC operations to CP15
- all CDP2, MCR2, MRC2, MCRR2, MRRC2, LDC2 and STC2 operations to CP15.

Unless otherwise indicated in the individual register descriptions:

- reserved fields in registers are UNK/SBZP
- reserved values of fields can have UNPREDICTABLE effects.

The following subsections give more information about UNPREDICTABLE and UNDEFINED behavior for CP15:

- *Unallocated CP15 encodings*
- *Rules for MCR and MRC accesses to CP15 registers*
- *Effects of the Security Extensions on page B3-70.*

Unallocated CP15 encodings

When MCR and MRC instructions perform CP15 operations, the CRn value for the instruction is the major register specifier for the CP15 space. Accesses to unallocated major registers are UNDEFINED. For the ARMv7-A Architecture, this means that:

- for an implementation that includes the Security Extensions, accesses with $\langle \text{CRn} \rangle = \{c4, c14\}$ are UNDEFINED
- for an implementation that does not include the Security Extensions, accesses with $\langle \text{CRn} \rangle = \{c4, c12, c14\}$ are UNDEFINED

In an allocated CP15 major register specifier, MCR and MRC accesses to all unallocated encodings are UNPREDICTABLE for privileged accesses. For the ARMv7-A architecture this means that:

- if the Security Extensions are implemented, any privileged MCR or MRC access with $\langle \text{CRn} \rangle \neq \{c4, c14\}$ and a combination of $\langle \text{opc1} \rangle$, $\langle \text{CRm} \rangle$ and $\langle \text{opc2} \rangle$ values not shown in Figure B3-10 on page B3-65 is UNPREDICTABLE.
- if the Security Extensions are not implemented, any privileged MCR or MRC access with $\langle \text{CRn} \rangle \neq \{c4, c12, c14\}$ and a combination of $\langle \text{opc1} \rangle$, $\langle \text{CRm} \rangle$ and $\langle \text{opc2} \rangle$ values not shown in Figure B3-10 on page B3-65 is UNPREDICTABLE.

Note

As shown in Figure B3-10 on page B3-65, accesses to unallocated principal ID registers map onto MIDR. These are accesses with $\langle \text{CRn} \rangle = c0$, $\langle \text{opc1} \rangle = 0$, $\langle \text{CRm} \rangle = c0$, and $\langle \text{opc2} \rangle = \{4, 6, 7\}$.

Rules for MCR and MRC accesses to CP15 registers

All MCR operations from the PC are UNPREDICTABLE for all coprocessors, including for CP15.

All MRC operations to APSR_nzcv are UNPREDICTABLE for CP15.

The following accesses are UNPREDICTABLE:

- an MCR access to an encoding for which no write behavior is defined in any circumstances
- an MRC access to an encoding for which no read behavior is defined in any circumstances.

Except for CP15 encoding that are accessible in User mode, all MCR and MRC accesses from User mode are UNDEFINED. This applies to all User mode accesses to unallocated CP15 encodings. Individual register descriptions, and the summaries of the CP15 major registers, show the CP15 encodings that are accessible in User mode.

Some individual registers can be made inaccessible by setting configuration bits, possibly including IMPLEMENTATION DEFINED configuration bits, to disable access to the register. The effects of the architecturally-defined configuration bits are defined individually in this manual. Typically, setting a configuration bit to disable access to a register results in the register becoming UNDEFINED for MRC and MCR accesses.

Effects of the Security Extensions

In Non-secure state, any User or privileged access to a CP15 register is UNDEFINED if either:

- There are no circumstances in which all bits and fields in the register can be accessed from Non-secure privileged modes.
- Settings in the NSACR mean that there are no circumstances in which all bits and fields in the register can be accessed from Non-secure privileged modes.

———— **Note** —————

The ARMv7-A architecture does not define any registers of this type. However an ARMv7-A implementation might include one or more IMPLEMENTATION DEFINED registers of this type.

When Non-secure access to a field of a CP15 register is controlled by an access control bit in the NSACR, and that access control bit is set to 0, then the controlled register field is RAZ/WI when accessed from a privileged mode in Non-secure state. If the register can be accessed from User mode then the field is also RAZ/WI when accessed from User mode.

If write access to a register is disabled by the **CP15SDISABLE** signal then any MCR access to that register is UNDEFINED.

Reset behavior of CP15 registers

After a reset, only a limited subset of the processor state is guaranteed to be set to defined values. On reset, the VMSAv7 architecture requires that the following CP15 registers are set to defined values.

———— **Note** —————

When the Security Extensions are implemented, only the Secure copy of a banked register is reset to the defined value.

- The SCTLR, see *c1, System Control Register (SCTLR)* on page B3-96.
- The CPACR, see *c1, Coprocessor Access Control Register (CPACR)* on page B3-104.
- The SCR, when the Security Extensions are implemented, see *c1, Secure Configuration Register (SCR)* on page B3-106.
- The TTBCR, see *c2, Translation Table Base Control Register (TTBCR)* on page B3-117.
- The Secure version of the VBAR, when the Security Extensions are implemented, see *c12, Vector Base Address Register (VBAR)* on page B3-148.

- The FCSEIDR, if the Fast Context Switch Extension (FCSE) is implemented, see *c13, FCSE Process ID Register (FCSEIDR)* on page B3-152. This register is RAZ/WI when the FCSE is not implemented.

For details of the reset values of these registers see the register descriptions. If the introductory description of a register does not include its reset value then the architecture does not require that register to be reset to a defined value.

The values of all other registers at reset are architecturally UNKNOWN. An implementation can assign an IMPLEMENTATION DEFINED reset value to a register whose reset value is architecturally UNKNOWN. After a reset, software must not rely on the value of any read/write register that does not have either an architecturally-defined reset value or an IMPLEMENTATION DEFINED reset value.

B3.12.3 Effect of the Security Extensions on the CP15 registers

When the Security Extensions are implemented, they integrate with many features of the architecture. Therefore, the descriptions of the individual CP15 registers include information about how the Security Extensions affect the register. This section:

- summarizes how the Security Extensions affect the implementation of the CP15 registers
- summarizes how the Security Extensions control access to the CP15 registers
- describes a Security Extensions signal that can control access to some CP15 registers.

It contains the following subsections:

- *Banked CP15 registers* on page B3-72
- *Restricted access CP15 registers* on page B3-73
- *Configurable access CP15 registers* on page B3-74
- *Common CP15 registers* on page B3-74
- *The CP15SDISABLE input* on page B3-76
- *Access to registers in Monitor mode* on page B3-77.

Note

- This section describes the effect of the Security Extensions on all of CP15 registers that are present in an implementation that includes the Security Extensions.
 - When the Security Extensions are implemented, the register classifications of Banked, Restricted access, Configurable, or Common can apply to some coprocessor registers in addition to the CP15 registers.
-

It is IMPLEMENTATION DEFINED whether each IMPLEMENTATION DEFINED register is Banked, Restricted access, Configurable, or Common.

Banked CP15 registers

When the Security Extensions are implemented, some CP15 registers are banked. Banked CP15 registers have two copies, one Secure and one Non-secure. The SCR.NS bit selects the Secure or Non-secure register, see *c1, Secure Configuration Register (SCR)* on page B3-106. Table B3-15 shows which registers are banked, and the permitted access to each register.

Table B3-15 Banked CP15 registers

CP15 register	Banked register	Permitted accesses ^a
c0	CSSELR, Cache Size Selection Register	Read/write in privileged modes only
c1	SCTLR, System Control Register ^b	Read/write in privileged modes only
	ACTLR, Auxiliary Control Register ^c	Read/write in privileged modes only
c2	TTBR0, Translation Table Base 0	Read/write in privileged modes only
	TTBR1, Translation Table Base 1	Read/write in privileged modes only
	TTBCR, Translation Table Base Control	Read/write in privileged modes only
c3	DACR, Domain Access Control Register	Read/write in privileged modes only
c5	DFSR, Data Fault Status Register	Read/write in privileged modes only
	IFSR, Instruction Fault Status Register	Read/write in privileged modes only
	ADFSR, Auxiliary Data Fault Status Register ^c	Read/write in privileged modes only
	AIFSR, Auxiliary Instruction Fault Status Register ^c	Read/write in privileged modes only
c6	DFAR, Data Fault Address Register	Read/write in privileged modes only
	IFAR, Instruction Fault Address Register	Read/write in privileged modes only
c7	PAR, Physical Address Register (VA to PA translation)	Read/write in privileged modes only
c10	PRRR, Primary Region Remap Register	Read/write in privileged modes only
	NMRR, Normal Memory Remap Register	Read/write in privileged modes only
c12	VBAR, Vector Base Address Register	Read/write in privileged modes only

Table B3-15 Banked CP15 registers (continued)

CP15 register	Banked register	Permitted accesses^a
c13	FCSEIDR, FCSE PID Register ^d	Read/write in privileged modes only
	CONTEXTIDR, Context ID Register	Read/write in privileged modes only
	TPIDRURW, User Read/Write Thread ID	Read/write in unprivileged and privileged modes
	TPIDRURO, User Read-only Thread ID	Read-only in User mode Read/write in privileged modes
	TPIDRPRW, Privileged Only Thread ID	Read/write in privileged modes only

- Any attempt to execute an access that is not permitted results in an Undefined Instruction exception.
- Some bits are common to the Secure and the Non-secure register, see *c1, System Control Register (SCTLR)* on page B3-96.
- Register is IMPLEMENTATION DEFINED.
- Banked only if the FCSE is implemented. The FCSE PID Register is RAZWI if the FCSE is not implemented.

A Banked CP15 register can contain a mixture of:

- fields that are banked
- fields that are read-only in Non-secure privileged modes but read/write in the Secure state.

The System Control Register SCTLR is an example of a register of that contains this mixture of fields.

The Secure copies of the Banked CP15 registers are sometimes referred to as the Secure Banked CP15 registers. The Non-secure copies of the Banked CP15 registers are sometimes referred to as the Non-secure Banked CP15 registers.

Restricted access CP15 registers

When the Security Extensions are implemented, some CP15 registers are present only in the Secure security state. These are called *Restricted access* registers, and their read/write access permissions are:

- Restricted access CP15 registers cannot be modified in Non-secure state.
- The NSACR can be read in Non-secure privileged modes, but not in Non-secure User mode. This enables software running in a Non-secure privileged mode to read the access permissions for CP15 registers that have configurable access.
- Apart from the NSACR, Restricted access CP15 registers cannot be read in Non-secure state.

Table B3-16 on page B3-74 shows the Restricted access CP15 registers when the Security Extensions are implemented:

Table B3-16 Restricted access CP15 registers

CP15 register	Secure register	Permitted accesses ^a
c1	NSACR, Non-Secure Access Control	Read/write in Secure privileged modes Read-only in Non-secure privileged modes
	SCR, Secure Configuration	Read/write in Secure privileged modes
	SDER, Secure Debug Enable	Read/write in Secure privileged modes
c12	MVBAR, Monitor Vector Base Address	Read/write in Secure privileged modes

a. Any attempt to execute an access that is not permitted results in an Undefined Instruction exception.

Configurable access CP15 registers

Access to some CP15 registers is configurable. These registers can be:

- accessible from Secure states only
- accessible from both Secure and Non-secure states.

Access is controlled by bits in the NSACR, see *c1, Non-Secure Access Control Register (NSACR)* on page B3-110.

In ARMv7-A, the only required Configurable access CP15 register is:

- CPACR, Coprocessor Access Control Register.

Common CP15 registers

Some CP15 registers and operations are common to the Secure and Non-secure security states. These are described as the *Common access* CP15 registers, or simply as the *Common* CP15 registers. These registers are:

- Read-only registers that hold configuration information.
- Register encodings used for various memory system operations, rather than to access registers.
- The Interrupt Status Register (ISR).

Table B3-17 shows the registers that are present in an ARMv7-A implementation that are not affected by the Security Extensions. When the Security Extensions are implemented these registers are sometimes described as the *common* registers.

Table B3-17 Common CP15 registers

CP15 register	Register	Permitted accesses ^a
c0	MIDR, Main ID Register	Read-only in privileged modes only
	CTR, Cache Type Register	Read-only in privileged modes only
	TCMTR, TCM Type Register ^b	Read-only in privileged modes only
	TLBTR, TLB Type Register ^b	Read-only in privileged modes only
	MPIDR, Multiprocessor Affinity Register	Read-only in privileged modes only
	ID_PFRx, Processor Feature Registers	Read-only in privileged modes only
	ID_DFR0, Debug Feature Register 0	Read-only in privileged modes only
	ID_AFR0, Auxiliary Feature Register 0	Read-only in privileged modes only
	ID_MMFRx, Memory Model Feature Registers	Read-only in privileged modes only
	ID_ISARx, Instruction Set Attribute Registers	Read-only in privileged modes only
	CCSIDR, Cache Size ID Register	Read-only in privileged modes only
	CLIDR, Cache Level ID Register	Read-only in privileged modes only
AIDR, Auxiliary ID Register ^b	Read-only in privileged modes only	
c7	NOP	Write-only in privileged modes only
	Cache maintenance operations	See <i>CP15 c7, Cache and branch predictor maintenance functions</i> on page B3-126
	VA to PA Translation operations	See <i>CP15 c7, Virtual Address to Physical Address translation operations</i> on page B3-130
	Data Barrier Operations	Write-only in unprivileged and privileged modes
c8	TLB maintenance operations	Write-only in privileged modes only
c9	Performance monitors	See <i>Access permissions</i> on page C9-12
c12	ISR, Interrupt Status Register	Read-only in privileged modes only

a. Any attempt to execute an access that is not permitted results in an Undefined Instruction exception.

b. Register or operation details are IMPLEMENTATION DEFINED.

Secure CP15 registers

The Secure CP15 registers comprise:

- The Secure copies of the Banked CP15 registers
- Restricted access CP15 registers
- Configurable access CP15 registers that are configured to be accessible only from Secure state.

The CP15SDISABLE input

The Security Extensions include an input signal, **CP15SDISABLE**, that disables write access to some of the Secure registers when asserted HIGH.

———— Note ————

The interaction between **CP15SDISABLE** and any IMPLEMENTATION DEFINED register is IMPLEMENTATION DEFINED.

Table B3-18 shows the registers and operations affected.

Table B3-18 Secure registers affected by CP15SDISABLE

CP15 register	Register name	Affected operation
c1	SCTLR, System Control Register	MCR p15, 0, <Rt>, c1, c0, 0
c2	TTBR0, Translation Table Base Register 0	MCR p15, 0, <Rt>, c2, c0, 0
	TTBCR, Translation Table Base Control Register	MCR p15, 0, <Rt>, c2, c0, 2
c3	DACR, Domain Access Control Register	MCR p15, 0, <Rt>, c3, c0, 0
c10	PRRR, Primary Region Remap Register	MCR p15, 0, <Rt>, c10, c2, 0
	NMRR, Normal Memory Remap Register	MCR p15, 0, <Rt>, c10, c2, 1
c12	VBAR, Vector Base Address Register	MCR p15, 0, <Rt>, c12, c0, 0
	MVBAR, Monitor Vector Base Address Register	MCR p15, 0, <Rt>, c12, c0, 1
c13	FCSEIDR, FCSE PID Register ^a	MCR p15, 0, <Rt>, c13, c0, 0

a. If the FCSE is implemented. The FCSE PID Register is RAZWI if the FCSE is not implemented.

On a reset by the external system, the **CP15SDISABLE** input signal must be taken LOW. This permits the Reset code to set up the configuration of the Security Extensions. When the input is asserted HIGH, any attempt to write to the Secure registers shown in Table B3-18 results in an Undefined Instruction exception.

The **CP15SDISABLE** input does not affect reading Secure registers, or reading or writing Non-secure registers. It is IMPLEMENTATION DEFINED how the input is changed and when changes to this input are reflected in the processor. However, changes must be reflected as quickly as possible. The change must occur before completion of a Instruction Synchronization Barrier operation, issued after the change, is visible to the processor with respect to instruction execution boundaries. Software must perform a Instruction Synchronization Barrier operation meeting the above conditions to ensure all subsequent instructions are affected by the change to **CP15SDISABLE**.

The assertion of **CP15SDISABLE** enables key Secure privileged features to be locked in a known good state, providing an additional level of overall system security. ARM expects control of this input to reside in the system, in a system block dedicated to security.

Access to registers in Monitor mode

When the processor is in Monitor mode, the processor is in Secure state regardless of the value of the SCR.NS bit. In Monitor mode, the SCR.NS bit determines whether the Secure Banked CP15 registers or Non-secure Banked CP15 registers are read or written using MRC or MCR instructions. That is:

- | | |
|---------------|---|
| NS = 0 | Common, Restricted access, and Secure Banked registers are accessed by CP15 MRC and MCR instructions.

CP15 operations use the security state to determine all resources used, that is, all CP15 based operations are performed in Secure state. |
| NS = 1 | Common, Restricted access and Non-secure Banked registers are accessed by CP15 MRC and MCR instructions.

CP15 operations use the security state to determine all resources used, that is, all CP15 based operations are performed in Secure state. |

The security state determines whether the Secure or Non-secure Banked registers are used to determine the control state.

B3.12.4 Changes to CP15 registers and the memory order model

All changes to CP15 registers that appear in program order after any explicit memory operations are guaranteed not to affect those memory operations.

Any change to CP15 registers is guaranteed to be visible to subsequent instructions only after one of:

- the execution of an ISB instruction
- the taking of an exception
- the return from an exception.

To guarantee the visibility of changes to some CP15 registers, additional operations might be required, on a case by case basis, before the ISB instruction, exception or return from exception. These cases are identified specifically in the definition of the registers.

However, for CP15 register accesses, all MRC and MCR instructions to the same register using the same register number appear to occur in program order relative to each other without context synchronization.

Where a change to the CP15 registers that is not yet guaranteed to be visible has an effect on exception processing, the following rule applies:

- When it is determined that an exception must be taken, any change of state held in CP15 registers involved in the triggering of the exception and that affects the processing of the exception is guaranteed to take effect before the exception is taken.

Therefore, in the following example, where initially A=1 and V=0, the LDR might or might not take a Data Abort exception due to the unaligned access, but if an exception occurs the vector used is affected by the V bit:

```
MCR p15, R0, c1, c0, 0 ; clears the A bit and sets the V bit
LDR R2, [R3]           ; unaligned load.
```

B3.12.5 Meaning of fixed bit values in register diagrams

In register diagrams, fixed bits are indicated by one of following:

- 0** In any implementation:
- the bit must read as 0
 - writes to the bit must be ignored.
- Software:
- can rely on the bit reading as 0
 - must use an SBZP policy to write to the bit.
- (0)** In any implementation:
- the bit must read as 0
 - writes to the bit must be ignored.
- Software:
- must not rely on the bit reading as 0
 - must use an SBZP policy to write to the bit.
- 1** In any implementation:
- the bit must read as 1
 - writes to the bit must be ignored.
- Software:
- can rely on the bit reading as 1
 - must use an SBOP policy to write to the bit.
- (1)** In any implementation:
- the bit must read as 1
 - writes to the bit must be ignored.
- Software:
- must not rely on the bit reading as 1
 - must use an SBOP policy to write to the bit.

Fields that are more than 1 bit wide are sometimes described as UNK/SBZP, instead of having each bit marked as (0).

B3.12.6 CP15 c0, ID codes registers

The CP15 c0 registers are used for processor and feature identification. Figure B3-11 shows the CP15 c0 registers.

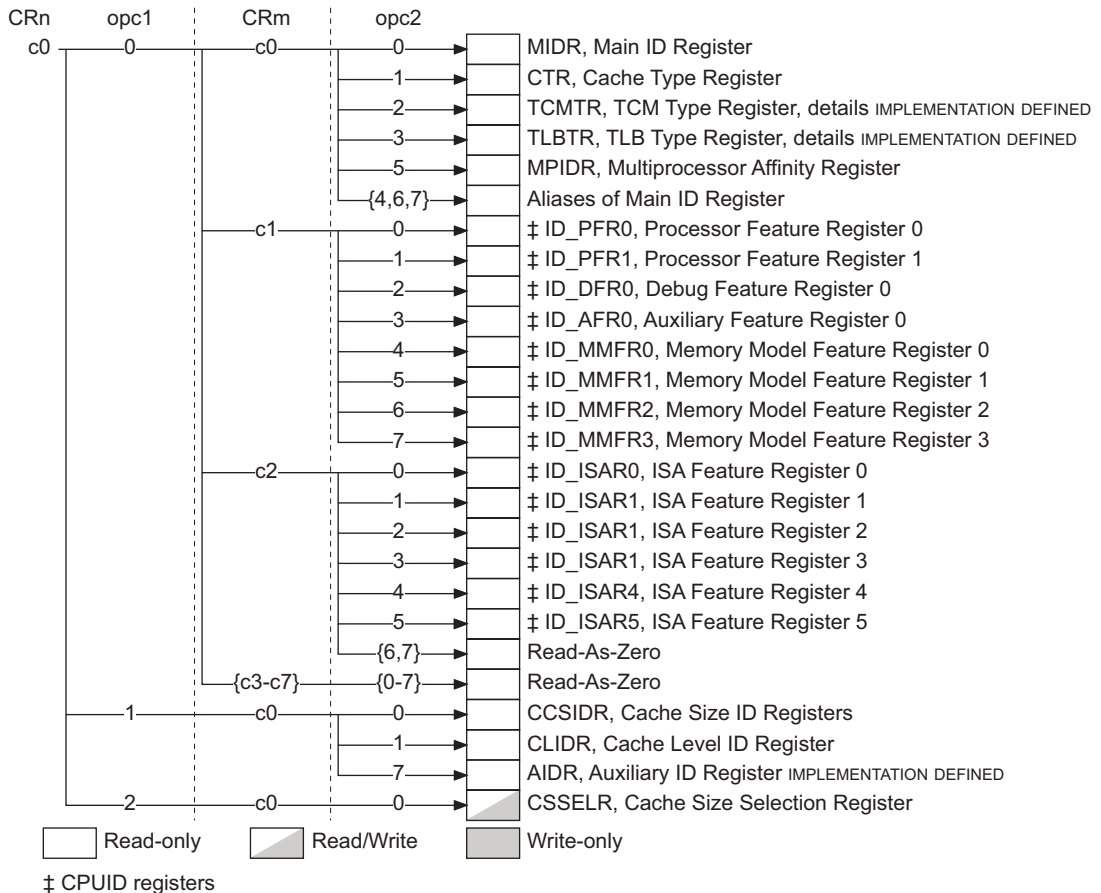

Figure B3-11 CP15 c0 registers in a VMSA implementation

CP15 c0 register encodings not shown in Figure B3-11 are UNPREDICTABLE, see *Unallocated CP15 encodings* on page B3-69.

Note

Chapter B5 *The CPUID Identification Scheme* describes the CPUID registers shown in Figure B3-11.

Table B3-19 lists the CP15 c0 registers and shows where each register is described in full. The table does not include the reserved and aliased registers that are shown in Figure B3-11 on page B3-79.

Table B3-19 Index to CP15 c0 register descriptions

opc1	CRm	opc2	Register and description
0	c0	0	<i>c0, Main ID Register (MIDR)</i> on page B3-81
		1	<i>c0, Cache Type Register (CTR)</i> on page B3-83
		2	<i>c0, TCM Type Register (TCMTR)</i> on page B3-85
		3	<i>c0, TLB Type Register (TLBTR)</i> on page B3-86
		5	<i>c0, Multiprocessor Affinity Register (MPIDR)</i> on page B3-87
		4, 6, 7	<i>c0, Main ID Register (MIDR)</i> on page B3-81
		c1	0, 1
	2		<i>c0, Debug Feature Register 0 (ID_DFR0)</i> on page B5-6
	3		<i>c0, Auxiliary Feature Register 0 (ID_AFR0)</i> on page B5-8
	4-7		<i>CP15 c0, Memory Model Feature registers</i> on page B5-9
c2	0-5	<i>CP15 c0, Instruction Set Attribute registers</i> on page B5-19	
1	c0	0	<i>c0, Cache Size ID Registers (CCSIDR)</i> on page B3-91
		1	<i>c0, Cache Level ID Register (CLIDR)</i> on page B3-92
		7	<i>c0, Implementation defined Auxiliary ID Register (AIDR)</i> on page B3-94
2	c0	0	<i>c0, Cache Size Selection Register (CSSELR)</i> on page B3-95

Note

The CPUID scheme described in Chapter B5 *The CPUID Identification Scheme* includes information about the implementation of the optional VFP and Advanced SIMD architecture extensions. See *Advanced SIMD and VFP extensions* on page A2-20 for a summary of the implementation options for these features.

B3.12.7 c0, Main ID Register (MIDR)

The Main ID Register, MIDR, provides identification information for the processor, including an implementer code for the device and a device ID number.

The MIDR is:

- a 32-bit read-only register
- accessible only in privileged modes
- when the Security Extensions are implemented, a Common register.

Some fields of the MIDR are IMPLEMENTATION DEFINED. For details of the values of these fields for a particular ARMv7 implementation, and any implementation-specific significance of these values, see the product documentation.

The format of the MIDR is:

31	24 23	20 19	16 15	4 3	0
Implementer	Variant	Architecture	Primary part number	Revision	

Implementer, bits [31:24]

The Implementer code. Table B3-20 shows the permitted values for this field:

Table B3-20 Implementer codes

Bits [31:24]	ASCII character	Implementer
0x41	A	ARM Limited
0x44	D	Digital Equipment Corporation
0x4D	M	Motorola, Freescale Semiconductor Inc.
0x51	Q	QUALCOMM Inc.
0x56	V	Marvell Semiconductor Inc.
0x69	i	Intel Corporation

All other values are reserved by ARM and must not be used.

Variant, bits [23:20]

An IMPLEMENTATION DEFINED variant number. Typically, this field is used to distinguish between different product variants, or major revisions of a product.

Architecture, bits [19:16]

Table B3-21 shows the permitted values for this field:

Table B3-21 Architecture codes

Bits [19:16]	Architecture
0x1	ARMv4
0x2	ARMv4T
0x3	ARMv5 (obsolete)
0x4	ARMv5T
0x5	ARMv5TE
0x6	ARMv5TEJ
0x7	ARMv6
0xF	Defined by CPUID scheme

All other values are reserved by ARM and must not be used.

Primary part number, bits [15:4]

An IMPLEMENTATION DEFINED primary part number for the device.

Note

On processors implemented by ARM, if the top four bits of the primary part number are 0x0 or 0x7, the variant and architecture are encoded differently, see *c0, Main ID Register (MIDR)* on page AppxH-34. Processors implemented by ARM have an Implementer code of 0x41.

Revision, bits [3:0]

An IMPLEMENTATION DEFINED revision number for the device.

ARMv7 requires all implementations to use the CPUID scheme, described in Chapter B5 *The CPUID Identification Scheme*, and an implementation is described by the MIDR with the CPUID registers.

Note

For an ARMv7 implementation by ARM, the MIDR is interpreted as:

- Bits [31:24]** Implementer code, must be 0x41.
- Bits [23:20]** Major revision number, rX.
- Bits [19:16]** Architecture code, must be 0xF.
- Bits [15:4]** ARM part number.
- Bits [3:0]** Minor revision number, pY.

Accessing the MIDR

To access the MIDR you read the CP15 registers with <opc1> set to 0, <CRn> set to c0, <CRm> set to c0, and <opc2> set to 0. For example:

```
MRC p15,0,<Rt>,c0,c0,0 ; Read CP15 Main ID Register
```

B3.12.8 c0, Cache Type Register (CTR)

The Cache Type Register, CTR, provides information about the architecture of the caches.

The CTR is:

- a 32-bit read-only register
- accessible only in privileged modes
- when the Security Extensions are implemented, a Common register.

The format of the CTR is changed in ARMv7. The new format of the register is indicated by Bit [31:29] being set to 0b100. For details of the format of the Cache Type Register in versions of the ARM architecture before ARMv7 see *c0, Cache Type Register (CTR)* on page AppxH-35.

In ARMv7, the format of the CTR is:

31	29	28	27	24	23	20	19	16	15	14	13	4	3	0
1	0	0	0	CWG	ERG	DminLine	L1Ip	0	0	0	0	0	0	IminLine

Bits [31:29] Set to 0b100 for the ARMv7 register format. Set to 0b000 for the format used in ARMv6 and earlier.

Bit [28] RAZ.

CWG, bits [27:24]

Cache Writeback Granule. \log_2 of the number of words of the maximum size of memory that can be overwritten as a result of the eviction of a cache entry that has had a memory location in it modified.

A value of 0b0000 indicates that the CTR does not provide Cache Writeback Granule information and either:

- the architectural maximum of 512 words (2Kbytes) must be assumed
- the Cache Writeback Granule can be determined from maximum cache line size encoded in the Cache Size ID Registers.

Values greater than 0b1001 are reserved.

ERG, bits [27:24]

Exclusives Reservation Granule. \log_2 of the number of words of the maximum size of the reservation granule that has been implemented for the Load-Exclusive and Store-Exclusive instructions. For more information, see *Tagging and the size of the tagged memory block* on page A3-20.

A value of 0b0000 indicates that the CTR does not provide Exclusives Reservation Granule information and the architectural maximum of 512 words (2Kbytes) must be assumed.

Values greater than 0b1001 are reserved.

DminLine, bits [19:16]

\log_2 of the number of words in the smallest cache line of all the data caches and unified caches that are controlled by the processor.

L1Ip, bits [15:14]

Level 1 instruction cache policy. Indicates the indexing and tagging policy for the L1 instruction cache. Table B3-22 shows the possible values for this field.

Table B3-22 Level 1 instruction cache policy field values

L1Ip bits	L1 instruction cache indexing and tagging policy
00	Reserved
01	<i>ASID-tagged Virtual Index, Virtual Tag (AIVIVT)</i>
10	<i>Virtual Index, Physical Tag (VIPT)</i>
11	<i>Physical Index, Physical Tag (PIPT)</i>

Bits [13:4] RAZ.

IminLine, bits [3:0]

\log_2 of the number of words in the smallest cache line of all the instruction caches that are controlled by the processor.

Accessing the CTR

To access the CTR you read the CP15 registers with <opc1> set to 0, <CRn> set to c0, <CRm> set to c0, and <opc2> set to 1. For example

```
MRC p15,0,<Rt>,c0,c0,1 ; Read CP15 Cache Type Register
```

B3.12.9 c0, TCM Type Register (TCMTR)

The TCM Type Register, TCMTR, provides information about the implementation of the TCM.

The TCMTR is:

- a 32-bit read-only register
- accessible only in privileged modes.
- when the Security Extensions are implemented, a Common register.

From ARMv7:

- TCMTR must be implemented
- when the ARMv7 format is used, the meaning of register bits [28:0] is IMPLEMENTATION DEFINED
- the ARMv6 format of the TCM Type Register remains a valid usage model
- if no TCMs are implemented the ARMv6 format must be used to indicate zero-sized TCMs.

The ARMv7 format of the TCMTR is:

31	29	28	0
1	0	0	IMPLEMENTATION DEFINED

Bits [31:29] Set to 0b100 for the ARMv7 register format.

———— **Note** —————

This field is set to 0b000 for the format used in ARMv6 and earlier.

Bits [28:0] IMPLEMENTATION DEFINED in the ARMv7 register format.

If no TCMs are implemented, the TCMTR must be implemented with this ARMv6 format:

31	29	28	19	18	16	15	3	2	0	
0	0	0	UNKNOWN	0	0	0	UNKNOWN	0	0	0

For details of the ARMv6 optional implementation of the TCM Type Register see *c0, TCM Type Register (TCMTR)* on page AppxG-33.

Accessing the TCMTR

To access the TCMTR you read the CP15 registers with <opc1> set to 0, <CRn> set to c0, <CRm> set to c0, and <opc2> set to 2. For example:

MRC p15,0,<Rt>,c0,c0,2 ; Read CP15 TCM Type Register

B3.12.10 c0, TLB Type Register (TLBTR)

The TLB Type Register, TLBTR, provides information about the TLB implementation. The register must define whether the implementation provides separate instruction and data TLBs, or a unified TLB. Normally, the IMPLEMENTATION DEFINED information in this register includes the number of lockable entries in the TLB.

The TLBTR is:

- a 32-bit read-only register
- accessible only in privileged modes
- implemented only when the VMSA is implemented
- when the Security Extensions are implemented, a Common register.

The format of the TLBTR is:



Bits [31:1] IMPLEMENTATION DEFINED.

nU, bit [0] Not Unified TLB. Indicates whether the implementation has a unified TLB:

nU == 0 Unified TLB.

nU == 1 Separate Instruction and Data TLBs.

———— Note ————

From ARMv7, the TLB lockdown mechanism is IMPLEMENTATION DEFINED, and therefore the details of bits [31:1] of the TLB Type Register are IMPLEMENTATION DEFINED.

Accessing the TLBTR

To access the TLBTR you read the CP15 registers with <opc1> set to 0, <CRn> set to c0, <CRm> set to c0, and <opc2> set to 3. For example:

MRC p15,0,<Rt>,c0,c0,3 ; Read CP15 TLB Type Register

B3.12.11 c0, Multiprocessor Affinity Register (MPIDR)

The Multiprocessor Affinity Register, MPIDR, provides an additional processor identification mechanism for scheduling purposes in a multiprocessor system. In a uniprocessor system ARM recommends that this register returns a value of 0.

The MPIDR is:

- a 32-bit read-only register
- accessible only in privileged modes
- when the Security Extensions are implemented, a Common register
- introduced in ARMv7.

In the ARMv7 base architecture the format of the MPIDR is:

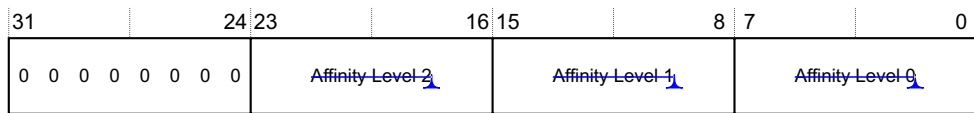

When the Multiprocessing Extensions are implemented the format of the MPIDR is:

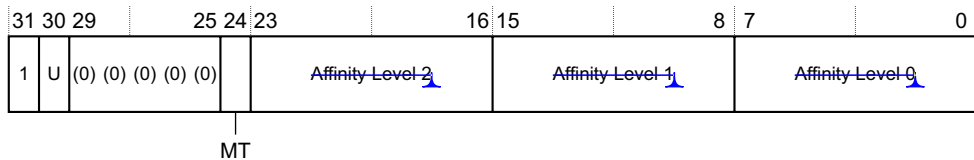

Note

In the MIDR bit definitions, a *processor in the system* can be a physical processor or a virtual CPU.

Bits [31:24], ARMv7 base architecture

Reserved, RAZ.

Bits [31], Multiprocessing Extensions

RAO. Indicates that the processor implements the Multiprocessing Extensions register format.

U bit, bit [30], Multiprocessing Extensions

Indicates a Uniprocessor system, as distinct from processor 0 in a multiprocessor system. The possible values of this bit are:

- 0** Processor is part of a multiprocessor system.
- 1** Processor is part of a uniprocessor system

Bits [29:25], Multiprocessing Extensions

Reserved, UNK.

MT bit, bit [24], Multiprocessing Extensions

Indicates whether the lowest level of affinity consists of logical processors that are implemented using a multi-threading type approach. The possible values of this bit are:

- 0** Performance of processors at the lowest affinity level is largely independent.
- 1** Performance of processors at the lowest affinity level is very interdependent

For more information about the meaning of this bit see *Multi-threading approach to lowest affinity levels, Multiprocessing Extensions* on page B3-89.

~~Affinity level 2~~, bits [23:16]

~~The least significant affinity level field, for this processor in the system.~~

~~Affinity level 1~~, bits [15:8]

~~The intermediate affinity level field, for this processor in the system.~~

~~Affinity level 0~~, bits [7:0]

~~The most significant level field, for this processor in the system.~~

In the system as a whole, for each of the affinity level fields, the assigned values must start at 0 and increase monotonically.

~~Increasing monotonically means that:~~

- ~~• There must not be any gaps in the sequence of numbers used.~~
- ~~• A higher value of the field includes any properties indicated by all lower values of the field.~~

When matching against an affinity level field, scheduler software checks for a value equal to or greater than a required value.

Recommended use of the MPIDR on page B3-89 includes a description of an example multiprocessor system and the affinity level field values it might use.

The interpretation of these fields is IMPLEMENTATION DEFINED, and must be documented as part of the documentation of the multiprocessor system. ARM recommends that this register might be used as described in the next subsection.

The software mechanism to discover the total number of affinity numbers used at each level is IMPLEMENTATION DEFINED, and is part of the general system identification task.



Multi-threading approach to lowest affinity levels, Multiprocessing Extensions

When the Multiprocessing Extensions are implemented, if the MPIDR.MT bit is set to 1, this indicates that the processors at affinity level 0 are logical processors, implemented using a multi-threading type approach. In such an approach, there can be a significant performance impact if a new thread is assigned the processor with:

- the same Affinity Level 0 value as some other thread, referred to as the original thread
- a pair of values for Affinity Levels 2 and 3 that are different to the pair of values of the original thread.

In this situation, the performance of the original thread might be significantly reduced.

Note

In this description, thread always refers to a thread or a process.

Recommended use of the MPIDR

In a multiprocessor system the register might provide two important functions:

- Identifying special functionality of a particular processor in the system. In general, the actual meaning of the affinity level fields is not important. In a small number of situations, an affinity level field value might have a special IMPLEMENTATION DEFINED significance. Possible examples include booting from reset and power-down events.
- Providing affinity information for the scheduling software, to help the scheduler run an individual thread or process on either:
 - the same processor, or as similar a processor as possible, as the processor it was running on previously
 - a processor on which a related thread or process was run.

Note

~~A monotonically increasing single number ID mechanism provides a convenient index into software arrays and for accessing the interrupt controller. This might be:~~

- ~~performed as part of the boot sequence~~
 - ~~stored as part of the local storage of threads.~~
-

MPIDR provides a mechanism with up to three levels of affinity information, but the meaning of those levels of affinity is entirely IMPLEMENTATION DEFINED. The levels of affinity provided can have different meanings. Table B3-23 on page B3-90 shows two possible implementations:

Table B3-23 Possible implementations of the affinity levels

Affinity Level	Example system 1	Example system 2
0	Virtual CPUs in a multi-threaded processor	Processors in an SMP cluster
1	Processors in an <i>Symmetric Multi Processor</i> (SMP) cluster	Clusters with a system
2	Clusters in a system	No meaning, fixed as 0.

The scheduler maintains affinity level information for all threads and processes. When it has to reschedule a thread or process the scheduler:

- looks for an available processor that matches at all three affinity levels
- if this fails, it might look for a processor that matches at levels 2 and 3 only
- if it still cannot find an available processor it might look for a match at level 3 only.

A multiprocessor system corresponding to Example system 1 in Table B3-23 might implement affinity values as shown in Table B3-24:

Table B3-24 Example of possible affinity values at different affinity levels

Affinity level 2 Cluster level	Affinity level 1 Processor level	Affinity level 0 Virtual CPU level
0	0	0, 1
0	1	0, 1
0	2	0, 1
0	3	0, 1
1	0	0, 1
1	1	0, 1
1	2	0, 1
1	3	0, 1

Accessing the MPIDR

To access MPIDR you read the CP15 registers with <opc1> set to 0, <CRn> set to c0, <CRm> set to c0, and <opc2> set to 5. For example:

```
MRC p15,0,<Rt>,c0,c0,5 ; Read Multiprocessor Affinity Register
```

B3.12.12 c0, Cache Size ID Registers (CCSIDR)

The Cache Size ID Registers, CCSIDR, provide information about the architecture of the caches.

The CCSIDR registers are:

- 32-bit read-only registers
- accessible only in privileged modes
- when the Security Extensions are implemented, Common registers
- introduced in ARMv7.

One CCSIDR is implemented for each cache that can be accessed by the processor. CSSELR selects which Cache Size ID Register is accessible, see *c0, Cache Size Selection Register (CSSELR)* on page B3-95.

The format of a CCSIDR is:

31	30	29	28	27	13	12	3	2	0
W T	W B	R A	W A	NumSets	Associativity			LineSize	

WT, bit [31] Indicates whether the cache level supports Write-Through, see Table B3-25.

WB, bit [30] Indicates whether the cache level supports Write-Back, see Table B3-25.

RA, bit [29] Indicates whether the cache level supports Read-Allocation, see Table B3-25.

WA, bit [28] Indicates whether the cache level supports Write-Allocation, see Table B3-25.

Table B3-25 WT, WB, RA and WA bit values

WT, WB, RA or WA bit value	Meaning
0	Feature not supported
1	Feature supported

NumSets, bits [27:13]

(Number of sets in cache) - 1, therefore a value of 0 indicates 1 set in the cache. The number of sets does not have to be a power of 2.

Associativity, bits [12:3]

(Associativity of cache) - 1, therefore a value of 0 indicates an associativity of 1. The associativity does not have to be a power of 2.

LineSize, bits [2:0]

($\text{Log}_2(\text{Number of words in cache line})$) - 2. For example:

- For a line length of 4 words: $\text{Log}_2(4) = 2$, LineSize entry = 0.

This is the minimum line length.

- For a line length of 8 words: $\text{Log}_2(8) = 3$, LineSize entry = 1.

Accessing the currently selected CCSIDR

The CSSELR selects a CCSIDR, see *c0, Cache Size Selection Register (CSSELR)* on page B3-95. To access the currently-selected CCSIDR you read the CP15 registers with <opc1> set to 1, <CRn> set to c0, <CRm> set to c0, and <opc2> set to 0. For example:

```
MRC p15,1,<Rt>,c0,c0,0 ; Read current CP15 Cache Size ID Register
```

Accessing the CCSIDR when the value in CSSELR corresponds to a cache that is not implemented returns an UNKNOWN value.

B3.12.13 c0, Cache Level ID Register (CLIDR)

The Cache Level ID Register, CLIDR:

- identifies the type of cache, or caches, implemented at each level, up to a maximum of eight levels
- identifies the Level of Coherency and Level of Unification for the cache hierarchy.

The CLIDR is:

- a 32-bit read-only register
- accessible only in privileged modes
- when the Security Extensions are implemented, a Common register
- introduced in ARMv7.

The format of the CLIDR is:

31	30	29	27	26	24	23	21	20	18	17	15	14	12	11	9	8	6	5	3	2	0
0	0	LoUU	LoC	LoUIS	Ctype7	Ctype6	Ctype5	Ctype4	Ctype3	Ctype2	Ctype1										

Bits [31:30] RAZ.

LoUU, bits [29:27]

Level of Unification Uniprocessor for the cache hierarchy, see *Clean, Invalidate, and Clean and Invalidate* on page B2-11.

LoC, bits [26:24]

Level of Coherency for the cache hierarchy, see *Clean, Invalidate, and Clean and Invalidate* on page B2-11.

LoUIS, bits [23:21]

Level of Unification Inner Shareable for the cache hierarchy, see *Clean, Invalidate, and Clean and Invalidate* on page B2-11. This field is RAZ in implementations that do not implement the Multiprocessing Extensions.

CtypeX, bits $[3(x - 1) + 2:3(x - 1)]$, for $x = 1$ to 7

Cache Type fields. Indicate the type of cache implemented at each level, from Level 1 up to a maximum of seven levels of cache hierarchy. The Level 1 cache field, Ctype1, is bits [2:0], see register diagram. Table B3-26 shows the possible values for each CtypeX field.

Table B3-26 Ctype bit values

CtypeX value	Meaning, cache implemented at this level
000	No cache
001	Instruction cache only
010	Data cache only
011	Separate instruction and data caches
100	Unified cache
101, 11X	Reserved

If you read the Cache Type fields from Ctype1 upwards, once you have seen a value of 0b000, no caches exist at further out levels of the hierarchy. So, for example, if Ctype3 is the first Cache Type field with a value of 0b000, the values of Ctype4 to Ctype7 must be ignored.

The CLIDR describes only the caches that are under the control of the processor.

Accessing the CLIDR

To access the CLIDR you read the CP15 registers with <opc1> set to 1, <CRn> set to c0, <CRm> set to c0, and <opc2> set to 1. For example:

```
MRC p15,1,<Rt>,c0,c0,1 ; Read CP15 Cache Level ID Register
```

B3.12.14 c0, IMPLEMENTATION DEFINED Auxiliary ID Register (AIDR)

The IMPLEMENTATION DEFINED Auxiliary ID Register, AIDR, provides implementation-specific ID information. The value of this register must be used in conjunction with the value of MIDR.

The IMPLEMENTATION DEFINED AIDR is:

- a 32-bit read-only register
- accessible only in privileged modes
- when the Security Extensions are implemented, a Common register
- introduced in ARMv7.

The format of the AIDR is IMPLEMENTATION DEFINED.

Accessing the AIDR

To access the AIDR you read the CP15 registers with <opc1> set to 1, <CRn> set to c0, <CRm> set to c0, and <opc2> set to 7. For example:

MRC p15,1,<Rt>,c0,c0,7 ; Read IMPLEMENTATION DEFINED Auxiliary ID Register

B3.12.15 c0, Cache Size Selection Register (CSSELR)

The Cache Size Selection Register, CSSELR, selects the current CCSIDR. An ARMv7 implementation must include a CCSIDR for every implemented cache that is under the control of the processor. The CSSELR identifies which CP1CSID register can be accessed, by specifying, for the required cache:

- the cache level
- the cache type, either:
 - instruction cache.
 - Data cache. The data cache argument is also used for a unified cache.

The CSSELR is:

- a 32-bit read/write register
- accessible only in privileged modes
- when the Security Extensions are implemented, a Banked register
- introduced in ARMv7.

The format of the CSSELR is:

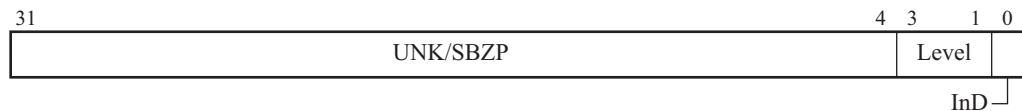

Bits [31:4] UNK/SBZP.

Level, bits [3:1]

Cache level of required cache. Permitted values are from 0b000, indicating Level 1 cache, to 0b110 indicating Level 7 cache.

InD, bit [0]

Instruction not Data bit. Permitted values are:

- 0** Data or unified cache
- 1** Instruction cache.

If CSSELR is set to indicate a cache that is not implemented, the result of reading CCSIDR is UNPREDICTABLE.

Accessing CSSELR

To access CSSELR you read or write the CP15 registers with <opc1> set to 2, <CRn> set to c0, <CRm> set to c0, and <opc2> set to 0. For example:

```
MRC p15,2,<Rt>,c0,c0,0 ; Read Cache Size Selection Register
MCR p15,2,<Rt>,c0,c0,0 ; Write Cache Size Selection Register
```

B3.12.16 CP15 c1, System control registers

The CP15 c1 registers are used for system control. Figure B3-12 shows the CP15 c1 registers.

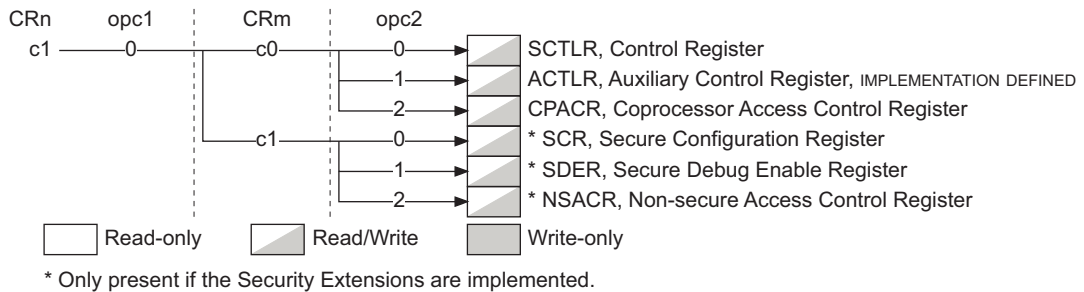

Figure B3-12 CP15 c1 registers in a VMSA implementation

CP15 c1 register encodings not shown in Figure B3-12 are UNPREDICTABLE. When the Security Extensions are not implemented all encodings with CRm == c1 are UNPREDICTABLE. For more information, see *Unallocated CP15 encodings* on page B3-69.

The following sections describe the CP15 c1 registers:

- *c1, System Control Register (SCTLR)*
- *c1, Implementation defined Auxiliary Control Register (ACTLR)* on page B3-103
- *c1, Coprocessor Access Control Register (CPACR)* on page B3-104
- *c1, Secure Configuration Register (SCR)* on page B3-106
- *c1, Secure Debug Enable Register (SDER)* on page B3-108
- *c1, Non-Secure Access Control Register (NSACR)* on page B3-110.

B3.12.17 c1, System Control Register (SCTLR)

The System Control Register, SCTLR, provides the top level control of the system, including its memory system.

The SCTLR:

- Is a 32-bit read/write register, with different access rights for some bits of the register.
In ARMv7, some bits in the register are read-only. These bits relate to non-configurable features of an ARMv7 implementation, and are provided for compatibility with previous versions of the architecture.
- Is accessible only in privileged modes.
- Has a defined reset value. The reset value is IMPLEMENTATION DEFINED, see *Reset value of the SCTLR* on page B3-102. When the Security Extensions are implemented the defined reset value applies only to the Secure copy of the SCTLR, and software must program the non-banked read/write bits of the Non-secure copy of the register with the required values.

- When the Security Extensions are implemented:
 - is a Banked register, with some bits common to the Secure and Non-secure copies of the register
 - has write access to the Secure copy of the register disabled when the **CP15SDISABLE** signal is asserted HIGH.

For more information, see *Effect of the Security Extensions on the CP15 registers* on page B3-71.

Control bits in the SCTLR that are not applicable to a VMSA implementation read as the value that most closely reflects that implementation, and ignore writes.

In an ARMv7-A implementation the format of the SCTLR is:

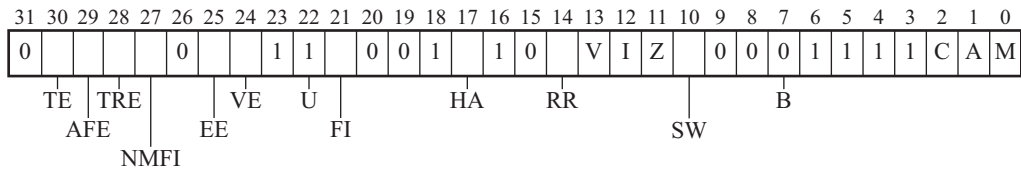

Bit [31] UNK/SBZP.

TE, bit [30] Thumb Exception enable. This bit controls whether exceptions are taken in ARM or Thumb state:

0 Exceptions, including reset, handled in ARM state

1 Exceptions, including reset, handled in Thumb state.

When the Security Extensions are implemented, this bit is banked between the Secure and Non-secure versions of the register.

An implementation can include a configuration input signal that determines the reset value of the TE bit. If there is no configuration input signal to determine the reset value of this bit then it resets to 0 in an ARMv7-A implementation.

For more information about the use of this bit see *Instruction set state on exception entry* on page B1-35.

AFE, bit [29] Access Flag Enable bit. This bit enables use of the AP[0] bit in the translation table descriptors as an *access flag*. It also restricts access permissions in the translation table descriptors to the simplified model described in *Simplified access permissions model* on page B3-29. The possible values of this bit are:

0 In the translation table descriptors, AP[0] is an access permissions bit. The full range of access permissions is supported. No access flag is implemented.

1 In the translation table descriptors, AP[0] is an access flag. Only the simplified model for access permissions is supported.

When the Security Extensions are implemented, this bit is banked between the Secure and Non-secure versions of the register.

TRE, bit [28] TEX Remap Enable bit. This bit enables remapping of the TEX[2:1] bits for use as two translation table bits that can be managed by the operating system. Enabling this remapping also changes the scheme used to describe the memory region attributes in the VMSA. The possible values of this bit are:

- 0** TEX Remap disabled. TEX[2:0] are used, with the C and B bits, to describe the memory region attributes.
- 1** TEX Remap enabled. TEX[2:1] are reassigned for use as flags managed by the operating system. The TEX[0], C and B bits are used to describe the memory region attributes, with the MMU remap registers.

When the Security Extensions are implemented, this bit is banked between the Secure and Non-secure versions of the register.

For more information, see *The alternative descriptions of the Memory region attributes* on page B3-32.

NMFI, bit [27]

Non-maskable ~~Fast Interrupts enable:~~

- 0** ~~Fast interrupts (FIQs) can be masked in the CPSR~~
- 1** ~~Fast interrupts are non-maskable~~



When the Security Extensions are implemented this bit is common to the Secure and Non-secure versions of the register.

This bit is read-only. It is IMPLEMENTATION DEFINED whether an implementation supports *Non-Maskable Fast Interrupts* (NMFI):

- If NMFI are not supported then this bit must be RAZ.
- If NMFI are supported then this bit is controlled by a configuration input signal.

For more information, see *Non-maskable fast interrupts* on page B1-18.

Bit [26] RAZ/SBZP.

EE, bit [25] Exception Endianness bit. The value of this bit defines the value of the CPSR.E bit on entry to an exception vector, including reset. This value also indicates the endianness of the translation table data for translation table lookups. The permitted values of this bit are:

- 0** Little endian
- 1** Big endian.

When the Security Extensions are implemented, this bit is banked between the Secure and Non-secure versions of the register.

This is a read/write bit. An implementation can include a configuration input signal that determines the reset value of the EE bit. If there is no configuration input signal to determine the reset value of this bit then it resets to 0.

VE, bit [24] Interrupt Vectors Enable bit. This bit controls the vectors used for the FIQ and IRQ interrupts. The permitted values of this bit are:

- 0** Use the FIQ and IRQ vectors from the vector table, see the V bit entry
- 1** Use the IMPLEMENTATION DEFINED values for the FIQ and IRQ vectors.

When the Security Extensions are implemented, this bit is banked between the Secure and Non-secure versions of the register.

For more information, see *Vectored interrupt support* on page B1-32.

If the implementation does not support IMPLEMENTATION DEFINED FIQ and IRQ vectors then this bit is RAZ/WI.

Bit [23] RAO/SBOP.

U, bit [22] In ARMv7 this bit is RAO/SBOP, indicating use of the alignment model described in *Alignment support* on page A3-4.

For details of this bit in earlier versions of the architecture see *Alignment* on page AppxG-6.

FI, bit [21] Fast Interrupts configuration enable bit. This bit can be used to reduce interrupt latency in an implementation by disabling IMPLEMENTATION DEFINED performance features. The permitted values of this bit are:

0 All performance features enabled.

1 Low interrupt latency configuration. Some performance features disabled.

When the Security Extensions are implemented, this bit is common to the Secure and Non-secure versions of the register.

This bit is:

- a read/write bit if the Security Extensions are not implemented
- if the Security Extensions are implemented:
 - a read/write bit if the processor is in Secure state
 - a read-only bit if the processor is in Non-secure state.

For more information, see *Low interrupt latency configuration* on page B1-43.

If the implementation does not support a mechanism for selecting a low interrupt latency configuration this bit is RAZ/WI.

Bit [20:19] RAZ/SBZP.

Bit [18] RAO/SBOP.

HA, bit [17] Hardware Access Flag Enable bit. If the implementation provides hardware management of the access flag this bit enables the access flag management:

0 Hardware management of access flag disabled

1 Hardware management of access flag enabled.

If the Security Extensions are implemented then this bit is banked between the Secure and Non-secure versions of the register.

If the implementation does not provide hardware management of the access flag then this bit is RAZ/WI.

For more information, see *Hardware management of the access flag* on page B3-21.

Bit [16] RAO/SBOP.

Bit [15] RAZ/SBZP.

RR, bit [14] Round Robin bit. If the cache implementation supports the use of an alternative replacement strategy that has a more easily predictable worst-case performance, this bit selects it:

- 0** Normal replacement strategy, for example, random replacement
- 1** Predictable strategy, for example, round-robin replacement.

When the Security Extensions are implemented, this bit is common to the Secure and Non-secure versions of the register.

This bit is:

- a read/write bit if the Security Extensions are not implemented
- if the Security Extensions are implemented:
 - a read/write bit if the processor is in Secure state
 - a read-only bit if the processor is in Non-secure state.

The replacement strategy associated with each value of the RR bit is IMPLEMENTATION DEFINED.

If the implementation does not support multiple IMPLEMENTATION DEFINED replacement strategies this bit is RAZ/WI.

V, bit [13] Vectors bit. This bit selects the base address of the exception vectors:

- 0** Normal exception vectors, base address 0x00000000.
When the Security Extensions are implemented this base address can be re-mapped.
- 1** High exception vectors (Hivecs), base address 0xFFFF0000.
This base address is never remapped.

When the Security Extensions are implemented, this bit is banked between the Secure and Non-secure versions of the register.

An implementation can include a configuration input signal that determines the reset value of the V bit. If there is no configuration input signal to determine the reset value of this bit then it resets to 0.

For more information, see *Exception vectors and the exception base address* on page B1-30.

I, bit [12] Instruction cache enable bit: This is a global enable bit for instruction caches:

- 0** Instruction caches disabled
- 1** Instruction caches enabled.

When the Security Extensions are implemented, this bit is banked between the Secure and Non-secure versions of the register.

If the system does not implement any instruction caches that can be accessed by the processor, at any level of the memory hierarchy, this bit is RAZ/WI.

If the system implements any instruction caches that can be accessed by the processor then it must be possible to disable them by setting this bit to 0.

Cache enabling and disabling on page B2-8 describes the effect of enabling the caches.

- Z, bit [11]** Branch prediction enable bit. This bit is used to enable branch prediction, also called program flow prediction:
- 0** Program flow prediction disabled
 - 1** Program flow prediction enabled.
- When the Security Extensions are implemented, this bit is banked between the Secure and Non-secure versions of the register.
- If program flow prediction cannot be disabled, this bit is RAO/WI. Program flow prediction includes all possible forms of speculative change of instruction stream prediction. Examples include static prediction, dynamic prediction, and return stacks.
- If the implementation does not support program flow prediction this bit is RAZ/WI.
- SW, bit[10]** SWP/SWPB Enable bit. This bit enables the use of SWP and SWPB instructions:
- 0** SWP and SWPB are UNDEFINED
 - 1** SWP and SWPB perform as described in *SWP, SWPB* on page A8-432.
- When the Security Extensions are implemented, this bit is banked between the Secure and Non-secure versions of the register. The bit is reset to 0.
- This is part of the Multiprocessing Extensions. In implementations that do not implement the Multiprocessing Extensions this bit is RAZ and SWP and SWPB instructions perform as described in *SWP, SWPB* on page A8-432.
- **Note** —————
- At reset, this bit disables SWP and SWPB. This means that operating systems have to choose to use SWP or SWPB.
-
- Bits [9:8]** RAZ/SBZP.
- B, bit [7]** In ARMv7 this bit is RAZ/SBZP, indicating use of the endianness model described in *Endian support* on page A3-7.
- For details of this bit in earlier versions of the architecture see *Endian support* on page AppxG-7 and *Endian support* on page AppxH-7.
- Bits [6:3]** RAO/SBOP.
- C, bit [2]** Cache enable bit: This is a global enable bit for data and unified caches:
- 0** Data and unified caches disabled
 - 1** Data and unified caches enabled.
- When the Security Extensions are implemented, this bit is banked between the Secure and Non-secure versions of the register.
- If the system does not implement any data or unified caches that can be accessed by the processor, at any level of the memory hierarchy, this bit is RAZ/WI.
- If the system implements any data or unified caches that can be accessed by the processor then it must be possible to disable them by setting this bit to 0.
- Cache enabling and disabling* on page B2-8 describes the effect of enabling the caches.

A, bit [1] Alignment bit. This is the enable bit for Alignment fault checking:

0 Alignment fault checking disabled

1 Alignment fault checking enabled.

When the Security Extensions are implemented, this bit is banked between the Secure and Non-secure versions of the register.

For more information, see *Alignment fault* on page B3-42, for a VMSA implementation.

M, bit [0] MMU enable bit. This is a global enable bit for the MMU:

0 MMU disabled

1 MMU enabled.

When the Security Extensions are implemented, this bit is banked between the Secure and Non-secure versions of the register.

For more information, see *Enabling and disabling the MMU* on page B3-5.

Reset value of the SCTLR

The SCTLR has a defined reset value that is IMPLEMENTATION DEFINED. There are different types of bit in the SCTLR:

- Some bits are defined as RAZ or RAO, and have the same value in all VMSAv7 implementations. Figure B3-13 on page B3-103 shows the values of these bits.
- Some bits are read-only and either:
 - have an IMPLEMENTATION DEFINED value
 - have a value that is determined by a configuration input signal.
- Some bits are read/write and either:
 - reset to zero
 - reset to an IMPLEMENTATION DEFINED value
 - reset to a value that is determined by a configuration input signal.

Figure B3-13 on page B3-103 shows the reset value, or how the reset value is defined, for each bit of the SCTLR. It also shows the possible values of each half byte of the register.

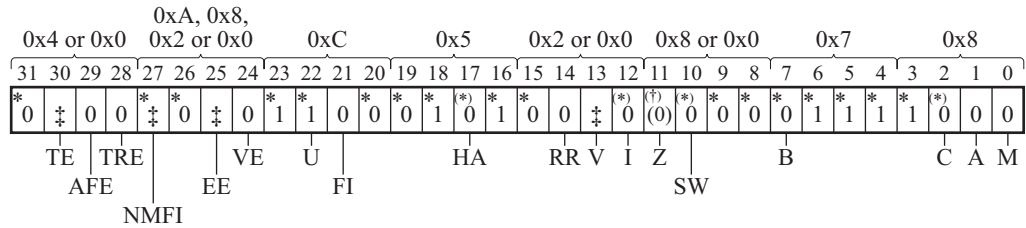

* Read-only bits, including RAZ and RAO bits.

(*) Can be RAZ. Otherwise read/write, resets to 0.

(†) Can be read-only, with IMPLEMENTATION DEFINED value. Otherwise resets to 0.

‡ Value or reset value can depend on configuration input. Otherwise RAZ or resets to 0.

Figure B3-13 Reset value of the SCTLR, ARMv7-A (VMSAv7)

Accessing the SCTL

To access the SCTL you read or write the CP15 registers with <opc1> set to 0, <CRn> set to c1, <CRm> set to c0, and <opc2> set to 0. For example:

```
MRC p15,0,<Rt>,c1,c0,0 ; Read CP15 System Control Register
MCR p15,0,<Rt>,c1,c0,0 ; Write CP15 System Control Register
```

Note

Additional configuration and control bits might be added to the SCTL in future versions of the ARM architecture. ARM strongly recommends that software always uses a read, modify, write sequence to update the SCTL. This prevents software modifying any bit that is currently unallocated, and minimizes the chance of the register update having undesired side effects.

B3.12.18 c1, IMPLEMENTATION DEFINED Auxiliary Control Register (ACTLR)

The Auxiliary Control Register, ACTLR, provides implementation-specific configuration and control options.

The ACTLR is:

- A 32-bit read/write register.
- Accessible only in privileged modes.
- When the Security Extensions are implemented, a Banked register. However, some bits might define global configuration settings, and be common to the Secure and Non-secure copies of the register.

The contents of this register are IMPLEMENTATION DEFINED. ARMv7 requires this register to be privileged read/write accessible, even if an implementation has not created any control bits in this register.

Accessing the ACTLR

To access the ACTLR you read or write the CP15 registers with <opc1> set to 0, <CRn> set to c1, <CRm> set to c0, and <opc2> set to 1. For example:

```
MRC p15,0,<Rt>,c1,c0,1 ; Read CP15 Auxiliary Control Register
MCR p15,0,<Rt>,c1,c0,1 ; Write CP15 Auxiliary Control Register
```

B3.12.19 c1, Coprocessor Access Control Register (CPACR)

The Coprocessor Access Control Register, CPACR, controls access to all coprocessors other than CP14 and CP15. It also enables software to check for the presence of coprocessors CP0 to CP13.

The CPACR:

- is a 32-bit read/write register
- is accessible only in privileged modes
- has a defined reset value of 0
- when the Security Extensions are implemented, is a Configurable access register.

The format of the CPACR is:

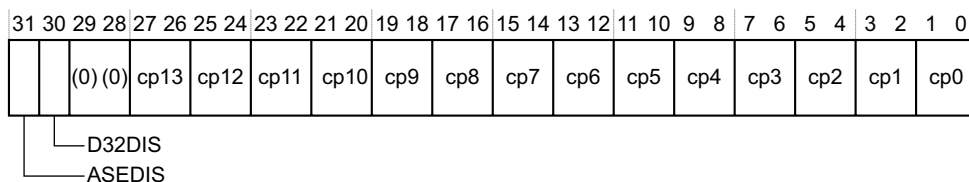

ASEDIS, bit[31]

Disable Advanced SIMD Functionality:

- 0** This bit does not cause any instructions to be UNDEFINED.
- 1** All instruction encodings identified in the *Alphabetical list of instructions* on page A8-14 as being part of Advanced SIMD, but that are not VFPv3 instructions, are UNDEFINED.

On an implementation that:

- Implements VFP and does not implement Advanced SIMD, this bit is RAO/WI.
- Does not implement VFP or Advanced SIMD, this bit is UNK/SBZP.
- Implements both VFP and Advanced SIMD, it is IMPLEMENTATION DEFINED whether this bit is supported. If it is not supported it is RAZ/WI.

This bit resets to 0 if it is supported.

D32DIS, bit[30]

Disable use of D16-D31 of the VFP register file:

- 0** This bit does not cause any instructions to be UNDEFINED.

- 1** All instruction encodings identified in the *Alphabetical list of instructions* on page A8-14 as being VFPv3 instructions are UNDEFINED if they access any of registers D16-D31.

If this bit is 1 when CPACR.ASEDIS == 0, the result is UNPREDICTABLE.

On an implementation that:

- Does not implement VFP, this bit is UNK/SBZP.
- Implements VFP and does not implement D16-D31, this bit is RAO/WI.
- Implements VFP and implements D16-D31, it is IMPLEMENTATION DEFINED whether this bit is supported. If it is not, then this bit is RAZ/WI.

This bit resets to 0 if it is supported.

Bits [29:28] Reserved. UNK/SBZP.

cp<n>, bits [2n+1, 2n], for n = 0 to 13

Defines the access rights for coprocessor n. The possible values of the field are:

- 0b00** Access denied. Any attempt to access the coprocessor generates an Undefined Instruction exception.
- 0b01** Privileged access only. Any attempt to access the coprocessor in User mode generates an Undefined Instruction exception.
- 0b10** Reserved. The effect of this value is UNPREDICTABLE.
- 0b11** Full access. The meaning of full access is defined by the appropriate coprocessor.

The value for a coprocessor that is not implemented is 0b00, access denied.

When the Security Extensions are implemented, the NSACR controls whether each coprocessor can be accessed from the Non-secure state, see *c1, Non-Secure Access Control Register (NSACR)* on page B3-110. When the NSACR permits Non-secure access to a coprocessor the level of access permitted is determined by the CPACR. Because the CPACR is not banked, the options for Non-secure state access to a coprocessor are:

- no access
- identical access rights to the Secure state.

If more than one coprocessor is used to provide a set of functionality then having different values for the CPACR fields for those coprocessors can lead to UNPREDICTABLE behavior. An example where this must be considered is with the VFP extension. This uses CP10 and CP11.

Typically, an operating system uses this register to control coprocessor resource sharing among applications:

- Initially all applications are denied access to the shared coprocessor-based resources.
- When an application attempts to use a resource it results in an Undefined Instruction exception.
- The Undefined Instruction handler can then grant access to the resource by setting the appropriate field in the CPACR.

For details of how this register can be used to check for implemented coprocessors see *Access controls on CP0 to CP13* on page B1-63.

Sharing resources among applications requires a state saving mechanism. Two possibilities are:

- during a context switch, if the last executing process or thread had access rights to a coprocessor then the operating system saves the state of that coprocessor
- on receiving a request for access to a coprocessor, the operating system saves the old state for that coprocessor with the last process or thread that accessed it.

Accessing the CPACR

To access the CPACR you read or write the CP15 registers with <opc1> set to 0, <CRn> set to c1, <CRm> set to c0, and <opc2> set to 2. For example:

```
MRC p15,0,<Rt>,c1,c0,2 ; Read CP15 Coprocessor Access Control Register
MCR p15,0,<Rt>,c1,c0,2 ; Write CP15 Coprocessor Access Control Register
```

Normally, software uses a read, modify, write sequence to update the CPACR, to avoid unwanted changes to the access settings for other coprocessors.

B3.12.20 c1, Secure Configuration Register (SCR)

The Secure Configuration Register, SCR, is part of the Security Extensions.

The SCR defines the configuration of the current security state. It specifies:

- the security state of the processor, Secure or Non-secure
- what mode the processor branches to if an IRQ, FIQ or external abort occurs
- whether the CPSR.F and CPSR.A bits can be modified when SCR.NS = 1.

The SCR:

- is present only when the Security Extensions are implemented
- is a 32-bit read/write register
- is accessible in Secure privileged modes only
- has a defined reset value of 0
- is a Restricted access register, meaning it exists only in the Secure state.

The format of the SCR is:

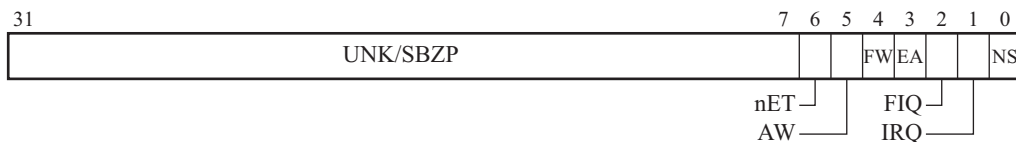

Bits [31:7] Reserved. UNK/SBZP.

- nET, bit [6]** Not Early Termination. This bit disables early termination:
- 0** Early termination permitted. Execution time of data operations can depend on the data values.
 - 1** Disable early termination. The number of cycles required for data operations is forced to be independent of the data values.
- This IMPLEMENTATION DEFINED mechanism can be used to disable data dependent timing optimizations from multiplies and data operations. It can provide system support against information leakage that might be exploited by timing correlation types of attack.
- On implementations that do not have early termination, this bit is UNK/SBZP.
- AW, bit [5]** A bit writable. This bit controls whether the A bit in the CPSR can be modified in Non-secure state:
- 0** the CPSR.A bit can be modified only in Secure state.
 - 1** the CPSR.A bit can be modified in any security state.
- For more information, see *Control of aborts by the Security Extensions* on page B1-41.
- FW, bit [4]** F bit writable. This bit controls whether the F bit in the CPSR can be modified in Non-secure state:
- 0** the CPSR.F bit can be modified only in Secure state
 - 1** the CPSR.F bit can be modified in any security state.
- For more information, see *Control of FIQs by the Security Extensions* on page B1-42.
- EA, bit [3]** External Abort handler. This bit controls which mode handles external aborts:
- 0** Abort mode handles external aborts
 - 1** Monitor mode handles external aborts.
- For more information, see *Control of aborts by the Security Extensions* on page B1-41.
- FIQ, bit [2]** FIQ handler. This bit controls which mode the processor enters when a Fast Interrupt (FIQ) is taken:
- 0** FIQ mode entered when FIQ is taken
 - 1** Monitor mode entered when FIQ is taken.
- For more information, see *Control of FIQs by the Security Extensions* on page B1-42.
- IRQ, bit [1]** IRQ handler. This bit controls which mode the processor enters when an Interrupt (IRQ) is taken:
- 0** IRQ mode entered when IRQ is taken
 - 1** Monitor mode entered when IRQ is taken.

NS, bit [0] Non Secure bit. Except when the processor is in Monitor mode, this bit determines the security state of the processor. Table B3-27 shows the security settings:

Table B3-27 Processor security state

SCR.NS	Processor mode, from CPSR.M bits	
	Monitor mode	All modes except Monitor mode
0	Secure state	Secure state
1	Secure state	Non-secure state

For more information, see *Changing from Secure to Non-secure state* on page B1-27.

The value of the NS bit also affects the accessibility of the Banked CP15 registers in Monitor mode, see *Access to registers in Monitor mode* on page B3-77.

Unless the processor is in Debug state, when an exception occurs in Monitor mode the hardware sets the NS bit to 0.

Whenever the processor changes security state, the monitor code can change the value of the EA, FIQ and H_Q bits. This means that the behavior of IRQ, FIQ and External Abort exceptions can be different in each security state.

Accessing the SCR

To access the SCR you read or write the CP15 registers with <opc1> set to 0, <CRn> set to c1, <CRm> set to c1, and <opc2> set to 0. For example:

```
MRC p15,0,<Rt>,c1,c1,0 ; Read CP15 Secure Configuration Register
MCR p15,0,<Rt>,c1,c1,0 ; Write CP15 Secure Configuration Register
```

B3.12.21 c1, Secure Debug Enable Register (SDER)

The Secure Debug Enable Register, SDER, is part of the Security Extensions.

The SDER controls invasive and non-invasive debug in Secure User mode.

The SDER is:

- present only when the Security Extensions are implemented
- a 32-bit read/write register
- a Restricted access register, meaning it exists only in the Secure state
- accessible in Secure privileged modes only.

The format of the SDER is:

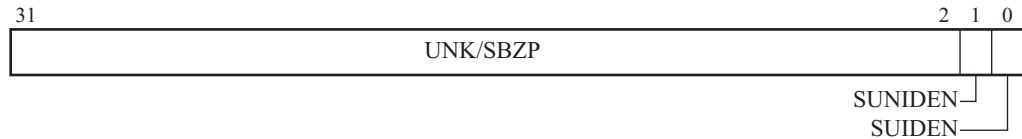

Bits [31:2] Reserved. UNK/SBZP.

SUNIDEN, bit [1]

Secure User Non-Invasive Debug ENable:

- 0** non-invasive debug not permitted in Secure User mode
- 1** non-invasive debug permitted in Secure User mode.

SUIDEN, bit [0]

Secure User Invasive Debug ENable:

- 0** invasive debug not permitted in Secure User mode
- 1** invasive debug permitted in Secure User mode.

For more information about the use of the SUNIDEN and SUIDEN bits see:

- Chapter C2 *Invasive Debug Authentication*
- Chapter C7 *Non-invasive Debug Authentication*.

———— **Note** —————

Invasive and non-invasive debug in Secure privileged modes is controlled by hardware only. For more information, see Chapter C2 *Invasive Debug Authentication* and Chapter C7 *Non-invasive Debug Authentication*.

Accessing the SDER

To access the SDER you read or write the CP15 registers with <opc1> set to 0, <CRn> set to c1, <CRm> set to c1, and <opc2> set to 1. For example:

```
MRC p15,0,<Rt>,c1,c1,1 ; Read CP15 Secure Debug Enable Register
MCR p15,0,<Rt>,c1,c1,1 ; Write CP15 Secure Debug Enable Register
```

B3.12.22 c1, Non-Secure Access Control Register (NSACR)

The Non-Secure Access Control Register, NSACR, is part of the Security Extensions.

The NSACR defines the Non-secure access permissions to the coprocessors CP0 to CP13. Additional IMPLEMENTATION DEFINED bits in the register can be used to define Non-secure access permissions for IMPLEMENTATION DEFINED functionality.

The NSACR is:

- Present only when the Security Extensions are implemented.
- A 32-bit register
- A Restricted access register. NSACR exists only in the Secure state, but can be read from Non-secure state.
- Accessible only in privileged modes, with access rights that depend on the mode and security state:
 - the NSACR is read/write in Secure privileged modes
 - the NSACR is read-only in Non-secure privileged modes.

The format of the NSACR is:

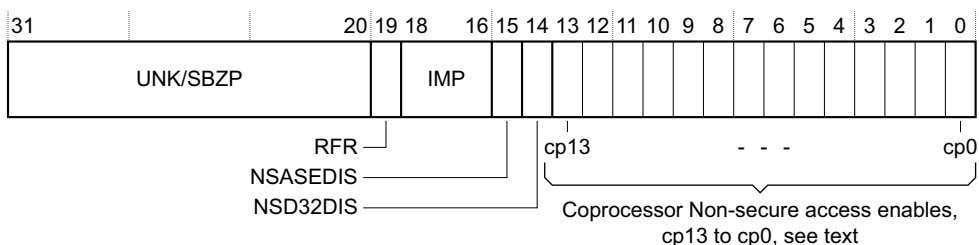

Bits [31:20]

Reserved. UNK/SBZP.

RFR, bit [19] Reserve FIQ Registers:

- 0** FIQ mode and the FIQ banked registers are accessible in Secure and Non-secure security states.
- 1** FIQ mode and the FIQ banked registers are accessible in the Secure security state only. Any attempt to access any FIQ Banked register or to enter an FIQ mode when in the Non-secure security states is UNPREDICTABLE.

This bit resets to 0. On some implementations this bit cannot be set to 1.

If NSACR.RFR == 1 when SCR.FIQ == 0, instruction execution is UNPREDICTABLE in Non-secure security state.

Bits [18:16] IMPLEMENTATION DEFINED.

These bits can be used to define the Non-secure access to IMPLEMENTATION DEFINED features.

NSASEDIS, bit[15]

Disable Non-secure Advanced SIMD functionality:

- 0** This bit has no effect on the ability to write CPACR.ASEDIS.
- 1** When executing in Non-secure state the CPACR.ASEDIS bit has a fixed value of 1 and writes to it are ignored.

On an implementation that:

- Implements VFP and does not implement Advanced SIMD, this bit is RAO/WI.
- Does not implement VFP or Advanced SIMD, this bit is UNK/SBZP.
- Implements both VFP and Advanced SIMD, it is IMPLEMENTATION DEFINED whether this bit is supported. If it is not supported it is RAZ/WI.

This bit resets to 0 if it is supported.

NSD32DIS, bit[14]

Disable Non-secure use of D16-D31 of the VFP register file:

- 0** This bit has no effect on the ability to write CPACR.D32DIS.
- 1** When executing in Non-secure state, the CPACR.D32DIS bit has a fixed value of 1 and writes to it are ignored.

If this bit is 1 when NSACR.NSASEDIS == 0, the result is UNPREDICTABLE.

On an implementation that:

- Does not implement VFP, this bit is UNK/SBZP.
- Implements VFP and does not implement D16-D31, this bit is RAO/WI.
- Implements VFP and implements D16-D31, it is IMPLEMENTATION DEFINED whether this bit is supported. If it is not supported it is RAZ/WI.

This bit resets to 0 if it is supported.

cp<n>, bit [n], for n = 0 to 13

Non-secure access to coprocessor <n> enable. Each bit enables access to the corresponding coprocessor from Non-secure state:

- 0** Coprocessor <n> can be accessed only from Secure state. Any attempt to access coprocessor <n> in Non-secure state results in an Undefined Instruction exception.

If the processor is in Non-secure state it cannot write the corresponding bits in the CPACR, and reads them as 0b00, access denied.

- 1** Coprocessor <n> can be accessed from any security state.

If Non-secure access to a coprocessor is enabled, the CPACR must be checked to determine the level of access that is permitted, see *c1, Coprocessor Access Control Register (CPACR)* on page B3-104.

If multiple coprocessors are used to control a feature then the Non-secure access enable bits for those coprocessors must be set to the same value, otherwise behavior is UNPREDICTABLE. For example, when the VFP extension is implemented it is controlled by coprocessors 10 and 11, and bits [10,11] of the NSACR must be set to the same value.

For bits that correspond to coprocessors that are not implemented, it is IMPLEMENTATION DEFINED whether the bits:

- behave as RAZ/WI
- can be written by Secure privileged modes.

Accessing the NSACR

To access the NSACR you read or write the CP15 registers with <opc1> set to 0, <CRn> set to c1, <CRm> set to c1, and <opc2> set to 2. For example:

```
MRC p15,0,<Rt>,c1,c1,2 ; Read CP15 Non-Secure Access Control Register
MCR p15,0,<Rt>,c1,c1,2 ; Write CP15 Non-Secure Access Control Register
```

You can write to the NSACR only in Secure privileged modes.

You can read the register in any privileged mode.

B3.12.23 CP15 c2 and c3, Memory protection and control registers

On an ARMv7-A implementation, the CP15 c2 and c3 registers are used for memory protection and control. Figure B3-14 shows these registers.



Figure B3-14 CP15 c2 and c3 registers

CP15 c2 and c3 register encodings not shown in Figure B3-14 are UNPREDICTABLE, see *Unallocated CP15 encodings* on page B3-69.

B3.12.24 CP15 c2, Translation table support registers

When the VMSA is implemented, three translation table support registers are implemented in CP15 c2. Table B3-28 summarizes these registers.

Table B3-28 VMSA translation table support registers

Register name	Description
Translation Table Base 0	<i>c2, Translation Table Base Register 0 (TTBR0)</i>
Translation Table Base 1	<i>c2, Translation Table Base Register 1 (TTBR1)</i> on page B3-116
Translation Table Base Control	<i>c2, Translation Table Base Control Register (TTBCR)</i> on page B3-117

The description of the TTBCR describes the use of this set of registers, see *c2, Translation Table Base Control Register (TTBCR)* on page B3-117.

c2, Translation Table Base Register 0 (TTBR0)

The Translation Table Base Register 0, TTBR0, holds the base address of translation table 0, and information about the memory it occupies.

The TTBR0 register:

- is a 32-bit read/write register
- is accessible only in privileged modes
- when the Security Extensions are implemented:
 - is a Banked register.
 - has write access to the Secure copy of the register disabled when the **CP15SDISABLE** signal is asserted HIGH.

When the Multiprocessing Extensions are not implemented, the format of the TTBR0 register is:

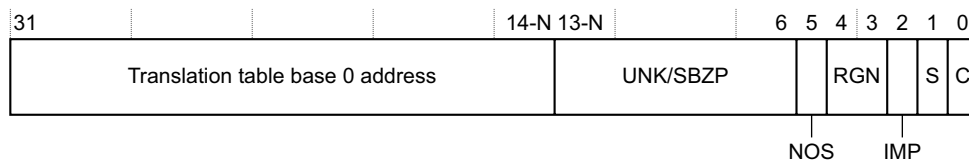

When the Multiprocessing Extensions are implemented, the format of the TTBR0 register is:

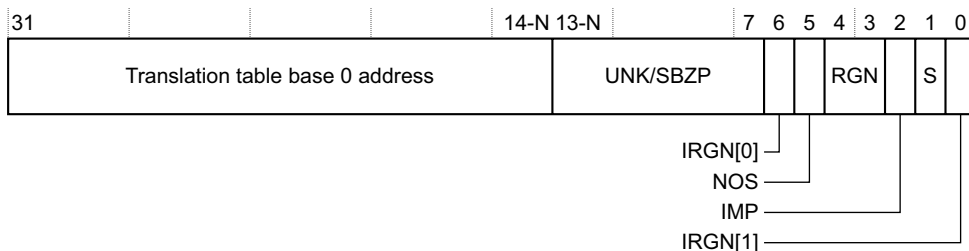

Bits [31:14-N] Translation table base 0 address, bits [31:14-N].

The value of N determines the required alignment of the translation table, which must be aligned to 2^{14-N} bytes.

Bits [13-N:6], ARMv7-A base architecture

UNK/SBZP.

Bits [13-N:7], when the Multiprocessing Extensions are implemented

UNK/SBZP.

IRGN[0], bit [6], when the Multiprocessing Extensions are implemented

See the description of bit [0] when the Multiprocessing Extensions are implemented.

NOS, bit [5] Not Outer Shareable bit. Indicates the Outer Shareable attribute for the memory associated with a translation table walk that has the Shareable attribute, indicated by $TTBR0.S == 1$:

0 Outer Shareable

1 Inner Shareable.

This bit is ignored when $TTBR0.S == 0$.

This bit is only implemented from ARMv7⁺.

RGN, bits [4:3]

Region bits. Indicates the Outer Cacheability attributes for the memory associated with the translation table walks:

0b00 Normal memory, Outer Non-cacheable

0b01 Normal memory, Outer Write-Back Write-Allocate Cacheable

- 0b10** Normal memory, Outer Write-Through Cacheable
0b11 Normal memory, Outer Write-Back no Write-Allocate Cacheable.

IMP, bit [2] The effect of this bit is IMPLEMENTATION DEFINED. If the translation table implementation does not include any IMPLEMENTATION DEFINED features this bit is SBZ.

S, bit [1] Shareable bit. Indicates the Shareable attribute for the memory associated with the translation table walks:

- 0** Non-shareable
1 Shareable.

C, bit [0], ARMv7-A base architecture

Cacheable bit. Indicates whether the translation table walk is to Inner Cacheable memory.

- 0** Inner Non-cacheable
1 Inner Cacheable.

For regions marked as Inner Cacheable, it is IMPLEMENTATION DEFINED whether the read has the Write-Through, Write-Back no Write-Allocate, or Write-Back Write-Allocate attribute.

IRGN, bits [6,0], when the Multiprocessing Extensions are implemented

Inner region bits. Indicates the Inner Cacheability attributes for the memory associated with the translation table walks. The possible values of IRGN[1:0] are:

- 0b00** Normal memory, Inner Non-cacheable
0b01 Normal memory, Inner Write-Back Write-Allocate Cacheable
0b10 Normal memory, Inner Write-Through Cacheable
0b11 Normal memory, Inner Write-Back no Write-Allocate Cacheable.

Note

The encoding of the IRGN bits is counter-intuitive, with register bit [6] being IRGN[0] and register bit [0] being IRGN[1]. This encoding is chosen to give a consistent encoding of memory region types and to ensure that software written for the ARMv7 base architecture can run unmodified on an implementation that includes the Multiprocessing Extensions.

Accessing the TTBR0 register

To access the TTBR0 register you read or write the CP15 registers with <opc1> set to 0, <CRn> set to c2, <CRm> set to c0, and <opc2> set to 0. For example:

```
MRC p15,0,<Rt>,c2,c0,0 ; Read CP15 Translation Table Base Register 0
MCR p15,0,<Rt>,c2,c0,0 ; Write CP15 Translation Table Base Register 0
```

c2, Translation Table Base Register 1 (TTBR1)

The Translation Table Base Register 1, TTBR1, holds the base address of translation table 1, and information about the memory it occupies.

The TTBR1 register is:

- a 32-bit read/write register
- accessible only in privileged modes
- when the Security Extensions are implemented, a Banked register.

When the Multiprocessing Extensions are not implemented, the format of the TTBR1 register is:

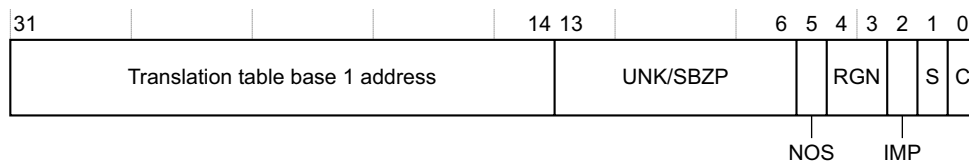

When the Multiprocessing Extensions are implemented, the format of the TTBR1 register is:

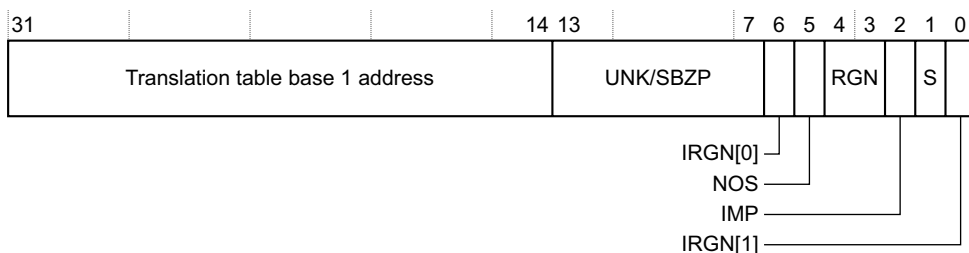

Bits [31:14] Translation table base 1 address, bits [31:14]. The translation table must be aligned on a 16KByte boundary.

Bits [13:6], ARMv7-A base architecture

UNK/SBZP.

Bits [13:7], when the Multiprocessing Extensions are implemented

UNK/SBZP.

IRGN[0:1], bits [6,0], when the Multiprocessing Extensions are implemented

See the definition given for the TTBR0 in *c2, Translation Table Base Register 0 (TTBR0)* on page B3-113.

NOS, RGN, IMP, S, bits [5:1]

See the definitions given for the TTBR0 in *c2, Translation Table Base Register 0 (TTBR0)* on page B3-113.

C, bit [0], ARMv7-A base architecture

See the definition given for the TTBR0 in *c2, Translation Table Base Register 0 (TTBR0)* on page B3-113.

Accessing the TTBR1 register

To access the TTBR1 register you read or write the CP15 registers with <opc1> set to 0, <CRn> set to c2, <CRm> set to c0, and <opc2> set to 1. For example:

```
MRC p15,0,<Rt>,c2,c0,1    ; Read CP15 Translation Table Base Register 1
MCR p15,0,<Rt>,c2,c0,1    ; Write CP15 Translation Table Base Register 1
```

c2, Translation Table Base Control Register (TTBCR)

The Translation Table Base Control Register, TTBCR, determines which of the Translation Table Base Registers, TTBR0 or TTBR1, defines the base address for the translation table walk that is required when an MVA is not found in the TLB.

The TTBCR:

- Is a 32-bit read/write register.
- Is accessible only in privileged modes
- Has a defined reset value of 0. When the Security Extensions are implemented, this reset value applies only to the Secure copy of the register, and software must program the Non-secure copy of the register with the required value.
- When the Security Extensions are implemented:
 - is a Banked register.
 - has write access to the Secure copy of the register disabled when the **CP15SDISABLE** signal is asserted HIGH.

When the Security Extensions are not implemented, the format of the TTBCR is:



When the Security Extensions are implemented, the format of the TTBCR is:

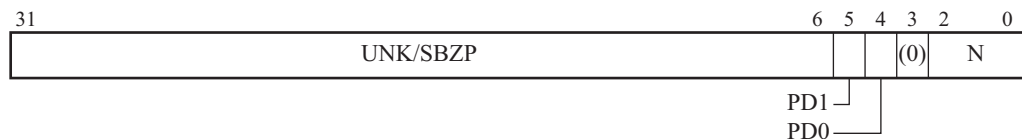

Bits [31:6, 3] UNK/SBZP.

PD1, bit [5], when Security Extensions are implemented

Translation table walk Disable bit for TTBR1. This bit controls whether a translation table walk is performed on a TLB miss when TTBR1 is used:

- 0** If a TLB miss occurs when TTBR1 is used a translation table walk is performed.

- 1** If a TLB miss occurs when TTBR1 is used no translation table walk is performed and a Section Translation fault is returned.

PD0, bit [4], when Security Extensions are implemented

Translation table walk Disable bit for TTBR0. This bit controls whether a translation table walk is performed on a TLB miss when TTBR0 is used. The meanings of the possible values of this bit are equivalent to those for the PD1 bit.

Bits [5:4], when Security Extensions are not implemented

UNK/SBZP.

N, bits [2:0] Indicate the width of the base address held in TTBR0. In TTBR0, the base address field is bits [31:14-N]. The value of N also determines:

- whether TTBR0 or TTBR1 is used as the base address for translation table walks.
- the size of the translation table pointed to by TTBR0.

N can take any value from 0 to 7, that is, from 0b000 to 0b111.

When N has its reset value of 0, the translation table base is compatible with ARMv5 and ARMv6.

Determining which TTBR to use, and the TTBR0 translation table size

When an MVA is not found in the TLB, the value of TTBCR.N determines whether TTBR0 or TTBR1 is used as the base address for the translation table walk in memory:

- if N == 0 then always use TTBR0
- if N > 0 then:
 - if bits [31:32-N] of the MVA are all zero then use TTBR0
 - otherwise use TTBR1.

The size of the first-level translation tables accessed by TTBR0 depends on the value of TTBCR.N as shown in Table B3-29:

Table B3-29 Value of N field and the size of the TTBR0 translation table

TTBCR.N	Size of TTBR0 translation table
0b000	16KB
0b001	8KB
0b010	4KB
0b011	2KB
0b100	1KB

Table B3-29 Value of N field and the size of the TTBR0 translation table (continued)

TTBCR.N	Size of TTBR0 translation table
0b101	512 bytes
0b110	256 bytes
0b111	128 bytes

Accessing the TTBCR

To access the TTBCR you read or write the CP15 registers with <opc1> set to 0, <CRn> set to c2, <CRm> set to c0, and <opc2> set to 2. For example:

```
MRC p15,0,<Rt>,c2,c0,2 ; Read CP15 Translation Table Base Control Register
MCR p15,0,<Rt>,c2,c0,2 ; Write CP15 Translation Table Base Control Register
```

B3.12.25 c3, Domain Access Control Register (DACR)

The Domain Access Control Register, DACR, defines the access permission for each of the sixteen memory domains.

The DACR:

- is a 32-bit read/write register
- is accessible only in privileged modes
- when the Security Extensions are implemented:
 - is a Banked register.
 - has write access to the Secure copy of the register disabled when the **CP15SDISABLE** signal is asserted HIGH.

The format of the DACR is:

31	30	29	28	27	26	25	24	23	22	21	20	19	18	17	16	15	14	13	12	11	10	9	8	7	6	5	4	3	2	1	0
D15	D14	D13	D12	D11	D10	D9	D8	D7	D6	D5	D4	D3	D2	D1	D0																

Dn, bits [(2n+1):2n]

Domain n access permission, where n = 0 to 15. Permitted values are:

- 0b00** No access. Any access to the domain generates a Domain fault.
- 0b01** Client. Accesses are checked against the permission bits in the translation tables.
- 0b10** Reserved, effect is UNPREDICTABLE
- 0b11** Manager. Accesses are not checked against the permission bits in the translation tables.

For more information, see *Domains* on page B3-31.

Accessing the DACR

To access the DACR you read or write the CP15 registers with <opc1> set to 0, <CRn> set to c3, <CRm> set to c0, and <opc2> set to 0. For example:

```
MRC p15,0,<Rt>,c3,c0,0 ; Read CP15 Domain Access Control Register
MCR p15,0,<Rt>,c3,c0,0 ; Write CP15 Domain Access Control Register
```

B3.12.26 CP15 c4, Not used

CP15 c4 is not used on any ARMv7 implementation, see *Unallocated CP15 encodings* on page B3-69.

B3.12.27 CP15 c5 and c6, Memory system fault registers

The CP15 c5 and c6 registers are used for memory system fault reporting. Figure B3-15 shows the CP15 c5 and c6 registers.

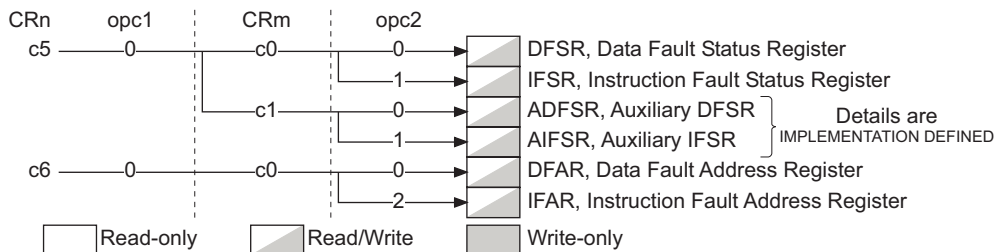

Figure B3-15 CP15 c5 and c6 registers in a VMSA implementation

CP15 c5 and c6 register encodings not shown in Figure B3-15 are UNPREDICTABLE, see *Unallocated CP15 encodings* on page B3-69.

The CP15 c5 and c6 registers are described in:

- *CP15 c5, Fault status registers* on page B3-121
- *CP15 c6, Fault Address registers* on page B3-124.

Also, these registers are used to report information about debug exceptions. For details see *Effects of debug exceptions on CP15 registers and the DBGWFAR* on page C4-4.

B3.12.28 CP15 c5, Fault status registers

There are two fault status registers, in CP15 c5, and the architecture provides encodings for two additional IMPLEMENTATION DEFINED registers. Table B3-30 summarizes these registers.

Table B3-30 Fault status registers

Register name	Description
Data Fault Status Register (DFSR)	<i>c5, Data Fault Status Register (DFSR)</i>
Instruction Fault Status Register (IFSR)	<i>c5, Instruction Fault Status Register (IFSR) on page B3-122</i>
Auxiliary Data Fault Status Register (ADFSR)	<i>c5, Auxiliary Data and Instruction Fault Status Registers (ADFSR and AIFSR) on page B3-123</i>
Auxiliary Instruction Fault Status Register (AIFSR)	

Fault information is returned using the fault status registers and the fault address registers described in *CP15 c6, Fault Address registers* on page B3-124. For details of how these registers are used see *Fault Status and Fault Address registers in a VMSA implementation* on page B3-48.

c5, Data Fault Status Register (DFSR)

The Data Fault Status Register, DFSR, holds status information about the last data fault.

The DFSR is:

- a 32-bit read/write register
- accessible only in privileged modes
- when the Security Extensions are implemented, a Banked register.

The format of the DFSR is:

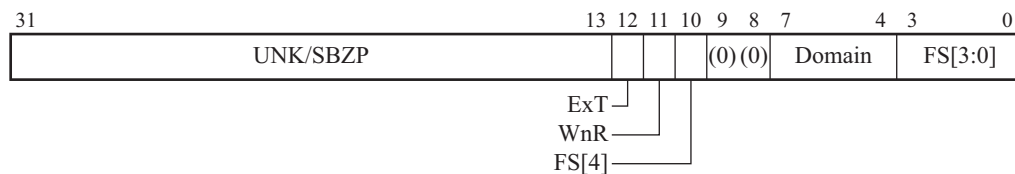

Bits [31:13,9:8]

UNK/SBZP.

ExT, bit [12] External abort type. This bit can be used to provide an IMPLEMENTATION DEFINED classification of external aborts.

For aborts other than external aborts this bit always returns 0.

WnR, bit [11] Write not Read bit. Indicates whether the abort was caused by a write or a read access:

- 0** Abort caused by a read access
- 1** Abort caused by a write access.

For faults on CP15 cache maintenance operations, including the VA to PA translation operations, this bit always returns a value of 1.

FS, bits [10,3:0]

Fault status bits. For the valid encodings of these bits in an ARMv7-A implementation with a VMSA, see Table B3-12 on page B3-51.

All encodings not shown in the table are reserved.

Domain, bits [7:4]

The domain of the fault address.

From ARMv7 use of this field is deprecated, see *The Domain field in the DFSR* on page B3-52.

For information about using the DFSR see *Fault Status and Fault Address registers in a VMSA implementation* on page B3-48.

Accessing the DFSR

To access the DFSR you read or write the CP15 registers with <opc1> set to 0, <CRn> set to c5, <CRm> set to c0, and <opc2> set to 0. For example:

```
MRC p15,0,<Rt>,c5,c0,0 ; Read CP15 Data Fault Status Register
MCR p15,0,<Rt>,c5,c0,0 ; Write CP15 Data Fault Status Register
```

c5, Instruction Fault Status Register (IFSR)

The Instruction Fault Status Register, IFSR, holds status information about the last instruction fault.

The IFSR is:

- a 32-bit read/write register
- accessible only in privileged modes
- when the Security Extensions are implemented, a Banked register.

The format of the IFSR is:

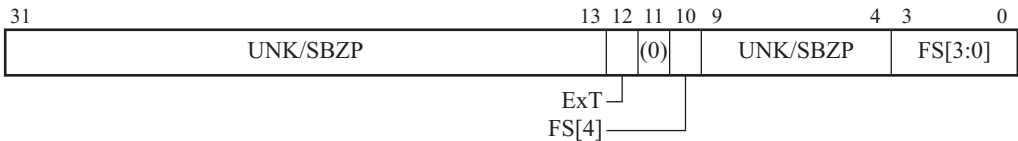

Bits [31:13,11,9:4]

UNK/SBZP.

ExT, bit [12] External abort type. This bit can be used to provide an IMPLEMENTATION DEFINED classification of external aborts.

For aborts other than external aborts this bit always returns 0.

FS, bits [10,3:0]

Fault status bits. For the valid encodings of these bits in an ARMv7-A implementation with a VMSA, see Table B3-11 on page B3-50.

All encodings not shown in the table are reserved.

For information about using the IFSR see *Fault Status and Fault Address registers in a VMSA implementation* on page B3-48.

Accessing the IFSR

To access the IFSR you read or write the CP15 registers with <opc1> set to 0, <CRn> set to c5, <CRm> set to c0, and <opc2> set to 1. For example:

```
MRC p15,0,<Rt>,c5,c0,1    ; Read CP15 Instruction Fault Status Register
MCR p15,0,<Rt>,c5,c0,1    ; Write CP15 Instruction Fault Status Register
```

c5, Auxiliary Data and Instruction Fault Status Registers (ADFSR and AIFSR)

The Auxiliary Data Fault Status Register (ADFSR) and the Auxiliary Instruction Fault Status Register (AIFSR) enable the system to return additional IMPLEMENTATION DEFINED fault status information, see *Auxiliary Fault Status Registers* on page B3-53.

The ADFSR and AIFSR are:

- 32-bit read/write registers
- accessible only in privileged modes
- when the Security Extensions are implemented, Banked registers
- introduced in ARMv7.

The formats of the ADFSR and AIFSR are IMPLEMENTATION DEFINED.

Accessing the ADFSR and AIFSR

To access the ADFSR or AIFSR you read or write the CP15 registers with <opc1> set to 0, <CRn> set to c5, <CRm> set to c1, and <opc2> set to:

- 0 for the ADFSR
- 1 for the AIFSR.

For example:

```
MRC p15,0,<Rt>,c5,c1,0    ; Read CP15 Auxiliary Data Fault Status Register
MCR p15,0,<Rt>,c5,c1,0    ; Write CP15 Auxiliary Data Fault Status Register
MRC p15,0,<Rt>,c5,c1,1    ; Read CP15 Auxiliary Instruction Fault Status Register
MCR p15,0,<Rt>,c5,c1,1    ; Write CP15 Auxiliary Instruction Fault Status Register
```

B3.12.29 CP15 c6, Fault Address registers

There are two Fault Address registers, in CP15 c6, as shown in Figure B3-15 on page B3-120s. The two Fault Address registers complement the Fault Status registers, and are shown in Table B3-31.

Table B3-31 Fault Address registers

Register name	Description
Data Fault Address Register (DFAR)	<i>c6, Data Fault Address Register (DFAR)</i>
Instruction Fault Address Register (IFAR)	<i>c6, Instruction Fault Address Register (IFAR) on page B3-125</i>

Note

Before ARMv7:

- The DFAR was called the Fault Address Register (FAR).
- The Watchpoint Fault Address Register (DBGWFAR) was implemented in CP15 c6, with <opc2> = 1. From ARMv7, the DBGWFAR is only implemented as a CP14 debug register, see *Watchpoint Fault Address Register (DBGWFAR)* on page C10-28.

Fault information is returned using the fault address registers and the fault status registers described in *CP15 c5, Fault status registers* on page B3-121. For details of how these registers are used, and when the value in the IFAR is valid, see *Fault Status and Fault Address registers in a VMSA implementation* on page B3-48.

c6, Data Fault Address Register (DFAR)

The Data Fault Address Register, DFAR, holds the MVA of the faulting address that caused a synchronous Data Abort exception.

The DFAR is:

- a 32-bit read/write register
- accessible only in privileged modes
- when the Security Extensions are implemented, a Banked register.

The format of the DFAR is:

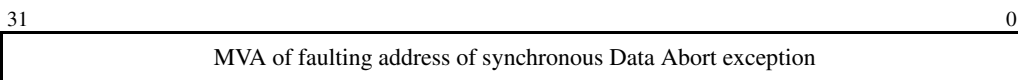

For information about using the DFAR, and when the value in the DFAR is valid, see *Fault Status and Fault Address registers in a VMSA implementation* on page B3-48.

A debugger can write to the DFAR to restore its value.

Accessing the DFAR

To access the DFAR you read or write the CP15 registers with <opc1> set to 0, <CRn> set to c6, <CRm> set to c0, and <opc2> set to 0. For example:

```
MRC p15,0,<Rt>,c6,c0,0 ; Read CP15 Data Fault Address Register
MCR p15,0,<Rt>,c6,c0,0 ; Write CP15 Data Fault Address Register
```

c6, Instruction Fault Address Register (IFAR)

The Instruction Fault Address Register, IFAR, holds the MVA of the faulting access that caused a synchronous Prefetch Abort exception.

The IFAR is:

- a 32-bit read/write register
- accessible only in privileged modes
- when the Security Extensions are implemented, a Banked register.

The format of the IFAR is:

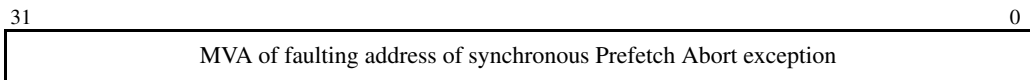

For information about using the IFAR see *Fault Status and Fault Address registers in a VMSA implementation* on page B3-48.

A debugger can write to the IFAR to restore its value.

Accessing the IFAR

To access the IFAR you read or write the CP15 registers with <opc1> set to 0, <CRn> set to c6, <CRm> set to c0, and <opc2> set to 2. For example:

```
MRC p15,0,<Rt>,c6,c0,2 ; Read CP15 Instruction Fault Address Register
MCR p15,0,<Rt>,c6,c0,2 ; Write CP15 Instruction Fault Address Register
```

B3.12.30 CP15 c7, Cache maintenance and other functions

The CP15 c7 registers are used for cache maintenance operations. They also provide barrier operations, and VA to PA address translation functions. Figure B3-16 shows the CP15 c7 registers.

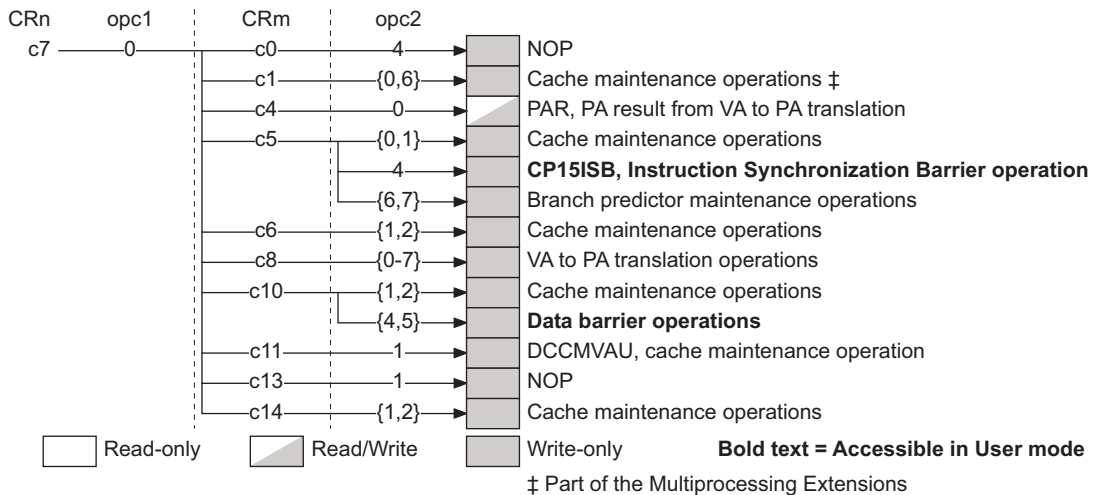

Figure B3-16 CP15 c7 registers in a VMSA implementation

CP15 c7 register encodings not shown in Figure B3-16 are UNPREDICTABLE, see *Unallocated CP15 encodings* on page B3-69.

The CP15 c7 registers are described in:

- *CP15 c7, Cache and branch predictor maintenance functions*
- *CP15 c7, Virtual Address to Physical Address translation operations* on page B3-130
- *CP15 c7, Miscellaneous functions* on page B3-136.

B3.12.31 CP15 c7, Cache and branch predictor maintenance functions

CP15 c7 provides a number of functions. This section describes only the CP15 c7 cache and branch predictor maintenance operations. Branch predictor operations are included in this section because they operate in a similar way to the cache maintenance operations.

Note

ARMv7 introduces significant changes in the CP c7 operations. Most of these changes are because, from ARMv7, the architecture covers multiple levels of cache. This section only describes the ARMv7 requirements for these operations. For details of these operations in previous versions of the architecture see:

- *c7, Cache operations* on page AppxG-38 for ARMv6
- *c7, Cache operations* on page AppxH-49 for ARMv4 and ARMv5.

Figure B3-17 shows the CP15 c7 cache and branch predictor maintenance operations.

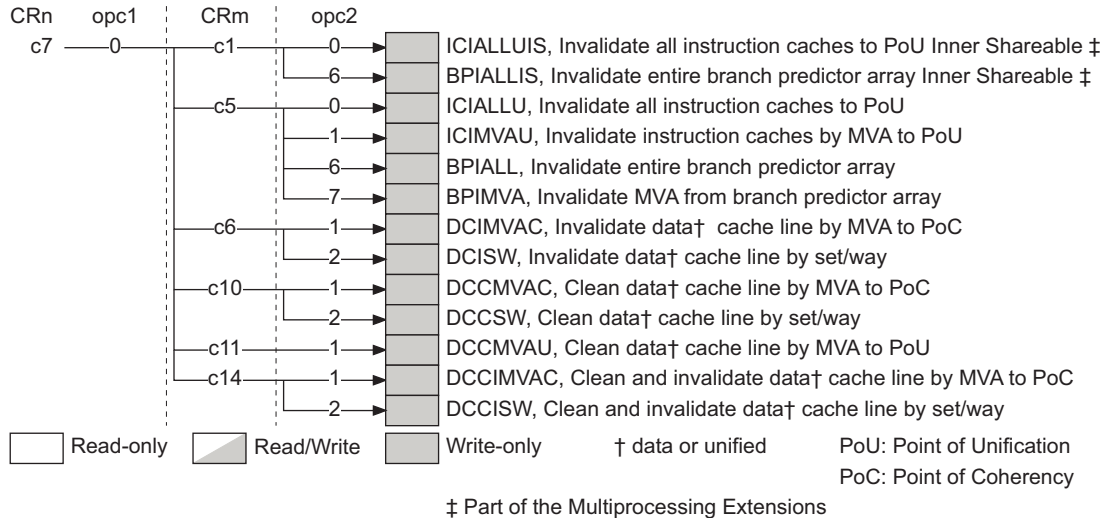

Figure B3-17 CP15 c7 Cache and branch predictor maintenance operations

The CP15 c7 cache and branch predictor maintenance operations are all write-only operations that can be executed only in privileged modes. They are listed in Table B3-32.

For more information about the terms used in this section see *Terms used in describing cache operations* on page B2-10. The Multiprocessing Extensions changes the set of caches affected by these operations, *Multiprocessor effects on cache maintenance operations* on page B2-23.

In Table B3-32, the *Rt data* column specifies what data is required in the register *Rt* specified by the MCR instruction used to perform the operation. For more information about the possible data formats, see *Data formats for the cache and branch predictor operations* on page B3-128.

Table B3-32 CP15 c7 cache and branch predictor maintenance operations

CRm	opc2	Mnemonic	Function ^a	Rt data
c1	0	ICIALUIS ^b	Invalidate all instruction caches Inner Shareable to PoU. Also flushes branch target cache. ^c	Ignored
c1	6	BPIALLIS ^b	Invalidate entire branch predictor array Inner Shareable.	Ignored
c5	0	ICIALLU	Invalidate all instruction caches to PoU. Also flushes branch target cache. ^c	Ignored
c5	1	ICIMVAU	Invalidate instruction cache line by MVA to PoU. ^c	MVA
c5	6	BPIALL	Invalidate entire branch predictor array.	Ignored

Table B3-32 CP15 c7 cache and branch predictor maintenance operations (continued)

CRm	opc2	Mnemonic	Function ^a	Rt data
c5	7	BPIMVA	Invalidate MVA from branch predictor array.	MVA
c6	1	DCIMVAC	Invalidate data or unified cache line by MVA to PoC.	MVA
c6	2	DCISW	Invalidate data or unified cache line by set/way.	Set/way
c10	1	DCCMVAC	Clean data or unified cache line by MVA to PoC.	MVA
c10	2	DCCSW	Clean data or unified cache line by set/way.	Set/way
c11	1	DCCMVAU	Clean data or unified cache line by MVA to PoU.	MVA
c14	1	DCCIMVAC	Clean and Invalidate data or unified cache line by MVA to PoC.	MVA
c14	2	DCCISW	Clean and Invalidate data or unified cache line by set/way.	Set/way

- a. *Modified Virtual Address (MVA), point of coherency (PoC) and point of unification (PoU)* are described in *Terms used in describing cache operations* on page B2-10.
- b. Part of the Multiprocessing Extensions, See *Multiprocessor effects on cache maintenance operations* on page B2-23.
- c. Only applies to separate instruction caches, does not apply to unified caches.

Data formats for the cache and branch predictor operations

Table B3-32 on page B3-127 shows three possibilities for the data in the register Rt specified by the MCR instruction. These are described in the following subsections:

- *Ignored*
- *MVA*
- *Set/way* on page B3-129.

Ignored

The value in the register specified by the MCR instruction is ignored. You do not have to write a value to the register before issuing the MCR instruction.

MVA

For more information about the possible meaning when the table shows that an MVA is required see *Terms used in describing cache operations* on page B2-10. When the data is stated to be an MVA, it does not have to be cache line aligned.

Set/way

For an operation by set/way, the data identifies the cache line that the operation is to be applied to by specifying:

- the cache set the line belongs to
- the way number of the line in the set
- the cache level.

The format of the register data for a set/way operation is:

31	32-A	31-A	B	B-1	L	L-1	4	3	1	0
Way		SBZ		Set		SBZ		Level		0

Where:

A = $\text{Log}_2(\text{ASSOCIATIVITY})$

B = $(L + S)$

L = $\text{Log}_2(\text{LINELEN})$

S = $\text{Log}_2(\text{NSETS})$

ASSOCIATIVITY, LINELEN (Line Length) and NSETS (number of sets) have their usual meanings and are the values for the cache level being operated on.

The values of A and S are rounded up to the next integer.

Level ((Cache level to operate on) -1)

For example, this field is 0 for operations on L 1 cache, or 1 for operations on L 2 cache.

Set The number of the set to operate on.

Way The number of the way to operate on.

———— **Note** —————

- If L = 4 then there is no SBZ field between the set and level fields in the register.
- If A = 0 there is no way field in the register, and register bits [31:B] are SBZ.
- If the level, set or way field in the register is larger than the size implemented in the cache then the effect of the operation is UNPREDICTABLE.

Accessing the CP15 c7 cache and branch predictor maintenance operations

To perform one of the cache maintenance operations you write the CP15 registers with <opc1> set to 0, <CRn> set to c7, and <CRm> and <opc2> set to the values shown in Table B3-32 on page B3-127.

That is:

MCR p15,0,<Rt>,c7,<CRm>,<opc2>

For example:

MCR p15,0,<Rt>,c7,c5,0 ; Invalidate all instruction caches to point of unification

MCR p15,0,<Rt>,c7,c10,2 ; Clean data or unified cache line by set/way

B3.12.32 CP15 c7, Virtual Address to Physical Address translation operations

CP15 c7 provides a number of functions, summarized in Figure B3-10 on page B3-65. This section describes only the CP15 c7 operations that provide *Virtual Address* (VA) to *Physical Address* (PA) translation on implementations that include the VMSA, and the register that returns the result of the operation.

Figure B3-18 shows all of the CP15 c7 VA to PA translation operations. It does not show the other CP15 c7 operations.

Note

As explained in this section, the CP15 c7 encodings for VA to PA translation with $\langle \text{opc2} \rangle = \{4-7\}$ are available only when the Security Extensions are implemented. These encodings are reserved and UNPREDICTABLE when the Security Extensions are not implemented.

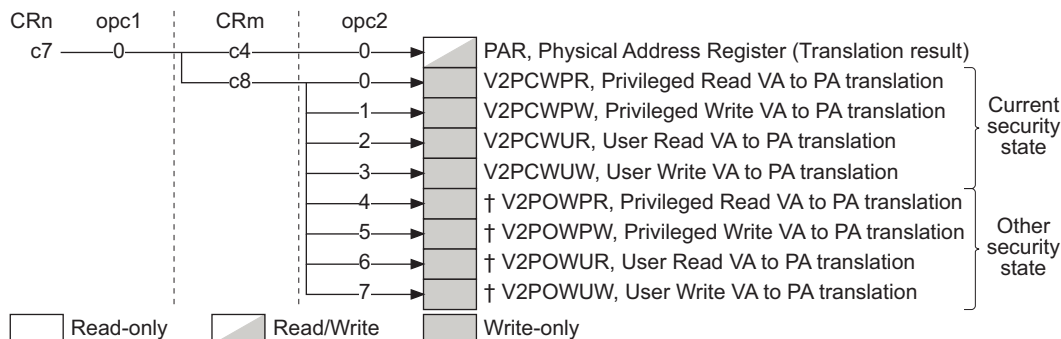

Shown with Security Extensions implemented. When they are not implemented:

- the concepts of *Current security state* and *Other security state* are not defined
- encodings marked † are reserved and UNPREDICTABLE.

Figure B3-18 CP15 c7 VA to PA translation operations

This set of registers comprises:

- A single Physical Address Register, PAR, that returns the result of the VA to PA translation. For more information about this register see *c7, Physical Address Register (PAR) and VA to PA translations* on page B3-133.
- A set of VA to PA translation operations. These are:
 - 32-bit write-only operations
 - accessible only in privileged modes.

When the Security Extensions are not implemented, there are four VA to PA translation operations, listed in Table B3-33.

Table B3-33 VA to PA translation when Security Extensions are not implemented



CRm	opc2	Mnemonic	Register or operation
c4	0	-	PAR, Physical Address Register
c8	0	V2PCWPR	Privileged read VA to PA translation
c8	1	V2PCWPW	Privileged write VA to PA translation
c8	2	V2PCWUR	User read VA to PA translation
c8	3	V2PCWUW	User write VA to PA translation

When the Security Extensions are implemented, there are eight VA to PA translation operations. Four of these are common to the Secure and Non-secure security states, and four are only available in the Secure state. Table B3-34 lists these operations, and shows the security states in which each is available.

Table B3-34 VA to PA translation when Security Extensions are implemented

Register or operation:						
CRm	opc2	Mnemonic	Common	Non-secure state	Secure state	
c4	0	-	-	PAR	PAR	
c8	0	V2PCWPR	Current security state privileged read ^a	-	-	
c8	1	V2PCWPW	Current security state privileged write ^a	-	-	
c8	2	V2PCWUR	Current security state User read ^a	-	-	
c8	3	V2PCWUW	Current security state User write ^a	-	-	
c8	4	V2POWPR	-	<u>1</u>	-	Other security state privileged read ^a

Table B3-34 VA to PA translation when Security Extensions are implemented (continued)

Register or operation:					
CRm	opc2	Mnemonic	Common	Non-secure state	Secure state
c8	5	V2POWPW	-		Other security state privileged write ^a
c8	6	V2POWUR	-		Other security state User read ^a
c8	7	V2POWUW	-		Other security state User write ^a

a. VA to PA Translation operations.

Writing a VA to a VA to PA translation operation encoding translates the VA to the corresponding PA. The PA value is returned in the PAR. These operations are accessible only in privileged modes. The available VA to PA translations depend on:

- whether the Security Extensions are implemented
- if the Security Extensions are implemented, whether the processor is in the Secure or Non-secure state.

In more detail:

Security Extensions not implemented

Four VA to PA translation operations are available, as shown in Table B3-33 on page B3-131. These operations provide VA to PA translation for privileged read or write, and for User read or write.

Security Extensions implemented, processor in Non-secure state

Only the four current security state VA to PA translation operations are available, as shown in Table B3-33 on page B3-131. These operations provide VA to PA translation for privileged read or write, and for User read or write, in the Non-secure security state.

It is not possible to perform VA to PA translations for the Secure security state. Attempting to access an Other security state VA to PA translation operation encoding generates an Undefined Instruction exception.

Security Extensions implemented, processor in Secure security state

Eight VA to PA Translation operations are available, as shown in Table B3-34 on page B3-131:

- The four current security state VA to PA translation operations provide address translation for privileged read or write, and for User read or write, in the Secure security state.
- The four other security state VA to PA translation operations provide address translation for privileged read or write, and for User read or write, in the Non-secure security state.

Bit [8] IMPLEMENTATION DEFINED.

SH, bit [7]

Shareable attribute. Indicates whether the physical memory is Shareable:

- 0** Memory is Non-shareable
- 1** Memory is Shareable.

Inner[2:0], bits [6:4]

Inner memory attributes ~~from the translation table entry~~. Permitted values are:

- 0b111** Write-Back, no Write-Allocate
- 0b110** Write-Through
- 0b101** Write-Back, Write-Allocate
- 0b011** Device
- 0b001** Strongly-ordered
- 0b000** Non-cacheable.

Other encodings for Inner[2:0] are reserved.

Outer[1:0], bits [3:2]

Outer memory attributes ~~from the translation table~~. Possible values are:

- 0b11** Write-Back, no Write-Allocate.
- 0b10** Write-Through, no Write-Allocate.
- 0b01** Write-Back, Write-Allocate.
- 0b00** Non-cacheable.

SS, bit [1] SuperSection. Used to indicate if the result is a Supersection:

- 0** Page is not a Supersection, that is, PAR[31:12] contains PA[31:12], regardless of the page size.
- 1** Page is part of a Supersection
 - PAR[31:24] contains PA[31:24]
 - PAR[23:16] contains PA[39:32]
 - PAR[15:12] contains 0b0000.

If an implementation supports less than 40 bits of physical address, the bits in the PAR field that correspond to physical address bits that are not implemented are UNKNOWN.

———— **Note** —————

PA[23:12] is the same as VA[23:12] for Supersections

F, bit [0] F bit is 0 if the conversion completed successfully.

In the Inner[2:0] and Outer[1:0] fields, an implementation that does not support all of the attributes can report the memory type behavior that the cache does support, rather than the value held in the translation table entry.

If the translation fails without generating an abort, the format of the PAR is:

31	7 6	1 0
UNK/SBZP	FS	F

Bits [31:7] UNK/SBZP.

FS, bits [6:1] Fault status bits. Bits [12,10,3:0] from the Data Fault Status Register, indicate the source of the abort. For more information, see *c5, Data Fault Status Register (DFSR)* on page B3-121.

F, bit [0] F bit is 1 if the conversion aborted.

The VA to PA translation only generates an abort if the translation fails because an external abort occurred on a translation table walk request. In this case:

- If the external abort is synchronous, the DFSR and DFAR of the security state in which the abort is handled are updated. The DFSR indicates the appropriate external abort on Translation fault, and the DFAR indicates the MVA that caused the translation. PAR is UNKNOWN.
- If the external abort is asynchronous, the DFSR of the security state in which the abort is handled is updated when the abort is taken. The DFSR indicates the asynchronous external abort. The DFAR is not updated. PAR is UNKNOWN.

For all other cases where the VA to PA translation fails:

- No abort is generated, and the DFSR and DFAR are unchanged
- the PAR [6:1] field is updated with an FSR encoding that indicates the fault
- the PAR bit [0] is set to 1.

Implementations that do not support all attributes can report the behavior for those memory types that the cache does support.

Accessing the PAR and the VA to PA translation operations

To access one of the VA to PA translation operations you write the CP15 registers with <opc1> set to 0, <CRn> set to c7, <CRm> set to c8, and <opc2> set to the value shown in Table B3-33 on page B3-131 or Table B3-34 on page B3-131.

With register Rt containing the original VA this gives:

```
MCR p15,0,<Rt>,c7,c8,<opc2>
```

To read the PAR you read the CP15 registers with <opc1> set to 0, <CRn> set to c7, <CRm> set to c4, and <opc2> set to 0. To return the translated PA in register Rt this gives:

```
MRC p15,0,<Rt>,c7,c4,0
```

The PAR is a read/write register, and you can write to the CP15 registers with the same settings to write to the register. There is no translation operation that requires writing to this register, but the write operation might be required to restore the value of the PAR after a context switch.

An example of a VA to PA translation when the Security Extensions are not implemented is:



~~MCR p15,0,<Rt>,c7,c8,2 ; Write CP15 VA to User Read VA to PA Translation Register~~
~~MRC p15,0,<Rt>,c7,c4,0 ; Read CP15 PA from Physical Address Register~~

An example of a VA to PA translation when the Security Extensions are implemented and the processor is in the Secure state is:

~~MCR p15,0,<Rt>,c7,c8,5 ; Write VA to Other State Privileged Write VA to PA Translation Register~~
~~MRC p15,0,<Rt>,c7,c4,0 ; Read PA from Physical Address Register~~
 ~~; Performs VA to PA translation for Non-secure security state~~

VA to PA translation when the MMU is disabled

The VA to PA translation operations occur even when the MMU is disabled. The operations report the flat address mapping and the MMU-disabled value of the attributes and permissions for the data side accesses. These include any MMU-disabled re-mapping specified by the TEX-remap facilities. The SuperSection bit is 0 when the MMU is disabled. For more information about the address and attributes returned when the MMU is disabled see *Enabling and disabling the MMU* on page B3-5.

When the Security Extensions are implemented, this information applies when the MMU is disabled in the security state for which the VA to PA translation is performed.

B3.12.33 CP15 c7, Miscellaneous functions

CP15 c7 provides a number of functions, summarized in Figure B3-10 on page B3-65. This section describes only the CP15 c7 miscellaneous operations.

Figure B3-19 shows the CP15 c7 miscellaneous operations. It does not show the other CP15 c7 operations.

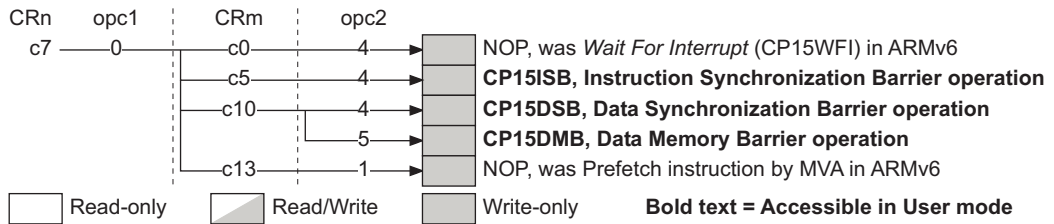

Figure B3-19 CP15 c7 Miscellaneous operations

The CP15 c7 miscellaneous operations are described in:

- *CP15 c7, Data and Instruction Barrier operations* on page B3-137
- *CP15 c7, No Operation (NOP)* on page B3-138.

CP15 c7, Data and Instruction Barrier operations

ARMv6 includes two CP15 c7 operations to perform Data Barrier operations, and another operation to perform an Instruction Barrier operation. In ARMv7:

- The ARM and Thumb instruction sets include instructions to perform the barrier operations, that can be executed in all modes, see *Memory barriers* on page A3-47.
- The CP15 c7 operations are defined as write-only operations, that can be executed in all modes. The three operations are described in:
 - *Instruction Synchronization Barrier operation*
 - *Data Synchronization Barrier operation*
 - *Data Memory Barrier operation.*

The value in the register Rt specified by the MCR instruction used to perform one of these operations is ignored. You do not have to write a value to the register before issuing the MCR instruction.

In ARMv7 using these CP15 c7 operations is deprecated. Use the ISB, DSB, and DMB instructions instead.

Note

- In ARMv6 and earlier documentation, the Instruction Synchronization Barrier operation is referred to as a Prefetch Flush (PFF).
 - In versions of the ARM architecture before ARMv6 the Data Synchronization Barrier operation is described as a *Data Write Barrier* (DWB).
-

Instruction Synchronization Barrier operation

In ARMv7, the ISB instruction is used to perform an Instruction Synchronization Barrier, see *ISB* on page A8-102.

The deprecated CP15 c7 encoding for an Instruction Synchronization Barrier is <opc1> set to 0, <CRn> set to c7, <CRm> set to c5, and <opc2> set to 4.

Data Synchronization Barrier operation

In ARMv7, the DSB instruction is used to perform a Data Synchronization Barrier, see *DSB* on page A8-92.

The deprecated CP15 c7 encoding for a Data Synchronization Barrier is <opc1> set to 0, <CRn> set to c7, <CRm> set to c10, and <opc2> set to 4. This operation performs the full system barrier performed by the DSB instruction.

Data Memory Barrier operation

In ARMv7, the DMB instruction is used to perform a Data Memory Barrier, see *DMB* on page A8-90.

The deprecated CP15 c7 encoding for a Data Memory Barrier is <opc1> set to 0, <CRn> set to c7, <CRm> set to c10, and <opc2> set to 5. This operation performs the full system barrier performed by the DMB instruction.

CP15 c7, No Operation (NOP)

ARMv6 includes two CP15 c7 operations that are not supported in ARMv7, with encodings that become *No Operation* (NOP) in ARMv7. These are:

- The *Wait For Interrupt* (CP15WFI) operation. In ARMv7 this operation is performed by the WFI instruction, that is available in the ARM and Thumb instruction sets. For more information, see *WFI* on page A8-810.
- The prefetch instruction by MVA operation. In ARMv7 this operation is replaced by the PLI instruction, that is available in the ARM and Thumb instruction sets. For more information, see *PLI (immediate, literal)* on page A8-242 and *PLI (register)* on page A8-244.

In ARMv7, the CP15 c7 encodings that were used for these operations must be valid write-only operations that perform a NOP. These encodings are:

- for the ARMv6 CP15WFI operation:
 - <opc1> set to 0, <CRn> set to c7, <CRm> set to c0, and <opc2> set to 4
- for the ARMv6 prefetch instruction by MVA operation:
 - <opc1> set to 0, <CRn> set to c7, <CRm> set to c13, and <opc2> set to 1.

B3.12.34 CP15 c8, TLB maintenance operations

On ARMv7-A implementations, CP15 c8 operations are used for TLB maintenance functions. Figure B3-20 shows the CP15 c8 encodings.

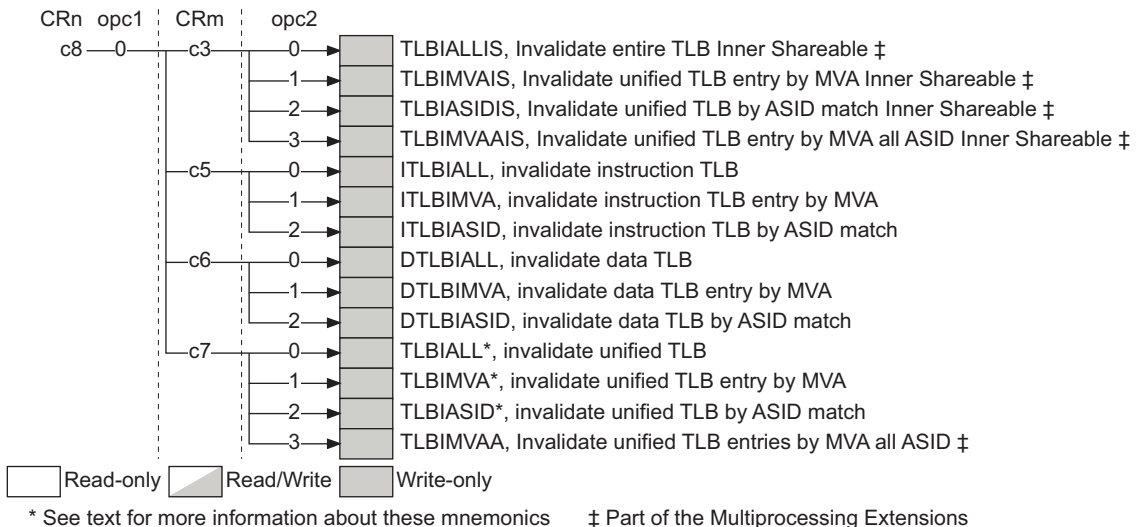

Figure B3-20 CP15 c8 operations

CP15 c8 encodings not shown in Figure B3-20 are UNPREDICTABLE, see *Unallocated CP15 encodings* on page B3-69.

The CP15 c8 TLB maintenance functions:

- are write-only operations
- can be executed only in privileged modes.

Table B3-35 summarizes the TLB maintenance operations.

Table B3-35 CP15 c8 TLB maintenance operations

CRm	opc2	Mnemonic	Function	Rt data
c3	0	TLBIALLIS	Invalidate entire unified TLB ^d Inner Shareable ^a	Ignored
	1	TLBIMVAIS	Invalidate unified TLB ^d entry by MVA Inner Shareable ^a	MVA
	2	TLBIASIDIS	Invalidate unified TLB ^d by ASID match Inner Shareable ^a	ASID
	3	TLBIMVAAIS	Invalidate unified TLB ^d entry by MVA all ASID Inner Shareable ^a	MVA
c5	0	ITLBIALL	Invalidate entire instruction TLB ^b	Ignored
	1	ITLBIMVA	Invalidate instruction TLB ^b entry by MVA	MVA
	2	ITLBIASID	Invalidate instruction TLB ^b by ASID match	ASID
c6	0	DTLBIALL	Invalidate entire data TLB ^b	Ignored
	1	DTLBIMVA	Invalidate data TLB ^b entry by MVA	MVA
	2	DTLBIASID	Invalidate data TLB ^b by ASID match	ASID
c7	0	TLBIALL ^c	Invalidate entire unified TLB ^d	Ignore
	1	TLBIMVA ^c	Invalidate unified TLB ^d entry by MVA	MVA
	2	TLBIASID ^c	Invalidate unified TLB ^d by ASID match	ASID
	3	TLBIMVAA	Invalidate unified TLB ^d entries by MVA all ASID ^a	MVA

a. Implemented only as part of the Multiprocessing Extensions.

b. If these operations are performed on an implementation that has a unified TLB they operate on the unified TLB.

c. The mnemonics for the operations with CRm==c7, opc2=={0,1,2} were previously UTLBIALL, UTLBIMVA and UTLBIMASID.

d. When separate instruction and data TLBs are implemented, these operations are performed on both TLBs.

For more information about the Inner Shareable operations see *Multiprocessor effects on TLB maintenance operations* on page B3-62.

For information about the effect of these operations on locked TLB entries see *The interaction of TLB maintenance operations with TLB lockdown* on page B3-57.

About the TLB maintenance operations

For more information about TLBs and their maintenance see *Translation Lookaside Buffers (TLBs)* on page B3-54, and in particular *TLB maintenance* on page B3-56. The following subsections give more information about the TLB maintenance operations:

- *Invalidate entire TLB*
- *Invalidate single TLB entry by MVA*
- *Invalidate TLB entries by ASID match*
- *Invalidate TLB entries by MVA all ASID* on page B3-141.

As stated in the footnotes to Table B3-35 on page B3-139:

- If an Instruction TLB or Data TLB operation is used on a system that implements a Unified TLB then the operation is performed on the Unified TLB
- If a Unified TLB operation is used on a system that implements separate Instruction and Data TLBs then the operation is performed on both the Instruction TLB and the Data TLB.
- The mnemonics for the operations to invalidate a unified TLB that are defined in the ARM v7 base architecture were previously UTLBIALL, UTLBIMV, and UTLBIASID. These remain synonyms for these operations, but ARM deprecates the use of the older names. These are the operations with CRm==c7, opc2=={0,1,2}.

For information about the synchronization of the TLB maintenance operations see *TLB maintenance operations and the memory order model* on page B3-59.

Invalidate entire TLB

The Invalidate entire TLB operations invalidate all unlocked entries in the TLB. The value in the register Rt specified by the MCR instruction used to perform the operation is ignored. You do not have to write a value to the register before issuing the MCR instruction.

Invalidate single TLB entry by MVA

The Invalidate Single Entry operations invalidate a TLB entry that matches the MVA and ASID values provided as an argument to the operation. The register format required is:

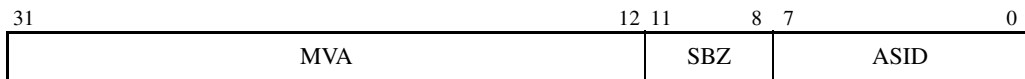

With global entries in the TLB, the supplied ASID value is not checked.

Invalidate TLB entries by ASID match

The Invalidate on ASID Match operations invalidate all TLB entries for non-global pages that match the ASID value provided as an argument to the operation. The register format required is:

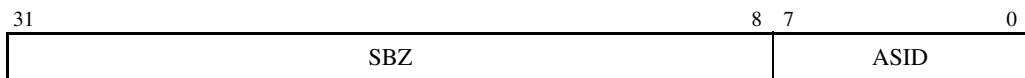

Invalidate TLB entries by MVA all ASID

The Invalidate TLB entries by MVA all ASID operations invalidate all TLB entries that matches the MVA provided as an argument to the operation regardless of the ASID. The register format required is:

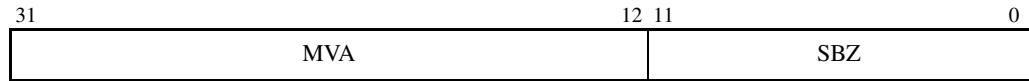
**Accessing the CP15 c8 TLB maintenance operations**

To perform one of the TLB maintenance operations you write the CP15 registers with `<opc1> == 0`, `<CRn>==c8`, and `<CRm>` and `<opc2>` set to the values shown in Table B3-35 on page B3-139. That is:

`MCR p15,0,<Rt>,c8,<CRm>,<opc2>`

For example:

`MCR p15,0,<Rt>,c8,c5,0 ; Invalidate all unlocked entries in Instruction TLB`
`MCR p15,0,<Rt>,c8,c6,2 ; Invalidate Data TLB entries on ASID match`

B3.12.35 CP15 c9, Cache and TCM lockdown registers and performance monitors

Some CP15 c9 encodings are reserved for IMPLEMENTATION DEFINED memory system functions, in particular:

- cache control, including lockdown
- TCM control, including lockdown
- branch predictor control.

Additional CP15 c9 encodings are reserved for performance monitors. These encodings fall into two groups:

- the optional performance monitors, described in Chapter C9 *Performance Monitors*
- additional IMPLEMENTATION DEFINED performance monitors.

The reserved encodings permit implementations that are compatible with previous versions of the ARM architecture, in particular with the ARMv6 requirements. Figure B3-21 shows the permitted CP15 c9 register encodings.

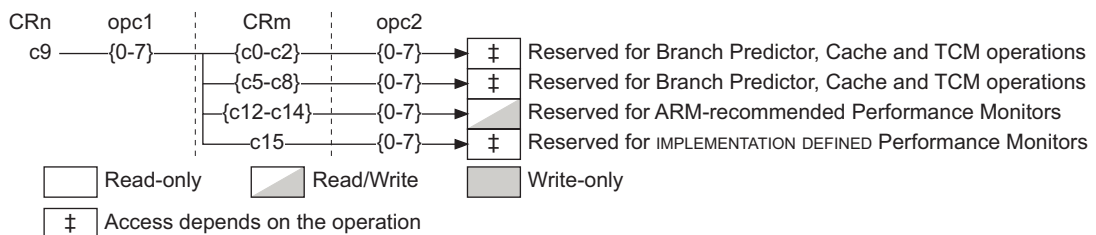

Figure B3-21 Permitted CP15 c9 encodings

CP15 c9 encodings not shown in Figure B3-21 on page B3-141 are UNPREDICTABLE, see *Unallocated CP15 encodings* on page B3-69.

In ARMv6, CP15 c9 provides cache lockdown functions. With the ARMv7 abstraction of the hierarchical memory model, for CP15 c9:

- All encodings with CRm = {c0-c2, c5-c8} are reserved for IMPLEMENTATION DEFINED cache, branch predictor and TCM operations.

This reservation enables the implementation of a scheme that is backwards compatible with ARMv6. For details of the ARMv6 implementation see *c9, Cache lockdown support* on page AppxG-45.

———— **Note** —————

In an ARMv6 implementation that implements the Security Extensions, a Cache Behavior Override Register is required in CP15 c9, with CRm = 8, see *c9, Cache Behavior Override Register (CBOR)* on page AppxG-49. This register is not architecturally-defined in ARMv7, and therefore the CP15 c9 encoding with CRm = 8 is IMPLEMENTATION DEFINED. However, an ARMv7 implementation can include the CBOR, in which case ARM recommends that this encoding is used for it.

- All encodings with CRm = {c12-c14} are reserved for the optional performance monitors that are defined in Chapter C9 *Performance Monitors*.
- All encodings with CRm = c15 are reserved for IMPLEMENTATION DEFINED performance monitoring features.

B3.12.36 CP15 c10, Memory remapping and TLB control registers

On ARMv7-A implementations, CP15 c10 is used for memory remapping registers. In addition, some encodings are reserved for IMPLEMENTATION DEFINED TLB control functions, in particular TLB lockdown. The reserved encodings permit implementations that are compatible with previous versions of the ARM architecture, in particular with the ARMv6 requirements.

Figure B3-22 shows the CP15 c10 registers and reserved encodings.

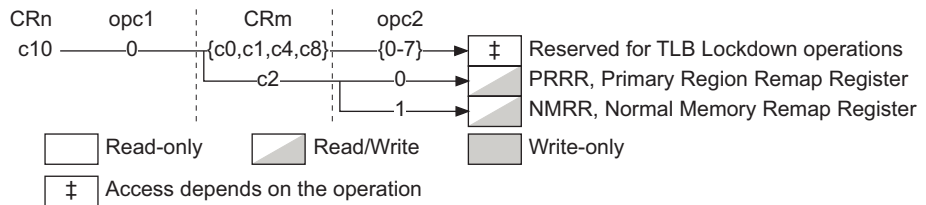

Figure B3-22 CP15 c10 registers

CP15 c10 encodings not shown in Figure B3-22 are UNPREDICTABLE, see *Unallocated CP15 encodings* on page B3-69.

The CP15 c10 memory remap registers are described in *CP15 c10, Memory Remap Registers* on page B3-143.

The IMPLEMENTATION DEFINED TLB control operations

In VMSAv6, CP15 c10 provides TLB lockdown functions. In VMSAv7, the TLB lockdown mechanism is IMPLEMENTATION DEFINED and some CP15 c10 encodings are reserved for IMPLEMENTATION DEFINED TLB control operations. These are the encodings with $\langle CRn \rangle == c10$, $\langle opc1 \rangle == 0$, $\langle CRm \rangle == \{c0, c1, c4, c8\}$, and $\langle opc2 \rangle == \{0-7\}$.

B3.12.37 CP15 c10, Memory Remap Registers

CP15 c10 includes two Memory Remap Registers, described in the subsections:

- *c10, Primary Region Remap Register (PRRR)*
- *c10, Normal Memory Remap Register (NMRR)* on page B3-146.

In addition:

- The significance and use of these registers is described in *Memory region attribute descriptions when TEX remap is enabled* on page B3-34.
- The function of these registers is architecturally defined only when the
 - SCTLR.TRE bit is set to 1
 - SCTLR.TRE bit is set to 0 and no IMPLEMENTATION DEFINED mechanism using MMU remap has been invoked.

Otherwise their behavior is IMPLEMENTATION DEFINED, see *SCTLR.TRE*, *SCTLR.M*, and *the effect of the MMU remap registers* on page B3-38.

c10, Primary Region Remap Register (PRRR)

The Primary Region Remap Register, PRRR, can in some cases control the top level mapping of the TEX[0], C, and B memory region attributes.

The PRRR:

- is a 32-bit read/write register
- is accessible only in privileged modes
- when the Security Extensions are implemented:
 - is a Banked register
 - has write access to the Secure copy of the register disabled when the **CP15SDISABLE** signal is asserted HIGH.

The format of the PRRR is:

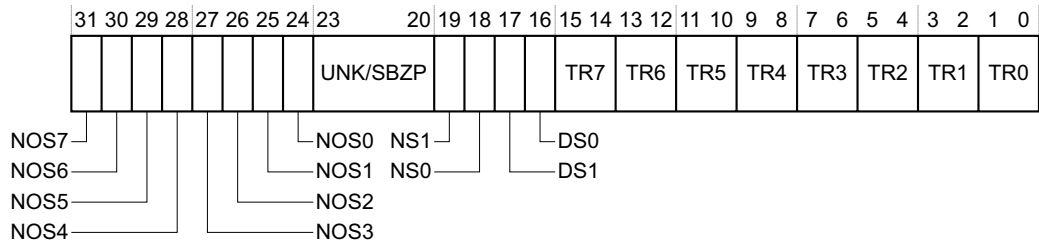

The reset value of the PRRR is IMPLEMENTATION DEFINED.

NOS n , bit [24+ n], for values of n from 0 to 7

Outer Shareable property mapping for memory attributes n , if the region is mapped as Normal Memory that is Shareable. n is the value of the TEX[0], C and B bits, see Table B3-36 on page B3-145. The possible values of each NOS n bit are:

- 0** Shareable Normal memory region is Outer Shareable
- 1** Shareable Normal Memory region is Inner Shareable.

The value of this bit is ignored if the region is not Shareable Normal memory.

The meaning of the field with $n = 6$ is IMPLEMENTATION DEFINED and might differ from the meaning given here. This is because the meaning of the attribute combination {TEX[0] = 1, C = 1, B = 0} is IMPLEMENTATION DEFINED.

If the implementation does not support the Outer Shareable memory attribute then these bits are reserved, RAZ/SBZP.

Bits [23:20] Reserved. UNK/SBZP.

NS1, bit [19] Mapping of S = 1 attribute for Normal memory. This bit gives the mapped Shareable attribute for a region of memory that:

- is mapped as Normal memory
- has the S bit set to 1.

The possible values of the bit are:

- 0** Region is not Shareable
- 1** Region is Shareable.

NS0, bit [18] Mapping of S = 0 attribute for Normal memory. This bit gives the mapped Shareable attribute for a region of memory that:

- is mapped as Normal memory
- has the S bit set to 0.

The possible values of the bit are the same as those given for the NS1 bit, bit [19].

DS1, bit [17] Mapping of S = 1 attribute for Device memory. This bit gives the mapped Shareable attribute for a region of memory that:

- is mapped as Device memory
- has the S bit set to 1.

The possible values of the bit are the same as those given for the NS1 bit, bit [19].

DS0, bit [16] Mapping of S = 0 attribute for Device memory. This bit gives the mapped Shareable attribute for a region of memory that:

- is mapped as Device memory
- has the S bit set to 0.

The possible values of the bit are the same as those given for the NS1 bit, bit [19].

TR n , bits [2 n +1:2 n] for values of n from 0 to 7

Primary TEX mapping for memory attributes n . n is the value of the TEX[0], C and B bits, see Table B3-36. This field defines the mapped memory type for a region with attributes n . The possible values of the field are:

00	Strongly-ordered
01	Device
10	Normal Memory
11	Reserved, effect is UNPREDICTABLE.

The meaning of the field with $n = 6$ is IMPLEMENTATION DEFINED and might differ from the meaning given here. This is because the meaning of the attribute combination {TEX[0] = 1, C = 1, B = 0} is IMPLEMENTATION DEFINED.

Table B3-36 shows the mapping between the memory region attributes and the n value used in the PRRR.nOS n and PRRR.TR n field descriptions.

Table B3-36 Memory attributes and the n value for the PRRR field descriptions

Attributes			n value
TEX[0]	C	B	
0	0	0	0
0	0	1	1
0	1	0	2
0	1	1	3
1	0	0	4
1	0	1	5

Table B3-36 Memory attributes and the n value for the PRRR field descriptions (continued)

Attributes			n value
TEX[0]	C	B	
1	1	0	6
1	1	1	7

For more information about the PRRR see *Memory region attribute descriptions when TEX remap is enabled* on page B3-34.

Accessing the PRRR

To access the PRRR you read or write the CP15 registers with <opc1> set to 0, <CRn> set to c10, <CRm> set to c2, and <opc2> set to 0. For example:

```
MRC p15,0,<Rt>,c10,c2,0 ; Read CP15 Primary Region Remap Register
MCR p15,0,<Rt>,c10,c2,0 ; Write CP15 Primary Region Remap Register
```

c10, Normal Memory Remap Register (NMRR)

The Normal Memory Remap Register, NMRR, can in some cases provide additional mapping controls for memory regions that are mapped as Normal memory by their entry in the PRRR.

The NMRR:

- is a 32-bit read/write register
- is accessible only in privileged modes
- when the Security Extensions are implemented:
 - is a Banked register
 - has write access to the Secure copy of the register disabled when the **CP15SDISABLE** signal is asserted HIGH.

The format of the NMRR is:

31	30	29	28	27	26	25	24	23	22	21	20	19	18	17	16	15	14	13	12	11	10	9	8	7	6	5	4	3	2	1	0
OR7	OR6	OR5	OR4	OR3	OR2	OR1	OR0	IR7	IR6	IR5	IR4	IR3	IR2	IR1	IR0																

The reset value of the NMRR is IMPLEMENTATION DEFINED.

OR n , bits [2 n +17:2 n +16], for values of n from 0 to 7

Outer Cacheable property mapping for memory attributes n , if the region is mapped as Normal Memory by the TR n entry in the PRRR, see *c10, Primary Region Remap Register (PRRR)* on page B3-143. n is the value of the TEX[0], C and B bits, see Table B3-36 on page B3-145. The possible values of this field are:

- 00** Region is Non-cacheable
- 01** Region is Write-Back, WriteAllocate

B3.12.39 CP15 c12, Security Extensions registers

When the Security Extensions are implemented, CP15 c12 is used for the Vector base address registers and an Interrupt status register. Figure B3-24 shows the CP15 c12 Security Extensions registers:

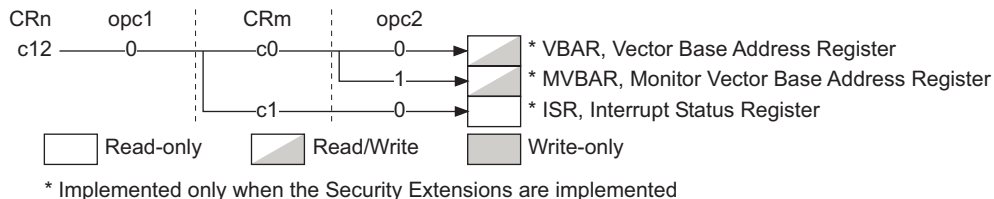

Figure B3-24 Security Extensions CP15 c12 registers

When the Security Extensions are implemented, CP15 c12 encodings not shown in Figure B3-24 are UNPREDICTABLE. On an implementation that does not include the Security Extensions all CP15 c12 encodings are UNDEFINED. For more information, see *Unallocated CP15 encodings* on page B3-69.

The CP15 c12 registers are described in the subsections:

- *c12, Vector Base Address Register (VBAR)*
- *c12, Monitor Vector Base Address Register (MVBAR)* on page B3-149
- *c12, Interrupt Status Register (ISR)* on page B3-150.

B3.12.40 c12, Vector Base Address Register (VBAR)

When the Security Extensions are implemented and high exception vectors are not selected, the Vector Base Address Register, VBAR, provides the exception base address for exceptions that are not handled in Monitor mode, see *Exception vectors and the exception base address* on page B1-30. The high exception vectors always have the base address `0xFFFF0000` and are not affected by the value of VBAR.

The VBAR:

- Is present only when the Security Extensions are implemented.
- Is a 32-bit read/write register.
- Is accessible only in privileged modes.
- Has a defined reset value, for the Secure copy of the register, of 0. This reset value does not apply to the Non-secure copy of the register, and software must program the Non-secure copy of the register with the required value, as part of the processor boot sequence.
- Is a Banked register.
- Has write access to the Secure copy of the register disabled when the **CP15SDISABLE** signal is asserted HIGH.

The format of the VBAR is:

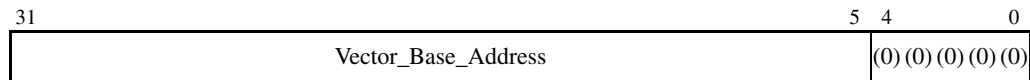

The Secure copy of the VBAR holds the vector base address for the Secure state, described as the Secure exception base address

The Non-secure copy of the VBAR holds the vector base address for the Non-secure state, described as the Non-secure exception base address.

Vector_Base_Address, bits [31:5]

Bits [31:5] of the base address of the normal exception vectors. Bits [4:0] of an exception vector is the exception offset, see Table B1-3 on page B1-31.

Bits [4:0] Reserved, UNK/SBZP.

For details of how the VBAR registers are used to determine the exception addresses see *Exception vectors and the exception base address* on page B1-30.

Accessing the VBAR

To access the VBAR you read or write the CP15 registers with <opc1> set to 0, <CRn> set to c12, <CRm> set to c0, and <opc2> set to 0. For example:

```
MRC p15,0,<Rt>,c12,c0,0 ; Read CP15 Vector Base Address Register
MCR p15,0,<Rt>,c12,c0,0 ; Write CP15 Vector Base Address Register
```

B3.12.41 c12, Monitor Vector Base Address Register (MVBAR)

The Monitor Vector Base Address Register, MVBAR, provides the exception base address for all exceptions that are handled in Monitor mode, see *Exception vectors and the exception base address* on page B1-30.

The MVBAR is:

- present only when the Security Extensions are implemented
- a 32-bit read/write register
- accessible in Secure privileged modes only
- a Restricted access register, meaning it exists only in the Secure state.

The format of the MVBAR is:

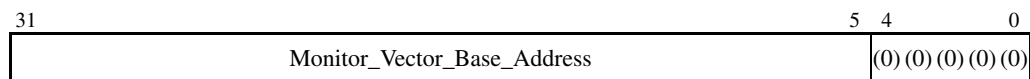

The reset value of the MVBAR is UNKNOWN. The MVBAR must be programmed as part of the boot sequence.

Monitor_Vector_Base_Address, bits [31:5]

Bits [31:5] of the base address of the exception vectors for exceptions that are handled in Monitor mode. Bits [4:0] of an exception vector is the exception offset, see Table B1-3 on page B1-31.

Bits [4:0] Reserved, UNK/SBZP.

For details of how the MVBAR is used to determine the exception addresses see *Exception vectors and the exception base address* on page B1-30.

Accessing the MVBAR

To access the MVBAR you read or write the CP15 registers with <opc1> set to 0, <CRn> set to c12, <CRm> set to c0, and <opc2> set to 1. For example:

```
MRC p15,0,<Rt>,c12,c0,1 ; Read CP15 Monitor Vector Base Address Register
MCR p15,0,<Rt>,c12,c0,1 ; Write CP15 Monitor Vector Base Address Register
```

B3.12.42 c12, Interrupt Status Register (ISR)

The Interrupt Status Register, ISR, shows whether an IRQ, FIQ or external abort is pending.

The ISR is:

- present only when the Security Extensions are implemented
- a 32-bit read-only register
- accessible only in privileged modes.
- a Common register, meaning it is available in the Secure and Non-secure states.

The format of the ISR is:

31	9	8	7	6	5	0							
UNK					A	I	F	(0)	(0)	(0)	(0)	(0)	(0)

Bits [31:9] Reserved, UNK.

A, bit [8] External abort pending flag:

0	no pending external abort
1	an external abort is pending.

I, bit [7] Interrupt pending flag. Indicates whether an IRQ interrupt is pending:

0	no pending IRQ
1	an IRQ interrupt is pending.

F, bit [7] Fast interrupt pending flag. Indicates whether an FIQ fast interrupt is pending:

0	no pending FIQ
1	an FIQ fast interrupt is pending.

Bits [5:0] Reserved, UNK/SBZP.

The bit positions of the A, I and F flags in the ISR match the A, I and F flag bits in the CPSR, see *Program Status Registers (PSRs)* on page B1-14. This means the same masks can be used to extract the flags from the register value.

Note

- The ISR.F and ISR.I bits directly reflect the state of the FIQ and IRQ inputs.
 - the ISR.A bit is set when an asynchronous abort is generated and is cleared automatically when the abort is taken.
-

Accessing the ISR

To access the ISR you read the CP15 registers with <opc1> set to 0, <CRn> set to c12, <CRm> set to c1, and <opc2> set to 0. For example:

```
MRC p15,0,<Rt>,c12,c1,0 ; Read Interrupt Status Register
```

B3.12.43 CP15 c13, Process, context and thread ID registers

The CP15 c13 registers are used for:

- a Context ID register
- three software Thread ID registers
- an FCSE Process ID Register.

Note

From ARMv6, use of the FCSE is deprecated, and in ARMv7 the FCSE is an optional component of a VMSA implementation. ARM expects the FCSE will become obsolete during the lifetime of ARMv7. However, every ARMv7-A implementation must include the FCSE Process ID Register.

Figure B3-25 on page B3-152 shows the CP15 c13 registers:

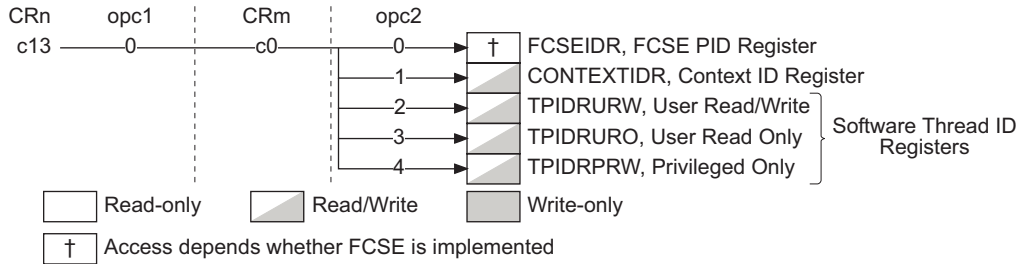

Figure B3-25 CP15 c13 registers in a VMSA implementation

CP15 c13 encodings not shown in Figure B3-25 are UNPREDICTABLE, see *Unallocated CP15 encodings* on page B3-69.

The CP15 c13 registers are described in:

- *c13*, FCSE Process ID Register (FCSEIDR)
- *c13*, Context ID Register (CONTEXTIDR) on page B3-153
- CP15 c13 Software Thread ID registers on page B3-154.

B3.12.44 c13, FCSE Process ID Register (FCSEIDR)

The FCSE Process ID Register, FCSEIDR, identifies the current *Process ID* (PID) for the *Fast Context Switch Extension* (FCSE). In ARMv7, the FCSE is optional. However, the FCSEIDR must be implemented regardless of whether the FCSE is implemented. Software can access this register to determine whether the FCSE is implemented.

The FCSEIDR:

- Is a 32-bit register, with access that depends on whether the FCSE is implemented:
 - FCSE implemented:** . the register is read/write
 - FCSE not implemented:** . the register is RAZ/WI.
- Is accessible only in privileged modes.
- When implemented as a read/write register, has a defined reset value of 0. When the Security Extensions are implemented, this reset value applies only to the Secure copy of the register, and software must program the Non-secure copy of the register with the required value.
- When the Security Extensions are implemented, is a Banked register.

When the Security Extensions are implemented and the FCSE is implemented, write access to the Secure copy of the FCSEIDR is disabled when the **CP15SDISABLE** signal is asserted HIGH.

The format of the FCSEIDR is:

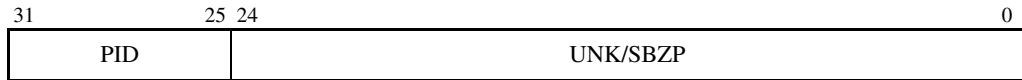

PID, bits [31:25]

The current Process ID, for the FCSE. If the FCSE is not implemented this field is RAZ/WI.

Bits [24:0] Reserved. If the FCSE is not implemented this field is RAZ/WI.

If the FCSE is implemented, the value of this field is UNKNOWN on reads and Should-Be-Zero-or-Preserved on writes.

Note

- When the PID is written, the overall virtual-to-physical address mapping changes. Because of this, you must ensure that instructions that might have been prefetched already are not affected by the address mapping change.
- From ARMv6, use of the FCSE is deprecated, and in ARMv7 the FCSE is optional.

Accessing the FCSEIDR

To access the FCSEIDR you read or write the CP15 registers with <opc1> set to 0, <CRn> set to c13, <CRm> set to c0, and <opc2> set to 0. For example:

```
MRC p15,0,<Rt>,c13,c0,0 ; Read CP15 FCSE PID Register
MCR p15,0,<Rt>,c13,c0,0 ; Write CP15 FCSE PID Register
```

B3.12.45 c13, Context ID Register (CONTEXTIDR)

The Context ID Register, CONTEXTIDR, identifies the current:

- *Process Identifier* (PROCID)
- *Address Space Identifier* (ASID).

The value of the whole of this register is called the *Context ID* and is used by:

- the debug logic, for Linked and Unlinked Context ID matching, see *Breakpoint debug events* on page C3-5 and *Watchpoint debug events* on page C3-15.
- the trace logic, to identify the current process.

The ASID field value is used by many memory management functions.

The CONTEXTIDR is:

- a 32-bit read/write register
- accessible only in privileged modes
- when the Security Extensions are implemented, a Banked register.

The format of the CONTEXTIDR is:

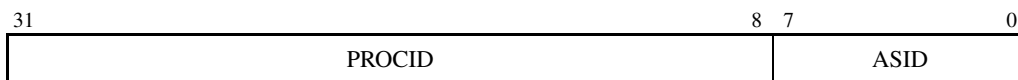

PROCID, bits [31:8]

Process Identifier. This field must be programmed with a unique value that identifies the current process. It is used by the trace logic and the debug logic to identify the process that is running currently.

ASID, bits [7:0]

Address Space Identifier. This field is programmed with the value of the current ASID.

Using the CONTEXTIDR

For information about the synchronization of changes to the CONTEXTIDR see *Changes to CP15 registers and the memory order model* on page B3-77. There are particular synchronization requirements when changing the ASID and Translation Table Base Registers, see *Synchronization of changes of ASID and TTBR* on page B3-60.

Accessing the CONTEXTIDR

To access the CONTEXTIDR you read or write the CP15 registers with <opc1> set to 0, <CRn> set to c13, <CRm> set to c0, and <opc2> set to 1. For example:

```
MRC p15,0,<Rt>,c13,c0,1 ; Read CP15 Context ID Register
MCR p15,0,<Rt>,c13,c0,1 ; Write CP15 Context ID Register
```

B3.12.46 CP15 c13 Software Thread ID registers

The Software Thread ID registers provide locations where software can store thread identifying information, for OS management purposes. These registers are never updated by the hardware.

The Software Thread ID registers are:

- three 32-bit register read/write registers:
 - User Read/Write Thread ID Register, TPIDRURW
 - User Read-only Thread ID Register, TPIDRURO
 - Privileged Only Thread ID Register, TPIDRPRW.
- accessible in different modes:
 - the User Read/Write Thread ID Register is read/write in unprivileged and privileged modes
 - the User Read-only Thread ID Register is read-only in User mode, and read/write in privileged modes
 - the Privileged Only Thread ID Register is only accessible in privileged modes, and is read/write.
- when the Security Extensions are implemented, Banked registers
- introduced in ARMv7.

Accessing the Software Thread ID registers

To access the Software Thread ID registers you read or write the CP15 registers with <opc1> set to 0, <CRn> set to c13, <CRm> set to c0, and <opc2> set to:

- 2 for the User Read/Write Thread ID Register, TPIDRURW
- 3 for the User Read-only Thread ID Register, TPIDRURO
- 4 for the Privileged Only Thread ID Register, TPIDRPRW.

For example:

```
MRC p15, 0, <Rt>, c13, c0, 2 ; Read CP15 User Read/Write Thread ID Register
MCR p15, 0, <Rt>, c13, c0, 2 ; Write CP15 User Read/Write Thread ID Register
MRC p15, 0, <Rt>, c13, c0, 3 ; Read CP15 User Read-only Thread ID Register
MCR p15, 0, <Rt>, c13, c0, 3 ; Write CP15 User Read-only Thread ID Register
MRC p15, 0, <Rt>, c13, c0, 4 ; Read CP15 Privileged Only Thread ID Register
MCR p15, 0, <Rt>, c13, c0, 4 ; Write CP15 Privileged Only Thread ID Register
```

B3.12.47 CP15 c14, Not used

CP15 c14 is not used on any ARMv7 implementation, see *Unallocated CP15 encodings* on page B3-69.

B3.12.48 CP15 c15, IMPLEMENTATION DEFINED registers

CP15 c15 is reserved for IMPLEMENTATION DEFINED purposes. ARMv7 does not impose any restrictions on the use of the CP15 c15 encodings. The documentation of the ARMv7 implementation must describe fully any registers implemented in CP15 c15. Normally, for processor implementations by ARM, this information is included in the *Technical Reference Manual* for the processor.

Typically, CP15 c15 is used to provide test features, and any required configuration options that are not covered by this manual.

B3.13 Pseudocode details of VMSA memory system operations

This section contains pseudocode describing VMSA memory operations. The following subsections describe the pseudocode functions:

- *Alignment fault*
- *FCSE translation*
- *Address translation* on page B3-157
- *Domain checking* on page B3-157
- *TLB operations* on page B3-158
- *Translation table walk* on page B3-158.

See also the pseudocode for general memory system operations in *Pseudocode details of general memory system operations* on page B2-29.

B3.13.1 Alignment fault

The following pseudocode describes the generation of an Alignment fault Data Abort exception:

```
// AlignmentFaultV()
// =====

AlignmentFaultV(bits(32) address, boolean iswrite)

    mva = FCSETranslate(address);
    DataAbort(mva, bits(4) UNKNOWN, boolean UNKNOWN, iswrite, DAbort_Alignment);
```

B3.13.2 FCSE translation

The following pseudocode describes the FCSE translation:

```
// FCSETranslate()
// =====

bits(32) FCSETranslate(bits(32) va)
    if va<31:25> == '0000000' then
        mva = FCSEIDR.PID : va<24:0>;
    else
        mva = va;
    return mva;
```

B3.13.3 Address translation

The following pseudocode describes address translation in a VMSA implementation:

```
// TranslateAddressV()
// =====

AddressDescriptor TranslateAddressV(bits(32) va, boolean ispriv, boolean iswrite)

    mva = FCSETranslate(va);

    if SCTL.R.M == '1' then // MMU is enabled
        (tlbhit, tlbrecord) = CheckTLB(CONTEXTIDR.ASID, mva);
        if !tlbhit then
            tlbrecord = TranslationTableWalk(mva, iswrite);
        if CheckDomain(tlbrecord.domain, mva, tlbrecord.sectionnotpage, iswrite) then
            CheckPermission(tlbrecord.perms, mva, tlbrecord.sectionnotpage, iswrite, ispriv);
    else
        tlbrecord = TranslationTableWalk(mva, iswrite);

    return tlbrecord.addrdesc;
```

B3.13.4 Domain checking

The following pseudocode describes domain checking:

```
// CheckDomain()
// =====

boolean CheckDomain(bits(4) domain, bits(32) mva, boolean sectionnotpage, boolean iswrite)

    bitpos = 2*UInt(domain);
    case DACR<bitpos+1:bitpos> of
        when '00' DataAbort(mva, domain, sectionnotpage, iswrite, DAbort_Domain);
        when '01' permissioncheck = TRUE;
        when '10' UNPREDICTABLE;
        when '11' permissioncheck = FALSE;

    return permissioncheck;
```

B3.13.5 TLB operations

The TLBRecord type represents the contents of a TLB entry:

```
// Types of TLB entry

enumeration TLBRecType = { TLBRecType_SmallPage,
                           TLBRecType_LargePage,
                           TLBRecType_Section,
                           TLBRecType_Supersection,
                           TLBRecType_MMUDisabled
                           };

type TLBRecord is (
    Permissions    perms,
    bit            nG,           // '0' = Global, '1' = not Global
    bits(4)       domain,
    boolean        sectionnotpage,
    TLBRecType    type,
    AddressDescriptor addrdesc
)

```

The CheckTLB() function checks whether the TLB contains an entry that matches an ASID and address, and returns TRUE and the matching TLBRecord if so. Otherwise, it returns FALSE and an UNKNOWN TLBRecord.

```
(boolean, TLBRecord) CheckTLB(bits(8) asid, bits(32) address)
```

The AssignToTLB() procedure supplies an ASID and new TLBRecord to the TLB, for possible allocation to a TLB entry. It is IMPLEMENTATION DEFINED under what circumstances this allocation takes place, and TLB entries might also be allocated at other times.

```
AssignToTLB(bits(8) asid, bits(32) mva, TLBRecord entry)
```

B3.13.6 Translation table walk

The following pseudocode describes the translation table walk operation:

```
// TranslationTableWalk()
// =====
//
// Returns a result of a translation table walk in TLBRecord form.

TLBRecord TranslationTableWalk(bits(32) mva, boolean is_write)

    TLBRecord    result;
    AddressDescriptor l1descaddr;
    AddressDescriptor l2descaddr;

    if SCTL.R.M == '1' then // MMU is enabled

        domain = bits(4) UNKNOWN; // For Data Abort exceptions found before a domain is known

        // Determine correct Translation Table Base Register to use.
        n = UInt(TTBCR.N);

```



```

if n == 0 || IsZero(mva<31:(32-n)>) then
    ttbr = TTBR0;
    disabled = (TTBCR.PD0 == '1');
else
    ttbr = TTBR1;
    disabled = (TTBCR.PD1 == '1');
    n = 0; // TTBR1 translation always works like N=0 TTBR0 translation

// Check this Translation Table Base Register is not disabled.
if HaveSecurityExt() && disabled == '1' then
    DataAbort(mva, domain, TRUE, is_write, DAbort_Translation);

// Obtain level 1 descriptor.
l1descaddr.paddress.physicaladdress = ttbr<31:(14-n)> : mva<(31-n):20> : '00';
l1descaddr.paddress.physicaladdressext = '00000000';
l1descaddr.paddress.NS = if IsSecure() then '0' else '1';
l1descaddr.memattrs.type = MemType_Normal;
l1descaddr.memattrs.shareable = (ttbr<1> == '1');
l1descaddr.memattrs.outershareable = (ttbr<5> == '0') && (ttbr<1> == '1');
l1descaddr.memattrs.outerattrs = ttbr<4:3>;

if HaveMPEExt() then
    l1descaddr.memattrs.innerattrs = ttbr<0>:ttbr<6>;
else
    if ttbr<0> == '0' then
        l1descaddr.memattrs.innerattrs = '00';
    else
        IMPLEMENTATION_DEFINED set l1descaddr.memattrs.innerattrs to one of
        '01', '10', '11';
    l1desc = _Mem[l1descaddr,4];

// Process level 1 descriptor.
case l1desc<1:0> of
    when '00', '11' // Fault, Reserved
        DataAbort(mva, domain, TRUE, is_write, DAbort_Translation);

    when '01' // Section or Supersection
        texcb = l1desc<14:12,3,2>;
        S = l1desc<16>;
        ap = l1desc<15,11:10>;
        xn = l1desc<4>;
        nG = l1desc<17>;
        sectionnotpage = TRUE;
        NS = l1desc<19>;

        if SCTL.AFE == '1' && l1desc<10> == '0' then
            if SCTL.HA == '0' then
                DataAbort(mva, domain, sectionnotpage, is_write, DAbort_AccessFlag);
            else // Hardware-managed access flag must be set in memory
                _Mem[l1descaddr,4]<10> = '1';

        if l1desc<18> == '0' then // Section
            domain = l1desc<8:5>;
            type = TLBRecType_Section;

```

```

        physicaladdresst = '00000000';
        physicaladdress = l1desc<31:20> : mva<19:0>;
    else // Supersection
        domain = '0000';
        type = TLBRecType_Supersection;
        physicaladdresst = l1desc<8:5,23:20>;
        physicaladdress = l1desc<31:24> : mva<23:0>;

when '10' // Large page or Small page
    domain = l1desc<8:5>;
    sectionnotpage = FALSE;
    NS = l1desc<3>;

    // Obtain level 2 descriptor.
    l2descaddr.paddress.physicaladdress = l1desc<31:10> : mva<19:12> : '00';
    l2descaddr.paddress.physicaladdresst = '00000000';
    l2descaddr.paddress.NS = if IsSecure() then '0' else '1';
    l2descaddr.memattr = l1descaddr.memattr;
    l2desc = _Mem[l2descaddr,4];

    // Process level 2 descriptor.
    if l2desc<1:0> == '00' then
        DataAbort(mva, domain, sectionnotpage, is_write, DAbort_Translation);

    S = l2desc<10>;
    ap = l2desc<9,5:4>;
    nG = l2desc<11>;

    if SCTLRAFE == '1' && l2desc<4> == '0' then
        if SCTLRAHA == '0' then
            DataAbort(mva, domain, sectionnotpage, is_write, DAbort_AccessFlag);
        else // Hardware-managed access flag must be set in memory
            _Mem[l2descaddr,4]<4> = '1';

    if l2desc<1> == '0' then // Large page
        texcb = l2desc<14:12,3,2>;
        xn = l2desc<15>;
        type = TLBRecType_LargePage;
        physicaladdresst = '00000000';
        physicaladdress = l2desc<31:16> : mva<15:0>;
    else // Small page
        texcb = l2desc<8:6,3,2>;
        xn = l2desc<0>;
        type = TLBRecType_SmallPage;
        physicaladdresst = '00000000';
        physicaladdress = l2desc<31:12> : mva<11:0>;

else // MMU is disabled

    texcb = '00000';
    S = '1';
    ap = bits(3) UNKNOWN;
    xn = bit UNKNOWN;
    nG = bit UNKNOWN;

```

```

    domain = bits(4) UNKNOWN;
    sectionnotpage = boolean UNKNOWN;
    type = TLBRecType_MMUDisabled;
    physicaladdress = mva;
    physicaladressext = '00000000';
    NS = if IsSecure() then '0' else '1';

// Decode the TEX, C, B and S bits to produce the TLBRecord's memory attributes.

if SCTL.R.TRE == '0' then
    if RemapRegsHaveResetValues() then
        result.addrdesc.memattrs = DefaultTEXDecode(texcb, S);
    else
        IMPLEMENTATION_DEFINED setting of result.addrdesc.memattrs;
else
    if SCTL.R.M == '0' then
        result.addrdesc.memattrs = DefaultTEXDecode(texcb, S);
    else
        result.addrdesc.memattrs = RemappedTEXDecode(texcb, S);

// Set the rest of the TLBRecord, try to add it to the TLB, and return it.
result.perms.ap = ap;
result.perms.xn = xn;
result.nG = nG;
result.domain = domain;
result.sectionnotpage = sectionnotpage;
result.type = type;
result.addrdesc.paddress.physicaladdress = physicaladdress;
result.addrdesc.paddress.physicaladressext = physicaladressext;
result.addrdesc.paddress.NS = NS;

AssignToTLB(CONTEXTIDR.ASID, mva, result);

return result;

```

Chapter B4

Protected Memory System Architecture (PMSA)

This chapter provides a system-level view of the memory system. It contains the following sections:

- *About the PMSA* on page B4-2
- *Memory access control* on page B4-9
- *Memory region attributes* on page B4-11
- *PMSA memory aborts* on page B4-13
- *Fault Status and Fault Address registers in a PMSA implementation* on page B4-18
- *CPI5 registers for a PMSA implementation* on page B4-22
- *Pseudocode details of PMSA memory system operations* on page B4-79.

Note

For an ARMv7-R implementation, this chapter must be read with Chapter B2 *Common Memory System Architecture Features*.

B4.1 About the PMSA

The PMSA is based on a *Memory Protection Unit* (MPU). The PMSA provides a much simpler memory protection scheme than the MMU based VMSA described in Chapter B3 *Virtual Memory System Architecture* (VMSA). The simplification applies to both the hardware and the software. A PMSAv7 processor is identified by the presence of the MPU Type Register, see *c0, MPU Type Register (MPUIR)* on page B4-36.

The main simplification is that the MPU does not use translation tables. Instead, System Control Coprocessor (CP15) registers are used to define *protection regions*. The protection regions eliminate the need for:

- hardware to perform translation table walks
- software to set up and maintain the translation tables.

The use of protection regions has the benefit of making the memory checking fully deterministic. However, the level of control is region based rather than page based, meaning the control is considerably less fine-grained than in the VMSA.

A second simplification is that the PMSA does not support virtual to physical address mapping other than flat address mapping. The physical memory address accessed is the same as the virtual address generated by the processor.

B4.1.1 Protection regions

In a PMSA implementation, you can use CP15 registers to define protection regions in the physical memory map. When describing a PMSA implementation, protection regions are often referred to as regions.

This means the PMSA has the following features:

- For each defined region, CP15 registers specify:
 - the region size
 - the base address
 - the memory attributes, for example, memory type and access permissions.

Regions of 256 bytes or larger can be split into 8 sub-regions for improved granularity of memory access control.

The minimum region size supported is IMPLEMENTATION DEFINED.

- Memory region control, requiring read and write access to the region configuration registers, is possible only from privileged modes.
- Regions can overlap. If an address is defined in multiple regions, a fixed priority scheme is used to define the properties of the address being accessed. This scheme gives priority to the region with the highest region number.
- The PMSA can be configured so that an access to an address that is not defined in any region either:
 - causes a memory abort
 - if it is a privileged access, uses the default memory map.

- All addresses are physical addresses, address translation is not supported.
- Instruction and data address spaces can be either:
 - unified, so a single region descriptor applies to both instruction and data accesses
 - separated between different instruction region descriptors and data region descriptors.

When the processor generates a memory access, the MPU compares the memory address with the programmed memory regions:

- If a matching memory region is not found, then:
 - the access can be mapped onto a background region, see *Using the default memory map as a background region* on page B4-5
 - otherwise, a Background Fault memory abort is signaled to the processor.
- If a matching memory region is found:
 - The access permission bits are used to determine whether the access is permitted. If the access is not permitted, the MPU signals a Permissions Fault memory abort. Otherwise, the access proceeds. See *Memory access control* on page B4-9 for a description of the access permission bits.
 - The memory region attributes are used to determine the memory type, as described in *Memory region attributes* on page B4-11.

B4.1.2 Subregions

A region of the PMSA memory map can be split into eight equal sized, non-overlapping subregions:

- any region size between 256bytes and 4Gbytes supports 8 sub-regions
- region sizes below 256 bytes do not support sub-regions

In the Region Size Register for each region, there is a Subregion disable bit for each subregion. This means that each subregion is either:

- part of the region, if its Subregion disable bit is 0
- not part of the region, if its Subregion disable bit is 1.

If the region size is smaller than 256 bytes then all eight of the Subregion bits are ~~UNK/SBZ~~.

If a subregion is part of the region then the protection and memory type attributes of the region apply to the subregion. If a subregion is not part of the region then the addresses covered by the subregion do not match as part of the region.

Subregions are not available in versions of the PMSA before PMSAv7.

B4.1.3 Overlapping regions

The MPU can be programmed with two or more overlapping regions. When memory regions overlap, a fixed priority scheme determines the region whose attributes are applied to the memory access. The higher the region number the higher the priority. Therefore, for example, in an implementation that supports eight memory regions, the attributes for region 7 have highest priority and those for region 0 have lowest priority.

Figure B4-1 shows a case where the MPU is programmed with overlapping memory regions.

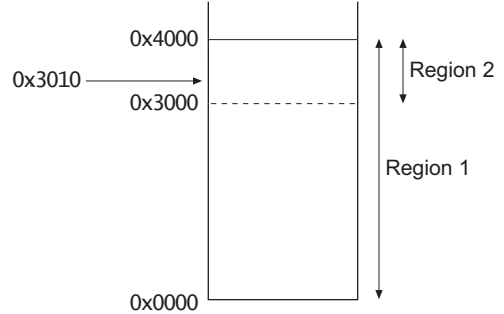

Figure B4-1 Overlapping memory regions in the MPU

In this example:

- Data region 2 is programmed to be 4KB in size, starting from address `0x3000` with `AP[2:0] == 0b010`, giving privileged mode full access, User mode read-only access.
- Data region 1 is programmed to be 16KB in size, starting from address `0x0` with `AP[2:0] == 0b001`, giving privileged mode access only.

If the processor performs a data load from address `0x3010` while in User mode, the address is in both region 1 and region 2. Region 2 has the higher priority, therefore the region 2 attributes apply to the access. This means the load does not abort.

B4.1.4 The background region

Background region refers to a region that matches the entire 4GB physical address map, and has a lower priority than any other region. Therefore, a background region provides the memory attributes for any memory access that does not match any of the defined memory regions.

When the `SCTLR.BR` bit is set to 0, the MPU behaves as if there is a background region that generates a Background Fault memory abort on any access. This means that any memory access that does not match any of the programmed memory regions generates a Background Fault memory abort. This is the same as the behavior in PMSAv6.

If you want a background region with a different set of memory attributes, you can program region 0 as a 4GB region with the attributes you require. Because region 0 has the lowest priority this region then acts as a background region.

Using the default memory map as a background region

The default memory map is defined in *The default memory map* on page B4-6. Before PMSAv7, the default memory map is used only to define the behavior of memory accesses when the MPU is disabled or not implemented. From PMSAv7, when the SCTL.R.BR bit is set to 1, and the MPU is present and enabled:

- the default memory map defines the background region for privileged memory accesses, meaning that a privileged access that does not match any of the programmed memory regions takes the properties defined for that address in the default memory map
- an unprivileged memory access that does not match any of the defined memory regions generates a Background Fault memory abort.

Using the default memory map as the background region means that all of the programmable memory region definitions can be used to define protection regions in the 4GB memory address space.

B4.1.5 Enabling and disabling the MPU

The SCTL.R.M bit is used to enable and disable the MPU, see *c1, System Control Register (SCTL.R)* on page B4-45. On reset, this bit is cleared to 0, meaning the MPU is disabled after a reset.

Software must program all relevant CP15 registers before enabling the MPU. This includes at least one of:

- setting up at least one memory region
- setting the SCTL.R.BR bit to 1, to use the default memory map as a background region, see *Using the default memory map as a background region*.

Synchronization of changes to the CP15 registers is discussed in *Changes to CP15 registers and the memory order model* on page B4-28. These considerations apply to any change that enables or disables the MPU or the caches.

Behavior when the MPU is disabled

When the MPU is disabled:

- Instruction accesses use the default memory map and attributes shown in Table B4-1 on page B4-6. An access to a memory region with the Execute Never attribute generates a Permission fault, see *The Execute Never (XN) attribute and instruction prefetching* on page B4-10. No other permission checks are performed. Additional control of the cacheability is made by:
 - the SCTL.R.I bit if separate instruction and data caches are implemented
 - the SCTL.R.C bit if unified caches are implemented.
- Data accesses use the default memory map and attributes shown in Table B4-2 on page B4-7. No memory access permission checks are performed, and no aborts can be generated.
- Program flow prediction functions as normal, controlled by the value of the SCTL.R.Z bit, see *c1, System Control Register (SCTL.R)* on page B4-45.
- All of the CP15 cache operations work as normal.

- Instruction and data prefetch operations work as normal, based on the default memory map:
 - Data prefetch operations have no effect if the data cache is disabled
 - Instruction prefetch operations have no effect if the instruction cache is disabled.
- The Outer memory attributes are the same as those for the Inner memory system.

The default memory map

The PMSAv7 default memory map is fixed and not configurable, and is shown in:

- Table B4-1 for the instruction access attributes
- Table B4-2 on page B4-7 for the data access attributes.

The regions of the default memory map are identical in both tables. The information about the memory map is split into two tables only to improve the presentation of the information.

Table B4-1 Default memory map, showing instruction access attributes

Address range	HIVECS	Instruction memory type		Execute Never, XN
		Caching enabled ^a	Caching disabled ^a	
0xFFFFFFFF - 0xF0000000	0	Not applicable	Not applicable	Execute Never
0xFFFFFFFF - 0xF0000000	1 ^b	Normal, Non-cacheable	Normal, Non-cacheable	Execution permitted
0xEFFFFFFF - 0xC0000000	X	Not applicable	Not applicable	Execute Never
0xBFFFFFFF - 0xA0000000	X	Not applicable	Not applicable	Execute Never
0x9FFFFFFF - 0x80000000	X	Not applicable	Not applicable	Execute Never
0x7FFFFFFF - 0x60000000	X	Normal, Non-shareable, Write-Through Cacheable	Normal, Non-shareable, Non-cacheable	Execution permitted
0x5FFFFFFF - 0x40000000	X	Normal, Non-shareable, Write-Through Cacheable	Normal, Non-shareable, Non-cacheable	Execution permitted
0x3FFFFFFF - 0x00000000	X	Normal, Non-shareable, Write-Through Cacheable	Normal, Non-shareable, Non-cacheable	Execution permitted

- When separate instruction and data caches are implemented, caching is enabled for instruction accesses if the instruction caches are enabled. When unified caches are implemented caching is enabled if the data or unified caches are enabled. See the descriptions of the C and I bits in *c1*, *System Control Register (SCTLR)* on page B4-45.
- Use of HIVECS == 1 is deprecated in PMSAv7, see *Exception vectors and the exception base address* on page B1-30.

Table B4-2 Default memory map, showing data access attributes

Address range	Data memory type	
	Caching enabled ^a	Caching disabled
0xFFFFFFFF - 0xC0000000	Strongly-ordered	Strongly-ordered
0xBFFFFFFF - 0xA0000000	Shareable Device	Shareable Device
0x9FFFFFFF - 0x80000000	Non-shareable Device	Non-shareable Device
0x7FFFFFFF - 0x60000000	Normal, Shareable, Non-cacheable	Normal, Shareable, Non-cacheable
0x5FFFFFFF - 0x40000000	Normal, Non-shareable, Write-Through Cacheable	Normal, Shareable, Non-cacheable
0x3FFFFFFF - 0x00000000	Normal, Non-shareable, Write-Back, Write-Allocate Cacheable	Normal, Shareable, Non-cacheable

- a. Caching is enabled for data accesses if the data or unified caches are enabled. See the description of the C bit in *c1*, *System Control Register (SCTLR)* on page B4-45.

Behavior of an implementation that does not include an MPU

If a PMSAv7 implementation does not include an MPU, it must adopt the default memory map behavior described in *Behavior when the MPU is disabled* on page B4-5.

A PMSAv7 implementation that does not include an MPU is identified by an MPU Type Register entry that shows a Unified MPU with zero Data or Unified regions, see *c0*, *MPU Type Register (MPUIR)* on page B4-36.

B4.1.6 Finding the minimum supported region size

You can use the DRBAR to find the minimum region size supported by an implementation, by following this procedure:

1. Write a valid memory region number to the RGNR. Normally you use region number 0, because this is always a valid region number.
2. Write the value 0xFFFFFFFF to the DRBAR. This value sets all valid bits in the register to 1.
3. Read back the value of the DRBAR. In the returned value the least significant bit set indicates the resolution of the selected region. If the least significant bit set is bit *M* the resolution of the region is 2^M bytes.

If the MPU implements separate data and instruction regions this process gives the minimum size for data regions. To find the minimum size for instruction regions, use the same procedure with the IRBAR.

For more information about the registers used see:

- *c6, MPU Region Number Register (RGNR)* on page B4-66
- *c6, Data Region Base Address Register (DRBAR)* on page B4-60
- *c6, Instruction Region Base Address Register (IRBAR)* on page B4-61.

B4.2 Memory access control

Access to a memory region is controlled by the access permission bits for each region, held in the DRACR and IRACR. For descriptions of the registers see:

- *c6*, *Data Region Access Control Register (DRACR)* on page B4-64
- *c6*, *Instruction Region Access Control Register (IRACR)* on page B4-65.

B4.2.1 Access permissions

Access permission bits control access to the corresponding memory region. If an access is made to an area of memory without the required permissions, a Permission fault is generated. In the appropriate Region Access Control Register:

- the AP bits determine the access permissions
- the XN bit provides an additional permission bit for instruction fetches.

The access permissions are a three-bit field, DRACR.AP[2:0] or IRACR.AP[2:0]. Table B4-3 shows the possible values of this field.

Table B4-3 Access permissions

AP[2:0]	Privileged permissions	User permissions	Description
000	No access	No access	All accesses generate a Permission fault
001	Read/Write	No access	All User mode accesses generate Permission faults
010	Read/Write	Read-only	User mode write accesses generate Permission faults
011	Read/Write	Read/Write	Full access
100	UNPREDICTABLE	UNPREDICTABLE	Reserved
101	Read-only	No Access	Privileged read-only, all other accesses generate Permission faults
110	Read-only	Read-only	All write accesses generate Permission faults.
111	UNPREDICTABLE	UNPREDICTABLE	Reserved

The Execute Never (XN) attribute and instruction prefetching

Each memory region can be tagged as not containing executable code. If the *Execute never* (XN) bit is set to 1, any attempt to execute an instruction in that region results in a Permission fault, and the implementation must not access the region to prefetch instructions speculatively. If the XN bit is 0, code can execute from that memory region.

———— **Note** —————

The XN bit acts as an additional permission check. The address must also have a valid read access permission.

In ARMv7, all regions of memory that contain read-sensitive peripherals must be marked as XN to avoid the possibility of a speculative prefetch accessing the locations.

B4.3 Memory region attributes

Each memory region has an associated set of memory region attributes. These control accesses to the caches, how the write buffer is used, and whether the memory region is Shareable and therefore is guaranteed by hardware to be coherent. These attributes are encoded in the C, B, TEX[2:0] and S bits of the appropriate Region Access Control Register.

———— Note —————

The *Bufferable* (B), *Cacheable* (C), and *Type Extension* (TEX) bit names are inherited from earlier versions of the architecture. These names no longer adequately describe the function of the B, C, and TEX bits.

B4.3.1 C, B, and TEX[2:0] encodings

The TEX[2:0] field must be considered with the C and B bits to give a five bit encoding of the access attributes for an MPU memory region. Table B4-4 shows these encodings.

For Normal memory regions, the S (Shareable) bit gives more information about whether the region is Shareable. A Shareable region can be shared by multiple processors. A Normal memory region is Shareable if the S bit for the region is set to 1. For other memory types, the value of the S bit is ignored.

Table B4-4 C, B and TEX[2:0] encodings

TEX[2:0]	C	B	Description	Memory type	Shareable?
000	0	0	Strongly-ordered.	Strongly-ordered	Shareable
000	0	1	Shareable Device.	Device	Shareable
000	1	0	Outer and Inner Write-Through, no Write-Allocate.	Normal	S bit ^a
000	1	1	Outer and Inner Write-Back, no Write-Allocate.	Normal	S bit ^a
001	0	0	Outer and Inner Non-cacheable.	Normal	S bit ^a
001	0	1	Reserved.	-	-
001	1	0	IMPLEMENTATION DEFINED.	IMP. DEF. ^b	IMP. DEF. ^b
001	1	1	Outer and Inner Write-Back, Write-Allocate.	Normal	S bit ^a
010	0	0	Non-shareable Device.	Device	Non-shareable
010	0	1	Reserved.	-	-
010	1	X	Reserved.	-	-

Table B4-4 C, B and TEX[2:0] encodings (continued)

TEX[2:0]	C	B	Description	Memory type	Shareable?
011	X	X	Reserved.	-	-
1BB	A	A	Cacheable memory: AA = Inner attribute ^c BB = Outer policy	Normal	S bit ^a

- a. Region is Shareable if S == 1, and Non-shareable if S == 0.
- b. IMP. DEF. = IMPLEMENTATION DEFINED.
- c. For more information see *Cacheable memory attributes*.

For an explanation of Normal, Strongly-ordered and Device memory types, and the Shareable attribute, see *Memory types and attributes and the memory order model* on page A3-24.

Cacheable memory attributes

When TEX[2] == 1, the memory region is Cacheable memory, and the rest of the encoding defines the Inner and Outer cache attributes:

TEX[1:0] defines the Outer cache attribute
C,B defines the Inner cache attribute

The same encoding is used for the Outer and Inner cache attributes. Table B4-5 shows the encoding.

Table B4-5 Inner and Outer cache attribute encoding

Memory attribute encoding	Cache attribute
00	Non-cacheable
01	Write-Back, Write-Allocate
10	Write-Through, no Write-Allocate
11	Write-Back, no Write-Allocate

B4.4 PMSA memory aborts

The mechanisms that cause the ARM processor to take an exception because of a memory access are:

- | | |
|-----------------------|---|
| MPU fault | The MPU detects an access restriction and signals the processor. |
| External abort | A memory system component other than the MPU signals an illegal or faulting external memory access. |

The exception taken is a Prefetch Abort exception if either of these occurs synchronously on an instruction fetch, and a Data Abort exception otherwise.

Collectively these mechanisms are called *aborts*. The different abort mechanisms are described in:

- *MPU faults*
- *External aborts* on page B4-15.

An access that causes an abort is said to be *aborted*, and uses the *Fault Address Registers (FARs)* and *Fault Status Registers (FSRs)* to record context information. The FARs and FSRs are described in *Fault Status and Fault Address registers in a PMSA implementation* on page B4-18.

Also, a debug exception can cause the processor to take a Prefetch Abort exception or a Data Abort exception, and to update the FARs and FSRs. For details see Chapter C4 *Debug Exceptions and Debug event prioritization* on page C3-43.

B4.4.1 MPU faults

The MPU checks the memory accesses required for instruction fetches and for explicit memory accesses:

- if an instruction fetch faults it generates a Prefetch Abort exception
- if an explicit memory access faults it generates a Data Abort exception.

For more information about Prefetch Abort exceptions and Data Abort exceptions see *Exceptions* on page B1-30.

MPU faults are always synchronous. For more information, see *Terminology for describing exceptions* on page B1-4.

When the MPU generates an abort for a region of memory, no memory access is made if that region is or could be marked as Strongly-ordered or Device.

The MPU can generate three types of fault, described in the subsections:

- *Alignment fault* on page B4-14
- *Background fault* on page B4-14
- *Permission fault* on page B4-14.

The MPU fault checking sequence on page B4-15 describes the fault checking sequence.

Alignment fault

The ARMv7 memory architecture requires support for strict alignment checking. This checking is controlled by the SCTLRA bit, see *c1, System Control Register (SCTLR)* on page B4-45. For details of when Alignment faults are generated see *Unaligned data access* on page A3-5.

Background fault

If the memory access address does not match one of the programmed MPU memory regions, and the default memory map is not being used, a Background Fault memory abort is generated.

Background faults cannot occur on any cache or branch predictor maintenance operation.

Permission fault

The access permissions, defined in *Memory access control* on page B4-9, are checked against the processor memory access. If the access is not permitted, a Permission Fault memory abort is generated.

Permission faults cannot occur on cache or branch predictor maintenance operation.

The MPU fault checking sequence

Figure B4-2 shows the MPU fault checking sequence, when the MPU is enabled.

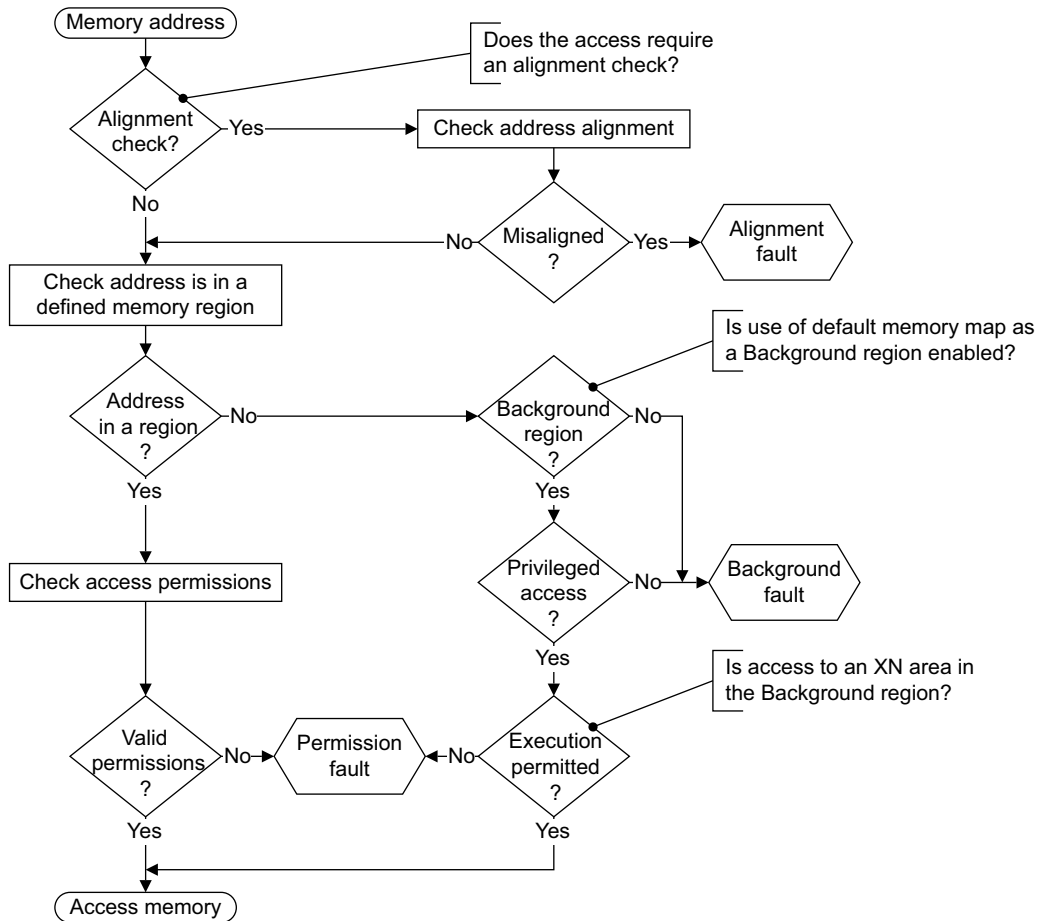

Figure B4-2 MPU fault checking sequence

B4.4.2 External aborts

External memory errors are defined as errors that occur in the memory system other than those that are detected by the MPU or Debug hardware. They include parity errors detected by the caches or other parts of the memory system. An external abort is one of:

- synchronous
- precise asynchronous
- imprecise asynchronous.

For more information, see *Terminology for describing exceptions* on page B1-4.

The ARM architecture does not provide a method to distinguish between precise asynchronous and imprecise asynchronous aborts.

The ARM architecture handles asynchronous aborts in a similar way to interrupts, except that they are reported to the processor using the Data Abort exception. Setting the CPSR.A bit to 1 masks asynchronous aborts, see *Program Status Registers (PSRs)* on page B1-14.

Normally, external aborts are rare. An imprecise asynchronous external abort is likely to be fatal to the process that is running. An example of an event that might cause an external abort is an uncorrectable parity or ECC failure on a Level 2 memory structure.

It is IMPLEMENTATION DEFINED which external aborts, if any, are supported.

PMSAv7 permits external aborts on data accesses and instruction fetches to be either synchronous or asynchronous. The DFSR indicates whether the external abort is synchronous or asynchronous, see *c5, Data Fault Status Register (DFSR)* on page B4-55.

———— **Note** —————

Because imprecise external aborts are normally fatal to the process that caused them, ARM recommends that implementations make external aborts precise wherever possible.

More information about possible external aborts is given in the subsections:

- *External abort on instruction fetch*
- *External abort on data read or write*
- *Parity error reporting* on page B4-17.

For information about how external aborts are reported see *Fault Status and Fault Address registers in a PMSA implementation* on page B4-18.

External abort on instruction fetch

An external abort on an instruction fetch can be either synchronous or asynchronous. A synchronous external abort on an instruction fetch is taken precisely.

An implementation can report the external abort asynchronously from the instruction that it applies to. In such an implementation these aborts behave essentially as interrupts. They are masked by the CPSR.A bit when it is set to 1, otherwise they are reported using the Data Abort exception.

External abort on data read or write

Externally generated errors during a data read or write can be either synchronous or asynchronous.

An implementation can report the external abort asynchronously from the instruction that generated the access. In such an implementation these aborts behave essentially as interrupts. They are masked by the CPSR.A bit when it is set to 1, otherwise they are reported using the Data Abort exception.

Parity error reporting

The ARM architecture supports the reporting of both synchronous and asynchronous parity errors from the cache systems. It is IMPLEMENTATION DEFINED what parity errors in the cache systems, if any, result in synchronous or asynchronous parity errors.

A fault status code is defined for reporting parity errors, see *Fault Status and Fault Address registers in a PMSA implementation* on page B4-18. However when parity error reporting is implemented it is IMPLEMENTATION DEFINED whether the assigned fault status code or another appropriate encoding is used to report parity errors.

For all purposes other than the fault status encoding, parity errors are treated as external aborts.

B4.4.3 Prioritization of aborts

For synchronous aborts, *Debug event prioritization* on page C3-43 describes the relationship between debug events, MPU faults and external aborts.

In general, the ARM architecture does not define when asynchronous events are taken, and therefore the prioritization of asynchronous events is IMPLEMENTATION DEFINED.

———— **Note** —————

A special requirement applies to asynchronous watchpoints, see *Debug event prioritization* on page C3-43.

B4.5 Fault Status and Fault Address registers in a PMSA implementation

This section describes the Fault Status and Fault Address registers, and how they report information about PMSA aborts. It contains the following subsections:

- *About the Fault Status and Fault Address registers*
- *Data Abort exceptions* on page B4-19
- *Prefetch Abort exceptions* on page B4-19
- *Fault Status Register encodings for the PMSA* on page B4-19
- *Distinguishing read and write accesses on Data Abort exceptions* on page B4-21
- *Provision for classification of external aborts* on page B4-21
- *Auxiliary Fault Status Registers* on page B4-21.

Also, these registers are used to report information about debug exceptions. For details see *Effects of debug exceptions on CP15 registers and the DBGWFAR* on page C4-4.

B4.5.1 About the Fault Status and Fault Address registers

PMSAv7 provides four registers for reporting fault address and status information:

- The *Data Fault Status Register*, see c5, *Data Fault Status Register (DFSR)* on page B4-55. The DFSR is updated on taking a Data Abort exception.
- The *Instruction Fault Status Register*, see c5, *Instruction Fault Status Register (IFSR)* on page B4-56. The IFSR is updated on taking a Prefetch Abort exception.
- The *Data Fault Address Register*, see c6, *Data Fault Address Register (DFAR)* on page B4-57. In some cases, on taking a synchronous Data Abort exception the DFAR is updated with the faulting address. See *Terminology for describing exceptions* on page B1-4 for a description of synchronous exceptions.
- The *Instruction Fault Address Register*, see c6, *Instruction Fault Address Register (IFAR)* on page B4-58. The IFAR is updated with the faulting address on taking a Prefetch Abort exception.

In addition, the architecture provides encodings for two IMPLEMENTATION DEFINED Auxiliary Fault Status Registers, see *Auxiliary Fault Status Registers* on page B4-21.

Note

- ~~On a Data Abort exception that is generated by an instruction cache maintenance operation, the IFSR is also updated.~~
- Before ARMv7, the *Data Fault Address Register (DFAR)* was called the *Fault Address Register (FAR)*.



On a Watchpoint debug exception, the *Watchpoint Fault Address Register (DBGWFAR)* is used to hold fault information. On a watchpoint access the DBGWFAR is updated with the address of the instruction that generated the Data Abort exception. For more information, see *Watchpoint Fault Address Register (DBGWFAR)* on page C10-28.

B4.5.2 Data Abort exceptions

On taking a Data Abort exception the processor:

- updates the DFSR with a fault status code
- if the Data Abort exception is synchronous:
 - updates the DFSR with whether the faulted access was a read or a write
 - if the Data Abort exception was not caused by a Watchpoint debug event, updates the DFAR with the address that caused the Data Abort exception
 - if the Data Abort exception was caused by a Watchpoint debug event, the DFAR becomes UNKNOWN
- if the Data Abort exception is asynchronous, the DFAR becomes UNKNOWN.

On an access that might have multiple aborts, the MPU fault checking sequence and the prioritization of aborts determine which abort occurs. For more information, see *The MPU fault checking sequence* on page B4-15 and *Prioritization of aborts* on page B4-17.

B4.5.3 Prefetch Abort exceptions

A Prefetch Abort exception can be generated on an instruction fetch. The Prefetch Abort exception is taken synchronously with the instruction that the abort is reported on. This means:

- If the instruction is executed a Prefetch Abort exception is generated.
- If the instruction fetch is issued but the processor does not attempt to execute the instruction no Prefetch Abort exception is generated. For example, if the processor branches round the instruction no Prefetch Abort exception is generated.

On taking a Prefetch Abort exception the processor:

- updates the IFSR with a fault status code
- updates the IFAR with the address that caused the Prefetch Abort exception.

B4.5.4 Fault Status Register encodings for the PMSA

For the PMSA fault status encodings in priority order see:

- Table B4-6 for the Instruction Fault Status Register (IFSR) encodings
- Table B4-7 on page B4-20 for the Data Fault Status Register (DFSR) encodings.

Table B4-6 PMSAv7 IFSR encodings

IFSR [10,3:0] ^a	Sources	IFAR	Notes
00001	Alignment fault	Valid	MPU fault
00000	Background fault	Valid	MPU fault
01101	Permission fault	Valid	MPU fault

Table B4-6 PMSAv7 IFSR encodings (continued)

IFSR [10,3:0] ^a	Sources	IFAR	Notes
00010	Debug event	UNKNOWN	See <i>Software debug events</i> on page C3-5
01000	Synchronous external abort	Valid	-
10100	IMPLEMENTATION DEFINED	-	Lockdown
11010	IMPLEMENTATION DEFINED	-	Coprocessor abort
11001	Memory access synchronous parity error	Valid	-

a. All IFSR[10,3:0] values not listed in this table are reserved.

Table B4-7 PMSAv7 DFSR encodings

DFSR [10,3:0] ^a	Sources	DFAR	Notes
00001	Alignment fault	Valid	MPU fault
00000	Background fault	Valid	MPU fault
01101	Permission fault	Valid	MPU fault
00010	Debug event	UNKNOWN	See <i>Software debug events</i> on page C3-5
01000	Synchronous external abort	Valid	-
10100	IMPLEMENTATION DEFINED	-	Lockdown
11010	IMPLEMENTATION DEFINED	-	Coprocessor abort
11001	Memory access synchronous parity error	^b	-
10110	Asynchronous external abort	UNKNOWN	-
11000	Memory access asynchronous parity error	UNKNOWN	-

a. All DFSR[10,3:0] values not listed in this table are reserved.

b. It is IMPLEMENTATION DEFINED whether the DFAR is updated for a synchronous parity error.

Note

In previous ARM documentation, the terms precise and imprecise were used instead of synchronous and asynchronous. For details of the more exact terminology introduced in this manual see *Terminology for describing exceptions* on page B1-4.

Reserved encodings in the IFSR and DFSR encodings tables

A single encoding is reserved for cache lockdown faults. The details of these faults and any associated subsidiary registers are IMPLEMENTATION DEFINED.

A single encoding is reserved for aborts associated with coprocessors. The details of these faults are IMPLEMENTATION DEFINED.

B4.5.5 Distinguishing read and write accesses on Data Abort exceptions

On a Data Abort exception, the DFSR.WnR bit, bit [11] of the register, indicates whether the abort occurred on a read access or on a write access. However, for a fault on a CP15 cache maintenance operation this bit always indicates a write access fault.

For a fault generated by a SWP or SWPB instruction, the WnR bit is 0 if a read to the location would have generated a fault, otherwise it is 1.

B4.5.6 Provision for classification of external aborts

An implementation can use the DFSR.ExT and IFSR.ExT bits to provide more information about external aborts:

- DFSR.ExT can provide an IMPLEMENTATION DEFINED classification of external aborts on data accesses
- IFSR.ExT can provide an IMPLEMENTATION DEFINED classification of external aborts on instruction accesses

For all aborts other than external aborts these bits return a value of 0.

B4.5.7 Auxiliary Fault Status Registers

ARMv7 architects two Auxiliary Fault Status Registers:

- the Auxiliary Data Fault Status Register (ADFSR)
- the Auxiliary Instruction Fault Status Register (AIFSR).

These registers enable additional fault status information to be returned:

- The position of these registers is architecturally-defined, but the content and use of the registers is IMPLEMENTATION DEFINED.
- An implementation that does not need to report additional fault information must implement these registers as UNK/SBZ. This ensures that a privileged attempt to access these registers is not faulted.

An example use of these registers would be to return more information for diagnosing parity errors.

See *c5, Auxiliary Data and Instruction Fault Status Registers (ADFSR and AIFSR)* on page B4-56 for the architectural details of these registers.

B4.6 CP15 registers for a PMSA implementation

This section gives a full description of the registers implemented in the CP15 System Control Coprocessor in an ARMv7 implementation that includes the PMSA memory system. Therefore, this is the description of the CP15 registers for an ARMv7-R implementation.

Some of the registers described in this section are also included in an ARMv7 implementation with a VMSA. The section *CP15 registers for a VMSA implementation* on page B3-64 also includes descriptions of these registers.

See *Coprocessors and system control* on page B1-62 for general information about the System Control Coprocessor, CP15 and the register access instructions MRC and MCR.

Information in this section is organized as follows:

- general information is given in:
 - *Organization of the CP15 registers in a PMSA implementation*
 - *General behavior of CP15 registers* on page B4-26
 - *Changes to CP15 registers and the memory order model* on page B4-28
 - *Meaning of fixed bit values in register diagrams* on page B4-29.
- this is followed by, for each of the primary CP15 registers c0 to c15:
 - a general description of the organization of the primary CP15 register
 - detailed descriptions of all the registers in that primary register.

————— Note —————

The detailed descriptions of the registers that implement the processor identification scheme, CPUID, are given in Chapter B5 *The CPUID Identification Scheme*, and not in this section.

Table B4-8 on page B4-24 lists all of the CP15 registers in a PMSA implementation, and is an index to the detailed description of each register.

B4.6.1 Organization of the CP15 registers in a PMSA implementation

Figure B4-3 on page B4-23 summarizes the ARMv7 CP15 registers when the PMSA is implemented. Table B4-8 on page B4-24 lists all of these registers.

————— Note —————

ARMv7 introduces significant changes to the memory system registers, especially in relation to caches. For details of:

- the CP15 register implementation in PMSAv6, see *Organization of CP15 registers for an ARMv6 PMSA implementation* on page AppxG-31.
- how the ARMv7 registers must be used to discover what caches can be accessed by the processor, see *Identifying the cache resources in ARMv7* on page B2-4.

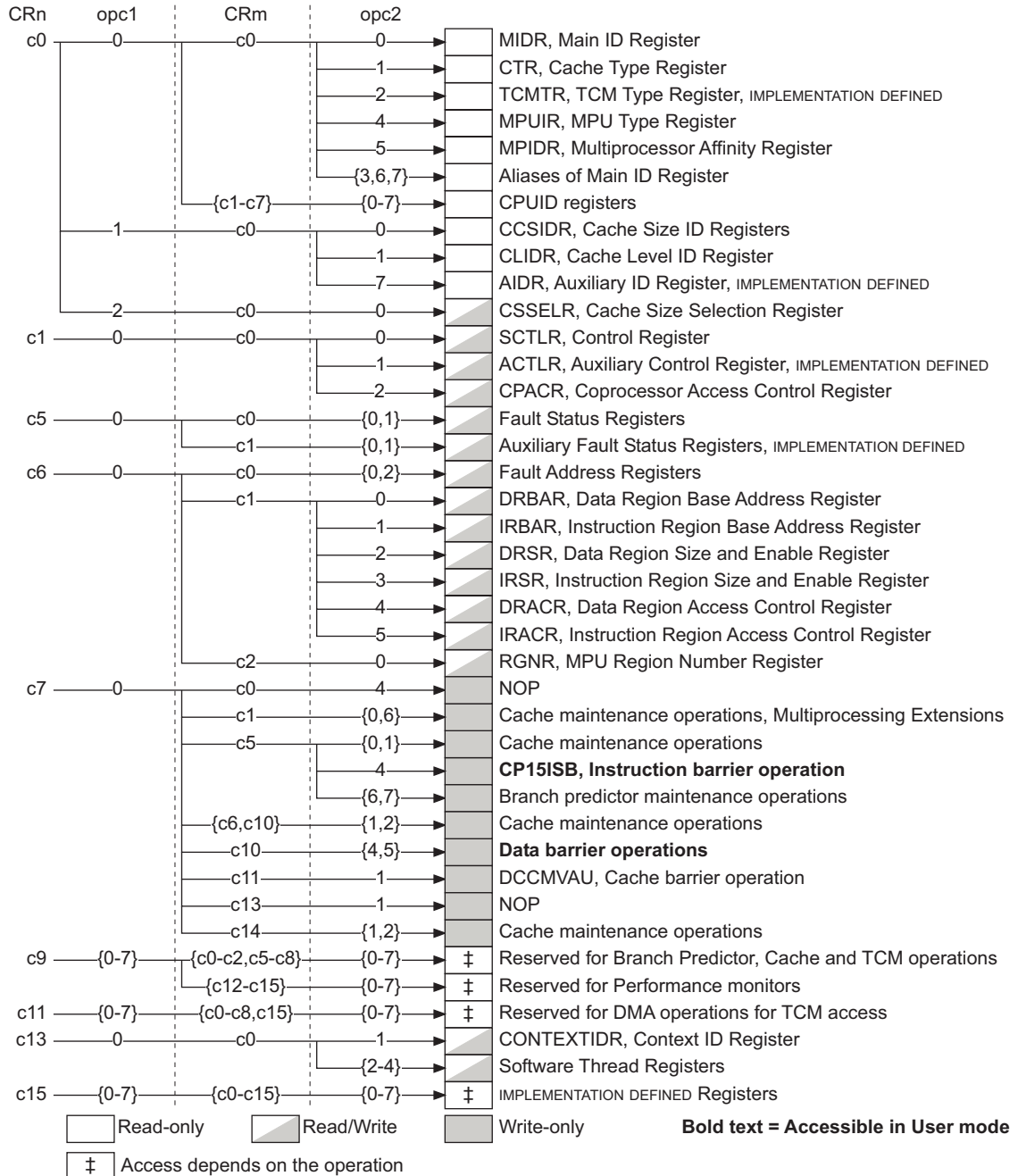

Figure B4-3 CP15 registers in a PMSA implementation

For information about the CP15 encodings not shown in Figure B4-3 on page B4-23 see *Unpredictable and undefined behavior for CP15 accesses* on page B4-26.

Summary of CP15 register descriptions in a PMSA implementation

Table B4-8 shows the CP15 registers in a PMSA implementation. The table also includes links to the descriptions of each of the primary CP15 registers, c0 to c15.

Table B4-8 Summary of CP15 registers in a PMSA implementation

Register and description
<i>CP15 c0, ID codes registers</i> on page B4-30
<i>c0, Main ID Register (MIDR)</i> on page B4-32
<i>c0, Cache Type Register (CTR)</i> on page B4-34
<i>c0, TCM Type Register (TCMTR)</i> on page B4-35
<i>c0, MPU Type Register (MPUIR)</i> on page B4-36
<i>c0, Multiprocessor Affinity Register (MPIDR)</i> on page B4-37
<i>CP15 c0, Processor Feature registers</i> on page B5-4
<i>c0, Debug Feature Register 0 (ID_DFR0)</i> on page B5-6
<i>c0, Auxiliary Feature Register 0 (ID_AFR0)</i> on page B5-8
<i>CP15 c0, Memory Model Feature registers</i> on page B5-9
<i>CP15 c0, Instruction Set Attribute registers</i> on page B5-19
<i>c0, Cache Size ID Registers (CCSIDR)</i> on page B4-40
<i>c0, Cache Level ID Register (CLIDR)</i> on page B4-41
<i>c0, Implementation defined Auxiliary ID Register (AIDR)</i> on page B4-43
<i>c0, Cache Size Selection Register (CSSELR)</i> on page B4-43
<i>CP15 c1, System control registers</i> on page B4-44
<i>c1, System Control Register (SCTLR)</i> on page B4-45
<i>c1, Implementation defined Auxiliary Control Register (ACTLR)</i> on page B4-50
<i>c1, Coprocessor Access Control Register (CPACR)</i> on page B4-51
CP15 registers c2, c3, and c4 are not used on a PMSA implementation, see <i>Unallocated CP15 encodings</i> on page B4-27

Table B4-8 Summary of CP15 registers in a PMSA implementation (continued)

Register and description
<i>CP15 c5 and c6, Memory system fault registers on page B4-53</i>
<i>c5, Data Fault Status Register (DFSR) on page B4-55</i>
<i>c5, Instruction Fault Status Register (IFSR) on page B4-56</i>
<i>c5, Auxiliary Data and Instruction Fault Status Registers (ADFSR and AIFSR) on page B4-56</i>
<i>c6, Data Fault Address Register (DFAR) on page B4-57</i>
<i>c6, Instruction Fault Address Register (IFAR) on page B4-58</i>
<i>c6, Data Region Base Address Register (DRBAR) on page B4-60</i>
<i>c6, Instruction Region Base Address Register (IRBAR) on page B4-61</i>
<i>c6, Data Region Size and Enable Register (DRSR) on page B4-62</i>
<i>c6, Instruction Region Size and Enable Register (IRSR) on page B4-63</i>
<i>c6, Data Region Access Control Register (DRACR) on page B4-64</i>
<i>c6, Instruction Region Access Control Register (IRACR) on page B4-65</i>
<i>c6, MPU Region Number Register (RGNR) on page B4-66</i>
<i>CP15 c7, Cache maintenance and other functions on page B4-68</i>
<i>CP15 c7, Cache and branch predictor maintenance functions on page B4-68</i>
<i>CP15 c7, Data and Instruction Barrier operations on page B4-72</i>
<i>CP15 c7, No Operation (NOP) on page B4-73</i>
<i>CP15 c8 is not used on a PMSA implementation, see <i>Unallocated CP15 encodings</i> on page B4-27</i>
<i>CP15 c9, Cache and TCM lockdown registers and performance monitors on page B4-74</i>
<i>CP15 c10 is not used on a PMSA implementation, see <i>Unallocated CP15 encodings</i> on page B4-27</i>
<i>CP15 c11, Reserved for TCM DMA registers on page B4-75</i>
<i>CP15 c12 is not used on a PMSA implementation, see <i>Unallocated CP15 encodings</i> on page B4-27</i>

Table B4-8 Summary of CP15 registers in a PMSA implementation (continued)

Register and description
<i>CP15 c13, Context and Thread ID registers on page B4-75</i>
<i>c13, Context ID Register (CONTEXTIDR) on page B4-76</i>
<i>CP15 c13 Software Thread ID registers on page B4-77</i>
<i>CP15 c14 is not used on a PMSA implementation, see <i>Unallocated CP15 encodings</i> on page B4-27</i>
<i>CP15 c15, Implementation defined registers on page B4-78</i>

B4.6.2 General behavior of CP15 registers

The following sections give information about the general behavior of CP15 registers:

- *Unpredictable and undefined behavior for CP15 accesses*
- *Reset behavior of CP15 registers on page B4-27*

See also *Meaning of fixed bit values in register diagrams* on page B4-29.

Read-only bits in read/write registers

Some read/write registers include bits that are read-only. These bits ignore writes.

An example of this is the SCTL.R.NMFI bit, bit [27], see *c1, System Control Register (SCTLR)* on page B4-45.

UNPREDICTABLE and UNDEFINED behavior for CP15 accesses

In ARMv7 the following operations are UNDEFINED:

- all CDP, MCRR, MRRC, LDC and STC operations to CP15
- all CDP2, MCR2, MRC2, MCRR2, MRRC2, LDC2 and STC2 operations to CP15.

Unless otherwise indicated in the individual register descriptions:

- reserved fields in registers are UNK/SBZP
- reserved values of fields can have UNPREDICTABLE effects.

The following subsections give more information about UNPREDICTABLE and UNDEFINED behavior for CP15:

- *Unallocated CP15 encodings on page B4-27*
- *Rules for MCR and MRC accesses to CP15 registers on page B4-27.*

Unallocated CP15 encodings

When MCR and MRC instructions perform CP15 operations, the <CRn> value for the instruction is the major register specifier for the CP15 space. Accesses to unallocated major registers are UNDEFINED. For the ARMv7-R Architecture, this means that accesses with <CRn> = {c2-c4, c8, c10, c12, c14} are UNDEFINED.

In an allocated CP15 major register specifier, MCR and MRC accesses to all unallocated encodings are UNPREDICTABLE for privileged accesses. For the ARMv7-A architecture this means that privileged MCR and MRC accesses with <CRn> != {c2-c4, c8, c10, c12, c14} but with an unallocated combination of <opc1>, <CRm> and <opc2> values, are UNPREDICTABLE. For <CRn> != {c2-c4, c8, c10, c12, c14}, Figure B4-3 on page B4-23 shows all allocated allocations of <opc1>, <CRm> and <opc2>. A privileged access using any combination not show in the figure is UNPREDICTABLE.

Note

As shown in Figure B4-3 on page B4-23, accesses to unallocated principal ID registers map onto the Main ID Register. These are accesses with <CRn> = c0, <opc1> = 0, <CRm> = c0, and <opc2> = {4, 6, 7}.

Rules for MCR and MRC accesses to CP15 registers

All MCR operations from the PC are UNPREDICTABLE for all coprocessors, including for CP15.

All MRC operations to APSR_nzcv are UNPREDICTABLE for CP15.

The following accesses are UNPREDICTABLE:

- an MCR access to an encoding for which no write behavior is defined in any circumstances
- an MRC access to an encoding for which no read behavior is defined in any circumstances.

Except for CP15 encoding that are accessible in User mode, all MCR and MRC accesses from User mode are UNDEFINED. This applies to all User mode accesses to unallocated CP15 encodings. Individual register descriptions, and the summaries of the CP15 major registers, show the CP15 encodings that are accessible in User mode.

Some individual registers can be made inaccessible by setting configuration bits, possibly including IMPLEMENTATION DEFINED configuration bits, to disable access to the register. The effects of the architecturally-defined configuration bits are defined individually in this manual. Typically, setting a configuration bit to disable access to a register results in the register becoming UNDEFINED for MRC and MCR accesses.

Reset behavior of CP15 registers

After a reset, only a limited subset of the processor state is guaranteed to be set to defined values. On reset, the PMSAv7 architecture requires that the following CP15 registers are set to defined values:

- the SCTLR, see *c1, System Control Register (SCTLR)* on page B4-45
- the CPACR, see *c1, Coprocessor Access Control Register (CPACR)* on page B4-51
- the DRSR, see *c6, Data Region Size and Enable Register (DRSR)* on page B4-62
- the IRSR, if implemented, see *c6, Instruction Region Size and Enable Register (IRSR)* on page B4-63.

For details of the reset values of these registers see the register descriptions.

After a reset, software must not rely on the value of any read/write register not included in this list.

B4.6.3 Changes to CP15 registers and the memory order model

All changes to CP15 registers that appear in program order after any explicit memory operations are guaranteed not to affect those memory operations.

Any change to CP15 registers is guaranteed to be visible to subsequent instructions only after one of:

- the execution of an ISB instruction
- the taking of an exception
- the return from an exception.

To guarantee the visibility of changes to some CP15 registers, additional operations might be required, on a case by case basis, before the ISB instruction, exception or return from exception. These cases are identified specifically in the definition of the registers.

However, for CP15 register accesses, all MRC and MCR instructions to the same register using the same register number appear to occur in program order relative to each other without context synchronization.

Where a change to the CP15 registers that is not yet guaranteed to be visible has an effect on exception processing, the following rule applies:

- When it is determined that an exception must be taken, any change of state held in CP15 registers involved in the triggering of the exception and that affects the processing of the exception is guaranteed to take effect before the exception is taken.

Therefore, in the following example, where initially A=1 and V=0, the LDR might or might not take a Data Abort exception due to the unaligned access, but if an exception occurs, the vector used is affected by the V bit:

```
MCR p15, R0, c1, c0, 0    ; clears the A bit and sets the V bit
LDR R2, [R3]              ; unaligned load.
```

B4.6.4 Meaning of fixed bit values in register diagrams

In register diagrams, fixed bits are indicated by one of following:

- 0** In any implementation:
- the bit must read as 0
 - writes to the bit must be ignored.
- Software:
- can rely on the bit reading as 0
 - must use an SBZP policy to write to the bit.
- (0)** In any implementation:
- the bit must read as 0
 - writes to the bit must be ignored.
- Software:
- must not rely on the bit reading as 0
 - must use an SBZP policy to write to the bit.
- 1** In any implementation:
- the bit must read as 1
 - writes to the bit must be ignored.
- Software:
- can rely on the bit reading as 1
 - must use an SBOP policy to write to the bit.
- (1)** In any implementation:
- the bit must read as 1
 - writes to the bit must be ignored.
- Software:
- must not rely on the bit reading as 1
 - must use an SBOP policy to write to the bit.

Fields that are more than 1 bit wide are sometimes described as UNK/SBZP, instead of having each bit marked as (0).

B4.6.5 CP15 c0, ID codes registers

The CP15 c0 registers are used for processor and feature identification. Figure B4-4 shows the CP15 c0 registers.

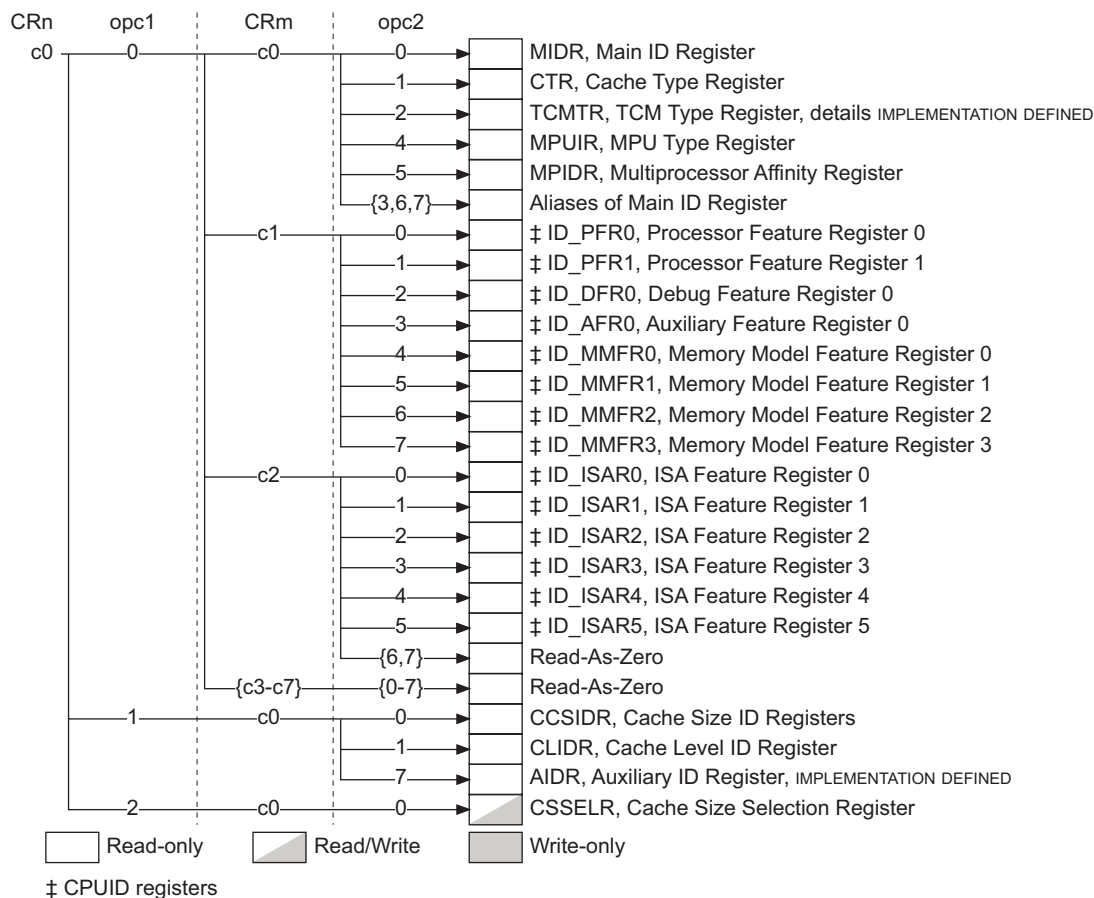

Figure B4-4 CP15 c0 registers in a PMSA implementation

All CP15 c0 register encodings not shown in Figure B4-4 are UNPREDICTABLE, see *Unallocated CP15 encodings* on page B4-27.

Note

Chapter B5 *The CPUID Identification Scheme* describes the CPUID registers shown in Figure B4-4.

Table B4-9 lists the CP15 c0 registers and shows where each register is described in full. The table does not include the reserved and aliased registers that are shown in Figure B4-4 on page B4-30.

Table B4-9 Index to CP15 c0 register descriptions

opc1	CRm	opc2	Register and description
0	c0	0	<i>c0</i> , Main ID Register (MIDR) on page B4-32
		1	<i>c0</i> , Cache Type Register (CTR) on page B4-34
		2	<i>c0</i> , TCM Type Register (TCMTR) on page B4-35
		4	<i>c0</i> , MPU Type Register (MPUIR) on page B4-36
		5	<i>c0</i> , Multiprocessor Affinity Register (MPIDR) on page B4-37
		3, 6, 7	<i>c0</i> , Main ID Register (MIDR) on page B4-32
		c1	0, 1
	2		<i>c0</i> , Debug Feature Register 0 (ID_DFR0) on page B5-6
	3		<i>c0</i> , Auxiliary Feature Register 0 (ID_AFR0) on page B5-8
	c2	4-7	CP15 c0, Memory Model Feature registers on page B5-9
0-5		CP15 c0, Instruction Set Attribute registers on page B5-19	
1	c0	0	<i>c0</i> , Cache Size ID Registers (CCSIDR) on page B4-40
		1	<i>c0</i> , Cache Level ID Register (CLIDR) on page B4-41
		7	<i>c0</i> , Implementation defined Auxiliary ID Register (AIDR) on page B4-43
2	c0	0	<i>c0</i> , Cache Size Selection Register (CSSELR) on page B4-43

Note

The CPUID scheme described in Chapter B5 *The CPUID Identification Scheme* includes information about the implementation of the optional Floating-Point and Advanced SIMD architecture extensions. See *Advanced SIMD and VFP extensions* on page A2-20 for a summary of the implementation options for these features.

B4.6.6 c0, Main ID Register (MIDR)

The Main ID Register, MIDR, provides identification information for the processor, including an implementer code for the device and a device ID number.

The MIDR is:

- a 32-bit read-only register
- accessible only in privileged modes.

Some fields of the MIDR are IMPLEMENTATION DEFINED. For details of the values of these fields for a particular ARMv7 implementation, and any implementation-specific significance of these values, see the product documentation.

The format of the MIDR is:

31	24 23	20 19	16 15	4 3	0
Implementer	Variant	Architecture	Primary part number	Revision	

Implementer, bits [31:24]

The Implementer code. Table B4-10 shows the permitted values for this field:

Table B4-10 Implementer codes

Bits [31:24]	ASCII character	Implementer
0x41	A	ARM Limited
0x44	D	Digital Equipment Corporation
0x4D	M	Motorola, Freescale Semiconductor Inc.
0x51	Q	QUALCOMM Inc.
0x56	V	Marvell Semiconductor Inc.
0x69	i	Intel Corporation

All other values are reserved by ARM and must not be used.

Variant, bits [23:20]

An IMPLEMENTATION DEFINED variant number. Typically, this field is used to distinguish between different product variants, for example implementations of the same product with different cache sizes.

Architecture, bits [19:16]

Table B4-11 shows the permitted values for this field:

Table B4-11 Architecture codes

Bits [19:16]	Architecture
0x1	ARMv4
0x2	ARMv4T
0x3	ARMv5 (obsolete)
0x4	ARMv5T
0x5	ARMv5TE
0x6	ARMv5TEJ
0x7	ARMv6
0xF	Defined by CPUID scheme

All other values are reserved by ARM and must not be used.

Primary part number, bits [15:4]

An IMPLEMENTATION DEFINED primary part number for the device.

Note

On processors implemented by ARM, if the top four bits of the primary part number are 0x0 or 0x7, the variant and architecture are encoded differently, see *c0, Main ID Register (MIDR)* on page AppxH-34. Processors implemented by ARM have an Implementer code of 0x41.

Revision, bits [3:0]

An IMPLEMENTATION DEFINED revision number for the device.

ARMv7 requires all implementations to use the CPUID scheme, described in Chapter B5 *The CPUID Identification Scheme*, and an implementation is described by the MIDR and the CPUID registers.

Note

For an ARMv7 implementation by ARM, the MIDR is interpreted as:

- Bits [31:24]** Implementer code, must be 0x41.
- Bits [23:20]** Major revision number, rX.
- Bits [19:16]** Architecture code, must be 0xF.
- Bits [15:4]** ARM part number.
- Bits [3:0]** Minor revision number, pY.

Accessing the MIDR

To access the MIDR you read the CP15 registers with <opc1> set to 0, <CRn> set to c0, <CRm> set to c0, and <opc2> set to 0. For example:

```
MRC p15,0,<Rt>,c0,c0,0 ; Read CP15 Main ID Register
```

B4.6.7 c0, Cache Type Register (CTR)

The Cache Type Register, CTR, provides information about the architecture of the caches.

The CTR is:

- a 32-bit read-only register
- accessible only in privileged modes.

The format of the CTR is changed from ARMv7. The ARMv7 format of the register is indicated by bits [31:29] being set to 0b100. For details of the format of the Cache Type Register in versions of the ARM architecture before ARMv7 see *c0, Cache Type Register (CTR)* on page AppxH-35.

In ARMv7, the format of the CTR is:

31	29	28	27	24	23	20	19	16	15	4	3	0
1	0	0	0	CWG	ERG	DminLine	1	0	0	0	0	0
											IminLine	

Bits [31:29] Set to 0b100 for the ARMv7 register format. Set to 0b000 for the format used in ARMv6 and earlier.

Bit [28] RAZ.

CWG, bits [27:24]

Cache Writeback Granule. \log_2 of the number of words of the maximum size of memory that can be overwritten as a result of the eviction of a cache entry that has had a memory location in it modified.

A value of 0b0000 indicates that the CTR does not provide Cache Writeback Granule information and either:

- the architectural maximum of 512 words (2Kbytes) must be assumed
- the Cache Writeback Granule can be determined from maximum cache line size encoded in the Cache Size ID Registers.

Values greater than 0b1001 are reserved.

ERG, bits [27:24]

Exclusives Reservation Granule. \log_2 of the number of words of the maximum size of the reservation granule that has been implemented for the Load-Exclusive and Store-Exclusive instructions. For more information, see *Tagging and the size of the tagged memory block* on page A3-20.

A value of 0b0000 indicates that the CTR does not provide Exclusives Reservation Granule information and the architectural maximum of 512 words (2Kbytes) must be assumed.

Values greater than 0b1001 are reserved.

DminLine, bits [19:16]

\log_2 of the number of words in the smallest cache line of all the data caches and unified caches that are controlled by the processor.

Bit [15] RAO.

Bits [14:4] RAZ.

IminLine, bits [3:0]

\log_2 of the number of words in the smallest cache line of all the instruction caches that are controlled by the processor.

Accessing the CTR

To access the CTR you read the CP15 registers with <opc1> set to 0, <CRn> set to c0, <CRm> set to c0, and <opc2> set to 1. For example

```
MRC p15,0,<Rt>,c0,c0,1 ; Read CP15 Cache Type Register
```

B4.6.8 c0, TCM Type Register (TCMTR)

The TCM Type Register, TCMTR, provides information about the implementation of the TCM.

The TCMTR is:

- a 32-bit read-only register
- accessible only in privileged modes.

From ARMv7:the

- TCMTR must be implemented
- when the ARMv7 format is used, the meaning of register bits [28:0] is IMPLEMENTATION DEFINED
- the ARMv6 format of the TCM Type Register remains a valid usage model
- if no TCMs are implemented the ARMv6 format must be used to indicate zero-sized TCMs.

The ARMv7 format of the TCMTR is:

31	29	28	0
1	0	0	IMPLEMENTATION DEFINED

Bits [31:29] Set to 0b100 for the ARMv7 register format. Set to 0b000 for the format used in ARMv6 and earlier.

Bits [28:0] IMPLEMENTATION DEFINED in the ARMv7 register format.

If no TCMs are implemented, the TCMTR must be implemented with this ARMv6 format:

31	29 28	19 18	16 15	3 2	0
0 0 0	UNKNOWN	0 0 0	UNKNOWN	0 0 0	0

For details of the ARMv6 optional implementation of the TCM Type Register see *c0, TCM Type Register (TCMTR)* on page AppxG-33.

Accessing the TCMTR

To access the TCMTR you read the CP15 registers with <opc1> set to 0, <CRn> set to c0, <CRm> set to c0, and <opc2> set to 2. For example:

```
MRC p15,0,<Rt>,c0,c0,2 ; Read CP15 TCM Type Register
```

B4.6.9 c0, MPU Type Register (MPUIR)

The MPU Type Register, MPUIR, identifies the features of the MPU implementation. In particular it identifies:

- whether the MPU implements:
 - a Unified address map, also referred to as a von Neumann architecture
 - separate Instruction and Data address maps, also referred to as a Harvard architecture.
- the number of memory regions implemented by the MPU.

The MPUIR is:

- a 32-bit read-only register
- accessible only in privileged modes
- implemented only when the PMSA is implemented.

The format of the MPUIR is:

31	24 23	16 15	8 7	1 0
UNKNOWN	IRegion	DRegion	UNKNOWN	nU

Bits [31:24] UNKNOWN.

IRegion, bits [23:16]

Specifies the number of Instruction regions implemented by the MPU.

If the MPU implements a Unified memory map this field is UNK/~~SBZ~~.

DRegion, bits [15:8]

Specifies the number of Data or Unified regions implemented by the MPU.

If this field is zero, no MPU is implemented, and the default memory map is in use.

Bits [7:1] UNKNOWN.

nU, bit [0] Not Unified MPU. Indicates whether the MPU implements a unified memory map:
nU == 0 Unified memory map. Bits [23:16] of the register are zero.
nU == 1 Separate Instruction and Data memory maps.

Accessing the MPUIR

To access the MPUIR you read the CP15 registers with <opc1> set to 0, <CRn> set to c0, <CRm> set to c0, and <opc2> set to 4. For example:

```
MRC p15,0,<Rt>,c0,c0,4 ; Read CP15 MPU Type Register
```

B4.6.10 c0, Multiprocessor Affinity Register (MPIDR)

The Multiprocessor Affinity Register, MPIDR, provides an additional processor identification mechanism for scheduling purposes in a multiprocessor system. In a uniprocessor system ARM recommends that this register returns a value of 0.

The MPIDR is:

- a 32-bit read-only register
- accessible only in privileged modes
- introduced in ARMv7.

The format of the MPIDR is:

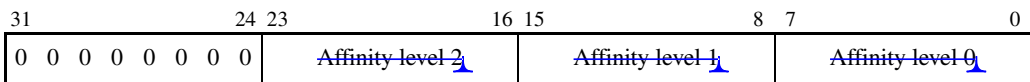

———— Note ————

In the MIDR bit definitions, a *processor in the system* can be a physical processor or a virtual processor.

Bits [31:24] Reserved, RAZ.

Affinity level 2, bits [23:16]

The least significant affinity level field, for this processor in the system.

Affinity level 1, bits [15:8]

The intermediate affinity level field, for this processor in the system.

Affinity level 0, bits [7:0]

The most significant level field, for this processor in the system.

In the system as a whole, for each of the affinity level fields, the assigned values must start at 0 and increase monotonically.

~~Increasing monotonically means that:~~

- ~~• There must not be any gaps in the sequence of numbers used.~~
- ~~• A higher value of the field includes any properties indicated by all lower values of the field.~~

When matching against an affinity level field, scheduler software checks for a value equal to or greater than a required value.

Recommended use of the MPIDR includes a description of an example multiprocessor system and the affinity level field values it might use.

The interpretation of these fields is IMPLEMENTATION DEFINED, and must be documented as part of the documentation of the multiprocessor system. ARM recommends that this register might be used as described in the next subsection.

The software mechanism to discover the total number of affinity numbers used at each level is IMPLEMENTATION DEFINED, and is part of the general system identification task.

Recommended use of the MPIDR

In a multiprocessor system the register might provide two important functions:

- Identifying special functionality of a particular processor in the system. In general, the actual meaning of the affinity level fields is not important. In a small number of situations, an affinity level field value might have a special IMPLEMENTATION DEFINED significance. Possible examples include booting from reset and power-down events.
- Providing affinity information for the scheduling software, to help the scheduler run an individual thread or process on either:
 - the same processor, or as similar a processor as possible, as the processor it was running on previously
 - a processor on which a related thread or process was run.

————— Note —————

~~A monotonically increasing single number ID mechanism provides a convenient index into software arrays and for accessing the interrupt controller. This might be:~~

- ~~• performed as part of the boot sequence~~
 - ~~• stored as part of the local storage of threads.~~
-

MPIDR provides a mechanism with up to three levels of affinity information, but the meaning of those levels of affinity is entirely IMPLEMENTATION DEFINED. The levels of affinity provided can have different meanings. Table B4-12 shows two possible implementations:

Table B4-12 Possible implementations of the affinity levels

Affinity Level	Example system 1	Example system 2
0	Virtual CPUs in a in a multi-threaded processor	Processors in an SMP cluster
1	Processors in an <i>Symmetric Multi Processor (SMP)</i> cluster	Clusters with a system
2	Clusters in a system	No meaning, fixed as 0.

The scheduler maintains affinity level information for all threads and processes. When it has to reschedule a thread or process the scheduler:

- looks for an available processor that matches at all three affinity levels
- if this fails, it might look for a processor that matches at levels 2 and 3 only
- if it still cannot find an available processor it might look for a match at level 3 only.

A multiprocessor system corresponding to Example system 1 in Table B4-12 might implement affinity values as shown in Table B4-13:

Table B4-13 Example of possible affinity values at different affinity levels

Affinity level 2, Cluster level	Affinity level 1, Processor level	Affinity level 0, Virtual CPU level
0	0	0, 1
0	1	0, 1
0	2	0, 1
0	3	0, 1
1	0	0, 1
1	1	0, 1
1	2	0, 1
1	3	0, 1

Accessing the MPIDR

To access the MPIDR you read the CP15 registers with <opc1> set to 0, <CRn> set to c0, <CRm> set to c0, and <opc2> set to 5. For example:

```
MRC p15,0,<Rt>,c0,c0,5 ; Read Multiprocessor Affinity Register
```

B4.6.11 c0, Cache Size ID Registers (CCSIDR)

The Cache Size ID Registers, CCSIDR, provide information about the architecture of the caches.

The CCSIDR registers are:

- 32-bit read-only registers
- accessible only in privileged modes
- introduced in ARMv7.

One CCSIDR is implemented for each cache that can be accessed by the processor. CSSELR selects which Cache Size ID register is accessible, see *c0, Cache Size Selection Register (CSSELR)* on page B4-43.

The format of a CCSIDR is:

31	30	29	28	27	13	12	3	2	0
W T	W B	R A	W A	NumSets			Associativity		LineSize

WT, bit [31] Indicates whether the cache level supports Write-Through, see Table B4-14.

WB, bit [30] Indicates whether the cache level supports Write-Back, see Table B4-14.

RA, bit [29] Indicates whether the cache level supports Read-Allocation, see Table B4-14.

WA, bit [28] Indicates whether the cache level supports Write-Allocation, see Table B4-14.

Table B4-14 WT, WB, RA and WA bit values

WT, WB, RA or WA bit value	Meaning
0	Feature not supported
1	Feature supported

NumSets, bits [27:13]

(Number of sets in cache) - 1, therefore a value of 0 indicates 1 set in the cache. The number of sets does not have to be a power of 2.

Associativity, bits [12:3]

(Associativity of cache) - 1, therefore a value of 0 indicates an associativity of 1. The associativity does not have to be a power of 2.

LineSize, bits [2:0]

$(\text{Log}_2(\text{Number of words in cache line})) - 2$. For example:

- For a line length of 4 words: $\text{Log}_2(4) = 2$, LineSize entry = 0. This is the minimum line length.
- For a line length of 8 words: $\text{Log}_2(8) = 3$, LineSize entry = 1.

Accessing the currently selected CCSIDR

The CSSELR selects a CCSIDR, see *c0, Cache Size Selection Register (CSSELR)* on page B4-43. To access the currently-selected CCSIDR you read the CP15 registers with <opc1> set to 1, <CRn> set to c0, <CRm> set to c0, and <opc2> set to 0. For example:

MRC p15,1,<Rt>,c0,c0,0 ; Read current CP15 Cache Size ID Register

Accessing the CCSIDR when the value in CSSELR corresponds to a cache that is not implemented returns an UNKNOWN value.

B4.6.12 c0, Cache Level ID Register (CLIDR)

The Cache Level ID Register, CLIDR:

- identifies the type of cache, or caches, implemented at each level, up to a maximum of eight levels
- identifies the Level of Coherency and Level of Unification for the cache hierarchy.

The CLIDR is:

- a 32-bit read-only register
- accessible only in privileged modes
- introduced in ARMv7.

The format of the CLIDR is:

31	30	29	27	26	24	23	21	20	18	17	15	14	12	11	9	8	6	5	3	2	0
0	0	LoUU	LoC	LoUIS	Ctype7	Ctype6	Ctype5	Ctype4	Ctype3	Ctype2	Ctype1										

Bits [31:30] RAZ.

LoUU, bits [29:27]

Level of Unification Uniprocessor for the cache hierarchy, see *Clean, Invalidate, and Clean and Invalidate* on page B2-11.

LoC, bits [26:24]

Level of Coherency for the cache hierarchy, see *Clean, Invalidate, and Clean and Invalidate* on page B2-11.

LoUIS, bits [23:21]

Level of Unification Inner Shareable for the cache hierarchy, see *Clean, Invalidate, and Clean and Invalidate* on page B2-11. This field is RAZ in implementations that do not implement the Multiprocessing extension.

CtypeX, bits $[3(x - 1) + 2:3(x - 1)]$, for $x = 1$ to 7

Cache type fields. Indicate the type of cache implemented at each level, from Level 1 up to a maximum of seven levels of cache hierarchy. The Level 1 cache type field, Ctype1, is bits [2:0], see register diagram. Table B4-15 shows the possible values for each CtypeX field.

Table B4-15 Ctype bit values

CtypeX bits	Meaning, cache implemented at this level
000	No cache
001	Instruction cache only
010	Data cache only
011	Separate instruction and data caches
100	Unified cache
101, 11X	Reserved

If you read the Cache type fields from Ctype1 upwards, once you have seen a value of 0b000, no caches exist at further out levels of the hierarchy. So, for example, if Ctype3 is the first Cache type field with a value of 0b000, the values of Ctype4 to Ctype7 must be ignored.

The CLIDR describes only the caches that are under the control of the processor.

Accessing the CLIDR

To access the CLIDR you read the CP15 registers with <opc1> set to 1, <CRn> set to c0, <CRm> set to c0, and <opc2> set to 1. For example:

```
MRC p15,1,<Rt>,c0,c0,1 ; Read CP15 Cache Level ID Register
```

B4.6.13 c0, IMPLEMENTATION DEFINED Auxiliary ID Register (AIDR)

The IMPLEMENTATION DEFINED Auxiliary ID Register, AIDR, provides implementation-specific ID information. The value of this register must be used in conjunction with the value of the MIDR.

The IMPLEMENTATION DEFINED AIDR is:

- a 32-bit read-only register
- accessible only in privileged modes
- introduced in ARMv7.

The format of the AIDR is IMPLEMENTATION DEFINED.

Accessing the AIDR

To access the AIDR you read the CP15 registers with <opc1> set to 1, <CRn> set to c0, <CRm> set to c0, and <opc2> set to 7. For example:

```
MRC p15,1,<Rt>,c0,c0,7 ; Read IMPLEMENTATION DEFINED Auxiliary ID Register
```

B4.6.14 c0, Cache Size Selection Register (CSSELR)

The Cache Size Selection Register, CSSELR, selects the current CCSIDR. An ARMv7 implementation must include a CCSIDR for every implemented cache that is under the control of the processor. The CSSELR identifies which CCSIDR can be accessed, by specifying, for the required cache:

- the cache level
- the cache type, either:
 - instruction cache.
 - Data cache. The data cache argument is also used for a unified cache.

CSSELR is:

- a 32-bit read/write register
- accessible only in privileged modes
- introduced in ARMv7.

The format of the CSSELR is:

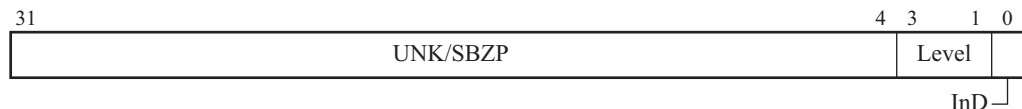

Bits [31:4] UNK/SBZP.

Level, bits [3:1]

Cache level of required cache. Permitted values are from 0b000, indicating Level 1 cache, to 0b110 indicating Level 7 cache.

InD, bit [0]

Instruction not data bit. Permitted values are:

- 0** Data or unified cache
- 1** Instruction cache.

If CSSELR is set to indicate a cache that is not implemented, the result of reading the current CCSIDR is UNPREDICTABLE.

Accessing CSSELR

To access CSSELR you read or write the CP15 registers with <opc1> set to 2, <CRn> set to c0, <CRm> set to c0, and <opc2> set to 0. For example:

```
MRC p15,2,<Rt>,c0,c0,0 ; Read Cache Size Selection Register
MCR p15,2,<Rt>,c0,c0,0 ; Write Cache Size Selection Register
```

B4.6.15 CP15 c1, System control registers

The CP15 c1 registers are used for system control. Figure B4-5 shows the CP15 c1 registers.

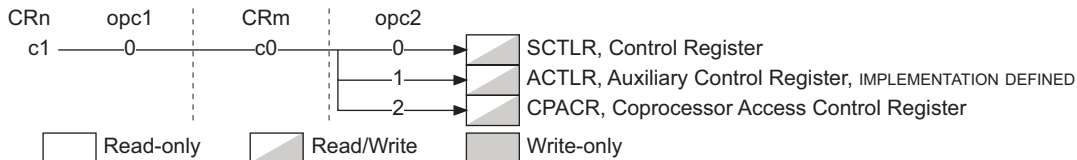

Figure B4-5 CP15 c1 registers in a PMSA implementation

All CP15 c1 register encodings not shown in Figure B4-5 are UNPREDICTABLE, see *Unallocated CP15 encodings* on page B4-27.

B4.6.16 c1, System Control Register (SCTLR)

The System Control Register, SCTLR, provides the top level control of the system, including its memory system.

The SCTLR:

- Is a 32-bit read/write register, with different access rights for some bits of the register.
In ARMv7, some bits in the register are read-only. These bits relate to non-configurable features of an ARMv7 implementation, and are provided for compatibility with previous versions of the architecture.
- Is accessible only in privileged modes.
- Has a defined reset value. The reset value is IMPLEMENTATION DEFINED, see *Reset value of the SCTLR* on page B4-49.

Control bits in the SCTLR that are not applicable to a PMSA implementation read as the value that most closely reflects that implementation, and ignore writes.

In an ARMv7-R implementation the format of the SCTLR is:

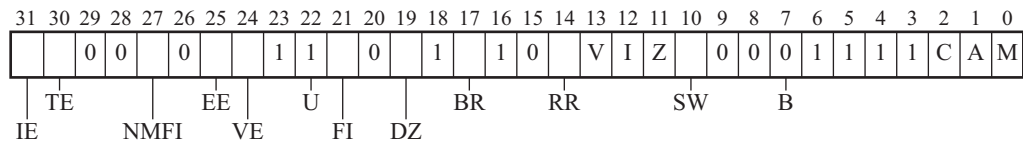

IE, bit [31] Instruction Endianness. This bit indicates the endianness of the instructions issued to the processor:

- 0** Little-endian byte ordering in the instructions
- 1** Big-endian byte ordering in the instructions.

When set, this bit causes the byte order of instructions to be reversed at runtime.

This bit is read-only. It is IMPLEMENTATION DEFINED which instruction endianness is used by an ARMv7-R implementation, and this bit must indicate the implemented endianness.

If IE == 1 and EE == 0, behavior is UNPREDICTABLE.

TE, bit [30] Thumb Exception enable. This bit controls whether exceptions are taken in ARM or Thumb state:

- 0** Exceptions, including reset, handled in ARM state
- 1** Exceptions, including reset, handled in Thumb state.

An implementation can include a configuration input signal that determines the reset value of the TE bit. If the implementation does not include a configuration signal for this purpose then this bit resets to zero in an ARMv7-R implementation.

For more information about the use of this bit see *Instruction set state on exception entry* on page B1-35.

Bits [29:28] RAZ/SBZP.

NMFI, bit [27]

Non-Maskable ~~Fast Interrupts enable:~~

0 ~~Fast interrupts (FIQs) can be masked in the CPSR~~

1 ~~Fast interrupts are non-maskable.~~

This bit is read-only. It is IMPLEMENTATION DEFINED whether an implementation supports *Non-Maskable Fast Interrupts* (NMFIs):

- If NMFIs are not supported then this bit is RAZ/WI.
- If NMFIs are supported then this bit is determined a configuration input signal.

For more information, see *Non-maskable fast interrupts* on page B1-18.

Bit [26] RAZ/SBZP.

EE, bit [25] Exception Endianness bit. The value of this bit defines the value of the CPSR.E bit on entry to an exception vector, including reset. The permitted values of this bit are:

0 Little endian

1 Big endian.

This is a read/write bit. An implementation can include a configuration input signal that determines the reset value of the EE bit. If the implementation does not include a configuration signal for this purpose then this bit resets to zero.

If IE == 1 and EE == 0, behavior is UNPREDICTABLE.

VE, bit [24] Interrupt Vectors Enable bit. This bit controls the vectors used for the FIQ and IRQ interrupts. The permitted values of this bit are:

0 Use the FIQ and IRQ vectors from the vector table, see the V bit entry

1 Use the IMPLEMENTATION DEFINED values for the FIQ and IRQ vectors.

For more information, see *Vectored interrupt support* on page B1-32.

If the implementation does not support IMPLEMENTATION DEFINED FIQ and IRQ vectors then this bit is RAZ/WI.

Bit [23] RAO/SBOP.

U, bit [22] In ARMv7 this bit is RAO/SBOP, indicating use of the alignment model described in *Alignment support* on page A3-4.

For details of this bit in earlier versions of the architecture see *Alignment* on page AppxG-6.

FI, bit [21] Fast Interrupts configuration enable bit. This bit can be used to reduce interrupt latency in an implementation by disabling IMPLEMENTATION DEFINED performance features. The permitted values of this bit are:

0 All performance features enabled.

1 Low interrupt latency configuration. Some performance features disabled.

If the implementation does not support a mechanism for selecting a low interrupt latency configuration this bit is RAZ/WI.

For more information, see *Low interrupt latency configuration* on page B1-43.



- Bit [20]** RAZ/SBZP.
- DZ, bit [19]** Divide by Zero fault enable bit. Any ARMv7-R implementation includes instructions to perform unsigned and signed division, see *SDIV* on page A8-310 and *UDIV* on page A8-468. This bit controls whether an integer divide by zero causes an Undefined Instruction exception:
- 0** Divide by zero returns the result zero, and no exception is taken
 - 1** Attempting a divide by zero causes an Undefined Instruction exception on the *SDIV* or *UDIV* instruction.
- Bit [18]** RAO/SBOP.
- BR, bit [17]** Background Region bit. When the MPU is enabled this bit controls how an access that does not map to any MPU memory region is handled:
- 0** Any access to an address that is not mapped to an MPU region generates a Background Fault memory abort. This is the PMSAv6 behavior.
 - 1** The default memory map is used as a background region:
 - A privileged access to an address that does not map to an MPU region takes the properties defined for that address in the default memory map.
 - An unprivileged access to an address that does not map to an MPU region generates a Background Fault memory abort.
- For more information, see *Using the default memory map as a background region* on page B4-5.
- Bit [16]** RAO/SBOP.
- Bit [15]** RAZ/SBZP.
- RR, bit [14]** Round Robin bit. If the cache implementation supports the use of an alternative replacement strategy that has a more easily predictable worst-case performance, this bit selects it:
- 0** Normal replacement strategy, for example, random replacement
 - 1** Predictable strategy, for example, round-robin replacement.
- The RR bit must reset to 0.
- The replacement strategy associated with each value of the RR bit is IMPLEMENTATION DEFINED.
- If the implementation does not support multiple IMPLEMENTATION DEFINED replacement strategies this bit is RAZ/WI.
- V, bit [13]** Vectors bit. This bit selects the base address of the exception vectors:
- 0** Normal exception vectors, base address 0x00000000.
 - 1** High exception vectors (Hivecs), base address 0xFFFF0000.
- For more information, see *Exception vectors and the exception base address* on page B1-30.

Note

Use of the Hivecs setting, $V == 1$, is deprecated in an ARMv7-R implementation.

An implementation can include a configuration input signal that determines the reset value of the V bit. If the implementation does not include a configuration signal for this purpose then this bit resets to zero.

- I, bit [12]** Instruction cache enable bit: This is a global enable bit for instruction caches:
- 0** Instruction caches disabled
 - 1** Instruction caches enabled.
- If the system does not implement any instruction caches that can be accessed by the processor, at any level of the memory hierarchy, this bit is RAZ/WI.
- If the system implements any instruction caches that can be accessed by the processor then it must be possible to disable them by setting this bit to 0.
- Cache enabling and disabling* on page B2-8 describes the effect of enabling the caches.
- Z, bit [11]** Branch prediction enable bit. This bit is used to enable branch prediction, also called program flow prediction:
- 0** Program flow prediction disabled
 - 1** Program flow prediction enabled.
- If program flow prediction cannot be disabled, this bit is RAO/WI.
- If the implementation does not support program flow prediction then this bit is RAZ/WI.
- SW, bit[10]** SWP/SWPB enable bit. This bit enables the use of SWP and SWPB instructions:
- 0** SWP and SWPB are UNDEFINED
 - 1** SWP and SWPB perform as described in section *SWP, SWPB* on page A8-432.
- This bit is added as part of the Multiprocessing Extensions.

Note

At reset, this bit disables SWP and SWPB. This means that operating systems have to choose to use SWP and SWPB.

- Bits [9:8]** RAZ/SBZP.
- B, bit [7]** In ARMv7 this bit is RAZ/SBZP, indicating use of the endianness model described in *Endian support* on page A3-7.
- For details of this bit in earlier versions of the architecture see *Endian support* on page AppxG-7 and *Endian support* on page AppxH-7.
- Bits [6:3]** RAO/SBOP.

- C, bit [2]** Cache enable bit: This is a global enable bit for data and unified caches:
- 0** Data and unified caches disabled
 - 1** Data and unified caches enabled.
- If the system does not implement any data or unified caches that can be accessed by the processor, at any level of the memory hierarchy, this bit is RAZ/WI.
- If the system implements any data or unified caches that can be accessed by the processor then it must be possible to disable them by setting this bit to 0.
- Cache enabling and disabling* on page B2-8 describes the effect of enabling the caches.
- A, bit [1]** Alignment bit. This is the enable bit for Alignment fault checking:
- 0** Alignment fault checking disabled
 - 1** Alignment fault checking enabled.
- For more information, see *Alignment fault* on page B4-14.
- M, bit [0]** MPU enable bit. This is a global enable bit for the MPU:
- 0** MPU disabled
 - 1** MPU enabled.
- For more information, see *Enabling and disabling the MPU* on page B4-5.

Reset value of the SCTLR

The SCTLR has a defined reset value that is IMPLEMENTATION DEFINED. There are different types of bit in the SCTLR:

- Some bits are defined as RAZ or RAO, and have the same value in all PMSAv7 implementations. Figure B4-6 on page B4-50 shows the values of these bits.
- Some bits are read-only and either:
 - have an IMPLEMENTATION DEFINED value
 - have a value that is determined by a configuration input signal.
- Some bits are read/write and either:
 - reset to zero
 - reset to an IMPLEMENTATION DEFINED value
 - reset to a value that is determined by a configuration input signal.

Figure B4-6 on page B4-50 shows the reset value, or how the reset value is defined, for each bit of the SCTLR. It also shows the possible values of each half byte of the register.

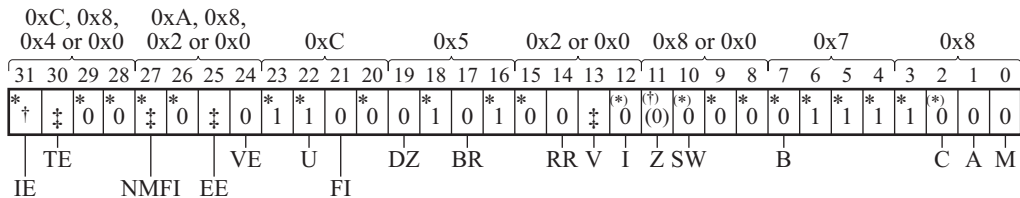

* Read-only bits, including RAZ and RAO bits.

(*) Can be RAZ. Otherwise read/write, resets to 0.

† Value is IMPLEMENTATION DEFINED.

(†) Can be read-only, with IMPLEMENTATION DEFINED value. Otherwise resets to 0.

‡ Value or reset value can depend on configuration input. Otherwise RAZ or resets to 0.

Figure B4-6 Reset value of the SCTLr, ARMv7-R (PMSAv7)

Accessing the SCTLr

To access SCTLr you read or write the CP15 registers with <opc1> set to 0, <CRn> set to c1, <CRm> set to c0, and <opc2> set to 0. For example:

```
MRC p15,0,<Rt>,c1,c0,0 ; Read CP15 System Control Register
MCR p15,0,<Rt>,c1,c0,0 ; Write CP15 System Control Register
```

———— Note ————

Additional configuration and control bits might be added to the SCTLr in future versions of the ARM architecture. ARM strongly recommends that software always uses a read, modify, write sequence to update the SCTLr. This prevents software modifying any bit that is currently unallocated, and minimizes the chance of the register update having undesired side effects.

B4.6.17 c1, IMPLEMENTATION DEFINED Auxiliary Control Register (ACTLR)

The Auxiliary Control Register, ACTLR, provides implementation-specific configuration and control options.

The ACTLR is:

- A 32-bit read/write register.
- Accessible only in privileged modes.

The contents of this register are IMPLEMENTATION DEFINED. ARMv7 requires this register to be privileged read/write accessible, even if an implementation has not created any control bits in this register.

Accessing the ACTLR

To access the ACTLR you read or write the CP15 registers with <opc1> set to 0, <CRn> set to c1, <CRm> set to c0, and <opc2> set to 1. For example:

```
MRC p15,0,<Rt>,c1,c0,1 ; Read CP15 Auxiliary Control Register
MCR p15,0,<Rt>,c1,c0,1 ; Write CP15 Auxiliary Control Register
```

B4.6.18 c1, Coprocessor Access Control Register (CPACR)

The Coprocessor Access Control Register, CPACR, controls access to all coprocessors other than CP14 and CP15. It also enables software to check for the presence of coprocessors CP0 to CP13.

The CPACR:

- is a 32-bit read/write register
- is accessible only in privileged modes.
- has a defined reset value of 0.

The format of the CPACR is:

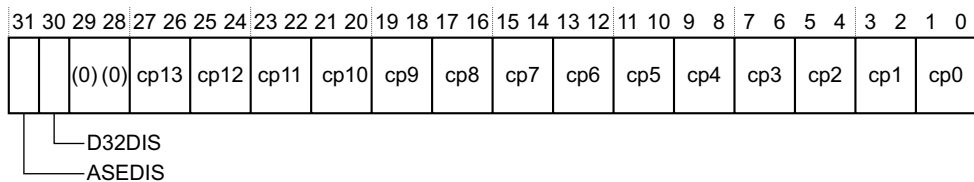

ASEDIS, bit[31]

Disable Advanced SIMD functionality:

- 0** This bit does not cause any instructions to be UNDEFINED.
- 1** All instruction encodings identified in the *Alphabetical list of instructions* on page A8-14 as being part of Advanced SIMD, but that are not VFPv3 instructions, are UNDEFINED.

On an implementation that:

- Implements VFP and does not implement Advanced SIMD, this bit is RAO/WI.
- Does not implement VFP or Advanced SIMD, this bit is UNK/SBZP.
- Implements both VFP and Advanced SIMD, it is IMPLEMENTATION DEFINED whether this bit is supported. If it is not supported it is RAZ/WI.

This bit resets to 0 if it is supported.

D32DIS, bit[30]

Disable use of D16-D31 of the VFP register file:

- 0** This bit does not cause any instructions to be UNDEFINED.
- 1** All instruction encodings identified in the *Alphabetical list of instructions* on page A8-14 as being VFPv3 instructions are UNDEFINED if they access any of registers D16-D31.

If this bit is 1 when CPACR.ASEDIS == 0, the result is UNPREDICTABLE.

On an implementation that:

- Does not implement VFP, this bit is UNK/SBZP.
- Implements VFP and does not implement D16-D31, this bit is RAO/WI.
- Implements VFP and implements D16-D31, it is IMPLEMENTATION DEFINED whether this bit is supported. If it is not supported it is RAZ/WI.

This bit resets to 0 if it is supported.

Bits [29:28] Reserved. UNK/SBZP.

cp<n>, bits [2n+1, 2n], for n = 0 to 13

Defines the access rights for coprocessor n. The possible values of the field are:

- 00** Access denied. Any attempt to access the coprocessor generates an Undefined Instruction exception.
- 01** Privileged access only. Any attempt to access the coprocessor in User mode generates an Undefined Instruction exception.
- 10** Reserved. The effect of this value is UNPREDICTABLE.
- 11** Full access. The meaning of full access is defined by the appropriate coprocessor.

The value for a coprocessor that is not implemented is 00, access denied.

If more than one coprocessor is used to provide a set of functionality then having different values for the CPACR fields for those coprocessors can lead to UNPREDICTABLE behavior. An example where this must be considered is with the VFP extension, that uses CP10 and CP11.

Typically, an operating system uses this register to control coprocessor resource sharing among applications:

- Initially all applications are denied access to the shared coprocessor-based resources.
- When an application attempts to use a resource it results in an Undefined Instruction exception.
- The Undefined Instruction handler can then grant access to the resource by setting the appropriate field in the CPACR.

For details of how this register can be used to check for implemented coprocessors see *Access controls on CP0 to CP13* on page B1-63.

Sharing resources among applications requires a state saving mechanism. Two possibilities are:

- during a context switch, if the last executing process or thread had access rights to a coprocessor then the operating system saves the state of that coprocessor
- on receiving a request for access to a coprocessor, the operating system saves the old state for that coprocessor with the last process or thread that accessed it.

Accessing the CPACR

To access the CPACR you read or write the CP15 registers with <opc1> set to 0, <CRn> set to c1, <CRm> set to c0, and <opc2> set to 2. For example:

```
MRC p15,0,<Rt>,c1,c0,2    ; Read CP15 Coprocessor Access Control Register
MCR p15,0,<Rt>,c1,c0,2    ; Write CP15 Coprocessor Access Control Register
```

Normally, software uses a read, modify, write sequence to update the CPACR, to avoid unwanted changes to the access settings for other coprocessors.

B4.6.19 CP15 c2 and c3, Not used on a PMSA implementation

The CP15 c2 and c3 register encodings are not used on an ARMv7-R implementation, see *Unallocated CP15 encodings* on page B4-27.

B4.6.20 CP15 c4, Not used

The CP15 c4 register encodings are not used on an ARMv7 implementation, see *Unallocated CP15 encodings* on page B4-27.

B4.6.21 CP15 c5 and c6, Memory system fault registers

The CP15 c5 and c6 registers are used for memory system fault reporting. In addition, c6 provides the MPU Region registers. Figure B4-7 on page B4-54 shows the CP15 c5 and c6 registers.

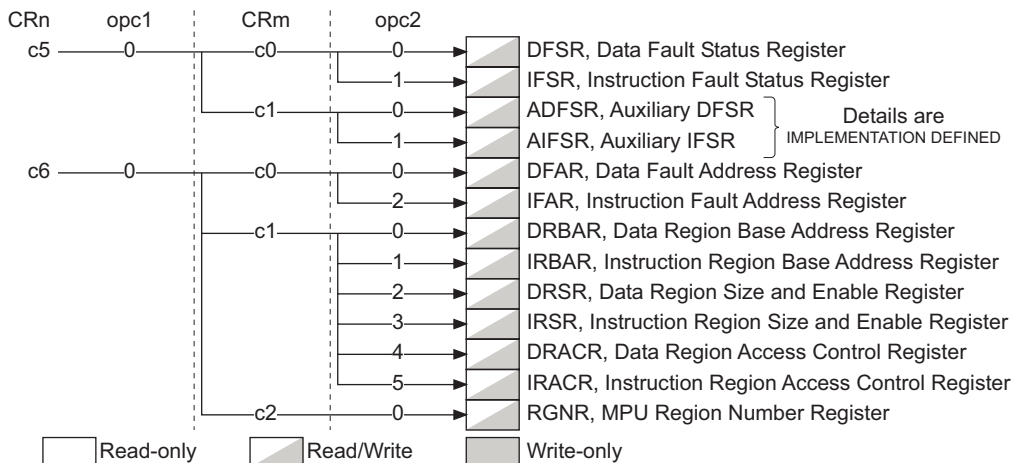

Figure B4-7 CP15 c5 and c6 registers in a PMSA implementation

All CP15 c5 and c6 register encodings not shown in Figure B4-7 are UNPREDICTABLE, see *Unallocated CP15 encodings* on page B4-27.

The CP15 c5 and c6 registers are described in:

- *CP15 c5, Fault status registers*
- *CP15 c6, Fault Address registers* on page B4-57
- *CP15 c6, Memory region programming registers* on page B4-59.

Also, these registers are used to report information about debug exceptions. For details see *Effects of debug exceptions on CP15 registers and the DBGWFA* on page C4-4.

B4.6.22 CP15 c5, Fault status registers

There are two fault status registers, in CP15 c5, and the architecture provides encodings for two additional IMPLEMENTATION DEFINED registers. Table B4-16 summarizes these registers.

Table B4-16 Fault status registers

Register name	Description
Data Fault Status Register (DFSR)	<i>c5, Data Fault Status Register (DFSR)</i> on page B4-55
Instruction Fault Status Register (IFSR)	<i>c5, Instruction Fault Status Register (IFSR)</i> on page B4-56
Auxiliary Data Fault Status Register (ADFSR)	<i>c5, Auxiliary Data and Instruction Fault Status Registers (ADFSR and AIFSR)</i> on page B4-56
Auxiliary Instruction Fault Status Register (AIFSR)	

Fault information is returned using the fault status registers and the fault address registers described in *CP15 c6, Fault Address registers* on page B4-57. For details of how these registers are used see *Fault Status and Fault Address registers in a PMSA implementation* on page B4-18.

c5, Data Fault Status Register (DFSR)

The Data Fault Status Register, DFSR, holds status information about the last data fault.

The DFSR is:

- a 32-bit read/write register
- accessible only in privileged modes.

The format of the DFSR is:

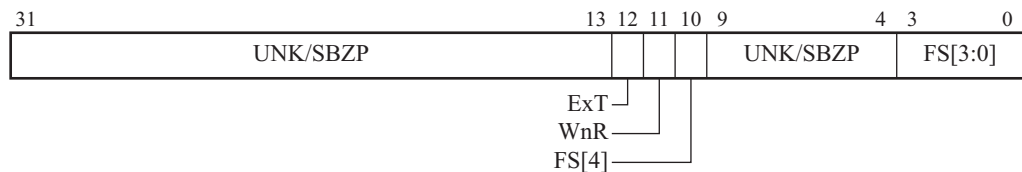

Bits [31:13,9:4]

UNK/SBZP.

ExT, bit [12] External abort type. This bit can be used to provide an IMPLEMENTATION DEFINED classification of external aborts.

For aborts other than external aborts this bit always returns 0.

WnR, bit [11] Write not Read bit. Indicates whether the abort was caused by a write or a read access:

- 0** Abort caused by a read access
- 1** Abort caused by a write access.

For faults on CP15 cache maintenance operations this bit always returns a value of 1.

FS, bits [10,3:0]

Fault status bits. For the valid encodings of these bits in an ARMv7-R implementation with a PMSA, see Table B4-7 on page B4-20.

All encodings not shown in the table are reserved.

For information about using the DFSR see *Fault Status and Fault Address registers in a PMSA implementation* on page B4-18.

Accessing the DFSR

To access the DFSR you read or write the CP15 registers with <opc1> set to 0, <CRn> set to c5, <CRm> set to c0, and <opc2> set to 0. For example:

```
MRC p15,0,<Rt>,c5,c0,0 ; Read CP15 Data Fault Status Register
MCR p15,0,<Rt>,c5,c0,0 ; Write CP15 Data Fault Status Register
```

c5, Instruction Fault Status Register (IFSR)

The Instruction Fault Status Register, IFSR, holds status information about the last instruction fault.

The IFSR is:

- a 32-bit read/write register
- accessible only in privileged modes.

The format of the IFSR is:

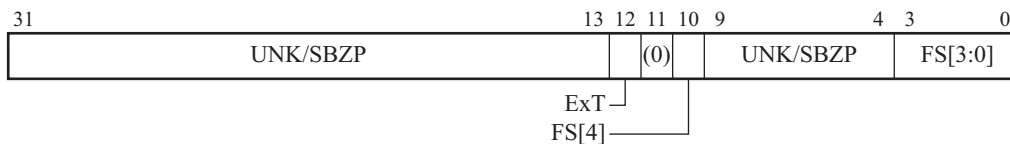

Bits [31:13,11,9:4]

UNK/SBZP.

ExT, bit [12] External abort type. This bit can be used to provide an IMPLEMENTATION DEFINED classification of external aborts.

For aborts other than external aborts this bit always returns 0.

FS, bits [10,3:0]

Fault status bits.

See Table B4-7 on page B4-20 for the valid encodings of these bits. All encodings not shown in the table are reserved.

For information about using the IFSR see *Fault Status and Fault Address registers in a PMSA implementation* on page B4-18.

Accessing the IFSR

To access the IFSR you read or write the CP15 registers with <opc1> set to 0, <CRn> set to c5, <CRm> set to c0, and <opc2> set to 1. For example:

```
MRC p15,0,<Rt>,c5,c0,1 ; Read CP15 Instruction Fault Status Register
MCR p15,0,<Rt>,c5,c0,1 ; Write CP15 Instruction Fault Status Register
```

c5, Auxiliary Data and Instruction Fault Status Registers (ADFSR and AIFSR)

The Auxiliary Data Fault Status Register (ADFSR) and the Auxiliary Instruction Fault Status Register (AIFSR) enable the system to return additional IMPLEMENTATION DEFINED fault status information, see *Auxiliary Fault Status Registers* on page B4-21.

The ADFSR and AIFSR are:

- 32-bit read/write registers
- accessible only in privileged modes
- introduced in ARMv7.

The formats of the ADFSR and AIFSR are IMPLEMENTATION DEFINED.

Accessing the ADFSR and AIFSR

To access the ADFSR or AIFSR you read or write the CP15 registers with <opc1> set to 0, <CRn> set to c5, <CRm> set to c1, and <opc2> set to:

- 0 for the ADFSR
- 1 for the AIFSR.

For example:

```
MRC p15,0,<Rt>,c5,c1,0 ; Read CP15 Auxiliary Data Fault Status Register
MCR p15,0,<Rt>,c5,c1,0 ; Write CP15 Auxiliary Data Fault Status Register
MRC p15,0,<Rt>,c5,c1,1 ; Read CP15 Auxiliary Instruction Fault Status Register
MCR p15,0,<Rt>,c5,c1,1 ; Write CP15 Auxiliary Instruction Fault Status Register
```

B4.6.23 CP15 c6, Fault Address registers

There are two Fault Address registers, in CP15 c6, as shown in Figure B4-7 on page B4-54. The two Fault Address registers complement the Fault Status registers, and are shown in Table B4-17.

Table B4-17 Fault address registers

Register name	Description
Data Fault Address Register (DFAR)	<i>c6, Data Fault Address Register (DFAR)</i>
Instruction Fault Address Register (IFAR)	<i>c6, Instruction Fault Address Register (IFAR) on page B4-58</i>

Note

Before ARMv7:

- The DFAR was called the Fault Address Register (FAR).
- The Watchpoint Fault Address Register (DBGWFAR) was implemented in CP15 c6 with <opc2> ==1. From ARMv7, the DBGWFAR is only implemented as a CP14 debug register, see *Watchpoint Fault Address Register (DBGWFAR)* on page C10-28.

Fault information is returned using the fault address registers and the fault status registers described in *CP15 c5, Fault status registers* on page B4-54. For details of how these registers are used see *Fault Status and Fault Address registers in a PMSA implementation* on page B4-18.

c6, Data Fault Address Register (DFAR)

The Data Fault Address Register, DFAR, holds the faulting address that caused a synchronous Data Abort exception.

The DFAR is:

- a 32-bit read/write register
- accessible only in privileged modes.

The format of the DFAR is:

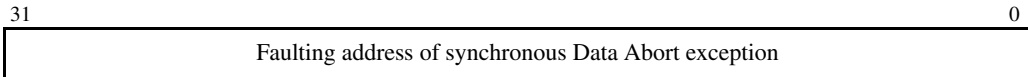

For information about using the DFAR, including when the value in the DFAR is valid, see *Fault Status and Fault Address registers in a PMSA implementation* on page B4-18.

A debugger can write to the DFAR to restore its value.

Accessing the DFAR

To access the DFAR you read or write the CP15 registers with <opc1> set to 0, <CRn> set to c6, <CRm> set to c0, and <opc2> set to 0. For example:

```
MRC p15,0,<Rt>,c6,c0,0 ; Read CP15 Data Fault Address Register
MCR p15,0,<Rt>,c6,c0,0 ; Write CP15 Data Fault Address Register
```

c6, Instruction Fault Address Register (IFAR)

The Instruction Fault Address Register, IFAR, holds the address of the faulting access that caused a synchronous Prefetch Abort exception.

The IFAR is:

- a 32-bit read/write register
- accessible only in privileged modes.

The format of the IFAR is:

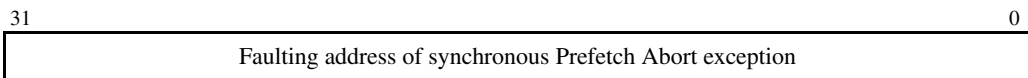

For information about using the IFAR, including when the value in the IFAR is valid, see *Fault Status and Fault Address registers in a PMSA implementation* on page B4-18.

A debugger can write to the IFAR to restore its value.

Accessing the IFAR

To access the IFAR you read or write the CP15 registers with <opc1> set to 0, <CRn> set to c6, <CRm> set to c0, and <opc2> set to 2. For example:

```
MRC p15,0,<Rt>,c6,c0,2 ; Read CP15 Instruction Fault Address Register
MCR p15,0,<Rt>,c6,c0,2 ; Write CP15 Instruction Fault Address Register
```

B4.6.24 CP15 c6, Memory region programming registers

When the PMSA is implemented, a number of registers in CP15 c6 are used to configure the MPU memory regions. There are three registers for each memory region supported by the MPU:

- A Base Address Register, that defined the start address of the region in the memory map.
- A Region Size and Enable Register, that:
 - has a single enable bit for the region
 - defines the size of the region
 - has a disable bit for each of the eight subregions in the region.
- A Region Access Control Register that defines the memory access attributes for the region.

The multiple copies of these registers are mapped onto three or six registers in CP15 c6, and another register is used to select the current memory region. The mapping of the region registers onto the CP15 registers depends on whether the MPU implements a unified memory map, or separate Instruction and Data memory maps:

Separate Instruction and Data memory maps

The multiple copies of the registers that describe each memory region map onto six CP15 registers.

For the memory regions in the Instruction memory map:

- the multiple Region Base Address Registers map onto the Instruction Region Base Address Register, IRBAR
- the multiple Region Size and Enable Registers map onto the Instruction Region Size and Enable Register, IRSR
- the multiple Region Access Control Registers map onto the Instruction Region Access Control Register, IRACR.

For the memory regions in the Data memory map:

- the multiple Region Base Address Registers map onto the Data Region Base Address Register, DRBAR
- the multiple Region Size and Enable Registers map onto the Data Region Size and Enable Register, DRSR
- the multiple Region Access Control Registers map onto the Data Region Access Control Register, DRACR.

The value in the RGNR is the index value for both the instruction region and the data region registers, see *c6, MPU Region Number Register (RGNR)* on page B4-66. The RGNR value indicates the current memory region for both the instruction and the data memory maps. However, a particular value might not be valid for both memory maps.

Unified memory maps

The multiple copies of the registers that describe each memory region map onto three CP15 registers:

- the multiple Region Base Address Registers map onto the Data Region Base Address Register, DRBAR

- the multiple Region Size and Enable Registers map onto the Data Region Size and Enable Register, DRSR
- the multiple Region Access Control Registers map onto the Data Region Access Control Register, DRACR.

The IRBAR, IRSR, and IRACR are not implemented.

The value in the RGNR is the index value for the data region registers, see *c6, MPU Region Number Register (RGNR)* on page B4-66. Its value indicates the current memory region in the unified memory map.

The read-only MPUIR indicates:

- whether the MPU implements separate Instruction and Data address maps, or a Unified address map
- the number of Data or Unified regions the MPU supports
- if separate Instruction and Data address maps are implemented, the number of Instruction regions the MPU supports.

For more information, see *c0, MPU Type Register (MPUIR)* on page B4-36.

Table B4-18 summarizes the CP15 registers that are used to program the MPU memory regions, and gives references to the full descriptions of these registers.

Table B4-18 MPU Memory Region Programming Registers

Register name	Description
Data or Unified Region Base Address	<i>c6, Data Region Base Address Register (DRBAR)</i>
Instruction Region Base Address ^a	<i>c6, Instruction Region Base Address Register (IRBAR)</i> on page B4-61 ^a
Data or Unified Region Size and Enable	<i>c6, Data Region Size and Enable Register (DRSR)</i> on page B4-62
Instruction Region Size and Enable ^a	<i>c6, Instruction Region Size and Enable Register (IRSR)</i> on page B4-63 ^a
Data or Unified Region Access Control	<i>c6, Data Region Access Control Register (DRACR)</i> on page B4-64
Instruction Region Access Control ^a	<i>c6, Instruction Region Access Control Register (IRACR)</i> on page B4-65 ^a
MPU Region Number	<i>c6, MPU Region Number Register (RGNR)</i> on page B4-66

- a. These registers are implemented only if the MPU implements separate Instruction and Data memory maps.

c6, Data Region Base Address Register (DRBAR)

The Data Region Base Address Register, DRBAR, indicates the base address of the current memory region in the data or unified address map. The base address must be aligned to the region size. The current memory region is selected by the value held in the RGNR, see *c6, MPU Region Number Register (RGNR)* on page B4-66.

The DRBAR is:

- a 32-bit read/write register
- accessible only in privileged modes.

The format of the DRBAR is:

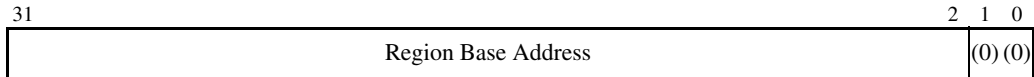

Region Base Address, bits [31:2]

The Base Address for the region, in the Data or Unified address map. The region referenced is selected by the RGNR

Bit [1:0] UNK/SBZP.

The DRBAR can be used to find the size of the supported physical address space for the Data or Unified memory map, see *Finding the minimum supported region size* on page B4-7.

Accessing the DRBAR

To access the DRBAR you read or write the CP15 registers with <opc1> set to 0, <CRn> set to c6, <CRm> set to c1, and <opc2> set to 0. For example:

```
MRC p15,0,<Rt>,c6,c1,0 ; Read CP15 Data Region Base Address Register
MCR p15,0,<Rt>,c6,c1,0 ; Write CP15 Data Region Base Address Register
```

c6, Instruction Region Base Address Register (IRBAR)

The Instruction Region Base Address Register, IRBAR, indicates the base address of the current memory region in the Instruction address map. The base address must be aligned to the region size. The current memory region is selected by the value held in the RGNR, see *c6, MPU Region Number Register (RGNR)* on page B4-66.

The IRBAR is:

- a 32-bit read/write register
- accessible only in privileged modes.
- implemented only when the PMSA implements separate instruction and data memory maps.

The format of the IRBAR is identical to the DRBAR, see *c6, Data Region Base Address Register (DRBAR)* on page B4-60.

The IRBAR can be used to find the minimum region size supported by the implementation, see *Finding the minimum supported region size* on page B4-7.

Accessing the IRBAR

To access the IRBAR you read or write the CP15 registers with <opc1> set to 0, <CRn> set to c6, <CRm> set to c1, and <opc2> set to 1. For example:

```
MRC p15,0,<Rt>,c6,c1,1 ; Read CP15 Instruction Region Base Address Register
MCR p15,0,<Rt>,c6,c1,1 ; Write CP15 Instruction Region Base Address Register
```

c6, Data Region Size and Enable Register (DRSR)

The Data Region Size and Enable Register, DRSR, indicates the size of the current memory region in the data or unified address map, and can be used to enable or disable:

- the entire region
- each of the eight subregions, if the region is enabled.

The current memory region is selected by the value held in the RGNR see *c6, MPU Region Number Register (RGNR)* on page B4-66.

The DRSR:

- is a 32-bit read/write register
- is accessible only in privileged modes.
- has a defined reset value of 0.

The format of the DRSR is:

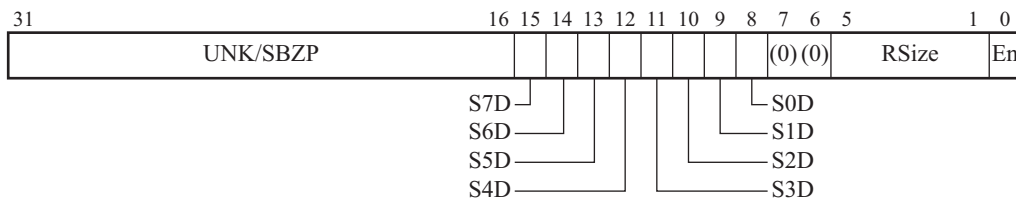

Bit [31:16,7:6]

UNK/SBZP.

SnD, bit [n+8], for values of n from 0 to 7

Subregion disable bit for region n. Indicates whether the subregion is part of this region:

- 0** Subregion is part of this region
- 1** Subregion disabled. The subregion is not part of this region.

The region is divided into exactly eight equal sized subregions. Subregion 0 is the subregion at the least significant address. For more information, see *Subregions* on page B4-3.

If the size of this region, indicated by the RSize field, is less than 256 bytes then the SnD fields are not defined, and register bits [15:8] are UNK/SBZP.

RSize, bits [5:1]

Region Size field. Indicates the size of the current memory region:

- A value of 0 is not permitted, this value is reserved and UNPREDICTABLE.
- If N is the value in this field, the region size is 2^{N+1} bytes.

En, bit [0] Enable bit for the region:

- 0** Region is disabled
1 Region is enabled.

Because this register resets to zero, all memory regions are disabled on reset.

All memory regions must be enabled before they are used.

The minimum region size supported is IMPLEMENTATION DEFINED, but if the memory system implementation includes a cache, ARM strongly recommends that the minimum region size is a multiple of the cache line length. This prevents cache attributes changing mid-way through a cache line.

Behavior is UNPREDICTABLE if you:

- write a region size that is outside the range supported by the implementation
- access this register when the RGNR does not point to a valid region in the MPU Data or Unified address map.

Accessing the DRSR

To access the DRSR you read or write the CP15 registers with <opc1> set to 0, <CRn> set to c6, <CRm> set to c1, and <opc2> set to 2. For example:

```
MRC p15,0,<Rt>,c6,c1,2    ; Read CP15 Data Region Size and Enable Register
MCR p15,0,<Rt>,c6,c1,2    ; Write CP15 Data Region Size and Enable Register
```

c6, Instruction Region Size and Enable Register (IRSR)

The Instruction Region Size and Enable Register, IRSR, indicates the size of the current memory region in the instruction address map, and to enable or disable:

- the entire region
- each of the eight subregions, if the region is enabled.

The current memory region is selected by the value held in the RGNR, see *c6, MPU Region Number Register (RGNR)* on page B4-66.

The IRSR:

- is a 32-bit read/write register
- is accessible only in privileged modes
- has a defined reset value of 0.
- is implemented only when the PMSA implements separate instruction and data memory maps.

The format of the IRSR is identical to the DRSR, see *c6, Data Region Size and Enable Register (DRSR)* on page B4-62.

All memory regions must be enabled before they are used.

The minimum region size supported is IMPLEMENTATION DEFINED, but if the memory system implementation includes an instruction cache, ARM strongly recommends that the minimum region size is a multiple of the instruction cache line length. This prevents cache attributes changing mid-way through a cache line.

Behavior is UNPREDICTABLE if you:

- write a region size that is outside the range supported by the implementation
- access this register when the RGNR does not point to a valid region in the MPU instruction address map.

Accessing the IRSR

To access the IRSR you read or write the CP15 registers with <opc1> set to 0, <CRn> set to c6, <CRm> set to c1, and <opc2> set to 3. For example:

```
MRC p15,0,<Rt>,c6,c1,3 ; Read CP15 Instruction Region Size and Enable Register
MCR p15,0,<Rt>,c6,c1,3 ; Write CP15 Instruction Region Size and Enable Register
```

c6, Data Region Access Control Register (DRACR)

The Data Region Access Control Register, DRACR, defines the memory attributes for the current memory region in the data or unified address map.

The current memory region is selected by the value held in the RGNR, see *c6, MPU Region Number Register (RGNR)* on page B4-66.

The DRACR is:

- a 32-bit read/write register
- accessible only in privileged modes.

The format of the DRACR is:

31	13	12	11	10	8	7	6	5	3	2	1	0					
UNK/SBZP										X N	(0)	AP [2:0]	(0) (0)	TEX [2:0]	S	C	B

Bit [31:13,11,7:6]

UNK/SBZP.

XN, bit [12] Execute Never bit. Indicates whether instructions can be fetched from this region:

- 0** region can contain executable code
- 1** region is an Execute never region, and any attempt to execute an instruction from the region results in a Permission fault.

If the MPU implements separate Instruction and Data memory maps this bit is [UNK/SBZ](#).
For more information, see *The Execute Never (XN) attribute and instruction prefetching* on page B4-10.

AP[2:0], bits [10:8]

Access Permissions field. Indicates the read and write access permissions for unprivileged and privileged accesses to the memory region.

For more information, see *Access permissions* on page B4-9.

TEX[2:0], C, B, bits [5:3,1:0]

Memory access attributes. For more information, see *C, B, and TEX[2:0] encodings* on page B4-11.

S, bit [2]

Shareable bit, for Normal memory regions:

- 0** If region is Normal memory, memory is Non-shareable
- 1** If region is Normal memory, memory is Shareable.

The value of this bit is ignored if the region is not Normal memory.

If you access this register when the RGNR does not point to a valid region in the MPU data or unified address map, the result is UNPREDICTABLE.

Accessing the DRACR

To access the DRACR you read or write the CP15 registers with <opc1> set to 0, <CRn> set to c6, <CRm> set to c1, and <opc2> set to 4. For example:

```
MRC p15,0,<Rt>,c6,c1,4    ; Read  CP15 Data Region Access Control Register
MCR p15,0,<Rt>,c6,c1,4    ; Write CP15 Data Region Access Control Register
```

c6, Instruction Region Access Control Register (IRACR)

The Instruction Region Access Control Register, IRACR, defines the memory attributes for the current memory region in the instruction address map, when the MPU implements separate data and instruction address maps.

The current memory region is selected by the value held in the RGNR, see *c6, MPU Region Number Register (RGNR)* on page B4-66.

The IRACR is:

- a 32-bit read/write register
- accessible only in privileged modes
- implemented only when the PMSA implements separate instruction and data memory maps.

The format of the IRACR is identical to the DRACR, see *c6, Data Region Access Control Register (DRACR)* on page B4-64.

Note

The XN bit, bit [12], is always valid in the IRACR.

If you access this register when the RGNR does not point to a valid region in the MPU instruction address map, the result is UNPREDICTABLE.

Accessing the IRACR

To access the IRACR you read or write the CP15 registers with <opc1> set to 0, <CRn> set to c6, <CRm> set to c1, and <opc2> set to 5. For example:

```
MRC p15,0,<Rt>,c6,c1,5 ; Read CP15 Instruction Region Access Control Register
MCR p15,0,<Rt>,c6,c1,5 ; Write CP15 Instruction Region Access Control Register
```

c6, MPU Region Number Register (RGNR)

The MPU Region Number Register, RGNR, defines the current memory region in:

- the MPU data or unified address map
- the MPU instruction address map, if the MPU implements separate data and instruction address maps.

The value in the RGNR identifies the memory region description accessed by the Region Base Address, Size and Enable, and Access Control Registers.

Note

There is only a single MPU Region Number Register. When the MPU implements separate data and instruction address maps, the current region number is always identical for both address maps. This might mean that the current region number is valid for one address map but invalid for the other map.

The RGNR is:

- a 32-bit read/write register
- accessible only in privileged modes.

The format of the RGNR is:

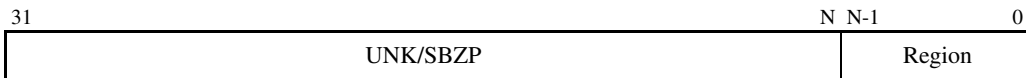

Bit [31:N] UNK/SBZP.

Region, bits [N-1:0]

The number of the current region in the Data or Unified address map, and in the Instruction address map if the MPU implements separate Data and Instruction address maps.

The value of N is $\text{Log}_2(\text{Number of regions supported})$ rounded up to an integer.

Memory region numbering starts at 0 and goes up to one less than the number of regions supported.

Writing a value to this register that is greater than or equal to the number of memory regions supported has UNPREDICTABLE results.

In the context of the RGNR description, when the MPU implements separate Data and Instruction address maps the Number of memory regions supported is the greater of:

- number of Data memory regions supported
- number of Instruction memory regions supported.

Accessing the RGNR

To access the RGNR you read or write the CP15 registers with <opc1> set to 0, <CRn> set to c6, <CRm> set to c2, and <opc2> set to 0. For example:

```
MRC p15,0,<Rt>,c6,c2,0 ; Read CP15 MPU Region Number Register
MCR p15,0,<Rt>,c6,c2,0 ; Write CP15 MPU Region Number Register
```

B4.6.25 CP15 c7, Cache maintenance and other functions

The CP15 c7 registers are used for cache maintenance operations, and also provide barrier operations. Figure B4-8 shows the CP15 c7 registers.

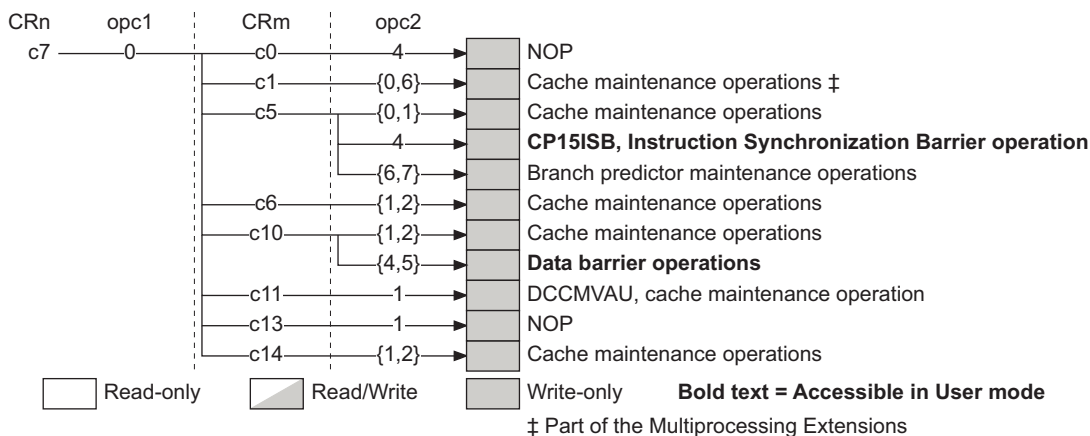

Figure B4-8 CP15 c7 registers in a PMSA implementation

All CP15 c7 encodings not shown in Figure B4-8 are UNPREDICTABLE, see *Unallocated CP15 encodings* on page B4-27.

The CP15 c7 operations are described in:

- *CP15 c7, Cache and branch predictor maintenance functions*
- *CP15 c7, Miscellaneous functions* on page B4-72.

B4.6.26 CP15 c7, Cache and branch predictor maintenance functions

CP15 c7 provides a number of functions. This section describes only the CP15 c7 cache and branch predictor maintenance operations. Branch predictor operations are included in this section, because they operate in a similar way to the cache maintenance operations.

————— Note —————

ARMv7 introduces significant changes in the CP15 c7 operations. Most of these changes are because, from ARMv7, the architecture covers multiple levels of cache. This section only describes the ARMv7 requirements for these operations. For details of these operations in previous versions of the architecture see:

- *c7, Cache operations* on page AppxG-38 for ARMv6
- *c7, Cache operations* on page AppxH-49 for ARMv4 and ARMv5.

Figure B4-9 shows the CP15 c7 cache and branch predictor maintenance operations.

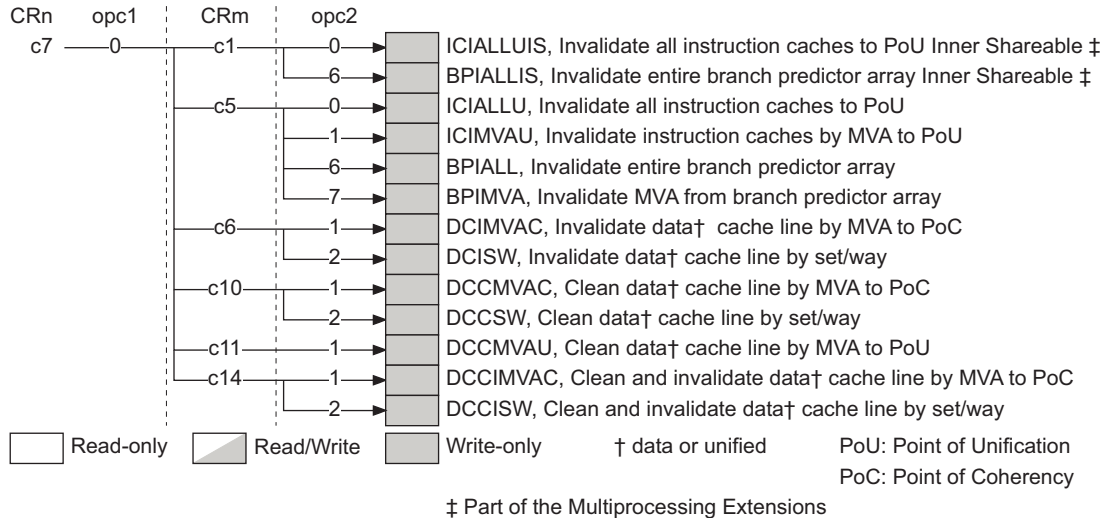

Figure B4-9 CP15 c7 Cache and branch predictor maintenance operations

The CP15 c7 cache and branch predictor maintenance operations are all write-only operations that can be executed only in privileged modes. They are listed in Table B4-19.

For more information about the terms used in this section see *Terms used in describing cache operations* on page B2-10. The Multiprocessing Extensions changes the set of caches affected by these operations, see *Multiprocessor effects on cache maintenance operations* on page B2-23.

In Table B4-19, the *Rt data* column specifies what data is required in the register *Rt* specified by the MCR instruction used to perform the operation. For more information about the possible data formats see *Data formats for the cache and branch predictor operations* on page B4-70.

Table B4-19 CP15 c7 cache and branch predictor maintenance operations

CRm	opc2	Mnemonic	Function ^a	Rt data
c1	0	ICIALLUIS	Invalidate all instruction caches to PoU Inner Shareable. Also flushes branch target cache. ^b	Ignored
c1	<u>1</u>	BPIALLIS	Invalidate entire branch predictor array Inner Shareable.	Ignored
c5	0	ICIALLU	Invalidate all instruction caches to PoU. Also flushes branch target cache. ^c	Ignored
c5	1	ICIMVAU	Invalidate instruction cache line by address to PoU. ^{b, d}	Address
c5	6	BPIALL	Invalidate entire branch predictor array.	Ignored

Table B4-19 CP15 c7 cache and branch predictor maintenance operations (continued)

CRm	opc2	Mnemonic	Function ^a	Rt data
c5	7	BPIMVA	Invalidate address from branch predictor array in the inner shareable domain. ^d	Address
c6	1	DCIMVAC	Invalidate data or unified cache line by address to PoU. ^d	Address
c6	2	DCISW	Invalidate data or unified cache line by set/way.	Set/way
c10	1	DCCMVAC	Clean data or unified cache line by address to PoC. ^d	Address
c10	2	DCCSW	Clean data or unified cache line by set/way.	Set/way
c11	1	DCCMVAU	Clean data or unified cache line by address to PoU. ^d	Address
c14	1	DCCIMVAC	Clean and invalidate data or unified cache line by address to PoC. ^d	Address
c14	2	DCCISW	Clean and invalidate data or unified cache line by set/way.	Set/way

- Address, *point of coherency* (PoC) and *point of unification* (PoU) are described in *Terms used in describing cache operations* on page B2-10.
- Only applies to separate instruction caches, does not apply to unified caches.
- Only applies to separate instruction caches, does not apply to unified caches.
- In general descriptions of the cache operations, these functions are described as operating by MVA (Modified Virtual Address). In a PMSA implementation the MVA and the PA have the same value, and so the functions operate using a physical address in the memory map.

Data formats for the cache and branch predictor operations

Table B4-19 on page B4-69 shows three possibilities for the data in the register Rt specified by the MCR instruction. These are described in the following subsections:

- *Ignored*
- *Address*
- *Set/way* on page B4-71

Ignored

The value in the register specified by the MCR instruction is ignored. You do not have to write a value to the register before issuing the MCR instruction.

Address

In general descriptions of the maintenance operations, operations that require a memory address are described as operating *by MVA*. For more information, see *Terms used in describing cache operations* on page B2-10. In a PMSA implementation, these operations require the physical address in the memory map. When the data is stated to be an address, it does not have to be cache line aligned.

Set/way

For an operation by set/way, the data identifies the cache line that the operation is to be applied to by specifying:

- the cache set the line belongs to
- the way number of the line in the set
- the cache level.

The format of the register data for a set/way operation is:

31	32-A	31-A	B	B-1	L	L-1	4	3	1	0
Way		SBZ		Set		SBZ		Level		0

Where:

A = $\text{Log}_2(\text{ASSOCIATIVITY})$

B = $(L + S)$

L = $\text{Log}_2(\text{LINELEN})$

S = $\text{Log}_2(\text{NSETS})$

ASSOCIATIVITY, LINELEN (Line Length) and NSETS (number of sets) have their usual meanings and are the values for the cache level being operated on.

The values of A and S are rounded up to the next integer.

Level ((Cache level to operate on) -1)

For example, this field is 0 for operations on L 1 cache, or 1 for operations on L 2 cache.

Set The number of the set to operate on.

Way The number of the way to operate on.

———— **Note** —————

- If L = 4 then there is no SBZ field between the set and level fields in the register.
- If A = 0 there is no way field in the register, and register bits [31:B] are SBZ.
- If the level, set or way field in the register is larger than the size implemented in the cache then the effect of the operation is UNPREDICTABLE.

Accessing the CP15 c7 cache maintenance operations

To perform one of the cache maintenance operations you write the CP15 registers with <opc1> set to 0, <CRn> set to c7, and <CRm> and <opc2> set to the values shown in Table B4-19 on page B4-69.

That is:

MCR p15,0,<Rt>,c7,<CRm>,<opc2>

For example:

MCR p15,0,<Rt>,c7,c5,0 ; Invalidate all instruction caches to point of unification

MCR p15,0,<Rt>,c7,c10,2 ; Clean data or unified cache line by set/way

B4.6.27 CP15 c7, Miscellaneous functions

CP15 c7 provides a number of functions, summarized in Figure B4-8 on page B4-68. This section describes only the CP15 c7 miscellaneous operations.

Figure B4-10 shows the CP15 c7 miscellaneous operations. It does not show the other CP15 c7 operations.

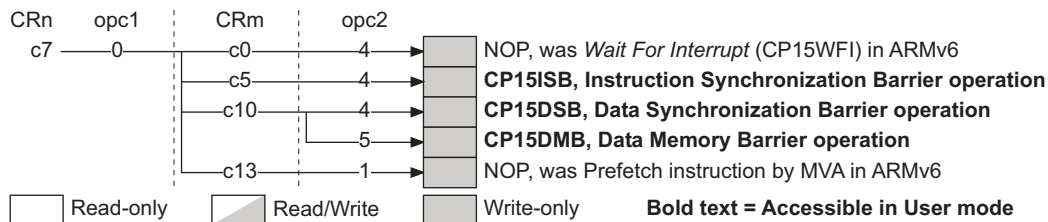

Figure B4-10 CP15 c7 Miscellaneous operations

The CP15 c7 miscellaneous operations are described in:

- *CP15 c7, Data and Instruction Barrier operations*
- *CP15 c7, No Operation (NOP)* on page B4-73.

CP15 c7, Data and Instruction Barrier operations

ARMv6 includes two CP15 c7 operations to perform Data Barrier operations, and another operation to perform an Instruction Barrier operation. In ARMv7:

- The ARM and Thumb instruction sets include instructions to perform the barrier operations, that can be executed in unprivileged and privileged modes, see *Memory barriers* on page A3-47.
- The CP15 c7 operations are defined as write-only operations, that can be executed in unprivileged and privileged modes, but using these operations is deprecated. The three operations are described in:
 - *Instruction Synchronization Barrier operation* on page B4-73
 - *Data Synchronization Barrier operation* on page B4-73
 - *Data Memory Barrier operation* on page B4-73.

The value in the register Rt specified by the MCR instruction used to perform one of these operations is ignored. You do not have to write a value to the register before issuing the MCR instruction.

In ARMv7 using these CP15 c7 operations is deprecated. Use the ISB, DSB, and DMB instructions instead.

Note

- In ARMv6 and earlier documentation, the Instruction Synchronization Barrier operation is referred to as a Prefetch Flush.
- In versions of the ARM architecture before ARMv6 the Data Synchronization Barrier operation is described as a *Data Write Barrier* (DWB).

Instruction Synchronization Barrier operation

In ARMv7, the ISB instruction is used to perform an Instruction Synchronization Barrier, see *ISB* on page A8-102.

The deprecated CP15 c7 encoding for an Instruction Synchronization Barrier is <opc1> set to 0, <CRn> set to c7, <CRm> set to c5, and <opc2> set to 4.

Data Synchronization Barrier operation

In ARMv7, the DSB instruction is used to perform a Data Synchronization Barrier, see *DSB* on page A8-92.

The deprecated CP15 c7 encoding for a Data Synchronization Barrier is <opc1> set to 0, <CRn> set to c7, <CRm> set to c10, and <opc2> set to 4. This operation performs the full system barrier performed by the DSB instruction.

Data Memory Barrier operation

In ARMv7, the DMB instruction is used to perform a Data Memory Barrier, see *DMB* on page A8-90.

The deprecated CP15 c7 encoding for a Data Memory Barrier is <opc1> set to 0, <CRn> set to c7, <CRm> set to c10, and <opc2> set to 5. This operation performs the full system barrier performed by the DMB instruction.

CP15 c7, No Operation (NOP)

ARMv6 includes two CP15 c7 operations that are not supported in ARMv7, with encodings that become *No Operation* (NOP) in ARMv7. These are:

- The *Wait For Interrupt* (CP15WFI) operation. In ARMv7 this operation is performed by the WFI instruction, that is available in the ARM and Thumb instruction sets. For more information, see *WFI* on page A8-810.
- The prefetch instruction by MVA operation. In ARMv7 this operation is replaced by the PLI instruction, that is available in the ARM and Thumb instruction sets. For more information, see *PLI (immediate, literal)* on page A8-242, and *PLI (register)* on page A8-244.

In ARMv7, the CP15 c7 encodings that were used for these operations must be valid write-only operations that perform a NOP. These encodings are:

- for the ARMv6 CP15WFI operation:
 - <opc1> set to 0, <CRn> set to c7, <CRm> set to c0, and <opc2> set to 4
- for the ARMv6 prefetch instruction by MVA operation:
 - <opc1> set to 0, <CRn> set to c7, <CRm> set to c13, and <opc2> set to 1.

B4.6.28 CP15 c8, Not used on a PMSA implementation

CP15 c8 is not used on an ARMv7-R implementation, see *Unallocated CP15 encodings* on page B4-27.

B4.6.29 CP15 c9, Cache and TCM lockdown registers and performance monitors

Some CP15 c9 register encodings are reserved for IMPLEMENTATION DEFINED memory system functions, in particular:

- cache control, including lockdown
- TCM control, including lockdown
- branch predictor control.

Additional CP15 c9 encodings are reserved for performance monitors. These encodings fall into two groups:

- the optional performance monitors described in Chapter C9 *Performance Monitors*
- additional IMPLEMENTATION DEFINED performance monitors.

The reserved encodings permit implementations that are compatible with previous versions of the ARM architecture, in particular with the ARMv6 requirements. Figure B4-11 shows the permitted CP15 c9 register encodings.

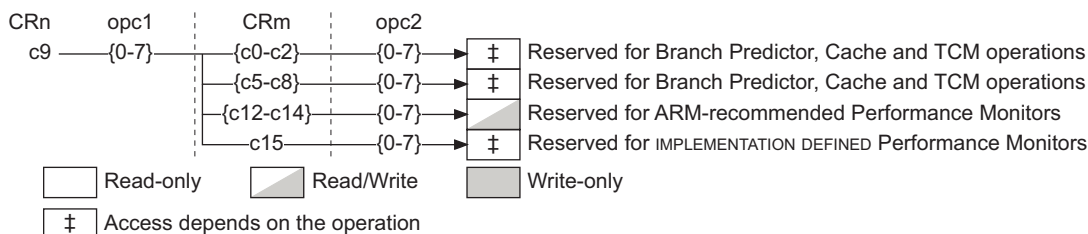

Figure B4-11 Permitted CP15 c9 register encodings

All CP15 c9 encodings not shown in Figure B4-11 are UNPREDICTABLE, see *Unallocated CP15 encodings* on page B4-27.

In ARMv6, CP15 c9 provides cache lockdown functions. With the ARMv7 abstraction of the hierarchical memory model, for CP15 c9:

- All encodings with CRm = {c0-c2, c5-c8} are reserved for IMPLEMENTATION DEFINED cache, branch predictor and TCM operations.
This reservation enables the implementation of a scheme that is backwards compatible with ARMv6. For details of the ARMv6 implementation see *c9, Cache lockdown support* on page AppxG-45.
- All encodings with CRm = {c12-c14} are reserved for the optional performance monitors that are defined in Chapter C9 *Performance Monitors*.
- All encodings with CRm = c15 are reserved for IMPLEMENTATION DEFINED performance monitoring features.

B4.6.30 CP15 c10, Not used on a PMSA implementation

CP15 c10 is not used on an ARMv7-R implementation, see *Unallocated CP15 encodings* on page B4-27.

B4.6.34 c13, Context ID Register (CONTEXTIDR)

The Context ID Register, CONTEXTIDR, identifies the current context by means of a *Context Identifier* (Context ID).

———— **Note** ————

Previously, on PMSA implementations, this Context ID has been described as a *Process Identifier* (PROCID), and this CP15 c13 register has been called the *Process ID Register*. The new naming makes the register naming consistent for PMSA and VMSA implementations.

The whole of this register is used by:

- the debug logic, for Linked and Unlinked Context ID matching, see *Breakpoint debug events* on page C3-5 and *Watchpoint debug events* on page C3-15.
- the trace logic, to identify the current process.

The CONTEXTIDR is:

- a 32-bit read/write register
- accessible only in privileged modes.

The format of the CONTEXTIDR is:

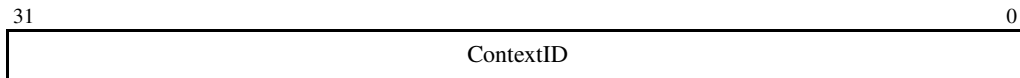
**ContextID, bits [31:0]**

Context Identifier. This field must be programmed with a unique context identifier value that identifies the current process. It is used by the trace logic and the debug logic to identify the process that is running currently.

Accessing the CONTEXTIDR

To access the CONTEXTIDR you read or write the CP15 registers with <opc1> set to 0, <CRn> set to c13, <CRm> set to c0, and <opc2> set to 1. For example:

```
MRC p15,0,<Rt>,c13,c0,1 ; Read CP15 Context ID Register
MCR p15,0,<Rt>,c13,c0,1 ; Write CP15 Context ID Register
```

B4.6.35 CP15 c13 Software Thread ID registers

The Software Thread ID registers provide locations where software can store thread identifying information, for OS management purposes. These registers are never updated by the hardware.

The Software Thread ID registers are:

- three 32-bit register read/write registers:
 - User Read/Write Thread ID Register, TPIDRURW
 - User Read-only Thread ID Register, TPIDRURO
 - Privileged Only Thread ID Register, TPIDRPRW.
- accessible in different modes:
 - the User Read/Write Thread ID Register is read/write in unprivileged and privileged modes
 - the User Read-only Thread ID Register is read-only in User mode, and read/write in privileged modes
 - the Privileged Only Thread ID Register is only accessible in privileged modes, and is read/write
- introduced in ARMv7.

Accessing the Software Thread ID registers

To access the Software Thread ID registers you read or write the CP15 registers with <opc1> set to 0, <CRn> set to c13, <CRm> set to c0, and <opc2> set to:

- 2 for the User Read/Write Thread ID Register, TPIDRURW
- 3 for the User Read-only Thread ID Register, TPIDRURO
- 4 for the Privileged Only Thread ID Register, TPIDRPRW.

For example:

```
MRC p15, 0, <Rt>, c13, c0, 2 ; Read CP15 User Read/Write Thread ID Register
MCR p15, 0, <Rt>, c13, c0, 2 ; Write CP15 User Read/Write Thread ID Register
MRC p15, 0, <Rt>, c13, c0, 3 ; Read CP15 User Read-only Thread ID Register
MCR p15, 0, <Rt>, c13, c0, 3 ; Write CP15 User Read-only Thread ID Register
MRC p15, 0, <Rt>, c13, c0, 4 ; Read CP15 Privileged Only Thread ID Register
MCR p15, 0, <Rt>, c13, c0, 4 ; Write CP15 Privileged Only Thread ID Register
```

B4.6.36 CP15 c14, Not used

CP15 c14 is not used on any ARMv7 implementation, see *Unallocated CP15 encodings* on page B4-27.

B4.6.37 CP15 c15, IMPLEMENTATION DEFINED registers

CP15 c15 is reserved for IMPLEMENTATION DEFINED purposes. ARMv7 does not impose any restrictions on the use of the CP15 c15 encodings. The documentation of the ARMv7 implementation must describe fully any registers implemented in CP15 c15. Normally, for processor implementations by ARM, this information is included in the *Technical Reference Manual* for the processor.

Typically, CP15 c15 is used to provide test features, and any required configuration options that are not covered by this manual.

B4.7 Pseudocode details of PMSA memory system operations

This section contains pseudocode describing PMSA-specific memory operations. The following subsections describe the pseudocode functions:

- *Alignment fault*
- *Address translation*
- *Default memory map attributes* on page B4-81.

See also the pseudocode for general memory system operations in *Pseudocode details of general memory system operations* on page B2-29.

B4.7.1 Alignment fault

The following pseudocode describes the Alignment fault in a PMSA implementation:

```
// AlignmentFaultP()
// =====

AlignmentFaultP(bits(32) address, boolean iswrite)

    DataAbort(address, bits(4) UNKNOWN, boolean UNKNOWN, iswrite, DAbort_Alignment);
```

B4.7.2 Address translation

The following pseudocode describes address translation in a PMSA implementation:

```
// TranslateAddressP()
// =====

AddressDescriptor TranslateAddressP(bits(32) va, boolean ispriv, boolean iswrite)

    AddressDescriptor result;
    Permissions perms;

    // PMSA only does flat mapping and security domain is effectively IMPLEMENTATION DEFINED.
    result.paddress.physicaladdress = va;
    result.paddress.physicaladdressex = '00000000';
    IMPLEMENTATION_DEFINED setting of result.paddress.NS;

    if SCTL.R.M == 0 then // MPU is disabled

        result.memAttrs = DefaultMemoryAttributes(va);

    else // MPU is enabled

        // Scan through regions looking for matching ones. If found, the last
        // one matched is used.
        region_found = FALSE;

        for r=0 to MPUIR.DRegion-1
            size_enable = DRSR[r];
```

```
base_address = DRBAR[r];
access_control = DRACR[r];

if size_enable<0> == '1' then // Region is enabled
    lsbite = UInt(size_enable<5:1>) + 1;
    if lsbite < 2 then UNPREDICTABLE;

    if lsbite == 32 || va<31:lsbite> == base_address<31:lsbite> then
        if lsbite >= 8 then // can have subregions
            subregion = UInt(va<lsbite-1:lsbite-3>);
            hit = (size_enable<subregion+8> == '0');
        else
            hit = TRUE;

        if hit then
            texcb = access_control<5:3,1:0>;
            S = access_control<2>;
            perms.ap = access_control<10:8>;
            perms.xn = access_control<12>;
            region_found = TRUE;

// Generate the memory attributes, and also the permissions if no region found.
if region_found then
    result.memattrs = DefaultTEXDecode(texcb, S);
else
    if SCTL.R.BR == '0' || NOT(ispriv) then
        DataAbort(address, bits(4) UNKNOWN, boolean UNKNOWN, iswrite, DAbort_Background);
    else
        result.memattrs = DefaultMemoryAttributes(va);
        perms.ap = '011';
        perms.xn = if va<31:28> == '1111' then NOT(SCTL.R.V) else va<31>;

// Check the permissions.
CheckPermission(perms, VA, boolean UNKNOWN, bits(4) UNKNOWN, iswrite, ispriv);

return result;
```

B4.7.3 Default memory map attributes

The following pseudocode describes the default memory map attributes in a PMSA implementation:

```
// DefaultMemoryAttributes()
// =====

MemoryAttributes DefaultMemoryAttributes(bits(32) va)

MemoryAttributes memattrs;

case va<31:30> of
  when '00'
    if SCTL.R.C == '0' then
      memattrs.type = MemType_Normal;
      memattrs.innerattrs = '00'; // Non-cacheable
      memattrs.shareable = TRUE;
    else
      memattrs.type = MemType_Normal;
      memattrs.innerattrs = '01'; // Write-back write-allocate cacheable
      memattrs.shareable = FALSE;
  when '01'
    if SCTL.R.C == '0' || va<29> == '1' then
      memattrs.type = MemType_Normal;
      memattrs.innerattrs = '00'; // Non-cacheable
      memattrs.shareable = TRUE;
    else
      memattrs.type = MemType_Normal;
      memattrs.innerattrs = '10'; // Write-through cacheable
      memattrs.shareable = FALSE;
  when '10'
    memattrs.type = MemType_Device;
    memattrs.innerattrs = '00'; // Non-cacheable
    memattrs.shareable = (va<29> == '1');
  when '11'
    memattrs.type = MemType_StronglyOrdered;
    memattrs.innerattrs = '00'; // Non-cacheable
    memattrs.shareable = TRUE;

// Outer attributes are the same as the inner attributes in all cases.
memattrs.outerattrs = memattrs.innerattrs;
memattrs.outershareable = memattrs.shareable;

return memattrs;
```

Chapter B5

The CPUID Identification Scheme

This chapter describes the CPUID scheme introduced as a requirement in ARMv7. This scheme provides registers that identify the architecture version and many features of the processor implementation. This chapter also describes the registers that identify the implemented Advanced SIMD and VFP features, if any.

This chapter contains the following sections:

- *Introduction to the CPUID scheme* on page B5-2
- *The CPUID registers* on page B5-4
- *Advanced SIMD and VFP feature identification registers* on page B5-34.

Note

The other chapters of this manual describe the permitted combinations of architectural features for the ARMv7-A and ARMv7-R architecture profiles, and some of the appendices give this information for previous versions of the architecture. Typically, permitted features are associated with a named architecture version, or version and profile, such as ARMv7-A or ARMv6.

The CPUID scheme is a mechanism for describing these permitted combinations in a way that enables software to determine the capabilities of the hardware it is running on.

The CPUID scheme does not extend the permitted combinations of architectural features beyond those associated with named architecture versions and profiles. The fact that the CPUID scheme can describe other combinations does not imply that those combinations are permitted ARM architecture variants.

B5.1 Introduction to the CPUID scheme

In ARM architecture versions before ARMv7, the architecture version is indicated by the Architecture field in the Main ID Register, see:

- *c0, Main ID Register (MIDR)* on page B3-81, for a VMSA implementation
- *c0, Main ID Register (MIDR)* on page B4-32, for a PMSA implementation.

From ARMv7, the architecture implements an extended processor identification scheme, using a number of registers in CP15 c0. ARMv7 requires the use of this scheme, and use of the scheme is indicated by a value of 0xF in the Architecture field of the Main ID Register.

Note

Some ARMv6 processors implemented the scheme before its formal adoption in the architecture.

The CPUID scheme provides information about the implemented:

- processor features
- debug features
- auxiliary features, in particular IMPLEMENTATION DEFINED features
- memory model features
- instruction set features.

The following sections give more information about the CPUID registers:

- *Organization of the CPUID registers*
- *General features of the CPUID registers* on page B5-3.

The CPUID registers on page B5-4 gives detailed descriptions of the registers.

This chapter also describes the identification registers for any Advanced SIMD or VFP implementation. These are registers in the shared register space for the Advanced SIMD and VFP extensions, in CP 10 and CP 11. *Advanced SIMD and VFP feature identification registers* on page B5-34 describes these registers.

B5.1.1 Organization of the CPUID registers

Figure B5-1 on page B5-3 shows the CPUID registers and their encodings in CP15. Two of the encodings shown, with <CRm> == c2 and <opc2> == {6,7}, are reserved for future expansion of the CPUID scheme. In addition, all CP15 c0 encodings with <CRm> == {c3-c7} and <opc2> == {0-7} are reserved for future expansion of the scheme. These reserved encodings must be RAZ.

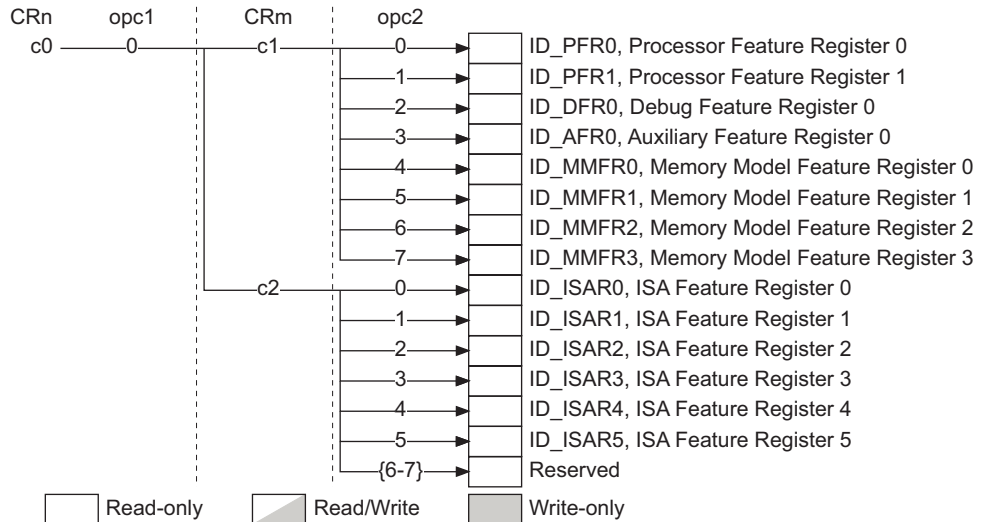

Figure B5-1 The CPUID register encodings

B5.1.2 General features of the CPUID registers

All of the CPUID registers are:

- 32-bit read-only registers
- accessible only in privileged modes
- when the Security Extensions are implemented, Common registers, see *Common CP15 registers* on page B3-74.

Each register is divided into eight 4-bit fields, and the possible field values are defined individually for each field. Some registers do not use all of these fields.

B5.2 The CPUID registers

The CPUID registers are described in detail in the following sections:

- *CP15 c0, Processor Feature registers*
- *c0, Debug Feature Register 0 (ID_DFR0)* on page B5-6
- *c0, Auxiliary Feature Register 0 (ID_AFR0)* on page B5-8
- *CP15 c0, Memory Model Feature registers* on page B5-9
- *CP15 c0, Instruction Set Attribute registers* on page B5-19.

See also *General features of the CPUID registers* on page B5-3.

B5.2.1 CP15 c0, Processor Feature registers

The Processor Feature registers, ID_PFR0 and ID_PFR1, provide information about the instruction set state support and programmers' model for the processor. There are two Processor Feature registers, described in:

- *c0, Processor Feature Register 0 (ID_PFR0)*
- *c0, Processor Feature Register 1 (ID_PFR1)* on page B5-5
- *Accessing the Processor Feature registers* on page B5-6.

c0, Processor Feature Register 0 (ID_PFR0)

The format of ID_PFR0 is:

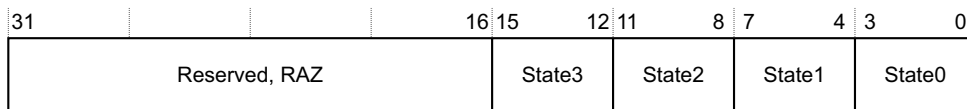

Bits [31:16] Reserved, RAZ.

State3, bits [15:12]

ThumbEE instruction set support. Permitted values are:

0b0000 Not supported.

0b0001 ThumbEE instruction set supported.

The value of 0b0001 is only permitted when State1 == 0b0011.

State2, bits [11:8]

Jazelle extension support. Permitted values are:

0b0000 Not supported.

0b0001 Support for Jazelle extension, without clearing of JOSCR.CV on exception entry.

0b0010 Support for Jazelle extension, with clearing of JOSCR.CV on exception entry.

State1, bits [7:4]

Thumb instruction set support. Permitted values are:

- 0b0000** No support for Thumb instruction set.
- 0b0001** Support for Thumb encoding before the introduction of Thumb-2 technology:
 - all instructions are 16-bit
 - a BL or BLX is a pair of 16-bit instructions
 - 32-bit instructions other than BL and BLX cannot be encoded.
- 0b0010** Reserved.
- 0b0011** Support for Thumb encoding after the introduction of Thumb-2 technology, and for all 16-bit and 32-bit Thumb basic instructions.

State0, bits [3:0]

ARM instruction set support. Permitted values are:

- 0b0000** No support for ARM instruction set.
- 0b0001** Support for ARM instruction set.

c0, Processor Feature Register 1 (ID_PFR1)

The format of ID_PFR1 is:

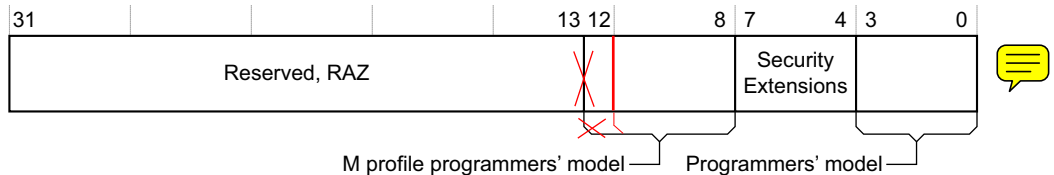

Bits [31:12] Reserved, RAZ.

M profile programmers' model, bits [11:8]

Permitted values are:

- 0b0000** Not supported.
- 0b0010** Support for two-stack programmers' model.

The value of 0b0001 is reserved.

Security Extensions, bits [7:4]

Permitted values are:

- 0b0000** Not supported.
- 0b0001** Support for the Security Extensions.
 - This includes support for Monitor mode and the SMC instruction.
- 0b0010** As for 0b0001, and adds the ability to set the NSACR.RFR bit.

Programmers' model, bits [3:0]

Support for the standard programmers' model for ARMv4 and later. Model must support User, FIQ, IRQ, Supervisor, Abort, Undefined and System modes. Permitted values are:

- 0b0000** Not supported.
- 0b0001** Supported.

Accessing the Processor Feature registers

To access the Processor Feature Registers you read the CP15 registers with <opc1> set to 0, <CRn> set to c0, <CRm> set to c1, and <opc2> set to:

- 0 for ID_PFR0
- 1 for ID_PFR1.

For example:

MRC p15, 0, <Rt>, c0, c1, 0 ; Read Processor Feature Register 0

B5.2.2 c0, Debug Feature Register 0 (ID_DFR0)

The Debug Feature Register 0, ID_DFR0, provides top level information about the debug system for the processor. You can obtain more information from the debug infrastructure, see *Debug identification registers* on page C10-3.

The format of the ID_DFR0 is:

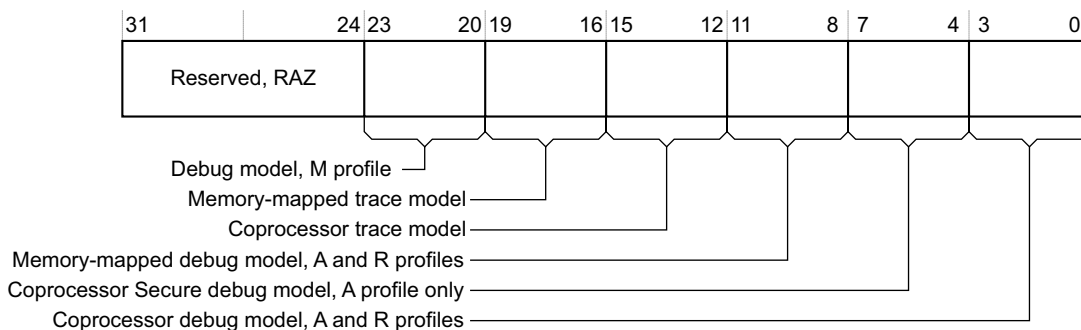

Bits [31:24] Reserved, RAZ.

Debug model, M profile, bits [23:20]

Support for memory-mapped debug model for M profile processors. Permitted values are:

- 0b0000** Not supported.
- 0b0001** Support for M profile Debug architecture, with memory-mapped access.

Memory-mapped trace model, bits [19:16]

Support for memory-mapped trace model. Permitted values are:

- 0b0000** Not supported.
- 0b0001** Support for ARM trace architecture, with memory-mapped access. The ID register, register `0x079`, gives more information about the implementation. See also *Trace* on page C1-5.

Coprocessor trace model, bits [15:12]

Support for coprocessor-based trace model. Permitted values are:

- 0b0000** Not supported.
- 0b0001** Support for ARM trace architecture, with CP14 access. The ID register, register `0x079`, gives more information about the implementation. See also *Trace* on page C1-5.

Memory-mapped debug model, A and R profiles, bits [11:8]

Support for memory-mapped debug model, for A and R profile processors. Permitted values are:

- 0b0000** Not supported, or pre-ARMv6 implementation.
- 0b0100** Support for v7 Debug architecture, with memory-mapped access.

Values 0b0001, 0b0010, and 0b0011 are reserved.

Coprocessor Secure debug model, bits [7:4]

Support for coprocessor-based Secure debug model, for an A profile processor that includes the Security Extensions. Permitted values are:

- 0b0000** Not supported.
- 0b0011** Support for v6.1 Debug architecture, with CP14 access.
- 0b0100** Support for v7 Debug architecture, with CP14 access.

Values 0b0001 and 0b0010 are reserved.

Coprocessor debug model, bits [3:0]

Support for coprocessor based debug model, for A and R profile processors. Permitted values are:

- 0b0000** Not supported.
- 0b0010** Support for v6 Debug architecture, with CP14 access.
- 0b0011** Support for v6.1 Debug architecture, with CP14 access.
- 0b0100** Support for v7 Debug architecture, with CP14 access.

Value 0b0001 is reserved.

Accessing the ID_DFR0

To access the ID_DFR0 you read the CP15 registers with <opc1> set to 0, <CRn> set to c0, <CRm> set to c1, and <opc2> set to 2. For example:

MRC p15, 0, <Rt>, c0, c1, 2 ; Read Debug Feature Register 0

B5.2.3 c0, Auxiliary Feature Register 0 (ID_AFR0)

The Auxiliary Feature Register 0, ID_AFR0, provides information about the IMPLEMENTATION DEFINED features of the processor.

The format of the ID_AFR0 is:

31					16	15		12	11		8	7		4	3	0
Reserved, RAZ					IMP		IMP		IMP		IMP		IMP			

Bits [31:16] Reserved, RAZ.

IMPLEMENTATION DEFINED, bits [15:12]

IMPLEMENTATION DEFINED, bits [11:8]

IMPLEMENTATION DEFINED, bits [7:4]

IMPLEMENTATION DEFINED, bits [3:0]

The Auxiliary Feature Register 0 has four 4-bit IMPLEMENTATION FIELDS. These fields are defined by the implementer of the design. The implementer is identified by the Implementer field of the Main ID Register, see:

- *c0, Main ID Register (MIDR)* on page B3-81, for a VMSA implementation
- *c0, Main ID Register (MIDR)* on page B4-32, for a PMSA implementation.

The Auxiliary Feature Register 0 enables implementers to include additional design features in the CPUID scheme. Field definitions for the Auxiliary Feature Register 0 might:

- differ between different implementers
- be subject to change
- migrate over time, for example if they are incorporated into the main architecture.

Accessing the ID_AFR0

To access the ID_AFR0 you read the CP15 registers with <opc1> set to 0, <CRn> set to c0, <CRm> set to c1, and <opc2> set to 3. For example:

MRC p15, 0, <Rt>, c0, c1, 3 ; Read Auxiliary Feature Register 0

B5.2.4 CP15 c0, Memory Model Feature registers

The Memory Model Feature registers, ID_MMFR0 to ID_MMFR3, provide general information about the implemented memory model and memory management support, including the supported cache and TLB operations. There are four Memory Model Feature registers, described in:

- *c0, Memory Model Feature Register 0 (ID_MMFR0)*
- *c0, Memory Model Feature Register 1 (ID_MMFR1)* on page B5-11
- *c0, Memory Model Feature Register 2 (ID_MMFR2)* on page B5-14
- *c0, Memory Model Feature Register 3 (ID_MMFR3)* on page B5-17
- *Accessing the Memory Model Feature registers* on page B5-19.

c0, Memory Model Feature Register 0 (ID_MMFR0)

The format of the ID_MMFR0 is:

31	28	27	24	23	20	19	16	15	12	11	8	7	4	3	0
Innermost shareability	FCSE support		Auxiliary registers		TCM support		Shareability levels		Outermost shareability		PMSA support		VMSA support		

Innermost shareability, bits [31:28]

Indicates the innermost shareability domain implemented. Permitted values are:

- 0b0000** Implemented as Non-cacheable.
- 0b0001** Implemented with hardware coherency support.
- 0b1111** Shareability ignored.

This field is valid only if ~~more than one level of shareability is implemented~~, as indicated by the value of the Shareability levels field, bits [15:12].

When the Shareability level field is zero, this field is UNK.

FCSE support, bits [27:24]

Indicates whether the implementation includes the FCSE. Permitted values are:

- 0b0000** Not supported.
- 0b0001** Support for FCSE.

The value of 0b0001 is only permitted when the VMSA_support field has a value greater than 0b0010.

Auxiliary registers, bits [23:20]

Indicates support for Auxiliary registers. Permitted values are:

- 0b0000** None supported.
- 0b0001** Support for Auxiliary Control Register only.
- 0b0010** Support for Auxiliary Fault Status Registers (AIFSR and ADFSR) and Auxiliary Control Register.

TCM support, bits [19:16]

Indicates support for TCMs and associated DMAs. Permitted values are:

- 0b0000** Not supported.
- 0b0001** Support is IMPLEMENTATION DEFINED. ARMv7 requires this setting.
- 0b0010** Support for TCM only, ARMv6 implementation.
- 0b0011** Support for TCM and DMA, ARMv6 implementation.

————— Note —————

An ARMv7 implementation might include an ARMv6 model for TCM support. However, in ARMv7 this is an IMPLEMENTATION DEFINED option, and therefore it must be represented by the 0b0001 encoding in this field.

Shareability levels, bits [15:12]

Indicates the number of shareability levels implemented. Permitted values are:

- 0b0000** One level of shareability implemented.
- 0b0001** Two levels of shareability implemented.

Outermost shareability, bits [11:8]

Indicates the outermost shareability domain implemented. Permitted values are:

- 0b0000** Implemented as Non-cacheable.
- 0b0001** Implemented with hardware coherency support.
- 0b1111** Shareability ignored.

PMSA support, bits [7:4]

Indicates support for a PMSA. Permitted values are:

- 0b0000** Not supported.
- 0b0001** Support for IMPLEMENTATION DEFINED PMSA.
- 0b0010** Support for PMSAv6, with a Cache Type Register implemented.
- 0b0011** Support for PMSAv7, with support for memory subsections. ARMv7-R profile.

When the PMSA support field is set to a value other than 0b0000 the VMSA support field must be set to 0b0000.

VMSA support, bits [3:0]

Indicates support for a VMSA. Permitted values are:

- 0b0000** Not supported.
- 0b0001** Support for IMPLEMENTATION DEFINED VMSA.
- 0b0010** Support for VMSAv6, with Cache and TLB Type Registers implemented.
- 0b0011** Support for VMSAv7, with support for remapping and the access flag. ARMv7-A profile.

When the VMSA support field is set to a value other than 0b0000 the PMSA support field must be set to 0b0000.

c0, Memory Model Feature Register 1 (ID_MMFR1)

The format of the ID_MMFR1 is:

31	28	27	24	23	20	19	16	15	12	11	8	7	4	3	0
Branch Predictor	L1 cache Test and Clean		L1 unified cache	L1 Harvard cache	L1 unified cache s/w	L1 Harvard cache s/w	L1 unified cache VA	L1 Harvard cache VA							

Branch predictor, bits [31:28]

Indicates branch predictor management requirements. Permitted values are:

- 0b0000** No branch predictor, or no MMU present. Implies a fixed MPU configuration.
- 0b0001** Branch predictor requires flushing on:
 - enabling or disabling the MMU
 - writing new data to instruction locations
 - writing new mappings to the translation tables
 - any change to the TTBR0, TTBR1, or TTBCR registers
 - changes of FCSE ProcessID or ContextID.
- 0b0010** Branch predictor requires flushing on:
 - enabling or disabling the MMU
 - writing new data to instruction locations
 - writing new mappings to the translation tables
 - any change to the TTBR0, TTBR1, or TTBCR registers without a corresponding change to the FCSE ProcessID or ContextID.
- 0b0011** Branch predictor requires flushing only on:
 - writing new data to instruction locations.
- 0b0100** For execution correctness, branch predictor requires no flushing at any time.

Note

The branch predictor is described in some documentation as the Branch Target Buffer.

L1 cache Test and Clean, bits [27:24]

Indicates the supported Level 1 data cache test and clean operations, for Harvard or unified cache implementations. Permitted values are:

- 0b0000** None supported. This is the required setting for ARMv7.
- 0b0001** Supported Level 1 data cache test and clean operations are:
 - Test and clean data cache.
- 0b0010** As for 0b0001, and adds:
 - Test, clean, and invalidate data cache.

L1 unified cache, bits [23:20]

Indicates the supported entire Level 1 cache maintenance operations, for a unified cache implementation. Permitted values are:

- 0b0000** None supported. This is the required setting for ARMv7, because ARMv7 requires a hierarchical cache implementation.
- 0b0001** Supported entire Level 1 cache operations are:
 - Invalidate cache, including branch predictor if appropriate
 - Invalidate branch predictor, if appropriate.
- 0b0010** As for 0b0001, and adds:
 - Clean cache. Uses a recursive model, using the cache dirty status bit.
 - Clean and invalidate cache. Uses a recursive model, using the cache dirty status bit.

If this field is set to a value other than 0b0000 then the L1 Harvard cache field, bits [19:16], must be set to 0b0000.

L1 Harvard cache, bits [19:16]

Indicates the supported entire Level 1 cache maintenance operations, for a Harvard cache implementation. Permitted values are:

- 0b0000** None supported. This is the required setting for ARMv7, because ARMv7 requires a hierarchical cache implementation.
- 0b0001** Supported entire Level 1 cache operations are:
 - Invalidate instruction cache, including branch predictor if appropriate
 - Invalidate branch predictor, if appropriate.
- 0b0010** As for 0b0001, and adds:
 - Invalidate data cache
 - Invalidate data cache and instruction cache, including branch predictor if appropriate.
- 0b0011** As for 0b0010, and adds:
 - Clean data cache. Uses a recursive model, using the cache dirty status bit.
 - Clean and invalidate data cache. Uses a recursive model, using the cache dirty status bit.

If this field is set to a value other than 0b0000 then the L1 unified cache field, bits [23:20], must be set to 0b0000.

L1 unified cache s/w, bits [15:12]

Indicates the supported Level 1 cache line maintenance operations by set/way, for a unified cache implementation. Permitted values are:

- 0b0000** None supported. This is the required setting for ARMv7, because ARMv7 requires a hierarchical cache implementation.
- 0b0001** Supported Level 1 unified cache line maintenance operations by set/way are:
 - Clean cache line by set/way.

0b0010 As for 0b0001, and adds:

- Clean and invalidate cache line by set/way.

0b0011 As for 0b0010, and adds:

- Invalidate cache line by set/way.

If this field is set to a value other than 0b0000 then the L1 Harvard cache s/w field, bits [11:8], must be set to 0b0000.

L1 Harvard cache s/w, bits [11:8]

Indicates the supported Level 1 cache line maintenance operations by set/way, for a Harvard cache implementation. Permitted values are:

0b0000 None supported. This is the required setting for ARMv7, because ARMv7 requires a hierarchical cache implementation.

0b0001 Supported Level 1 Harvard cache line maintenance operations by set/way are:

- Clean data cache line by set/way
- Clean and invalidate data cache line by set/way.

0b0010 As for 0b0001, and adds:

- Invalidate data cache line by set/way.

0b0011 As for 0b0010, and adds:

- Invalidate instruction cache line by set/way.

If this field is set to a value other than 0b0000 then the L1 unified cache s/w field, bits [15:12], must be set to 0b0000.

L1 unified cache VA, bits [7:4]

Indicates the supported Level 1 cache line maintenance operations by MVA, for a unified cache implementation. Permitted values are:

0b0000 None supported. This is the required setting for ARMv7, because ARMv7 requires a hierarchical cache implementation.

0b0001 Supported Level 1 unified cache line maintenance operations by MVA are:

- Clean cache line by MVA
- Invalidate cache line by MVA
- Clean and invalidate cache line by MVA.

0b0010 As for 0b0001, and adds:

- Invalidate branch predictor by MVA, if branch predictor is implemented.

If this field is set to a value other than 0b0000 then the L1 Harvard cache VA field, bits [3:0], must be set to 0b0000.

L1 Harvard cache VA, bits [3:0]

Indicates the supported Level 1 cache line maintenance operations by MVA, for a Harvard cache implementation. Permitted values are:

0b0000 None supported. This is the required setting for ARMv7, because ARMv7 requires a hierarchical cache implementation.

- 0b0001** Supported Level 1 Harvard cache line maintenance operations by MVA are:
- Clean data cache line by MVA
 - Invalidate data cache line by MVA
 - Clean and invalidate data cache line by MVA
 - Clean instruction cache line by MVA.
- 0b0010** As for 0b0001, and adds:
- Invalidate branch predictor by MVA, if branch predictor is implemented.
- If this field is set to a value other than 0b0000 then the L1 unified cache VA field, bits [7:4], must be set to 0b0000.

c0, Memory Model Feature Register 2 (ID_MMFR2)

The format of the ID_MMFR2 is:

31	28	27	24	23	20	19	16	15	12	11	8	7	4	3	0
HW access flag		WFI stall		Mem barrier		Unified TLB		Harvard TLB		L1 Harvard range		L1 Harvard bg prefetch		L1 Harvard fg prefetch	

HW access flag, bits [31:28]

Indicates support for a Hardware access flag, as part of the VMSSAv7 implementation. Permitted values are:

- 0b0000** Not supported.
- 0b0001** Support for VMSSAv7 access flag, updated in hardware.
- On an ARMv7-R implementation this field must be 0b0000.

WFI stall, bits [27:24]

Indicates the support for Wait For Interrupt (WFI) stalling. Permitted values are:

- 0b0000** Not supported.
- 0b0001** Support for WFI stalling.

Mem barrier, bits [23:20]

Indicates the supported CP15 memory barrier operations:

- 0b0000** None supported.
- 0b0001** Supported CP15 Memory barrier operations are:
- Data Synchronization Barrier (DSB). In previous versions of the ARM architecture, DSB was named Data Write Barrier (DWB).
- 0b0010** As for 0b0001, and adds:
- Instruction Synchronization Barrier (ISB). In previous versions of the ARM architecture, the ISB operation was called Prefetch Flush.
 - Data Memory Barrier (DMB).

Unified TLB, bits [19:16]

Indicates the supported TLB maintenance operations, for a unified TLB implementation.

Permitted values are:

- 0b0000** Not supported.
- 0b0001** Supported unified TLB maintenance operations are:
 - Invalidate all entries in the TLB
 - Invalidate TLB entry by MVA.
- 0b0010** As for 0b0001, and adds:
 - Invalidate TLB entries by ASID match.
- 0b0011** As for 0b0010 and adds:
 - Invalidate TLB entries by MVA All ASID.

If this field is set to a value other than 0b0000 then the Harvard TLB field, bits [15:12], must be set to 0b0000.

Harvard TLB, bits [15:12]

Indicates the supported TLB maintenance operations, for a Harvard TLB implementation.

Permitted values are:

- 0b0000** Not supported.
- 0b0001** Supported Harvard TLB maintenance operations are:
 - Invalidate all entries in the ITLB and the DTLB.
This is a shared unified TLB operation.
 - Invalidate all ITLB entries.
 - Invalidate all DTLB entries.
 - Invalidate ITLB entry by MVA.
 - Invalidate DTLB entry by MVA.
- 0b0010** As for 0b0001, and adds:
 - Invalidate ITLB and DTLB entries by ASID match.
This is a shared unified TLB operation.
 - Invalidate ITLB entries by ASID match
 - Invalidate DTLB entries by ASID match.

If this field is set to a value other than 0b0000 then the Unified TLB field, bits [19:16], must be set to 0b0000.

L1 Harvard range, bits [11:8]

Indicates the supported Level 1 cache maintenance range operations, for a Harvard cache implementation. Permitted values are:

0b0000 Not supported.

0b0001 Supported Level 1 Harvard cache maintenance range operations are:

- Invalidate data cache range by VA
- Invalidate instruction cache range by VA
- Clean data cache range by VA
- Clean and invalidate data cache range by VA.

L1 Harvard bg prefetch, bits [7:4]

Indicates the supported Level 1 cache background prefetch operations, for a Harvard cache implementation. When supported, background prefetch operations are non-blocking operations. Permitted values are:

0b0000 Not supported.

0b0001 Supported Level 1 Harvard cache background prefetch operations are:

- Prefetch instruction cache range by VA
- Prefetch data cache range by VA.

L1 Harvard fg prefetch, bits [3:0]

Indicates the supported Level 1 cache foreground prefetch operations, for a Harvard cache implementation. When supported, foreground prefetch operations are blocking operations. Permitted values are:

0b0000 Not supported.

0b0001 Supported Level 1 Harvard cache foreground prefetch operations are:

- Prefetch instruction cache range by VA
- Prefetch data cache range by VA.

c0, Memory Model Feature Register 3 (ID_MMFR3)

The format of the ID_MMFR3 is:

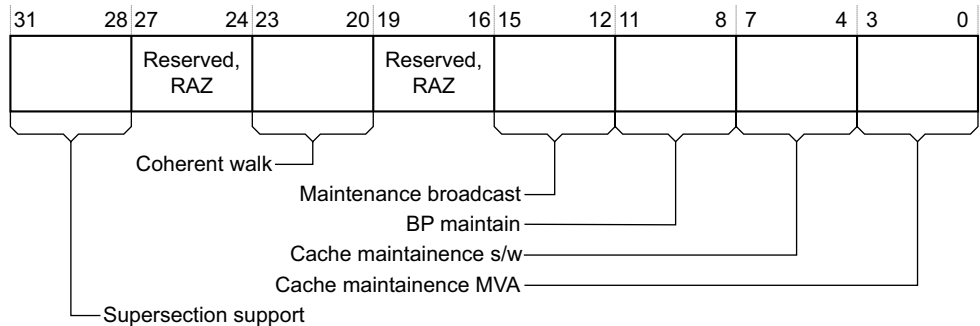
**Supersection support, bits [31:28]**

On a VMSA implementation, indicates whether Supersections are supported. Permitted values are:

0b0000 Supersections supported.

0b1111 Supersections not supported.

All other values are reserved.

———— Note ————

The sense of this identification is reversed from the normal usage in the CPUID mechanism, with the value of zero indicating that the feature is supported.

Bits [27:24] Reserved, RAZ.

Coherent walk, bits [23:20]

Indicates whether Translation table updates require a clean to the point of unification.

Permitted values are:

0b0000 Updates to the translation tables require a clean to the point of unification to ensure visibility by subsequent translation table walks.

0b0001 Updates to the translation tables do not require a clean to the point of unification to ensure visibility by subsequent translation table walks.

Bits [19:16] Reserved, RAZ.

Maintenance broadcast, bits [15:12]

Indicates whether Cache, TLB and branch predictor operations are broadcast. Permitted values are:

0b0000 Cache, TLB and branch predictor operations only affect local structures.

0b0001 Cache and branch predictor operations affect structures according to shareability and defined behavior of instructions. TLB operations only affect local structures.

0b0010 Cache, TLB and branch predictor operations affect structures according to shareability and defined behavior of instructions.

BP maintain, bits [11:8]

Indicates the supported branch predictor maintenance operations in an implementation with hierarchical cache maintenance operations. Permitted values are:

0b0000 None supported.

0b0001 Supported branch predictor maintenance operations are:

- Invalidate entire branch predictor array

0b0010 As for 0b0001, and adds:

- Invalidate branch predictor by MVA.

Cache maintain s/w, bits [7:4]

Indicates the supported cache maintenance operations by set/way, in an implementation with hierarchical caches. Permitted values are:

0b0000 None supported.

0b0001 Supported hierarchical cache maintenance operations by set/way are:

- Invalidate data cache by set/way
- Clean data cache by set/way
- Clean and invalidate data cache by set/way.

In a unified cache implementation, the data cache operations apply to the unified caches.

Cache maintain MVA, bits [3:0]

Indicates the supported cache maintenance operations by MVA, in an implementation with hierarchical caches. Permitted values are:

0b0000 None supported.

0b0001 Supported hierarchical cache maintenance operations by MVA are:

- Invalidate data cache by MVA
- Clean data cache by MVA
- Clean and invalidate data cache by MVA
- Invalidate instruction cache by MVA
- Invalidate all instruction cache entries.

In a unified cache implementation, the data cache operations apply to the unified caches, and the instruction cache operations are not implemented.

Accessing the Memory Model Feature registers

To access the Memory Model Feature Registers you read the CP15 registers with <opc1> set to 0, <CRn> set to c0, <CRm> set to c1, and <opc2> set to:

- 4 for the ID_MMFR0
- 5 for the ID_MMFR1
- 6 for the ID_MMFR2
- 7 for the ID_MMFR3.

For example:

```
MRC p15, 0, <Rt>, c0, c1, 6 ; Read Memory Model Feature Register 2
```

B5.2.5 CP15 c0, Instruction Set Attribute registers

The Instruction Set Attribute registers, ID_ISAR0 to ID_ISAR5, provide information about the instruction set supported by the processor. The instruction set is divided into:

- The basic instructions, for the ARM, Thumb, and ThumbEE instruction sets. If the Processor Feature Register 0 indicates support for one of these instruction sets then all basic instructions that have encodings in the corresponding instruction set must be implemented.
- The non-basic instructions. The Instruction Set Attribute registers indicate which of these instructions are implemented.

Instruction set descriptions in the CPUID scheme on page B5-20 describes the division of the instruction set into basic and non-basic instructions.

Summary of Instruction Set Attribute register attributes on page B5-22 lists all of the attributes and shows which register holds each attribute.

ARMv7 implements six Instruction Set Attribute registers, described in:

- *c0, Instruction Set Attribute Register 0 (ID_ISAR0)* on page B5-24
- *c0, Instruction Set Attribute Register 1 (ID_ISAR1)* on page B5-25
- *c0, Instruction Set Attribute Register 2 (ID_ISAR2)* on page B5-27
- *c0, Instruction Set Attribute Register 3 (ID_ISAR3)* on page B5-29
- *c0, Instruction Set Attribute Register 4 (ID_ISAR4)* on page B5-31
- *c0, Instruction Set Attribute Register 5 (ID_ISAR5)* on page B5-33
- *Accessing the Instruction Set Attribute registers* on page B5-33.

Instruction set descriptions in the CPUID scheme

The following subsections describe how the CPUID scheme describes the instruction set, and how instructions are classified as either basic or non-basic:

- *General rules for instruction classification*
- *Data-processing instructions*
- *Multiply instructions* on page B5-21
- *Branches* on page B5-21
- *Load or Store single word instructions* on page B5-21
- *Load or Store multiple word instructions* on page B5-21
- *Q flag support in the PSRs* on page B5-21.

General rules for instruction classification

Two general rules apply to the description of instruction classification given in this section:

1. The rules about an instruction being basic do not guarantee that it is available in any particular instruction set. For example, the rules given in this section classify `MOV R0, #123456789` as a basic instruction, but this instruction is not available in any existing ARM instruction set.
2. Whether an instruction is conditional or unconditional never makes any difference to whether it is a basic instruction.

Data-processing instructions

The data-processing instructions are:

ADC	ADD	AND	ASR	BIC	CMN	CMP	EOR	LSL	LSR	MOV	MVN
NEG	ORN	ORR	ROR	RRX	RSB	RSC	SBC	SUB	TEQ	TST	

An instruction from this group is a basic instruction if these conditions both apply:

- The second source operand, or the only source operand of a `MOV` or `MVN` instruction, is an immediate or an unshifted register.

———— **Note** —————

A `MOV` instruction with a shifted register source operand must be treated as the equivalent `ASR`, `LSL`, `LSR`, `ROR`, or `RRX` instruction, see *MOV (shifted register)* on page A8-198.

- The instruction is not one of the exception return instructions described in *SUBS PC, LR and related instructions* on page B6-25.

If either of these conditions does not apply then the instruction is a non-basic instruction. One or both of these attributes in the Instruction Set Attribute registers shows the support for non-basic data-processing instructions:

- `PSR_instrs`
- `WithShifts_instrs`.

Multiply instructions

The classification of multiply instructions is:

- MUL instructions are always basic instructions
- all other multiply instructions, and all multiply-accumulate instructions, are non-basic instructions.

Branches

All B and BL instructions are basic instructions.

Load or Store single word instructions

The instructions in this group are:

LDR LDRB LDRH LDRSB LDRSH STR STRB STRH

An instruction in this group is a basic instruction if its addressing mode is one of these forms:

- [Rn, #immediate]
- [Rn, #-immediate]
- [Rn, Rm]
- [Rn, -Rm].

A Load or Store single word instruction with any other addressing mode is a non-basic instruction. One or more of these attributes in the Instruction Set Attribute registers shows the support for these instructions:

- WithShifts_instrs
- Writeback_instrs
- Unpriv_instrs.

Load or Store multiple word instructions

The Load or Store multiple word instructions are:

LDM<mode> STM<mode> PUSH POP

A limited number of variants of these instructions are non-basic. The Except_instrs attribute in the Instruction Set Attribute registers shows the support for these instructions. For details of these non-basic instructions see *c0, Instruction Set Attribute Register 1 (ID_ISARI)* on page B5-25.

All other forms of these instructions are always basic instructions.

Q flag support in the PSRs

The Q flag is present in the CPSR and SPSRs when one or more of these conditions apply to the Instruction Set Attribute register attributes:

- MultS_instrs ≥ 2
- Saturate_instrs ≥ 1
- SIMD_instrs ≥ 1 .

Summary of Instruction Set Attribute register attributes

The Instruction Set Attribute registers use a set of attributes to indicate the non-basic instructions supported by the processor. The descriptions of the non-basic instructions in *Instruction set descriptions in the CPUID scheme* on page B5-20 include the attribute or attributes used to indicate support for each category of non-basic instructions. Table B5-1 lists all of these attributes in alphabetical order, and shows which Instruction Set Attribute register holds each attribute.

Table B5-1 Alphabetic list of Instruction Set Attribute registers attributes

Attribute	Register
Barrier_instrs	<i>c0, Instruction Set Attribute Register 4 (ID_ISAR4) on page B5-31</i>
BitCount_instrs	<i>c0, Instruction Set Attribute Register 0 (ID_ISAR0) on page B5-24</i>
Bitfield_instrs	<i>c0, Instruction Set Attribute Register 0 (ID_ISAR0) on page B5-24</i>
CmpBranch_instrs	<i>c0, Instruction Set Attribute Register 0 (ID_ISAR0) on page B5-24</i>
Coproc_instrs	<i>c0, Instruction Set Attribute Register 0 (ID_ISAR0) on page B5-24</i>
Debug_instrs	<i>c0, Instruction Set Attribute Register 0 (ID_ISAR0) on page B5-24</i>
Divide_instrs	<i>c0, Instruction Set Attribute Register 0 (ID_ISAR0) on page B5-24</i>
Endian_instrs	<i>c0, Instruction Set Attribute Register 1 (ID_ISAR1) on page B5-25</i>
Except_AR_instrs	<i>c0, Instruction Set Attribute Register 1 (ID_ISAR1) on page B5-25</i>
Except_instrs	<i>c0, Instruction Set Attribute Register 1 (ID_ISAR1) on page B5-25</i>
Extend_instrs	<i>c0, Instruction Set Attribute Register 1 (ID_ISAR1) on page B5-25</i>
IfThen_instrs	<i>c0, Instruction Set Attribute Register 1 (ID_ISAR1) on page B5-25</i>
Immediate_instrs	<i>c0, Instruction Set Attribute Register 1 (ID_ISAR1) on page B5-25</i>
Interwork_instrs	<i>c0, Instruction Set Attribute Register 1 (ID_ISAR1) on page B5-25</i>
Jazelle_instrs	<i>c0, Instruction Set Attribute Register 1 (ID_ISAR1) on page B5-25</i>
LoadStore_instrs	<i>c0, Instruction Set Attribute Register 2 (ID_ISAR2) on page B5-27</i>
MemHint_instrs	<i>c0, Instruction Set Attribute Register 2 (ID_ISAR2) on page B5-27</i>
Mult_instrs	<i>c0, Instruction Set Attribute Register 2 (ID_ISAR2) on page B5-27</i>
MultiAccessInt_instrs	<i>c0, Instruction Set Attribute Register 2 (ID_ISAR2) on page B5-27</i>
MultS_instrs	<i>c0, Instruction Set Attribute Register 2 (ID_ISAR2) on page B5-27</i>
MultU_instrs	<i>c0, Instruction Set Attribute Register 2 (ID_ISAR2) on page B5-27</i>

Table B5-1 Alphabetic list of Instruction Set Attribute registers attributes (continued)

Attribute	Register
PSR_AR_instrs	<i>c0, Instruction Set Attribute Register 2 (ID_ISAR2) on page B5-27</i>
PSR_M_instrs	<i>c0, Instruction Set Attribute Register 4 (ID_ISAR4) on page B5-31</i>
Reversal_instrs	<i>c0, Instruction Set Attribute Register 2 (ID_ISAR2) on page B5-27</i>
Saturate_instrs	<i>c0, Instruction Set Attribute Register 3 (ID_ISAR3) on page B5-29</i>
SIMD_instrs	<i>c0, Instruction Set Attribute Register 3 (ID_ISAR3) on page B5-29</i>
SMC_instrs	<i>c0, Instruction Set Attribute Register 4 (ID_ISAR4) on page B5-31</i>
SVC_instrs	<i>c0, Instruction Set Attribute Register 3 (ID_ISAR3) on page B5-29</i>
Swap_instrs	<i>c0, Instruction Set Attribute Register 0 (ID_ISAR0) on page B5-24</i>
SynchPrim_instrs	<i>c0, Instruction Set Attribute Register 3 (ID_ISAR3) on page B5-29</i>
SynchPrim_instrs_frac	<i>c0, Instruction Set Attribute Register 4 (ID_ISAR4) on page B5-31</i>
TabBranch_instrs	<i>c0, Instruction Set Attribute Register 3 (ID_ISAR3) on page B5-29</i>
ThumbCopy_instrs	<i>c0, Instruction Set Attribute Register 3 (ID_ISAR3) on page B5-29</i>
ThumbEE_extn_instrs	<i>c0, Instruction Set Attribute Register 3 (ID_ISAR3) on page B5-29</i>
TrueNOP_instrs	<i>c0, Instruction Set Attribute Register 3 (ID_ISAR3) on page B5-29</i>
Unpriv_instrs	<i>c0, Instruction Set Attribute Register 4 (ID_ISAR4) on page B5-31</i>
WithShifts_instrs	<i>c0, Instruction Set Attribute Register 4 (ID_ISAR4) on page B5-31</i>
Writeback_instrs	<i>c0, Instruction Set Attribute Register 4 (ID_ISAR4) on page B5-31</i>

c0, Instruction Set Attribute Register 0 (ID_ISAR0)

The format of the ID_ISAR0 is:

31	28	27	24	23	20	19	16	15	12	11	8	7	4	3	0
Reserved, RAZ		Divide _instrs		Debug _instrs		Coprocc _instrs		CmpBranch _instrs		Bitfield _instrs		BitCount _instrs		Swap _instrs	

Bits [31:28] Reserved, RAZ.

Divide_instrs, bits [27:24]

Indicates the supported Divide instructions. Permitted values are:

- 0b0000** . None supported.
- 0b0001** . Adds support for SDIV and UDIV.

Debug_instrs, bits [23:20]

Indicates the supported Debug instructions. Permitted values are:

- 0b0000** None supported.
- 0b0001** Adds support for BKPT.

Coprocc_instrs, bits [19:16]

Indicates the supported Coprocessor instructions. Permitted values are:

- 0b0000** None supported, except for separately attributed architectures including CP15, CP14, and Advanced SIMD and VFP.
- 0b0001** Adds support for generic CDP, LDC, MCR, MRC, and STC.
- 0b0010** As for 0b0001, and adds generic CDP2, LDC2, MCR2, MRC2, and STC2.
- 0b0011** As for 0b0010, and adds generic MCRR and MRRC.
- 0b0100** As for 0b0011, and adds generic MCRR2 and MRRC2.

CmpBranch_instrs, bits [15:12]

Indicates the supported combined Compare and Branch instructions in the Thumb instruction set. Permitted values are:

- 0b0000** None supported.
- 0b0001** Adds support for CBNZ and CBZ.

Bitfield_instrs, bits [11:8]

Indicates the supported BitField instructions. Permitted values are:

- 0b0000** None supported.
- 0b0001** Adds support for BFC, BFI, SBFX, and UBFX.

BitCount_instrs, bits [7:4]

Indicates the supported Bit Counting instructions. Permitted values are:

- 0b0000** None supported.
- 0b0001** Adds support for CLZ.

Swap_instrs, bits [3:0]

Indicates the supported Swap instructions in the ARM instruction set. Permitted values are:

- 0b0000** None supported.
- 0b0001** Adds support for SWP and SWPB.

c0, Instruction Set Attribute Register 1 (ID_ISAR1)

The format of the IID_ISAR1 is:

31	28	27	24	23	20	19	16	15	12	11	8	7	4	3	0
Jazelle _instrs	Interwork _instrs	Immediate _instrs	IfThen _instrs	Extend _instrs	Except_AR _instrs	Except _instrs	Endian _instrs								

Jazelle_instrs, bits [31:28]

Indicates the supported Jazelle extension instructions. Permitted values are:

- 0b0000** No support for Jazelle.
- 0b0001** Adds support for BXJ instruction, and the J bit in the PSR.
This setting might indicate a trivial implementation of Jazelle support.

Interwork_instrs, bits [27:24]

Indicates the supported Interworking instructions. Permitted values are:

- 0b0000** None supported.
- 0b0001** Adds support for BX instruction, and the T bit in the PSR.
- 0b0010** As for 0b0001, and adds support for BLX instruction. PC loads have BX-like behavior.
- 0b0011** As for 0b0010, but guarantees that data-processing instructions in the ARM instruction set with the PC as the destination and the S bit clear have BX-like behavior.

Note

A value of 0b0000, 0b0001, or 0b0010 in this field does not guarantee that an ARM data-processing instruction with the PC as the destination and the S bit clear behaves like an old MOV PC instruction, ignoring bits [1:0] of the result. With these values of this field:

- if bits [1:0] of the result value are 0b00 then the processor remains in ARM state
- if bits [1:0] are 0b01, 0b10 or 0b11, the result must be treated as UNPREDICTABLE.

Immediate_instrs, bits [23:20]

Indicates the support for data-processing instructions with long immediates. Permitted values are:

- 0b0000** None supported.

- 0b0001** Adds support for:
- the MOV_T instruction
 - the MOV instruction encodings with zero-extended 16-bit immediates
 - the Thumb ADD and SUB instruction encodings with zero-extended 12-bit immediates, and the other ADD, ADR and SUB encodings cross-referenced by the pseudocode for those encodings.

IfThen_instrs, bits [19:16]

Indicates the supported IfThen instructions in the Thumb instruction set. Permitted values are:

- 0b0000** None supported.
0b0001 Adds support for the IT instructions, and for the IT bits in the PSRs.

Extend_instrs, bits [15:12]

Indicates the supported Extend instructions. Permitted values are:

- 0b0000** No scalar sign-extend or zero-extend instructions are supported, where scalar instructions means non-Advanced SIMD instructions.
0b0001 Adds support for the SXTB, SXT_H, UXTB, and UXT_H instructions.
0b0010 As for 0b0001, and adds support for the SXTB16, SXTAB, SXTAB16, SXTA_H, UXTB16, UXTAB, UXTAB16, and UXTA_H instructions.

———— **Note** —————

In addition:

- the shift options on these instructions are available only if the WithShifts_instrs attribute is 0b0011 or greater
- the SXTAB16, SXTB16, UXTAB16, and UXTB16 instructions are available only if both:
 - the Extend_instrs attribute is 0b0010 or greater
 - the SIMD_instrs attribute is 0b0011 or greater.

Except_AR_instrs, bits [11:8]

Indicates the supported A and R profile exception-handling instructions. Permitted values are:

- 0b0000** None supported.
0b0001 Adds support for the SRS and RFE instructions, and the A and R profile forms of the CPS instruction.

Except_instrs, bits [7:4]

Indicates the supported exception-handling instructions in the ARM instruction set. Permitted values are:

- 0b0000** Not supported. This indicates that the User bank and Exception return forms of the LDM and STM instructions are not supported.
0b0001 Adds support for the LDM (exception return), LDM (user registers) and STM (user registers) instruction versions.

Endian_instrs, bits [3:0]

Indicates the supported Endian instructions. Permitted values are:

- 0b0000** None supported.
- 0b0001** Adds support for the SETEND instruction, and the E bit in the PSRs.

c0, Instruction Set Attribute Register 2 (ID_ISAR2)

The format of the ID_ISAR2 is:

31	28	27	24	23	20	19	16	15	12	11	8	7	4	3	0
Reversal _instrs	PSR_AR _instrs	MultU _instrs	MultS _instrs	Mult _instrs	MultiAccess Int_instrs	MemHint _instrs	LoadStore _instrs								

Reversal_instrs, bits [31:28]

Indicates the supported Reversal instructions. Permitted values are:

- 0b0000** None supported.
- 0b0001** Adds support for the REV, REV16, and REVSH instructions.
- 0b0010** As for 0b0001, and adds support for the RBIT instruction.

PSR_AR_instrs, bits [27:24]

Indicates the supported A and R profile instructions to manipulate the PSR. Permitted values are:

- 0b0000** None supported.
- 0b0001** Adds support for the MRS and MSR instructions, and the exception return forms of data-processing instructions described in *SUBS PC, LR and related instructions* on page B6-25.

———— **Note** —————

The exception return forms of the data-processing instructions are:

- In the ARM instruction set, data-processing instructions with the PC as the destination and the S bit set. These instructions might be affected by the WithShifts attribute.
- In the Thumb instruction set, the SUBS PC,LR,#N instruction.

MultU_instrs, bits [23:20]

Indicates the supported advanced unsigned Multiply instructions. Permitted values are:

- 0b0000** None supported.
- 0b0001** Adds support for the UMULL and UMLAL instructions.
- 0b0010** As for 0b0001, and adds support for the UMAAL instruction.

MultS_instrs, bits [19:16]

Indicates the supported advanced signed Multiply instructions. Permitted values are:

- 0b0000** None supported.
- 0b0001** Adds support for the SMULL and SMLAL instructions.
- 0b0010** As for 0b0001, and adds support for the SMLABB, SMLABT, SMLALBB, SMLALBT, SMLALTB, SMLALTT, SMLATB, SMLATT, SMLAWB, SMLAWT, SMULBB, SMULBT, SMULTB, SMULTT, SMULWB, and SMULWT instructions.
Also adds support for the Q bit in the PSRs.
- 0b0011** As for 0b0010, and adds support for the SMLAD, SMLADX, SMLALD, SMLALDX, SMLSD, SMLSDX, SMLSLD, SMLSLDX, SMMLA, SMMLAR, SMMLS, SMMLSR, SMMUL, SMMULR, SMUAD, SMUADX, SMUSD, and SMUSDX instructions.

Mult_instrs, bits [15:12]

Indicates the supported additional Multiply instructions. Permitted values are:

- 0b0000** No additional instructions supported. This means only MUL is supported.
- 0b0001** Adds support for the MLA instruction.
- 0b0010** As for 0b0001, and adds support for the MLS instruction.

MultiAccessInt_instrs, bits [11:8]

Indicates the support for multi-access interruptible instructions. Permitted values are:

- 0b0000** None supported. This means the LDM and STM instructions are not interruptible.
- 0b0001** LDM and STM instructions are restartable.
- 0b0010** LDM and STM instructions are continuable.

MemHint_instrs, bits [7:4]

Indicates the supported Memory Hint instructions. Permitted values are:

- 0b0000** None supported.
- 0b0001** Adds support for the PLD instruction.
- 0b0010** Adds support for the PLD instruction.
In the MemHint_instrs field, entries of 0b0001 and 0b0010 have identical meanings.
- 0b0011** As for 0b0001 (or 0b0010), and adds support for the PLI instruction.
- 0b0100** As for 0b0011, and adds support for the PLDW instruction.

LoadStore_instrs, bits [3:0]

Indicates the supported additional load/store instructions. Permitted values are:

- 0b0000** None supported.
- 0b0001** Adds support for the LDRD and STRD instructions.

c0, Instruction Set Attribute Register 3 (ID_ISAR3)

The format of the ID_ISAR3 is:

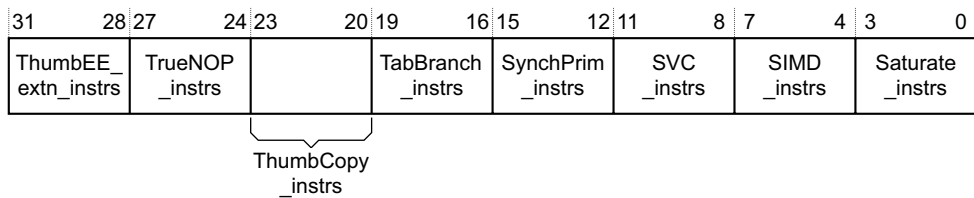
**ThumbEE_extn_instrs, bits [31:28]**

Indicates the supported Thumb Execution Environment (ThumbEE) extension instructions. Permitted values are:

- 0b0000** None supported.
- 0b0001** Adds support for the ENTERX and LEAVEX instructions, and modifies the load behavior to include null checking.

Note

This field can only have a value other than 0b0000 when the PFR0 register State3 field has a value of 0b0001, see *c0, Processor Feature Register 0 (ID_PFR0)* on page B5-4.

TrueNOP_instrs, bits [27:24]

Indicates the support for True NOP instructions. Permitted values are:

- 0b0000** None supported. This means there are no NOP instructions that do not have any register dependencies.
- 0b0001** Adds true NOP instructions in both the Thumb and ARM instruction sets. Also permits additional NOP-compatible hints.

ThumbCopy_instrs, bits [23:20]

Indicates the supported Thumb non flag-setting MOV instructions. Permitted values are:

- 0b0000** Not supported. This means that in the Thumb instruction set, encoding T1 of the MOV (register) instruction does not support a copy from a low register to a low register.
- 0b0001** Adds support for Thumb instruction set encoding T1 of the MOV (register) instruction, copying from a low register to a low register.

TabBranch_instrs, bits [19:16]

Indicates the supported Table Branch instructions in the Thumb instruction set. Permitted values are:

- 0b0000** None supported.
- 0b0001** Adds support for the TBB and TBH instructions.

SynchPrim_instrs, bits [15:12]

This field is used with the SynchPrim_instrs_frac field of ID_ISAR4 to indicate the supported Synchronization Primitive instructions. Table B5-2 shows the permitted values of these fields:

Table B5-2 Synchronization Primitives support

SynchPrim_instrs	SynchPrim_instrs_frac	Supported Synchronization Primitives
0000	0000	None supported
0001	0000	Adds support for the LDREX and STREX instructions.
0001	0011	As for [0001,0000], and adds support for the CLREX, LDREXB, LDREXH, STREXB, and STREXH instructions.
0010	0000	As for [0001,0011], and adds support for the LDREXD and STREXD instructions.

All combinations of SynchPrim_instrs and SynchPrim_instrs_frac not shown in Table B5-2 are reserved.

SVC_instrs, bits [11:8]

Indicates the supported SVC instructions. Permitted values are:

0b0000 Not supported.

0b0001 Adds support for the SVC instruction.

———— **Note** —————

The SVC instruction was called the SWI instruction in previous versions of the ARM architecture.

SIMD_instrs, bits [7:4]

Indicates the supported SIMD instructions. Permitted values are:

0b0000 None supported.

0b0001 Adds support for the SSAT and USAT instructions, and for the Q bit in the PSRs.

0b0011 As for 0b0001, and adds support for the PKHBT, PKHTB, QADD16, QADD8, QASX, QSUB16, QSUB8, QSAX, SADD16, SADD8, SASX, SEL, SHADD16, SHADD8, SHASX, SHSUB16, SHSUB8, SHSAX, SSAT16, SSUB16, SSUB8, SSAX, SXTAB16, SXTB16, UADD16, UADD8, UASX, UHADD16, UHADD8, UHASX, UHSUB16, UHSUB8, UHSAX, UQADD16, UQADD8, UQASX, UQSUB16, UQSUB8, UQSAX, USAD8, USADA8, USAT16, USUB16, USUB8, USAX, UXTAB16, and UXTB16 instructions.

Also adds support for the GE[3:0] bits in the PSRs.

Note

- in the SIMD_instrs field, the value of 0b0010 is reserved
- the SXTAB16, SXTB16, UXTAB16, and UXTB16 instructions are available only if both:
 - the Extend_instrs attribute is 0b0010 or greater
 - the SIMD_instrs attribute is 0b0011 or greater.

Saturate_instrs, bits [3:0]

Indicates the supported Saturate instructions. Permitted values are:

- 0b0000** None supported. This means no non-Advanced SIMD saturate instructions are supported.
- 0b0001** Adds support for the QADD, QDADD, QDSUB, and QSUB instructions, and for the Q bit in the PSRs.

c0, Instruction Set Attribute Register 4 (ID_ISAR4)

The format of the ID_ISAR4 is:

31	28	27	24	23	20	19	16	15	12	11	8	7	4	3	0
SWP_frac		PSR_M_instrs		SynchPrim_instrs_frac		Barrier_instrs		SMC_instrs		Writeback_instrs		WithShifts_instrs		Unpriv_instrs	

SWP_frac, bits [31:28]

Indicates support for the memory system locking the bus for SWP or SWPB instructions. Permitted values are:

- 0b0000** SWP or SWPB not supported.
- 0b0001** SWP or SWPB supported but only in a uniprocessor context. SWP and SWPB do not guarantee whether memory accesses from other masters can come between the load memory access and the store memory access of the SWP or SWPB.

This field is valid only if the Swap_instrs field in ID_ISAR0 is zero.

PSR_M_instrs, bits [27:24]

Indicates the supported M profile instructions to modify the PSRs. Permitted values are:

- 0b0000** None supported.
- 0b0001** Adds support for the M profile forms of the CPS, MRS and MSR instructions.

SynchPrim_instrs_frac, bits [23:20]

This field is used with the SynchPrim_instrs field of ID_ISAR3 to indicate the supported Synchronization Primitive instructions. Table B5-2 on page B5-30 shows the permitted values of these fields.

All combinations of SynchPrim_instrs and SynchPrim_instrs_frac not shown in Table B5-2 on page B5-30 are reserved.

Barrier_instrs, bits [19:16]

Indicates the supported Barrier instructions in the ARM and Thumb instruction sets. Permitted values are:

- 0b0000** None supported. Barrier operations are provided only as CP15 operations.
- 0b0001** Adds support for the DMB, DSB, and ISB barrier instructions.

If this field is set to a value other than 0b0000 then the L1 unified cache field, bits [23:20], must be set to 0b0000.

SMC_instrs, bits [15:12]

Indicates the supported SMC instructions. Permitted values are:

- 0b0000** Not supported.
- 0b0001** Adds support for the SMC instruction.

———— **Note** —————

The SMC instruction was called the SMI instruction in previous versions of the ARM architecture.

Writeback_instrs, bits [11:8]

Indicates the support for Writeback addressing modes. Permitted values are:

- 0b0000** Basic support. Only the LDM, STM, PUSH, POP, SRS, and RFE instructions support writeback addressing modes. These instructions support all of their writeback addressing modes.
- 0b0001** Adds support for all of the writeback addressing modes defined in ARMv7.

WithShifts_instrs, bits [7:4]

Indicates the support for instructions with shifts. Permitted values are:

- 0b0000** Nonzero shifts supported only in MOV and shift instructions.
- 0b0001** Adds support for shifts of loads and stores over the range LSL 0-3.
- 0b0011** As for 0b0001, and adds support for other constant shift options, both on load/store and other instructions.
- 0b0100** As for 0b0011, and adds support for register-controlled shift options.

———— **Note** —————

- In this field, the value of 0b0010 is reserved.
 - Additions to the basic support indicated by the 0b0000 field value only apply when the encoding supports them. In particular, in the Thumb instruction set there is no difference between the 0b0011 and 0b0100 levels of support.
 - MOV instructions with shift options are treated as ASR, LSL, LSR, ROR or RRX instructions, as described in *Data-processing instructions* on page B5-20.
-

Unpriv_instrs, bits [3:0]

Indicates the supported Unprivileged instructions. Permitted values are:

- 0b0000** None supported. No T variant instructions are implemented.
- 0b0001** Adds support for LDRBT, LDRT, STRBT, and STRT instructions.
- 0b0010** As for 0b0001, and adds support for LDRHT, LDRSBT, LDRSHT, and STRHT instructions.

c0, Instruction Set Attribute Register 5 (ID_ISAR5)

The format of the ID_ISAR5 is:

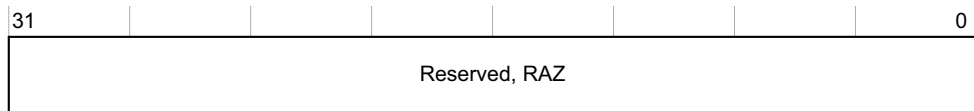

Bits [31:0] Reserved, RAZ.

Accessing the Instruction Set Attribute registers

To access the Instruction Set Attribute Registers you read the CP15 registers with <opc1> set to 0, <CRn> set to c0, <CRm> set to c2, and <opc2> set to:

- 0 for the ID_ISAR0
- 1 for the ID_ISAR1
- 2 for the ID_ISAR2
- 3 for the ID_ISAR3
- 4 for the ID_ISAR4
- 5 for the ID_ISAR5.

For example:

MRC p15, 0, <Rt>, c0, c2, 3 ; Read Instruction Set Attribute Register 3

B5.3 Advanced SIMD and VFP feature identification registers

When an implementation includes one or both of the optional Advanced SIMD and VFP extensions, the feature identification registers for the extensions are implemented in a common register block. The extensions reside in the coprocessor space for coprocessors CP10 and CP11, and the registers are accessed using the VMRS and VMSR instructions. For more information, see *Register map of the Advanced SIMD and VFP extension system registers* on page B1-66.

Table B5-3 lists the feature identification registers for the Advanced SIMD and VFP extensions. These are described in the remainder of this section.

When the Security Extensions are implemented, these registers are Common registers.

Table B5-3 Advanced SIMD and VFP feature identification registers

System register	Name	Description
0b0000	FPSID	See <i>Floating-point System ID Register (FPSID)</i>
0b0110	MVFR1	See <i>Media and VFP Feature Register 1 (MVFR1)</i> on page B5-38
0b0111	MVFR0	See <i>Media and VFP Feature Register 0 (MVFR0)</i> on page B5-36

B5.3.1 Floating-point System ID Register (FPSID)

In ARMv7, the FPSID Register provides top-level information about the floating-point implementation.

Note

- In an ARMv7 implementation that includes one or both of the Advanced SIMD and VFP extensions the Media and VFP Feature registers provide details of the implemented VFP architecture.
- The FPSID can be implemented in a system that provides only software emulation of the ARM floating-point instructions.

The ARMv7 format of the FPSID is:

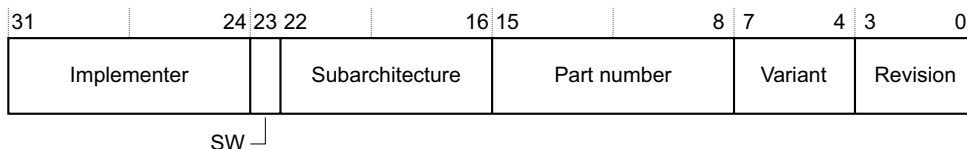

Implementer, bits [31:24]

Implementer codes are the same as those used for the Main ID Register, see:

- *c0*, *Main ID Register (MIDR)* on page B3-81, for a VMSA implementation
- *c0*, *Main ID Register (MIDR)* on page B4-32, for a PMSA implementation.

For an implementation by ARM this field is 0x41, the ASCII code for A.

SW, bit [23] Software flag. This bit is used to indicate that a system provides only software emulation of the VFP floating-point instructions:

- 0** The system includes hardware support for VFP floating-point operations.
- 1** The system provides only software emulation of the VFP floating-point instructions.

Subarchitecture, bits [22:16]

Subarchitecture version number. For an implementation by ARM, permitted values are:

0b0000000

VFPv1 architecture with an IMPLEMENTATION DEFINED subarchitecture.
Not permitted in an ARMv7 implementation.

0b0000001

VFPv2 architecture with Common VFP subarchitecture v1.
Not permitted in an ARMv7 implementation.

0b0000010

VFP architecture v3 or later with Common VFP subarchitecture v2. The VFP architecture version is indicated by the MVFR0 and MVFR1 registers.

0b0000011

VFP architecture v3 or later with Null subarchitecture. The entire floating-point implementation is in hardware, and no software support code is required. The VFP architecture version is indicated by the MVFR0 and MVFR1 registers.

This value can be used only by an implementation that does not support the trap enable bits in the FPSCR, see *Floating-point Status and Control Register (FPSCR)* on page A2-28.

0b0000100

VFP architecture v3 or later with Common VFP subarchitecture v3. The VFP architecture version is indicated by the MVFR0 and MVFR1 registers.

For a subarchitecture designed by ARM the most significant bit of this field, register bit [22], is 0. Values with a most significant bit of 0 that are not listed here are reserved.

When the subarchitecture designer is not ARM, the most significant bit of this field, register bit [22], must be 1. Each implementer must maintain its own list of subarchitectures it has designed, starting at subarchitecture version number 0x40.

Part number, bits [15:8]

An IMPLEMENTATION DEFINED part number for the floating-point implementation, assigned by the implementer.

Variant, bits [7:4]

An IMPLEMENTATION DEFINED variant number. Typically, this field is used to distinguish between different production variants of a single product.

Revision, bits [3:0]

An IMPLEMENTATION DEFINED revision number for the floating-point implementation.

B5.3.2 Media and VFP Feature registers

The Media and VFP Feature registers describe the features provided by the Advanced SIMD and VFP extensions, when an implementation includes either or both of these extensions. For details of the implementation options for these extensions see *Advanced SIMD and VFP extensions* on page A2-20.

In VFPv2, it is IMPLEMENTATION DEFINED whether the Media and VFP Feature registers are implemented.

———— Note —————

Often, the complete implementation of a VFP architecture uses support code to provide some VFP functionality. In such an implementation, only the support code can provide full details of the supported features. In this case the Media and VFP Feature registers are not used directly.

The Media and VFP Feature registers are described in:

- *Media and VFP Feature Register 0 (MVFR0)*
- *Media and VFP Feature Register 1 (MVFR1)* on page B5-38.

Media and VFP Feature Register 0 (MVFR0)

The format of the MVFR0 register is:

31	28	27	24	23	20	19	16	15	12	11	8	7	4	3	0
VFP rounding modes	Short vectors		Square root		Divide		VFP exception trapping		Double- precision		Single- precision		A_SIMD registers		

VFP rounding modes, bits [31:28]

Indicates the rounding modes supported by the VFP floating-point hardware. Permitted values are:

- 0b0000** Only Round to Nearest mode supported, except that Round towards Zero mode is supported for VCVT instructions that always use that rounding mode regardless of the FPSCR setting.
- 0b0001** All rounding modes supported.

Short vectors, bits [27:24]

Indicates the hardware support for VFP short vectors. Permitted values are:

- 0b0000** Not supported.
- 0b0001** Short vector operation supported.

Square root, bits [23:20]

Indicates the hardware support for VFP square root operations. Permitted values are:

0b0000 Not supported in hardware.

0b0001 Supported.

Note

- the FSQRTS instruction also requires the single-precision VFP attribute, bits [7:4]
 - the FSQRD instruction also requires the double-precision VFP attribute, bits [11:8].
-

Divide, bits [19:16]

Indicates the hardware support for VFP divide operations. Permitted values are:

0b0000 Not supported in hardware.

0b0001 Supported.

Note

- the FDIVS instruction also requires the single-precision VFP attribute, bits [7:4]
 - the FDIVD instruction also requires the double-precision VFP attribute, bits [11:8].
-

VFP exception trapping, bits [15:12]

Indicates whether the VFP hardware implementation supports exception trapping.

Permitted values are:

0b0000 Not supported. This is the value for VFPv3.

0b0001 Supported by the hardware. This is the value for VFPv3U, and for VFPv2.

When exception trapping is supported, support code is needed to handle the trapped exceptions.

Note

This value does not indicate that trapped exception handling is available. Because trapped exception handling requires support code, only the support code can provide this information.

Double-precision, bits [11:8]

Indicates the hardware support for VFP double-precision operations. Permitted values are:

0b0000 Not supported in hardware.

0b0001 Supported, VFPv2.

0b0010 Supported, VFPv3.

VFPv3 adds an instruction to load a double-precision floating-point constant, and conversions between double-precision and fixed-point values.

A value of 0b0001 or 0b0010 indicates support for all VFP double-precision instructions in the supported version of VFP, except that, in addition to this field being nonzero:

- FSQRTD is only available if the Square root field is 0b0001
- FDIVD is only available if the Divide field is 0b0001
- conversion between double-precision and single-precision is only available if the single-precision field is nonzero.

Single-precision, bits [7:4]

Indicates the hardware support for VFP single-precision operations. Permitted values are:

0b0000 Not supported in hardware.

0b0001 Supported, VFPv2.

0b0010 Supported, VFPv3.

VFPv3 adds an instruction to load a single-precision floating-point constant, and conversions between single-precision and fixed-point values.

A value of 0b0001 or 0b0010 indicates support for all VFP single-precision instructions in the supported version of VFP, except that, in addition to this field being nonzero:

- FSQRTS is only available if the Square root field is 0b0001
- FDIVS is only available if the Divide field is 0b0001
- conversion between double-precision and single-precision is only available if the double-precision field is nonzero.

A_SIMD registers, bits [3:0]

Indicates support for the Advanced SIMD register bank. Permitted values are:

0b0000 Not supported.

0b0001 Supported, 16 x 64-bit registers.

0b0010 Supported, 32 x 64-bit registers.

If this field is nonzero:

- all VFP LDC, STC, MCR, and MRC instructions are supported
- if the CPUID register shows that the MCRR and MRRC instructions are supported then the corresponding VFP instructions are supported.

Media and VFP Feature Register 1 (MVFR1)

The format of the MVFR1 register is:

31	28 27	24 23	20 19	16 15	12 11	8	7	4	3	0
Reserved, RAZ	VFP HPFP	A_SIMD HPFP	A_SIMD SPFP	A_SIMD integer	A_SIMD load/store	D_NaN mode			FtZ mode	

Bits [31:28] Reserved, RAZ.

VFP HPFP, bits[27:24]

Indicates whether the VFP supports half-precision floating-point conversion operations. Permitted values are:

- 0b0000** Not supported.
- 0b0001** Supported.

A_SIMD HPFP, bits[23:20]

Indicates whether Advanced SIMD supports half-precision floating-point conversion operations. Permitted values are:

- 0b0000** Not supported.
- 0b0001** Supported. This value is only permitted if the A_SIMD SPFP field is 0b0001.

A_SIMD SPFP, bits [19:16]

Indicates whether the Advanced SIMD extension supports single-precision floating-point operations. Permitted values are:

- 0b0000** Not supported.
- 0b0001** Supported. This value is only permitted if the A_SIMD integer field is 0b0001.

A_SIMD integer, bits [15:12]

Indicates whether the Advanced SIMD extension supports integer operations. Permitted values are:

- 0b0000** Not supported.
- 0b0001** Supported.

A_SIMD load/store, bits [11:8]

Indicates whether the Advanced SIMD extension supports load/store instructions. Permitted values are:

- 0b0000** Not supported.
- 0b0001** Supported.

D_NaN mode, bits [7:4]

Indicates whether the VFP hardware implementation supports only the Default NaN mode. Permitted values are:

- 0b0000** Hardware supports only the Default NaN mode. If a VFP subarchitecture is implemented its support code might include support for propagation of NaN values.
- 0b0001** Hardware supports propagation of NaN values.

FtZ mode, bits [7:4]

Indicates whether the VFP hardware implementation supports only the Flush-to-Zero mode of operation. Permitted values are:

0b0000 Hardware supports only the Flush-to-Zero mode of operation. If a VFP subarchitecture is implemented its support code might include support for full denormalized number arithmetic.

0b0001 Hardware supports full denormalized number arithmetic.

B5.3.3 Accessing the Advanced SIMD and VFP feature identification registers

You access the Advanced SIMD and VFP feature identification registers using the VMRS instruction, see *VMRS* on page [A8-658](#).

For example:

```
VMRS <Rt>, FPSID ; Read Floating-Point System ID Register
VMRS <Rt>, MVFR1 ; Read Media and VFP Feature Register 1
```

Chapter B6

System Instructions

This chapter describes the instructions that are only available, or that behave differently, in privileged modes. It contains the following section:

- *Alphabetical list of instructions* on page B6-2.

B6.1 Alphabetical list of instructions

This section lists every instruction that behaves differently in privileged modes, or that is only available in privileged modes. For information about privileged modes see *ARM processor modes and core registers* on page B1-6.

B6.1.1 CPS

Change Processor State is available only in privileged modes. It changes one or more of the A, I, and F interrupt disable bits and the mode bits of the CPSR, without changing the other CPSR bits.

Encoding T1 ARMv6*, ARMv7

CPS<effect> <iflags>

Not permitted in IT block.

15	14	13	12	11	10	9	8	7	6	5	4	3	2	1	0
1	0	1	1	0	1	1	0	0	1	1	im	(0)	A	I	F

```
enable = (im == '0');  disable = (im == '1');  changemode = FALSE;
affectA = (A == '1');  affectI = (I == '1');  affectF = (F == '1');
if InITBlock() then UNPREDICTABLE;
```

Encoding T2 ARMv6T2, ARMv7

CPS<effect>.W <iflags>{, #<mode>}

Not permitted in IT block.

CPS #<mode>

Not permitted in IT block.

15	14	13	12	11	10	9	8	7	6	5	4	3	2	1	0	15	14	13	12	11	10	9	8	7	6	5	4	3	2	1	0
1	1	1	1	0	0	1	1	1	0	1	0	(1)	(1)	(1)	(1)	(1)	1	0	(0)	0	(0)	imod	M	A	I	F	mode				

```
if imod == '00' && M == '0' then SEE "Hint instructions";
enable = (imod == '10');  disable = (imod == '11');  changemode = (M == '1');
affectA = (A == '1');  affectI = (I == '1');  affectF = (F == '1');
if imod == '01' || InITBlock() then UNPREDICTABLE;
```

Encoding A1 ARMv6*, ARMv7

CPS<effect> <iflags>{, #<mode>}

CPS #<mode>

31	30	29	28	27	26	25	24	23	22	21	20	19	18	17	16	15	14	13	12	11	10	9	8	7	6	5	4	3	2	1	0
1	1	1	1	0	0	0	1	0	0	0	0	imod	M	0	(0)	(0)	(0)	(0)	(0)	(0)	(0)	(0)	A	I	F	0	mode				

```
enable = (imod == '10');  disable = (imod == '11');  changemode = (M == '1');
affectA = (A == '1');  affectI = (I == '1');  affectF = (F == '1');
if (imod == '00' && M == '0') || imod == '01' then UNPREDICTABLE;
```

Assembler syntax

CPS<effect><q> <iflags> {, #<mode>}

CPS<q> #<mode>

where:

<effect> The effect required on the A, I, and F bits in the CPSR. This is one of:

- IE Interrupt Enable. This sets the specified bits to 0.
- ID Interrupt Disable. This sets the specified bits to 1.

If <effect> is specified, the bits to be affected are specified by <iflags>. The mode can optionally be changed by specifying a mode number as <mode>.

If <effect> is not specified, then:

- <iflags> is not specified and interrupt settings are not changed
- <mode> specifies the new mode number.

<q>	See <i>Standard assembler syntax fields</i> on page A8-7. A CPS instruction must be unconditional.						
<iflags>	Is a sequence of one or more of the following, specifying which interrupt disable flags are affected: <table border="0" style="margin-left: 20px;"> <tr> <td style="vertical-align: top; padding-right: 10px;">a</td> <td>Sets the A bit in the instruction, causing the specified effect on the CPSR.A (asynchronous abort) bit.</td> </tr> <tr> <td style="vertical-align: top; padding-right: 10px;">i</td> <td>Sets the I bit in the instruction, causing the specified effect on the CPSR.I (IRQ interrupt) bit.</td> </tr> <tr> <td style="vertical-align: top; padding-right: 10px;">f</td> <td>Sets the F bit in the instruction, causing the specified effect on the CPSR.F (FIQ interrupt) bit.</td> </tr> </table>	a	Sets the A bit in the instruction, causing the specified effect on the CPSR.A (asynchronous abort) bit.	i	Sets the I bit in the instruction, causing the specified effect on the CPSR.I (IRQ interrupt) bit.	f	Sets the F bit in the instruction, causing the specified effect on the CPSR.F (FIQ interrupt) bit.
a	Sets the A bit in the instruction, causing the specified effect on the CPSR.A (asynchronous abort) bit.						
i	Sets the I bit in the instruction, causing the specified effect on the CPSR.I (IRQ interrupt) bit.						
f	Sets the F bit in the instruction, causing the specified effect on the CPSR.F (FIQ interrupt) bit.						
<mode>	The number of the mode to change to. If this option is omitted, no mode change occurs.						

Operation

```

EncodingSpecificOperations();
if CurrentModeIsPrivileged() then
    cpsr_val = CPSR;
    if enable then
        if affectA then cpsr_val<8> = '0';
        if affectI then cpsr_val<7> = '0';
        if affectF then cpsr_val<6> = '0';
    if disable then
        if affectA then cpsr_val<8> = '1';
        if affectI then cpsr_val<7> = '1';
        if affectF then cpsr_val<6> = '1';
    if changemode then
        cpsr_val<4:0> = mode;
    CPSRWriteByInstr(cpsr_val, '1111', TRUE);

```

Exceptions

None.

Hint instructions

If the imod field and the M bit in encoding T2 are '00' and '0' respectively, a hint instruction is encoded. To determine which hint instruction, see *Change Processor State, and hints* on page A6-21.

B6.1.2 LDM (exception return)

Load Multiple (exception return) loads multiple registers from consecutive memory locations using an address from a base register. The SPSR of the current mode is copied to the CPSR. An address adjusted by the size of the data loaded can optionally be written back to the base register.

The registers loaded include the PC. The word loaded for the PC is treated as an address and a branch occurs to that address.

Encoding A1 ARMv4*, ARMv5T*, ARMv6*, ARMv7

LDM{<amode>}<c> <Rn>{!}, <registers_with_pc>^

31	30	29	28	27	26	25	24	23	22	21	20	19	18	17	16	15	14	13	12	11	10	9	8	7	6	5	4	3	2	1	0
cond		1	0	0	P	U	1	W	1	Rn				1	register_list																

```
n = UInt(Rn); registers = register_list;
wback = (W == '1'); increment = (U == '1'); wordhigher = (P == U);
if n == 15 then UNPREDICTABLE;
if wback && registers<n> == '1' && ArchVersion() >= 7 then UNPREDICTABLE;
```

Assembler syntax

LDM{<amode>}<c><q> <Rn>{!}, <registers_with_pc>^

where:

<c><q> See *Standard assembler syntax fields* on page A8-7.

<amode> is one of:

- DA Decrement After. The consecutive memory addresses end at the address in the base register. For this instruction, FA, meaning Full Ascending, is equivalent to DA. Encoded as P = 0, U = 0.
- DB Decrement Before. The consecutive memory addresses end one word below the address in the base register. For this instruction, EA, meaning Empty Ascending, is equivalent to DB. Encoded as P = 1, U = 0.
- IA Increment After. The consecutive memory addresses start at the address in the base register. This is the default, and is normally omitted. For this instruction, FD, meaning Full Descending, is equivalent to IA. Encoded as P = 0, U = 1.
- IB Increment Before. The consecutive memory addresses start one word above the address in the base register. For this instruction, ED, meaning Empty Descending, is equivalent to IB. Encoded as P = 1, U = 1.

<Rn> The base register. This register can be the SP.

! Causes the instruction to write a modified value back to <Rn>. Encoded as W = 1.

If ! is omitted, the instruction does not change <Rn> in this way. Encoded as W = 0.

<registers_with_pc>

Is a list of one or more registers, separated by commas and surrounded by { and }. It specifies the set of registers to be loaded. The registers are loaded with the lowest-numbered register from the lowest memory address, through to the highest-numbered register from the highest memory address. The PC must be specified in the register list, and the instruction causes a branch to the address (data) loaded into the PC.

The pre-UAL syntax LDM<c>{<amode>} is equivalent to LDM{<amode>}<c>.

Note

Instructions with similar syntax but without the PC included in <registers> are described in *LDM (user registers)* on page B6-7.

Operation

```

if ConditionPassed() then
    EncodingSpecificOperations();
    if CurrentModeIsUserOrSystem() then UNPREDICTABLE;
    length = 4*BitCount(registers) + 4;
    address = if increment then R[n] else R[n]-length;
    if wordhigher then address = address+4;
    for i = 0 to 14
        if registers<i> == '1' then
            R[i] = MemA[address,4]; address = address + 4;
    new_pc_value = MemA[address,4];
    if wback && registers<n> == '0' then R[n] = if increment then R[n]+length else R[n]-length;
    if wback && registers<n> == '1' then R[n] = bits(32) UNKNOWN;
    CPSRWriteByInstr(SPSR[], '1111', TRUE);
    BranchWritePC(new_pc_value);

```

Exceptions

Data Abort.

B6.1.3 LDM (user registers)

Load Multiple (user registers) is UNPREDICTABLE in User or System modes. In exception modes, it loads multiple User mode registers from consecutive memory locations using an address from a ~~banked~~-base register. Writeback to the base register is not available with this instruction.



The registers loaded cannot include the PC.

Encoding A1 ARMv4*, ARMv5T*, ARMv6*, ARMv7

LDM{<amode>}<c> <Rn>, <registers_without_pc>^

31	30	29	28	27	26	25	24	23	22	21	20	19	18	17	16	15	14	13	12	11	10	9	8	7	6	5	4	3	2	1	0
cond		1	0	0	P	U	1	(0)	1	Rn				0	register_list																

n = UInt(Rn); registers = register_list; increment = (U == '1'); wordhigher = (P == U);
if n == 15 || BitCount(registers) < 1 then UNPREDICTABLE;

Assembler syntax

LDM{<amode>}<c><q> <Rn>, <registers_without_pc>^

where:

<c><q> See *Standard assembler syntax fields* on page A8-7.

<amode> is one of:

- DA Decrement After. The consecutive memory addresses end at the address in the base register. For this instruction, FA, meaning Full Ascending, is equivalent to DA. Encoded as P = 0, U = 0.
- DB Decrement Before. The consecutive memory addresses end one word below the address in the base register. For this instruction, EA, meaning Empty Ascending, is equivalent to DB. Encoded as P = 1, U = 0.
- IA Increment After. The consecutive memory addresses start at the address in the base register. This is the default, and is normally omitted. For this instruction, FD, meaning Full Descending, is equivalent to IA. Encoded as P = 0, U = 1.
- IB Increment Before. The consecutive memory addresses start one word above the address in the base register. For this instruction, ED, meaning Empty Descending, is equivalent to IB. Encoded as P = 1, U = 1.

<Rn> The base register. This register can be the SP.

<registers_without_pc>

Is a list of one or more registers, separated by commas and surrounded by { and }. It specifies the set of registers to be loaded by the LDM instruction. The registers are loaded with the lowest-numbered register from the lowest memory address, through to the highest-numbered register from the highest memory address. The PC must not be in the register list.

The pre-UAL syntax LDM<c>{<amode>} is equivalent to LDM{<amode>}<c>.

Note

Instructions with similar syntax but with the PC included in <registers> are described in *LDM (exception return)* on page B6-5.

Operation

```
if ConditionPassed() then
    EncodingSpecificOperations();
    if CurrentModeIsUserOrSystem() then UNPREDICTABLE;
    length = 4*BitCount(registers);
    address = if increment then R[n] else R[n]-length;
    if wordhigher then address = address+4;
    for i = 0 to 14
        if registers<i> == '1' then // Load User mode ('10000') register
            Rmode[i, '10000'] = MemA[address,4]; address = address + 4;
```

Exceptions

Data Abort.

B6.1.4 LDRBT, LDRHT, LDRSBT, LDRSHT, and LDRT

Even in privileged modes, loads from memory by these instructions are restricted in the same way as loads from memory in User mode. This is encapsulated in the MemA_unpriv[] and MemU_unpriv[] pseudocode functions. For details see *Aligned memory accesses* on page B2-31 and *Unaligned memory accesses* on page B2-32.

For details of the instructions see:

- *LDRBT* on page A8-134
- *LDRHT* on page A8-158
- *LDRSBT* on page A8-166
- *LDRSHT* on page A8-174
- *LDRT* on page A8-176.

B6.1.5 MRS

Move to Register from Special Register moves the value from the CPSR or SPSR of the current mode into a general-purpose register.

Encoding T1 ARMv6T2, ARMv7

MRS<c> <Rd>, <spec_reg>

15	14	13	12	11	10	9	8	7	6	5	4	3	2	1	0	15	14	13	12	11	10	9	8	7	6	5	4	3	2	1	0
1	1	1	1	0	0	1	1	1	1	1	R	(1)	(1)	(1)	(1)	1	0	(0)	0	Rd	(0)	(0)	(0)	(0)	(0)	(0)	(0)	(0)			

```
d = UInt(Rd); read_spsr = (R == '1');
if BadReg(d) then UNPREDICTABLE;
```

Encoding A1 ARMv4*, ARMv5T*, ARMv6*, ARMv7

MRS<c> <Rd>, <spec_reg>

31	30	29	28	27	26	25	24	23	22	21	20	19	18	17	16	15	14	13	12	11	10	9	8	7	6	5	4	3	2	1	0
cond	0	0	0	1	0	R	0	0	(1)	(1)	(1)	(1)	Rd	(0)	(0)	(0)	(0)	0	0	0	0	(0)	(0)	(0)	(0)	(0)	(0)	(0)	(0)	(0)	

```
d = UInt(Rd); read_spsr = (R == '1');
if d == 15 then UNPREDICTABLE;
```

Assembler syntax

MRS<c><q> <Rd>, <spec_reg>

where:

<c><q> See *Standard assembler syntax fields* on page A8-7.

<Rd> The destination register.

<spec_reg> Is one of:

- APSR
- CPSR
- SPSR.

ARM recommends the APSR form when only the N, Z, C, V, Q, or GE[3:0] bits of the read value are going to be used (see *The Application Program Status Register (APSR)* on page A2-14).

Operation

```
if ConditionPassed() then
    EncodingSpecificOperations();
    if read_spsr then
        if CurrentModeIsUserOrSystem() then
            UNPREDICTABLE;
        else
            R[d] = SPSR[];
    else
        // CPSR is read with execution state bits other than E masked out.
        R[d] = CPSR AND '11111000 11111111 00000011 11011111';
```

Exceptions

None.

B6.1.6 MSR (immediate)

Move immediate value to Special Register moves selected bits of an immediate value to the CPSR or the SPSR of the current mode.

Encoding A1 ARMv4*, ARMv5T*, ARMv6*, ARMv7

MSR<c> <spec_reg>, #<const>

31	30	29	28	27	26	25	24	23	22	21	20	19	18	17	16	15	14	13	12	11	10	9	8	7	6	5	4	3	2	1	0
cond				0	0	1	1	0	R	1	0	mask				(1)	(1)	(1)	(1)	imm12											

```
if mask == '0000' && R == '0' then SEE "Related encodings";
imm32 = ARMEExpandImm(imm12); write_spsr = (R == '1');
if mask == '0000' then UNPREDICTABLE;
if n == 15 then UNPREDICTABLE;
```

Assembler syntax

MSR<c><q> <spec_reg>, #<const>

where:

<c><q> See *Standard assembler syntax fields* on page A8-7.

<spec_reg> Is one of:

- APSR_<bits>
- CPSR_<fields>
- SPSR_<fields>.

ARM recommends the APSR forms when only the N, Z, C, V, Q, and GE[3:0] bits are being written. For more information, see *The Application Program Status Register (APSR)* on page A2-14.

<const> The immediate value to be transferred to <spec_reg>. See *Modified immediate constants in ARM instructions* on page A5-9 for the range of values.

<bits> Is one of nzcqvq, g, or nzcvqg.

In the A and R profiles:

- APSR_nzcqvq is the same as CPSR_f (mask == '1000')
- APSR_g is the same as CPSR_s (mask == '0100')
- APSR_nzcvqg is the same as CPSR_fs (mask == '1100').

<fields> Is a sequence of one or more of the following:

- c mask<0> = '1' to enable writing of bits<7:0> of the destination PSR
- x mask<1> = '1' to enable writing of bits<15:8> of the destination PSR
- s mask<2> = '1' to enable writing of bits<23:16> of the destination PSR
- f mask<3> = '1' to enable writing of bits<31:24> of the destination PSR.

Operation

```
if ConditionPassed() then
    EncodingSpecificOperations();
    if write_spsr then
        SPSRWriteByInstr(imm32, mask);
    else
        CPSRWriteByInstr(imm32, mask, FALSE); // Does not affect execution state bits
                                              // other than E
```

Exceptions

None.

E bit

The CPSR.E bit is writable from any mode using an MSR instruction. Use of this to change its value is deprecated. Use the SETEND instruction instead.

B6.1.7 MSR (register)

Move to Special Register from ARM core register moves the value of a general-purpose register to the CPSR or the SPSR of the current mode.

Encoding T1 ARMv6T2, ARMv7

MSR<c> <spec_reg>, <Rn>

15	14	13	12	11	10	9	8	7	6	5	4	3	2	1	0	15	14	13	12	11	10	9	8	7	6	5	4	3	2	1	0
1	1	1	1	0	0	1	1	1	0	0	R		Rn			1	0	(0)	0		mask		(0)	(0)	(0)	(0)	(0)	(0)	(0)	(0)	

```
n = UInt(Rn); write_spsr = (R == '1');
if mask == '0000' then UNPREDICTABLE;
if BadReg(n) then UNPREDICTABLE;
```

Encoding A1 ARMv4*, ARMv5T*, ARMv6*, ARMv7

MSR<c> <spec_reg>, <Rn>

31	30	29	28	27	26	25	24	23	22	21	20	19	18	17	16	15	14	13	12	11	10	9	8	7	6	5	4	3	2	1	0
cond		0	0	0	1	0	R	1	0		mask	(1)	(1)	(1)	(1)	(0)	(0)	(0)	(0)		0	0	0	0					Rn		

```
n = UInt(Rn); write_spsr = (R == '1');
if mask == '0000' then UNPREDICTABLE;
if n == 15 then UNPREDICTABLE;
```

Assembler syntax

MSR<c><q> <spec_reg>, <Rn>

where:

<c><q> See *Standard assembler syntax fields* on page A8-7.

<spec_reg> Is one of:

- APSR_<bits>
- CPSR_<fields>
- SPSR_<fields>.

ARM recommends the APSR forms when only the N, Z, C, V, Q, and GE[3:0] bits are being written. For more information, see *The Application Program Status Register (APSR)* on page A2-14.

<Rn> Is the general-purpose register to be transferred to <spec_reg>.

<bits> Is one of nzcqvq, g, or nzcvgg.

In the A and R profiles:

- APSR_nzcqvq is the same as CPSR_f (mask == '1000')
- APSR_g is the same as CPSR_s (mask == '0100')
- APSR_nzcvgg is the same as CPSR_fs (mask == '1100').

<fields> Is a sequence of one or more of the following:

- c mask<0> = '1' to enable writing of bits<7:0> of the destination PSR
- x mask<1> = '1' to enable writing of bits<15:8> of the destination PSR
- s mask<2> = '1' to enable writing of bits<23:16> of the destination PSR
- f mask<3> = '1' to enable writing of bits<31:24> of the destination PSR.

Operation

```

if ConditionPassed() then
    EncodingSpecificOperations();
    if write_spsr then
        SPSRWriteByInstr(R[n], mask);
    else
        CPSRWriteByInstr(R[n], mask, FALSE); // Does not affect execution state bits
                                             // other than E

```

Exceptions

None.

E bit

The CPSR.E bit is writable from any mode using an MSR instruction. Use of this to change its value is deprecated. Use the SETEND instruction instead.

B6.1.8 RFE

Return From Exception loads the PC and the CPSR from the word at the specified address and the following word respectively. For information about memory accesses see *Memory accesses* on page A8-13.

Encoding T1 ARMv6T2, ARMv7

RFEDB<c> <Rn>{!}

Outside or last in IT block

15	14	13	12	11	10	9	8	7	6	5	4	3	2	1	0	15	14	13	12	11	10	9	8	7	6	5	4	3	2	1	0
1	1	1	0	1	0	0	0	0	0	W	1	Rn				(1)	(1)	(0)	(0)	(0)	(0)	(0)	(0)	(0)	(0)	(0)	(0)	(0)	(0)	(0)	

$n = \text{UInt}(Rn)$; wback = (W == '1'); increment = FALSE; wordhigher = FALSE;
 if n == 15 then UNPREDICTABLE;
 if InITBlock() && !LastInITBlock() then UNPREDICTABLE;

Encoding T2 ARMv6T2, ARMv7

RFE{IA}<c> <Rn>{!}

Outside or last in IT block

15	14	13	12	11	10	9	8	7	6	5	4	3	2	1	0	15	14	13	12	11	10	9	8	7	6	5	4	3	2	1	0
1	1	1	0	1	0	0	1	1	0	W	1	Rn				(1)	(1)	(0)	(0)	(0)	(0)	(0)	(0)	(0)	(0)	(0)	(0)	(0)	(0)		

$n = \text{UInt}(Rn)$; wback = (W == '1'); increment = TRUE; wordhigher = FALSE;
 if n == 15 then UNPREDICTABLE;
 if InITBlock() && !LastInITBlock() then UNPREDICTABLE;

Encoding A1 ARMv6*, ARMv7

RFE{<amode>} <Rn>{!}

31	30	29	28	27	26	25	24	23	22	21	20	19	18	17	16	15	14	13	12	11	10	9	8	7	6	5	4	3	2	1	0
1	1	1	1	1	0	0	P	U	0	W	1	Rn				(0)	(0)	(0)	(0)	(1)	(0)	(1)	(0)	(0)	(0)	(0)	(0)	(0)	(0)	(0)	(0)

$n = \text{UInt}(Rn)$;
 wback = (W == '1'); inc = (U == '1'); wordhigher = (P == U);
 if n == 15 then UNPREDICTABLE;

Assembler syntax

RFE{<amode>}<c><q> <Rn>{!}

where:

<amode> is one of:

- DA Decrement After. ARM code only. The consecutive memory addresses end at the address in the base register. Encoded as P = 0, U = 0 in encoding A1.
- DB Decrement Before. The consecutive memory addresses end one word below the address in the base register. Encoding T1, or encoding A1 with P = 1, U = 0.
- IA Increment After. The consecutive memory addresses start at the address in the base register. This is the default, and is normally omitted. Encoding T2, or encoding A1 with P = 0, U = 1.
- IB Increment Before. ARM code only. The consecutive memory addresses start one word above the address in the base register. Encoded as P = 1, U = 1 in encoding A1.

<c><q> See *Standard assembler syntax fields* on page A8-7. An ARM RFE instruction must be unconditional.

<Rn> The base register.

! Causes the instruction to write a modified value back to <Rn>. If ! is omitted, the instruction does not change <Rn>.

RFEFA, RFEFA, RFEFD, and RFEED are pseudo-instructions for RFEDA, RFEDB, RFEIA, and RFEIB respectively, referring to their use for popping data from Full Ascending, Empty Ascending, Full Descending, and Empty Descending stacks.

Operation

```

if ConditionPassed() then
    EncodingSpecificOperations();
    if !CurrentModeIsPrivileged() || CurrentInstrSet() == InstrSet_ThumbEE then
        UNPREDICTABLE;
    else
        address = if increment then R[n] else R[n]-8;
        if wordhigher then address = address+4;
        CPSRWriteByInstr(MemA[address+4,4], '1111', TRUE);
        BranchWritePC(MemA[address,4]);
        if wback then R[n] = if increment then R[n]+8 else R[n]-8;

```

Exceptions

Data Abort.

B6.1.9 SMC (previously SMI)

Secure Monitor Call causes a Secure Monitor exception. It is available only in privileged modes. An attempt to execute this instruction in User mode causes an Undefined Instruction exception.

For details of the effects of a Secure Monitor exception see *Secure Monitor Call (SMC) exception* on page B1-53.

Encoding T1 Security Extensions (not in ARMv6K)

SMC<c> #<imm4>

15	14	13	12	11	10	9	8	7	6	5	4	3	2	1	0	15	14	13	12	11	10	9	8	7	6	5	4	3	2	1	0
1	1	1	1	0	1	1	1	1	1	1	1	imm4			1	0	0	0	(0)	(0)	(0)	(0)	(0)	(0)	(0)	(0)	(0)	(0)	(0)	(0)	

```
imm32 = ZeroExtend(imm4, 32);
// imm32 is for assembly/disassembly only and is ignored by hardware
if InITBlock() && !LastInITBlock() then UNPREDICTABLE;
```

Encoding A1 Security Extensions

SMC<c> #<imm4>

31	30	29	28	27	26	25	24	23	22	21	20	19	18	17	16	15	14	13	12	11	10	9	8	7	6	5	4	3	2	1	0
cond		0	0	0	1	0	1	1	0	(0)	(0)	(0)	(0)	(0)	(0)	(0)	(0)	(0)	(0)	(0)	(0)	(0)	(0)	0	1	1	1	imm4			

```
imm32 = ZeroExtend(imm4, 32);
// imm32 is for assembly/disassembly only and is ignored by hardware
```

Assembler syntax

SMC<c><q> #<imm4>

where:

<c><q> See *Standard assembler syntax fields* on page A8-7.

<imm4> Is a 4-bit immediate value. This is ignored by the ARM processor. It can be used by the SMC exception handler (Secure Monitor code) to determine what service is being requested, but this is not recommended.

The pre-UAL syntax SMI<c> is equivalent to SMC<c>.

Operation

```

if ConditionPassed() then
    EncodingSpecificOperations();
    if HaveSecurityExt() && CurrentModeIsPrivileged() then
        TakeSMCException();           // Secure Monitor Call if privileged
    else
        UNDEFINED;

```

Exceptions

Secure Monitor Call.

B6.1.10 SRS

Store Return State stores the LR and SPSR of the current mode to the stack of a specified mode. For information about memory accesses see *Memory accesses* on page A8-13.

Encoding T1 ARMv6T2, ARMv7

SRSDB<c> SP{!},#<mode>

15	14	13	12	11	10	9	8	7	6	5	4	3	2	1	0	15	14	13	12	11	10	9	8	7	6	5	4	3	2	1	0
1	1	1	0	1	0	0	0	0	0	W	0	(1)	(1)	(0)	(1)	(1)	(1)	(0)	(0)	(0)	(0)	(0)	(0)	(0)	(0)	(0)	(0)	(0)	mode		

```
wback = (W == '1'); increment = FALSE; wordhigher = FALSE;
// In Non-secure state, check for attempts to access Monitor mode ('10110'), or FIQ
// mode ('10001') when the Security Extensions are reserving the FIQ registers. The
// definition of UNPREDICTABLE does not permit this to be a security hole.
if !IsSecure() && mode == '10110' then UNPREDICTABLE;
if !IsSecure() && mode == '10001' && NSACR.RFR == '1' then UNPREDICTABLE;
```

Encoding T2 ARMv6T2, ARMv7

SRS{IA}<c> SP{!},#<mode>

15	14	13	12	11	10	9	8	7	6	5	4	3	2	1	0	15	14	13	12	11	10	9	8	7	6	5	4	3	2	1	0
1	1	1	0	1	0	0	1	1	0	W	0	(1)	(1)	(0)	(1)	(1)	(1)	(0)	(0)	(0)	(0)	(0)	(0)	(0)	(0)	(0)	(0)	mode			

```
wback = (W == '1'); increment = TRUE; wordhigher = FALSE;
// In Non-secure state, check for attempts to access Monitor mode ('10110'), or FIQ
// mode ('10001') when the Security Extensions are reserving the FIQ registers. The
// definition of UNPREDICTABLE does not permit this to be a security hole.
if !IsSecure() && mode == '10110' then UNPREDICTABLE;
if !IsSecure() && mode == '10001' && NSACR.RFR == '1' then UNPREDICTABLE;
```

Encoding A1 ARMv6*, ARMv7

SRS{<amode>} SP{!},#<mode>

31	30	29	28	27	26	25	24	23	22	21	20	19	18	17	16	15	14	13	12	11	10	9	8	7	6	5	4	3	2	1	0
1	1	1	1	1	0	0	P	U	1	W	0	(1)	(1)	(0)	(1)	(0)	(0)	(0)	(0)	(0)	(1)	(0)	(1)	(0)	(0)	(0)	(0)	(0)	(0)	mode	

```
wback = (W == '1'); inc = (U == '1'); wordhigher = (P == U);
// In Non-secure state, check for attempts to access Monitor mode ('10110'), or FIQ
// mode ('10001') when the Security Extensions are reserving the FIQ registers. The
// definition of UNPREDICTABLE does not permit this to be a security hole.
if !IsSecure() && mode == '10110' then UNPREDICTABLE;
if !IsSecure() && mode == '10001' && NSACR.RFR == '1' then UNPREDICTABLE;
```

Assembler syntax

SRS{<amode>}<c><q> SP{!}, #<mode>

where:

<amode> is one of:

- DA Decrement After. ARM code only. The consecutive memory addresses end at the address in the base register. Encoded as P = 0, U = 0 in encoding A1.
- DB Decrement Before. The consecutive memory addresses end one word below the address in the base register. Encoding T1, or encoding A1 with P = 1, U = 0.
- IA Increment After. The consecutive memory addresses start at the address in the base register. This is the default, and is normally omitted. Encoding T2, or encoding A1 with P = 0, U = 1.
- IB Increment Before. ARM code only. The consecutive memory addresses start one word above the address in the base register. Encoded as P = 1, U = 1 in encoding A1.

<c><q> See *Standard assembler syntax fields* on page A8-7. An ARM SRS instruction must be unconditional.

! Causes the instruction to write a modified value back to the base register (encoded as W = 1). If ! is omitted, the instruction does not change the base register (encoded as W = 0).

<mode> The number of the mode whose banked SP is used as the base register. For details of processor modes and their numbers see *ARM processor modes* on page B1-6.

SRSFA, SRSEA, SRSFD, and SRSED are pseudo-instructions for SRSIB, SRSIA, SRSDB, and SRSDA respectively, referring to their use for pushing data onto Full Ascending, Empty Ascending, Full Descending, and Empty Descending stacks.

Operation

```

if ConditionPassed() then
    EncodingSpecificOperations();
    if CurrentModeIsUserOrSystem() || CurrentInstrSet() == InstrSet_ThumbEE then
        UNPREDICTABLE;
    else
        base = Rmode[13,mode];
        address = if increment then base else base-8;
        if wordhigher then address = address+4;
        MemA[address,4] = LR;
        MemA[address+4,4] = SPSR[];
        if wback then Rmode[13] = if increment then base+8 else base-8;

```

Exceptions

Data Abort.

B6.1.11 STM (user registers)

Store Multiple (user registers) is UNPREDICTABLE in User or System modes. In exception modes, it stores multiple User mode registers to consecutive memory locations using an address from a ~~banked~~ base register. Writeback to the base register is not available with this instruction.



Encoding A1 ARMv4*, ARMv5T*, ARMv6*, ARMv7

STM{amode}<c> <Rn>, <registers>^

31	30	29	28	27	26	25	24	23	22	21	20	19	18	17	16	15	14	13	12	11	10	9	8	7	6	5	4	3	2	1	0
cond		1	0	0	P	U	1	(0)	0	Rn								register_list													

```
n = UInt(Rn); registers = register_list; increment = (U == '1'); wordhigher = (P == U);
if n == 15 || BitCount(registers) < 1 then UNPREDICTABLE;
```

Assembler syntax

STM{amode}<c><q> <Rn>, <registers>^

where:

<c><q> See *Standard assembler syntax fields* on page A8-7.

amode is one of:

DA Decrement After. The consecutive memory addresses end at the address in the base register. For this instruction, ED, meaning Empty Descending, is equivalent to DA. Encoded as P = 0, U = 0.

DB Decrement Before. The consecutive memory addresses end one word below the address in the base register. For this instruction, FD, meaning Full Descending, is equivalent to DB. Encoded as P = 1, U = 0.

IA Increment After. The consecutive memory addresses start at the address in the base register. This is the default, and is normally omitted. For this instruction, EA, meaning Empty Ascending, is equivalent to IA. Encoded as P = 0, U = 1.

IB Increment Before. The consecutive memory addresses start one word above the address in the base register. For this instruction, FA, meaning Full Ascending, is equivalent to IB. Encoded as P = 1, U = 1.

<Rn> The base register. This register can be the SP.

<registers> Is a list of one or more registers, separated by commas and surrounded by { and }. It specifies the set of registers to be stored by the STM instruction. The registers are stored with the lowest-numbered register to the lowest memory address, through to the highest-numbered register to the highest memory address.

The pre-UAL syntax STM<c>{amode} is equivalent to STM{amode}<c>.

Operation

```

if ConditionPassed() then
    EncodingSpecificOperations();
if CurrentModeIsUserOrSystem() then UNPREDICTABLE;
length = 4*BitCount(registers);
address = if increment then R[n] else R[n]-length;
if wordhigher then address = address+4;
for i = 0 to 14
    if registers<i> == '1' then / Store User mode ('10000') register
        MemA[address,4] = Rmode[i, '10000'];
        address = address + 4;
if registers<15> == '1' then
    MemA[address,4] = PCStoreValue();

```

Exceptions

Data Abort.

B6.1.12 STRBT, STRHT, and STRT

Even in privileged modes, stores to memory by these instructions are restricted in the same way as stores to memory in User mode. This is encapsulated in the MemA_unpriv[] and MemU_unpriv[] pseudocode functions. For details see *Aligned memory accesses* on page B2-31 and *Unaligned memory accesses* on page B2-32.

For details of the instructions see:

- *STRBT* on page A8-394
- *STRHT* on page A8-414
- *STRT* on page A8-416.

B6.1.13 SUBS PC, LR and related instructions

The SUBS PC, LR, #<const> instruction provides an exception return without the use of the stack. It subtracts the immediate constant from LR, branches to the resulting address, and also copies the SPSR to the CPSR. The ARM instruction set contains similar instructions based on other data-processing operations, with a wider range of operands, or both. The use of these other instructions is deprecated, except for MOV_S PC, LR.

Encoding T1 ARMv6T2, ARMv7

SUBS<c> PC,LR,#<imm8>

Outside or last in IT block

15	14	13	12	11	10	9	8	7	6	5	4	3	2	1	0	15	14	13	12	11	10	9	8	7	6	5	4	3	2	1	0
1	1	1	1	0	0	1	1	1	1	0	1	(1)	(1)	(1)	(0)	1	0	(0)	0	(1)	(1)	(1)	(1)	imm8							

```
n = 14; imm32 = ZeroExtend(imm8, 32); register_form = FALSE; opcode = '0010'; // = SUB
if InITBlock() && !LastInITBlock() then UNPREDICTABLE;
```

Encoding A1 ARMv4*, ARMv5T*, ARMv6*, ARMv7

<opc1>S<c> PC,<Rn>,<const>

<opc2>S<c> PC,<const>

31	30	29	28	27	26	25	24	23	22	21	20	19	18	17	16	15	14	13	12	11	10	9	8	7	6	5	4	3	2	1	0
cond		0	0	1	opcode			1	Rn			1	1	1	1	imm12															

```
n = UInt(Rn); imm32 = ARMEExpandImm(imm12); register_form = FALSE;
```

Encoding A2 ARMv4*, ARMv5T*, ARMv6*, ARMv7

<opc1>S<c> PC,<Rn>,<Rm>{,<shift>}

<opc2>S<c> PC,<Rm>{,<shift>}

31	30	29	28	27	26	25	24	23	22	21	20	19	18	17	16	15	14	13	12	11	10	9	8	7	6	5	4	3	2	1	0
cond		0	0	0	opcode			1	Rn			1	1	1	1	imm5			type		0	Rm									

```
n = UInt(Rn); m = UInt(Rm); register_form = TRUE;
(shift_t, shift_n) = DecodeImmShift(type, imm5);
```

Assembler syntax

SUBS<c><q> PC, LR, #<const>	Encodings T1, A1
<opc1>S<c><q> PC, <Rn>, #<const>	Encoding A1
<opc1>S<c><q> PC, <Rn>, <Rm> {,<shift>}	Encoding A2, deprecated
<opc2>S<c><q> PC, #<const>	Encoding A1, deprecated
<opc2>S<c><q> PC, <Rm> {,<shift>}	Encoding A2

where:

<c><q> See *Standard assembler syntax fields* on page A8-7.

<opc1>	The operation. <opc1> is one of ADC, ADD, AND, BIC, EOR, ORR, RSB, RSC, SBC, and SUB. Use of all of these operations except SUB is deprecated.
<opc2>	The operation. <opc2> is MOV or MVN. Use of MVN is deprecated.
<Rn>	The first operand register. Use of any register except LR is deprecated.
<const>	The immediate constant. For encoding T1, <const> is in the range 0-255. See <i>Modified immediate constants in ARM instructions</i> on page A5-9 for the range of available values in encoding A1.
<Rm>	The optionally shifted second or only operand register. Use of any register except LR is deprecated.
<shift>	The shift to apply to the value read from <Rm>. If absent, no shift is applied. The shifts and how they are encoded are described in Shifts applied to a register on page A8-10. Use of <shift> is deprecated.

The value of the operation <opc1> or <opc2> is encoded in the opcode field of the instruction. For the opcode values for different operations see *Operation* on page B6-6.

In Thumb code, MOV<S><C><Q> PC,LR is a pseudo-instruction for SUBS<C><Q> PC,LR,#0.

The pre-UAL syntax <opc1><C>S is equivalent to <opc1>S<C>. The pre-UAL syntax <opc2><C>S is equivalent to <opc2>S<C>.

Operation

```

if ConditionPassed() then
    EncodingSpecificOperations();
    if CurrentInstrSet() == InstrSet_ThumbEE then
        UNPREDICTABLE;
        operand2 = if register_form then Shift(R[m], shift_t, shift_n, APSR.C) else imm32;
        case opcode of
            when '0000' result = R[n] AND operand2; // AND
            when '0001' result = R[n] EOR operand2; // EOR
            when '0010' (result, -, -) = AddWithCarry(R[n], NOT(operand2), '1'); // SUB
            when '0011' (result, -, -) = AddWithCarry(NOT(R[n]), operand2, '1'); // RSB
            when '0100' (result, -, -) = AddWithCarry(R[n], operand2, '0'); // ADD
            when '0101' (result, -, -) = AddWithCarry(R[n], operand2, APSR.c); // ADC
            when '0110' (result, -, -) = AddWithCarry(R[n], NOT(operand2), APSR.C); // SBC
            when '0111' (result, -, -) = AddWithCarry(NOT(R[n]), operand2, APSR.C); // RSC
            when '1100' result = R[n] OR operand2; // ORR
            when '1101' result = operand2; // MOV
            when '1110' result = R[n] AND NOT(operand2); // BIC
            when '1111' result = NOT(operand2); // MVN
        CPSRWriteByInstr(SPSR[], '1111', TRUE);
        BranchWritePC(result);

```

Exceptions

None.

B6.1.14 VMRS

Move to ARM core register from Advanced SIMD and VFP extension System Register moves the value of an extension system register to a general-purpose register.

Encoding T1 / A1 VFPv2, VFPv3, Advanced SIMD

VMRS<c> <Rt>, <spec_reg>

15	14	13	12	11	10	9	8	7	6	5	4	3	2	1	0	15	14	13	12	11	10	9	8	7	6	5	4	3	2	1	0
1	1	1	0	1	1	1	0	1	1	1	1	reg			Rt			1	0	1	0	(0)	(0)	(0)	1	(0)	(0)	(0)	(0)		
31	30	29	28	27	26	25	24	23	22	21	20	19	18	17	16	15	14	13	12	11	10	9	8	7	6	5	4	3	2	1	0
cond			1	1	1	0	1	1	1	1	reg			Rt			1	0	1	0	(0)	(0)	(0)	1	(0)	(0)	(0)	(0)			

t = UInt(Rt);

if t == 13 && CurrentInstrSet() != InstrSet_ARM then UNPREDICTABLE;

if t == 15 && reg != '0001' then UNPREDICTABLE;

Assembler syntax

VMRS<c><q> <Rt>, <spec_reg>

where:

<c><q> See *Standard assembler syntax fields* on page A8-7.

<Rt> The destination ARM core register. This register can be R0-R14.

If <spec_reg> is FPSCR, it is also permitted to be APSR_nzcv, encoded as Rt = '1111'. This instruction transfers the FPSCR N, Z, C, and V flags to the APSR N, Z, C, and V flags.

<spec_reg> Is one of:

FPSID	reg = '0000'
FPSCR	reg = '0001'
MVFR1	reg = '0110'
MVFR0	reg = '0111'
FPEXC	reg = '1000'.

If the Common VFP subarchitecture is implemented, see *Subarchitecture additions to the VFP system registers* on page AppxB-15 for additional values of <spec_reg>.

The pre-UAL instruction FMSTAT is equivalent to VMRS APSR_nzcv, FPSCR.

Operation

```

if ConditionPassed() then
    EncodingSpecificOperations();
    if reg == '0001' then // FPSCR
        CheckVFPEEnabled(TRUE); SerializeVFP(); VFPExcBarrier();
        if t == 15 then
            APSR.N = FPSCR.N; APSR.Z = FPSCR.Z; APSR.C = FPSCR.C; APSR.V = FPSCR.V;
        else
            R[t] = FPSCR;
    else // Non-FPSCR registers are privileged-only and not affected by FPEXC.EN
        CheckVFPEEnabled(FALSE);
        if !CurrentModeIsPrivileged() then UNDEFINED;
        case reg of
            when '0000' SerializeVFP(); R[t] = FPSID;
            // '0001' already dealt with above
            when '001x' UNPREDICTABLE;
            when '010x' UNPREDICTABLE;
            when '0110' SerializeVFP(); R[t] = MVFR1;
            when '0111' SerializeVFP(); R[t] = MVFR0;
            when '1000' SerializeVFP(); R[t] = FPEXC;
            otherwise SUBARCHITECTURE_DEFINED register access;

```

Exceptions

Undefined Instruction.

B6.1.15 VMSR

Move to Advanced SIMD and VFP extension System Register from ARM core register moves the value of a general-purpose register to a VFP system register.

Encoding T1 / A1 VFPv2, VFPv3, Advanced SIMD

VMSR<c> <spec_reg>, <Rt>

15	14	13	12	11	10	9	8	7	6	5	4	3	2	1	0	15	14	13	12	11	10	9	8	7	6	5	4	3	2	1	0
1	1	1	0	1	1	1	0	1	1	1	0	reg			Rt			1	0	1	0	(0)	(0)	(0)	1	(0)	(0)	(0)	(0)		
31	30	29	28	27	26	25	24	23	22	21	20	19	18	17	16	15	14	13	12	11	10	9	8	7	6	5	4	3	2	1	0
cond			1	1	1	0	1	1	1	0	reg			Rt			1	0	1	0	(0)	(0)	(0)	1	(0)	(0)	(0)	(0)			

t = UInt(Rt);

if t == 15 || (t == 13 && CurrentInstrSet() != InstrSet_ARM) then UNPREDICTABLE;

Assembler syntax

VMSR<c><q> <spec_reg>, <Rt>

where:

<c><q> See *Standard assembler syntax fields* on page A8-7.

<spec_reg> Is one of:
 FPSID reg = '0000'
 FPSCR reg = '0001'
 FPEXC reg = '1000'.

If the Common VFP subarchitecture is implemented, see *Subarchitecture additions to the VFP system registers* on page AppxB-15 for additional values of <spec_reg>.

<Rt> The general-purpose register to be transferred to <spec_reg>.

Operation

```

if ConditionPassed() then
  EncodingSpecificOperations();
  if reg == '0001' then // FPSCR
    CheckVFPEEnabled(TRUE); SerializeVFP(); VFPExcBarrier();
    FPSCR = R[t];
  else // Non-FPSCR registers are privileged-only and not affected by FPEXC.EN
    CheckVFPEEnabled(FALSE);
    if !CurrentModeIsPrivileged() then UNDEFINED;
    case reg of
      when '0000' SerializeVFP();
      // '0001' already dealt with above
      when '001x' UNPREDICTABLE;
      when '01xx' UNPREDICTABLE;
      when '1000' SerializeVFP(); FPEXC = R[t];
      otherwise SUBARCHITECTURE_DEFINED register access;

```

Exceptions

Undefined Instruction.

Part C

Debug Architecture

Chapter C1

Introduction to the ARM Debug Architecture

This chapter introduces part C of this manual, and the ARM Debug architecture. It contains the following sections:

- *Scope of part C of this manual* on page C1-2
- *About the ARM Debug architecture* on page C1-3
- *Security Extensions and debug* on page C1-8
- *Register interfaces* on page C1-9.

C1.1 Scope of part C of this manual

Part C of this manual defines the debug features of ARMv7. However, ARM recognizes that many debuggers require compatibility with previous versions of the ARM Debug architecture. Therefore, this part includes information about three versions of the ARM Debug architecture:

- v7 Debug
- v6.1 Debug
- v6 Debug

These three versions of the Debug architecture are introduced in *Major differences between the ARMv6 and ARMv7 Debug architectures* on page C1-7.

In part C of this manual:

- ARMv6 is used sometimes to refer to an implementation that includes either v6.1 Debug or v6 Debug.
- ARMv7 is used sometimes to refer to an implementation that includes v7 Debug.

Note

- v6.1 Debug and v6 Debug are two different versions of the Debug architecture for the ARMv6 architecture. They might be described as:

- ARMv6, v6.1 Debug
- ARMv6, v6 Debug.

Throughout this part the descriptions v6.1 Debug and v6 Debug are used, for brevity.

- Any processor that implements the ARMv7 architecture must implement v7 Debug. Information about v6.1 Debug and v6 Debug is given:
 - to enable developers to produce debuggers that are backwards compatible with these Debug architecture versions
 - as reference material for processors that implement the ARMv6 architecture.
-

C1.2 About the ARM Debug architecture

ARM processors implement two types of debug support:

Invasive debug All debug features that permit modification of processor state. For more information, see *Invasive debug*.

Non-invasive debug All debug features that permit data and program flow observation, especially trace support. For more information, see *Non-invasive debug* on page C1-5.

The following sections introduce invasive and non-invasive debug. *Summary of the ARM debug component descriptions* on page C1-7 gives a quick reference summary of the rest of this part of this manual.

C1.2.1 Invasive debug

The invasive debug component of the ARM Debug architecture is intended primarily for run-control debugging.

———— **Note** —————

In this part of this manual, invasive debug is often referred to simply as debug. For example, debug events, debug exceptions, and Debug state are all part of the invasive debug implementation.

The programmers' model can be used to manage and control *debug events*. Watchpoints and breakpoints are two examples of debug events. Debug events are described in Chapter C3 *Debug Events*.

You can configure the processor through the DBGDSCR into one of two debug-modes:

Monitor debug-mode

In Monitor debug-mode, a debug event causes a *debug exception* to occur:

- a debug exception that relates to instruction execution generates a Prefetch Abort exception
- a debug exception that relates to a data access generates a Data Abort exception.

Debug exceptions are described in Chapter C4 *Debug Exceptions*.

Halting debug-mode

In Halting debug-mode, a debug event causes the processor to enter a special *Debug state*. When the processor is in Debug state, the processor ceases to execute instructions from the program counter location, but is instead controlled through the external debug interface, in particular the *Instruction Transfer Register* (DBGITR). This enables an external agent, such as a debugger, to interrogate processor context, and control all subsequent instruction execution. Because the processor is stopped, it ignores the system and cannot service interrupts.

Debug state is described in Chapter C5 *Debug State*.

A debug solution can use a mixture of the two methods, for example to support an OS or RTOS with both:

- *Running System Debug* (RSD) using Monitor debug-mode
- Halting debug-mode support available as a fallback for system failure and boot time debug.

The architecture supports the ability to switch between these two debug-modes.

When no debug-mode is selected, debug is restricted to simple monitor solutions. These are usually ROM or Flash-based. Such a monitor might use standard system features, such as a UART or Ethernet connection, to communicate with a debug host. Alternatively, it might use the *Debug Communications Channel* (DCC) as an out-of-band communications channel to the host. This minimizes the debug requirement on system resources.

All versions of the Debug architecture provide a software interface that includes:

- a *Debug Identification Register* (DBGDIDR)
- status and control registers, including the *Debug Status and Control Register* (DBGDSCR)
- hardware breakpoint and watchpoint support
- the DCC.

In addition, the v7 Debug software interface includes reset, power-down and operating system debug support features.

The Debug architecture requires an external debug interface that supports access to the programmers' model.

This forms the basis of the *Debug Programmers' Model* (DPM) for ARMv6 and ARMv7.

Description of invasive debug features

The following chapters describe the invasive debug implementation:

- Chapter C2 *Invasive Debug Authentication*
- Chapter C3 *Debug Events*
- Chapter C4 *Debug Exceptions*
- Chapter C5 *Debug State*.

In addition, see:

- Chapter C6 *Debug Register Interfaces* for a description of the register interfaces to the debug components
- Chapter C10 *Debug Registers Reference* for descriptions of the registers used to configure and control debug operations
- Appendix A *Recommended External Debug Interface* for a description of the recommended external interface to the debug components.

C1.2.2 Non-invasive debug

Non-invasive debug includes all debug features that permit data and program flow to be observed, but that do not permit modification of the main processor state.

The v7 Debug architecture defines three areas of non-invasive debug:

- Instruction trace and, in some implementations, data trace. Trace support is an architecture extension typically implemented using a trace macrocell, see *Trace*.
- Sample-based profiling, see *Sample-based profiling* on page C1-6.
- Performance monitors, see *Performance monitors* on page C1-6.

A processor implementation might include other forms of non-invasive debug.

Chapter C7 *Non-invasive Debug Authentication* describes the authentication of non-invasive debug operations.

Trace

Trace support is an architecture extension. This manual describes such an extension as a trace macrocell. A trace macrocell constructs a real-time trace stream corresponding to the operation of the processor. It is IMPLEMENTATION DEFINED whether the trace stream is:

- stored locally in an *Embedded Trace Buffer (ETB)* for independent download and analysis
- exported directly through a trace port to a *Trace Port Analyzer (TPA)* and its associated host based trace debug tools.

Typically, use of a trace macrocell is non-invasive. Development tools can connect to the trace macrocell, configure it, capture trace and download the trace without affecting the operation of the processor in any way. A trace macrocell provides an enhanced level of runtime system observation and debug granularity. It is particularly useful in cases where:

- Stopping the processor affects the behavior of the system.
- There is insufficient state visible in a system by the time a problem is detected to be able to determine its cause. Trace provides a mechanism for system logging and back tracing of faults.

Trace might also be used to perform analysis of code running on the processor, such as performance analysis or code coverage analysis.

Typically, a trace architecture defines:

- the trace macrocell programmers' model
- permitted trace protocol formats
- the physical trace port connector.

The following documents define the ARM trace architectures:

- *Embedded Trace Macrocell Architecture Specification*
- *CoreSight Program Flow Trace Architecture Specification*.

The ARM trace architectures have a common identification mechanism. This means development tools can detect which architecture is implemented.

Sample-based profiling

Sample-based profiling is an optional non-invasive component of the Debug architecture, that enables debug software to profile a program. For more information, see Chapter C8 *Sample-based Profiling*.

Performance monitors

Performance monitors were implemented in several processors before ARMv7, but before ARMv7 they did not form part of the architecture. The ARMv7 form of the monitors, described here, follows those implementations with minor modifications to enable future expansion.

The basic form of the performance monitors is:

- A cycle counter, with the ability to count every cycle or every sixty-fourth cycle.
- A number of event counters. The event counted by each counter is programmable:
 - Previous implementations provided up to four counters
 - In ARMv7, space is provided for up to 31 counters. The actual number of counters is IMPLEMENTATION DEFINED, and an identification mechanism is provided.
- Controls for
 - enabling and resetting counters
 - flagging overflows
 - enabling interrupts on overflow.

The cycle counter can be enabled independently from the event counters.

The set of events that can be monitored is divided into:

- events that are likely to be consistent across many microarchitectures
- other events, that are likely to be implementation specific.

As a result, the architecture defines a common set of events to be used across many microarchitectures, and a large space reserved for IMPLEMENTATION DEFINED events. The full set of events for any given implementation is IMPLEMENTATION DEFINED. There is no requirement to implement any of the common set of events, but the numbers allocated for the common set of events must not be used except as defined.

Chapter C9 *Performance Monitors* describes the performance monitors.

C1.2.3 Major differences between the ARMv6 and ARMv7 Debug architectures

ARMv6 is the first version of the ARM architecture to include debug. The introduction of the ARM architecture Security Extensions extended the ARMv6 Debug architecture:

- ARMv6 processors without the Security Extensions implement v6 Debug
- ARMv6 processors with the Security Extensions implement v6.1 Debug.

ARMv7 introduces additional extensions to support developments in the debug environment.

The main change in the Debug architecture is the specification of new forms of external debug interface. ARMv6 Debug does not require a particular debug interface, but can be implemented with access from a JTAG interface as defined in *IEEE Standard Test Access Port and Boundary Scan Architecture (JTAG)*. However, systems such as the ARM CoreSight™ architecture require changes in the debug interface. For more information about the CoreSight architecture see the *CoreSight Architecture Specification*. ARMv7 Debug addresses some of the aims of the CoreSight architecture, such as a more system-centric view of debug, and improved debug of powered-down systems.

v7 Debug also introduces an architecture extension to provide performance monitors.

C1.2.4 Summary of the ARM debug component descriptions

Table C1-1 shows the main components of v7 Debug, and where they are described.

Table C1-1 v7 Debug subarchitectures

Component	Status	Type	Reference
Run-control Debug	Required	Invasive	Chapter C2 <i>Invasive Debug Authentication</i>
			Chapter C3 <i>Debug Events</i>
			Chapter C4 <i>Debug Exceptions</i>
			Chapter C5 <i>Debug State</i>
			Chapter C6 <i>Debug Register Interfaces</i>
Trace	Optional	Non-invasive ^a	<i>Trace</i> on page C1-5
Sample-based profiling	Optional	Non-invasive ^a	Chapter C8 <i>Sample-based Profiling</i>
Performance monitors	Optional	Non-invasive ^a	Chapter C9 <i>Performance Monitors</i>

a. For information about authentication of these components see Chapter C7 *Non-invasive Debug Authentication*.

For more information, see:

- Chapter C10 *Debug Registers Reference*
- Appendix A *Recommended External Debug Interface*.

C1.3 Security Extensions and debug

Security Extensions debug enables you to *not permit* invasive debug events and non-invasive debug operations independently in either:

- In all processor modes in Secure state.
- In Secure privileged modes but not in Secure User mode. In v7 Debug, for invasive debug events that cause entry to Debug state:
 - support for not permitting these events is optional
 - if an implementation does support not permitting these events the use of them is deprecated.

This is controlled by two control bits in the Secure Debug Enable Register and, in the recommended external debug interface, four input signals:

- the *Secure User Invasive Debug Enable* bit, **SDER.SUIDEN**
- the *Secure User Non-invasive Debug Enable* bit, **SDER.SUNIDEN**
- in the recommended external debug interface:
 - the *Debug Enable* signal, **DBGEN**
 - the *Non-Invasive Debug Enable* signal, **NIDEN**
 - the *Secure Privileged Invasive Debug Enable* signal, **SPIDEN**
 - the *Secure Privileged Non-Invasive Debug Enable* signal, **SPNIDEN**.

For more information, see:

- Chapter C2 *Invasive Debug Authentication*
- Chapter C7 *Non-invasive Debug Authentication*
- *c1, Secure Debug Enable Register (SDER)* on page B3-108 for details of the **SUIDEN** and **SUNIDEN** control bits
- *Authentication signals* on page AppxA-3 for details of the **DBGEN**, **NIDEN**, **SPIDEN** and **SPNIDEN** signals.

C1.4 Register interfaces

This section gives a brief description of the different debug register interfaces defined by v7 Debug. The most important distinction is between:

- the external debug interface, that defines how an external debugger can access the v7 Debug resources
- the processor interface, that describes how an ARMv7 processor can access its own debug resources.

For v7 Debug, ARM recommends an external debug interface based on the *ARM Debug Interface v5 Architecture Specification (ADIV5)*. The most significant difference between ADIV5 and the interface recommended by v6 Debug and v6.1 Debug is that ADIV5 supports debug over power-down of the processor.

Although the ADIV5 interface is not required for compliance with ARMv7, the ARM RealView® tools require this interface to be implemented.

ADIV5 supports both a JTAG wire interface and a low pin-count *Serial Wire (SW)* interface. The RealView tools support either wire interface.

An ADIV5 interface enables a debug object, such as an ARMv7 processor, to abstract a set of resources as a memory-mapped peripheral. Accesses to debug resources are made as 32-bit read/write transfers. Power-down debug is supported by introducing the abstraction that accesses to certain resources can return an error response when they are unavailable, just as a memory-mapped peripheral can return a slave-generated error response in exceptional circumstances.

v7 Debug requires software executing on the processor to be able to access all debug registers. To provide access to a particular basic subset of debug registers, v7 Debug requires implementation of the Baseline Coprocessor 14 (CP14) Interface, see *The Baseline CP14 debug register interface* on page C6-32. To provide access to the rest of the debug registers v7 Debug permits one of two options:

- An Extended CP14 interface. This is similar to the requirement of v6 Debug and v6.1 Debug.
- A memory-mapped interface.

An implementation can include both of these options.

ARMv7 does not permit all combinations of debug, trace, and performance monitor register interfaces. There are three options for ARMv7 implementations, shown in Table C1-2 on page C1-10. In a number of cases an optional memory-mapped interface is permitted, indicated by brackets. ARM recommends that if the optional memory-mapped interface is implemented for either the debug interface or the trace interface then it is implemented for both of these interfaces.

Table C1-2 Options for interfacing to debug in ARMv7

Processor interface to debug registers	Processor interface to trace registers	Processor interface to performance monitor
Baseline CP14 + Memory-mapped	(Memory-mapped) ^a	CP15
Baseline CP14 + Extended CP14 (+ Memory-mapped) ^a	Memory-mapped) ^a	CP15
Baseline CP14 + Extended CP14 (+ Memory-mapped) ^a	CP14 (+ Memory-mapped) ^a	CP15

a. Interfaces shown in brackets are optional, see text for more information.

Chapter C2

Invasive Debug Authentication

This chapter describes the authentication controls on invasive debug operations. It contains the following section:

- *About invasive debug authentication* on page C2-2.

———— **Note** —————

The recommended external debug interface provides an authentication interface that controls both invasive debug and non-invasive debug, as described in *Authentication signals* on page AppxA-3. This chapter describes how you can use this interface to control invasive debug. For information about using the interface to control non-invasive debug see Chapter C7 *Non-invasive Debug Authentication*.

C2.1 About invasive debug authentication

Invasive debug can be enabled or disabled. If it is disabled the processor ignores all debug events except BKPT Instruction. This means that debug events other than the BKPT Instruction debug event do not cause the processor to enter Debug state or to take a debug exception.

In addition, if a processor implements the Security Extensions, invasive debug can be permitted or not permitted. When invasive debug is not permitted, all debug events are not permitted. When a debug event is not permitted:

- if the debug event is not a BKPT Instruction debug event then it is ignored
- if the debug event is a BKPT Instruction debug event then it causes a debug exception.

Note

The BKPT Instruction debug event is never ignored.

The difference between enabled and permitted is that whether a debug event is permitted depends on both the security state and the operating mode of the processor.

For debug events that cause entry to Debug state, *Secure User halting debug* refers to permitting these events in Secure User mode when invasive debug is not permitted in Secure privileged modes. The debug events that cause entry to Debug state are:

- Halting debug events
- if Halting debug-mode is selected, Software debug events.

Support for Secure User halting debug is required in v6.1 Debug. In v7 Debug it is IMPLEMENTATION DEFINED whether Secure User halting debug is supported. On an implementation that does not support Secure User halting debug the DBGDIDR.nSUHD_imp bit is RAO, see *Debug ID Register (DBGDIDR)* on page C10-3. ARM deprecates the use of Secure User halting debug.

If the Security Extensions are implemented, when invasive debug is not permitted in Secure privileged modes it must be possible to permit, in Secure User mode, the debug events that do not cause entry to Debug state. The debug events that do not cause entry to Debug state are Software debug events when Monitor debug-mode is selected.

Note

When the Security Extensions are implemented, the Debug architecture distinguishes between permitting invasive halting debug and permitting invasive non-halting debug. However, in Non-secure state and in Secure privileged modes whether a debug event is permitted does not depend on whether the event would cause entry to Debug state. Therefore, the distinction between permitting invasive halting debug and invasive non-halting debug applies only in Secure User mode.

When Secure User halting debug is supported, the processor can be configured so that both invasive halting debug and invasive non-halting debug are permitted in Secure User mode when invasive debug is not permitted in Secure privileged modes. Therefore, the alternatives for when a debug event is permitted are:

- in all processor modes, in both Secure and Non-secure security states
- only in Non-secure state

- in Non-secure state and also in Secure User mode.

When Secure User halting debug is not supported, the processor can be configured only so that invasive non-halting debug is permitted in Secure User mode when invasive debug is not permitted in Secure privileged modes. Any debug event that would cause entry to Debug state is ignored, unless it is a BKPT Instruction debug event. Therefore, the alternatives for when a debug event is permitted are:

- in all processor modes, in both Secure and Non-secure security states
- only in Non-secure state
- in Non-secure state and also, if it will not cause entry to Debug state, in Secure User mode.

In v6.1 Debug and v7 Debug, invasive debug authentication can be controlled dynamically, meaning that whether a debug event is permitted can change while the processor is running, or while the processor is in Debug state. For more information, see *Generation of debug events* on page C3-40.

In v6 Debug, invasive debug authentication can be changed only while the processor is in reset.

In the recommended external debug interface, the signals that control the enabling and permitting of debug events are **DBGEN** and **SPIDEN**. **SPIDEN** is only implemented on processors that implement Security Extensions. See *Authentication signals* on page AppxA-3.

Part C of this manual assumes that the recommended external debug interface is implemented.

Note

- **DBGEN** and **SPIDEN** also control non-invasive debug, see *About non-invasive debug authentication* on page C7-2.
 - For more information about use of the authentication signals see *Changing the authentication signals* on page AppxA-4.
-

If **DBGEN** is LOW, all invasive debug is disabled.

On processors that do not implement Security Extensions, if **DBGEN** is HIGH, invasive debug is enabled and permitted in all modes, see Table C2-1:

Table C2-1 Invasive debug authentication, Security Extensions not implemented

DBGEN	Modes in which invasive debug is permitted
LOW	None. Invasive debug is disabled.
HIGH	All modes.

On processors that implement the Security Extensions, if both **DBGEN** and **SPIDEN** are HIGH, invasive debug is enabled and all debug events are permitted in all modes and in both Secure and Non-secure security states.

If **DBGEN** is HIGH and **SPIDEN** is LOW:

- invasive debug is enabled
- all debug events are permitted in the Non-secure state
- no debug events are permitted in Secure privileged modes.
- whether **invasive** debug is permitted in Secure User mode depends on:
 - the value of the **SDER.SUIDEN** bit, see *c1, Secure Debug Enable Register (SDER)* on page B3-108.
 - if Secure User halting debug is not supported, whether the debug event would cause entry to Debug state.

This is shown in Table C2-2.

Table C2-2 Invasive debug authentication, Security Extensions implemented

DBGEN^a	SPIDEN^a	SUIDEN^b	Mode	Security state	Invasive debug
LOW	X	X	Any	Either	Disabled
HIGH	LOW	0	Any	Non-secure	Enabled and permitted
				Secure	Enabled but not permitted
HIGH	LOW	1	Any	Non-secure	Enabled and permitted
			User	Secure	See note ^c
			Privileged	Secure	Enabled but not permitted
HIGH	HIGH	X	Any	Either	Enabled and permitted

a. Authentication signals, see *Authentication signals* on page AppxA-3.

b. **SDER.SUIDEN** bit, see *c1, Secure Debug Enable Register (SDER)* on page B3-108.

c. Invasive non-halting debug is permitted.

If Secure User halting debug is not supported then invasive halting debug is enabled but not permitted. Otherwise, invasive halting debug is enabled and permitted.

Note

Invasive and non-invasive debug authentication enable you to protect Secure processing from direct observation or invasion by an untrusted debugger. If you are designing a system you must be aware that security attacks can be aided by the invasive and non-invasive debug facilities. For example, Debug state or the **DBGDSCR.INTdis** register bit might be used for a denial of service attack, and the Non-secure performance monitors might be used to measure the side-effects of Secure processing on Non-secure code.

ARM recommends that where you are concerned about such attacks you disable invasive and non-invasive debug in all modes. However you must be aware of the limitations on the protection that debug authentication can provide, because similar attacks can be made by running malicious code on the processor in Non-secure state.

Chapter C3

Debug Events

This chapter describes debug events. Debug events trigger invasive debug operations. It contains the following sections:

- *About debug events* on page C3-2
- *Software debug events* on page C3-5
- *Halting debug events* on page C3-38
- *Generation of debug events* on page C3-40
- *Debug event prioritization* on page C3-43.

C3.1 About debug events

A debug event can be either:

- A Software debug event, see *Software debug events* on page C3-5
- A Halting debug event, see *Halting debug events* on page C3-38.

A processor responds to a debug event in one of the following ways:

- ignores the debug event
- takes a debug exception, see Chapter C4 *Debug Exceptions*
- enters Debug state, see Chapter C5 *Debug State*.

The response depends on the configuration. This is shown in Table C3-1 and in:

- Figure C3-1 on page C3-3 for v7 Debug
- Figure C3-2 on page C3-4 for v6 Debug and v6.1 Debug.

Table C3-1 Processor behavior on debug events

Configuration		Behavior, for specified debug event			Debug-mode selected and enabled
Enabled and permitted ^a	DBGDSCR [15:14] ^b	BKPT Instruction debug event	Other Software debug event	Halting debug event	
No	xx ^c	Debug exception ^d	Ignore	Ignore ^e	Disabled or not permitted
Yes	00	Debug exception ^d	Ignore	Debug state entry ^f	None
Yes	x1	Debug state entry	Debug state entry	Debug state entry	Halting
Yes	10	Debug exception	Debug exception or UNPREDICTABLE ^g	Debug state entry ^f	Monitor

- a. Invasive debug is enabled and the debug event is permitted. Whether a debug event is permitted might depend on the type of debug event as well as the configuration of the processor, see Chapter C2 *Invasive Debug Authentication*.
- b. See *Debug Status and Control Register (DBGDSCR)* on page C10-10.
- c. The value of DBGDSCR[15:14] is ignored when invasive debug is disabled or the debug event is not permitted. If debug is disabled these bits are RAZ.
- d. When debug is disabled or the debug event is not permitted, the BKPT instruction generates a debug exception rather than being ignored. The DBGDSCR, IFSR and IFAR are set as if a BKPT Instruction debug exception occurred. See *Effects of debug exceptions on CP15 registers and the DBGWFER* on page C4-4.
- e. The processor might enter Debug state later, see *Halting debug events* on page C3-38.
- f. In v6 Debug, it is IMPLEMENTATION DEFINED whether the processor enters Debug state or ignores the event.
- g. Be careful when programming debug events when Monitor debug-mode is selected and enabled, because certain conditions can lead to UNPREDICTABLE behavior, see *Unpredictable behavior on Software debug events* on page C3-24. In v6 Debug and v6.1 Debug, some events are ignored in this state.

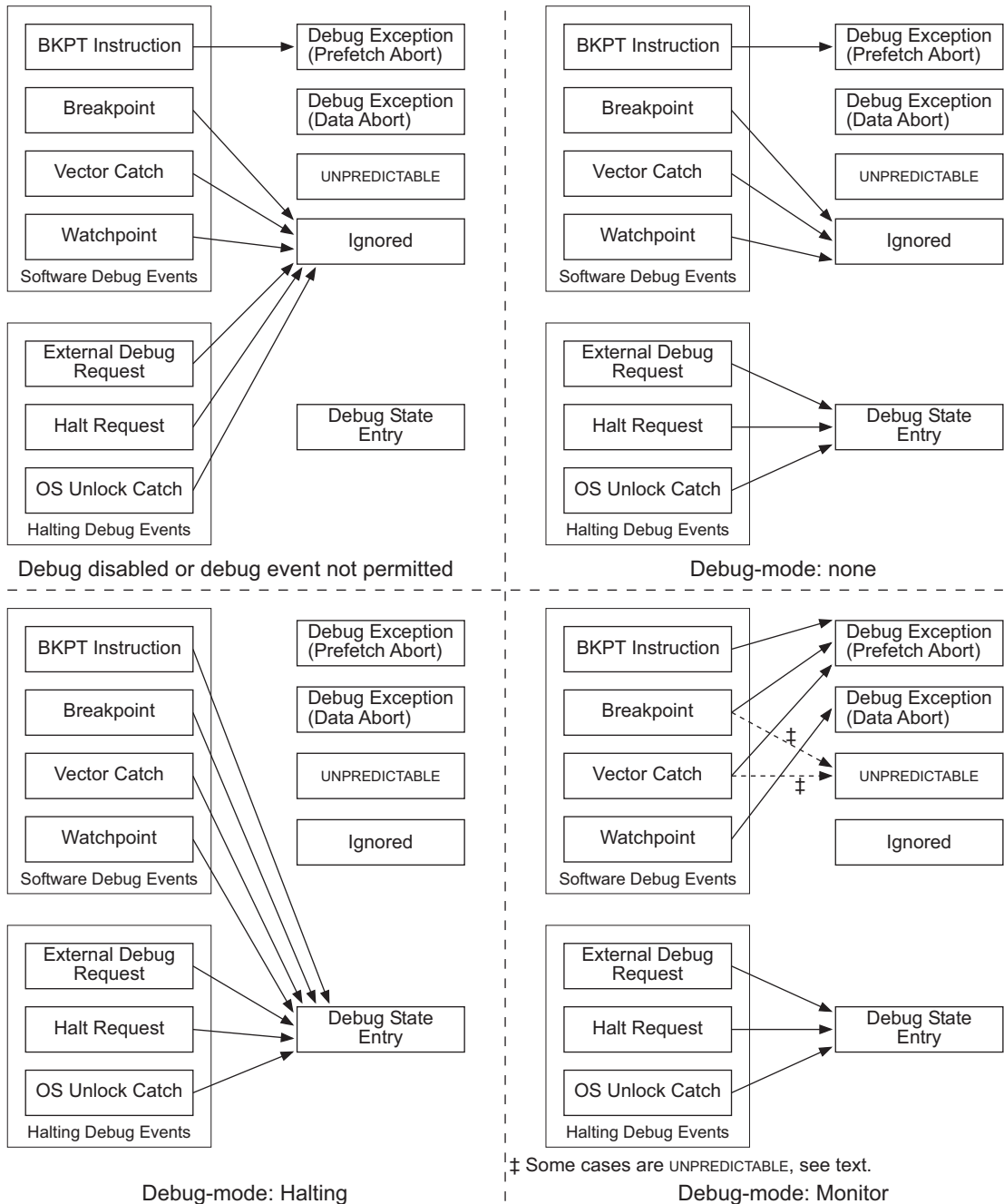

Figure C3-1 Processor behavior on debug events, for v7 Debug

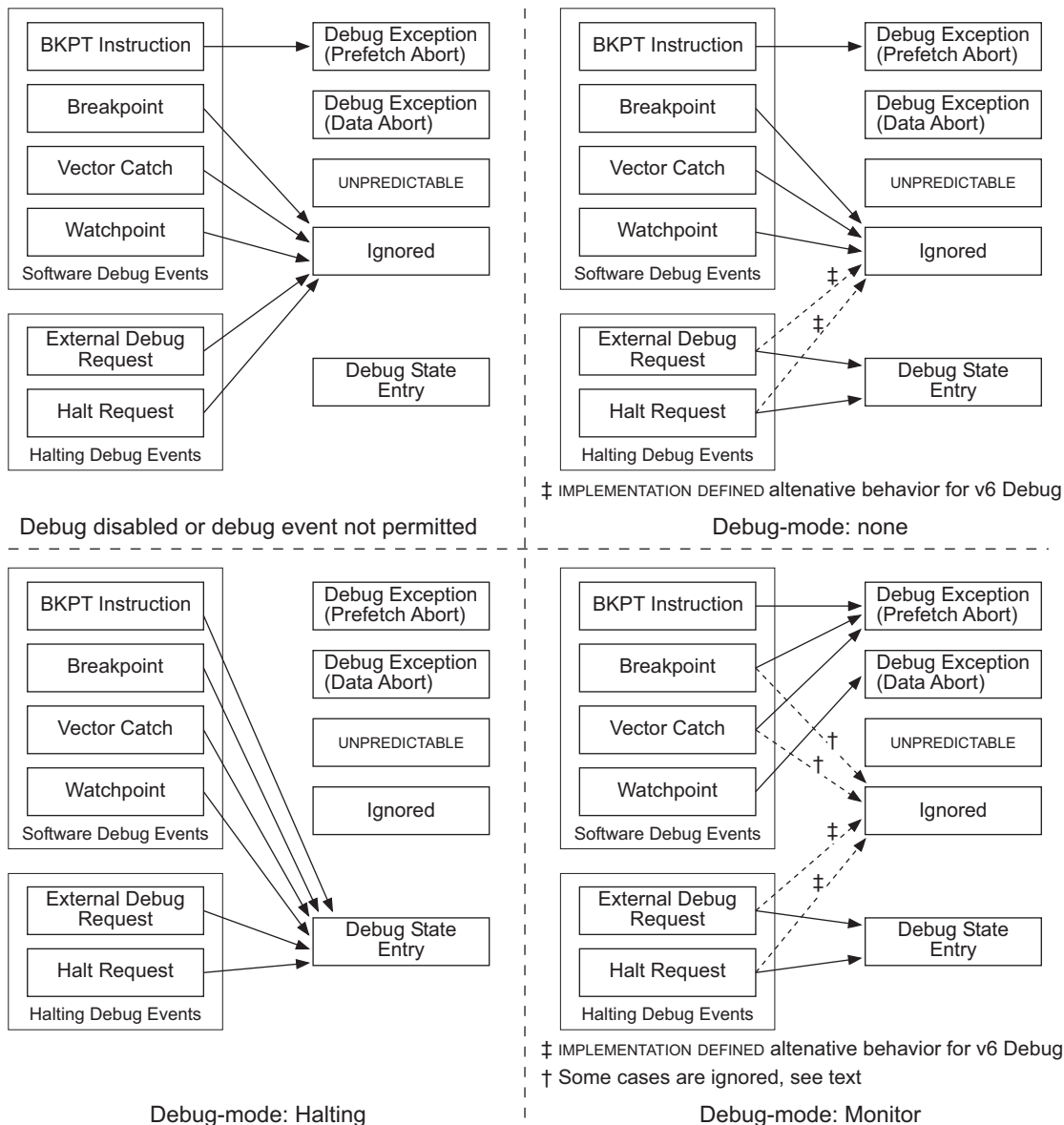

Figure C3-2 Processor behavior on debug events, for v6 Debug and v6.1 Debug

C3.2 Software debug events

A Software debug event can be any of the following:

- A Breakpoint debug event, see *Breakpoint debug events*
- A Watchpoint debug event, see *Watchpoint debug events* on page C3-15
- A BKPT Instruction debug event, see *BKPT Instruction debug events* on page C3-20
- A Vector Catch debug event, see *Vector Catch debug events* on page C3-20.

Memory addresses on page C3-23 describes the addresses used for generating Software debug events in different memory system implementations.

If Monitor debug-mode is selected and enabled, the behavior of certain types of Software debug event is UNPREDICTABLE. For more information, see *Unpredictable behavior on Software debug events* on page C3-24.

Pseudocode details of Software debug events on page C3-27 gives pseudocode for the operation of the Software debug events.

C3.2.1 Breakpoint debug events

A Breakpoint debug event is defined by a pair of registers described to as a *Breakpoint Register Pair* (BRP), comprising a *Breakpoint Control Register* (DBGBCR) and a *Breakpoint Value Register* (DBGBVR). BRPs, DBGBCRs, and DBGBVRs number upwards from 0, with BRPn comprising DBGBCRn and DBGBVRn. For details of the breakpoint registers see:

- *Breakpoint Control Registers (DBGBCR)* on page C10-49
- *Breakpoint Value Registers (DBGBVR)* on page C10-48.

The DBGDIDR.BRPs field specifies the number of BRPs implemented, see *Debug ID Register (DBGDIDR)* on page C10-3. The maximum number of BRPs is 16.

You can define a Breakpoint debug event:

- Based on comparison of an *Instruction Virtual Address* (IVA) with the value held in a DBGBVR. See *Memory addresses* on page C3-23 for the definition of an IVA.
- Based on comparison of the Context ID with the value held in a DBGBVR. Some BRPs might not support Context ID comparison. The DBGDIDR.CTX_CMPs field specifies the number of BRPs that support Context ID comparison, see *Debug ID Register (DBGDIDR)* on page C10-3.
- By linking a BRP to a second BRP, to define a single Breakpoint debug event. One pair includes an IVA for comparison, and the second pair includes a Context ID value.

In all cases, the DBGBCR defines some additional conditions that must be met for the BRP to generate a Breakpoint debug event, including whether the BRP is enabled.

The terms *hit* and *miss* are used to describe whether the conditions defined in the BRP are met:

- a hit occurs when the conditions are met
- a miss occurs when a condition is not met, meaning the processor does not generate a debug event.

The following sections describe Breakpoint debug events:

- *Generation of Breakpoint debug events*
- *Debug event generation conditions defined by the DBGBCR on page C3-7*
- *IVA comparisons for Debug event generation on page C3-8*
- *IVA comparisons and instruction length on page C3-10*
- *Context ID comparisons for Debug event generation on page C3-13*
- *Additional considerations for IVA mismatch breakpoints on page C3-13*
- *Additional conditions for linked BRPs on page C3-15.*

Generation of Breakpoint debug events

For each instruction in the program flow, the debug logic tests all the BRPs. For each BRP, the debug logic generates a Breakpoint debug event only if all of the following apply:

- When the BRP is tested, the conditions specified in the DBGBCR are met, see *Debug event generation conditions defined by the DBGBCR on page C3-7*.
- The comparison with the value in the DBGBVR is successful. When two BRPs are linked to define a single Breakpoint debug event, both comparisons must succeed. For more information see:
 - *IVA comparisons for Debug event generation on page C3-8*
 - *Context ID comparisons for Debug event generation on page C3-13*.
- The instruction is committed for execution.

———— **Note** —————

The processor must test for any possible Breakpoint debug events before it executes the instruction. The debug logic might test the BRPs when an instruction is prefetched. However, it must not generate a Breakpoint debug event if the instruction is not committed for execution.

—————

If all of these conditions are met, the debug logic generates the Breakpoint debug event regardless of whether the instruction passes its condition code test.

In ARMv6 and the ARMv7-A and ARMv7-R architecture profiles, the debug logic generates the debug event regardless of the type of instruction.

Breakpoint debug events are synchronous. That is, the debug event acts like an exception that cancels the breakpointed instruction.

When invasive debug is enabled and Monitor debug-mode is selected, if Breakpoint debug events are permitted a Breakpoint debug event generates a Prefetch Abort exception.

Debug event generation conditions defined by the DBGBCR

For each BRP, the DBGBCR defines some conditions for generating a Breakpoint debug event, using the following register fields:

Breakpoint enable

Controls whether this BRP is enabled.

Privileged mode control

Controls whether this BRP defines a Breakpoint debug event that can occur:

- only in User mode
- only in a privileged mode
- only in User, System or Supervisor modes
- in any mode.

Security state control

If the processor implements the Security Extensions, this field controls whether this BRP defines a Breakpoint debug event that can occur only in Secure state, only in Non-secure state, or in either security state.

For more information, including the differences in different versions of the Debug architecture, see *Breakpoint Control Registers (DBGBCR)* on page C10-49.

When two BRPs are linked to define a single Breakpoint debug event, the BRP that defines the IVA comparison also defines the privileged mode control and security state control, see *Additional conditions for linked BRPs* on page C3-15 for more information.

Other information in the DBGBCR

In addition to defining these conditions for generating a Breakpoint debug event, the DBGBCR controls the following:

- The DBGBCR meaning field defines the breakpoint type. The following sections describe all of the breakpoint types:
 - *IVA comparisons for Debug event generation* on page C3-8
 - *Context ID comparisons for Debug event generation* on page C3-13.
- The Linked BRP number field specifies whether the BRP is linked to another BRP. If this BRP is linked, this field gives the number of the linked BRP. For more information see *Additional conditions for linked BRPs* on page C3-15.
- For an IVA comparison, the DBGBCR defines a word-aligned address, and the Byte address select field specifies the bytes in that word that comprise the breakpointed instruction, see *IVA comparisons for Debug event generation* on page C3-8.
- For an IVA comparison in v7 Debug, the Address range mask field optionally specifies a bitmask that defines the low-order bits of the IVA and DBGBCR values that are excluded from the comparison, see *IVA comparisons for Debug event generation* on page C3-8.

Note

For IVA comparison in v7 Debug, you must use either byte address selection or address range masking to restrict the comparison made. However, you cannot use both at the same time.

IVA comparisons for Debug event generation

The result of an IVA comparison depends on the value in the DBGGBVR either matching or mismatching the IVA value. In each case, you can link the BRP to a second BRP that defines a Context ID comparison. This means that the breakpoint types that depend on an IVA comparison are:

- Unlinked IVA match
- Unlinked IVA mismatch
- Linked IVA match
- Linked IVA mismatch.

When the DBGBCR is programmed for one of these breakpoint types, the debug logic generates a Breakpoint debug event only if all the other conditions for the breakpoint are met, and the IVA comparison is successful. That is, all other conditions are met and, taking account of any masking:

- for an IVA match, the IVA value equals the value in the DBGGBVR
- for an IVA mismatch, the IVA value does not equal the value in the DBGGBVR.

In the linked cases, the debug logic generates a Breakpoint debug event only if all the other conditions for the breakpoint are met, the IVA comparison is successful, and the Context ID comparison in the linked BRP is successful, see *Context ID comparisons for Debug event generation* on page C3-13. See *Additional conditions for linked BRPs* on page C3-15 for more information.

All versions of the Debug architecture support byte address selection, to specify which bytes of the word addressed by DBGGBVR comprise the breakpointed instruction. v7 Debug supports an alternative bit masking scheme referred to as address range masking. The following subsections give more information about the IVA comparisons:

- *Condition for breakpoint generation on IVA match, without address range masking* on page C3-9
- *Condition for breakpoint generation on IVA mismatch, without address range masking* on page C3-9
- *Breakpoint address range masking behavior, v7 Debug* on page C3-9.

DBGGBVR values must be word-aligned, and DBGGBVR[1:0] are never used for IVA comparison. ARM instructions are always word-aligned, and therefore a DBGGBVR value can specify exactly the IVA of an ARM instruction. See *IVA comparisons and instruction length* on page C3-10 for more information about how the instruction length affects how you must define a breakpoint.

Note

- v6 Debug does not support IVA mismatch.
 - If it is supported, you can use IVA mismatch to generate a Breakpoint debug event when the processor executes an instruction other than the instruction indicated by the DBGGBVR. You can use this for single-stepping, or for breakpointing all instructions outside a range of instruction addresses.
-

Condition for breakpoint generation on IVA match, without address range masking

When BRPn is programmed for IVA match, without address range masking, and all other conditions for generating a breakpoint are met, a Breakpoint debug event is generated only if both:

- bits [31:2] of the IVA are equal to the value of bits [31:2] of DBGBVRn
- the Byte address select field, bits [8:5], of DBGBCRn is programmed for an IVA match for the current Instruction set state and IVA[1:0] value, see *Byte address selection behavior on IVA match or mismatch* on page C10-55.

Note

In v7 Debug, to perform IVA comparison without address range masking you must set DBGBCR[28:24], the Address range mask field, to zero.

Condition for breakpoint generation on IVA mismatch, without address range masking

When BRPn is programmed for IVA mismatch, without address range masking, and all other conditions for generating a breakpoint are met, a Breakpoint debug event is generated only if either:

- bits [31:2] of the IVA are not equal to the value of bits [31:2] of DBGBVRn
- the Byte address select field, bits [8:5], of DBGBCRn is programmed for an IVA mismatch for the current Instruction set state and IVA[1:0] value, see *Byte address selection behavior on IVA match or mismatch* on page C10-55.

Note

In v7 Debug, to perform IVA comparison without address range masking you must set DBGBCR[28:24], the Address range mask field, to zero.

Breakpoint address range masking behavior, v7 Debug

When BRPn is programmed for IVA matching, the comparison is masked using the value held in the Address range mask field, DBGBCRn[28:24].

You can use the Address range mask field when programming the BRP for IVA mismatch, that is, when DBGBCR[28:24] != 0b00000 and DBGBCR[22] == 1. In this case, the address comparison portion of breakpoint generation hits for all addresses outside the masked address region.

If an implementation does not support breakpoint address range masking, the Address range mask field is RAZ.

Note

There is no encoding for a full 32-bit mask. This mask would have the effect of setting a breakpoint that hits on every address comparison, and you can achieve this by setting:

- DBGBCR[22] to 1 to select an IVA mismatch
 - DBGBCR[8:5] to 0b0000.
-

To use address range masking, you must also set DBGBCR[8:5], the Byte address field, to 0b1111.

IVA comparisons and instruction length

An instruction set is *fixed-length* if all of its instructions have the same length, and *variable-length* otherwise. In a variable-length instruction set a single instruction comprises one or more units of memory.

The ARM instruction set is an example of a fixed-length instruction set. In the ARM instruction set the size of each instruction is one word, and ARM instructions are always word aligned.

The following are examples of variable-length instruction sets:

- The ThumbEE instruction set, and the Thumb instruction set from ARMv6T2 onwards. In these instruction sets an instruction comprises one or two halfwords.
- Java bytecodes. A single Java bytecode comprises one or more bytes.

Before ARMv6T2, an implementation can treat the Thumb instruction set as a fixed-length 16-bit instruction set, as described in *BL and BLX (immediate) instructions, before ARMv6T2* on page AppxG-4. An implementation that does this can permit an exception to be taken between the two halfwords of a BL or BLX (immediate) instruction.

In a variable-length instruction set, for an instruction consisting of more than one unit of memory, the first unit of the instruction is defined as the unit of the instruction with the lowest address in memory.

In a fixed-length instruction set, an instruction consists of a single unit of memory. This unit is also the first unit of the instruction.

Instruction length considerations depend on the Debug architecture version, as described in the following subsections:

- *Effect of instruction length in v7 Debug*
- *Effect of instruction length in v6 Debug and v6.1 Debug* on page C3-11.

IVA comparison programming examples on page C3-12 gives examples of Breakpoint programming, taking account of possible instruction length effects, for all versions of the Debug architecture.

Effect of instruction length in v7 Debug

In v7 Debug there are four types of IVA breakpoint:

- IVA match with no address range mask, described as a *regular* IVA breakpoint
- IVA mismatch with no address range mask, described as a *step-off* IVA breakpoint
- IVA match with an address range mask, described as an *included range* IVA breakpoint

- IVA mismatch with an address range mask, described as an *excluded range* IVA breakpoint

Note

Support for address range masks on breakpoints is IMPLEMENTATION DEFINED.

For all types of IVA breakpoint, if the conditions in the DBGBCR are met, and the instruction is committed for execution, the BRP generates a Breakpoint debug event if the required DBGBVR comparison, taking account of the byte address selection and any address range masking, hits for the first unit of the instruction.

Table C3-2 shows the conditions for Breakpoint debug event generation by an instruction that comprises more than one unit of memory, assuming that the conditions in the DBGBCR are met and that the instruction is committed for execution.

Table C3-2 Breakpoint debug event generation for instructions of more than one unit of memory

DBGBVR comparison result ^a :		IVA breakpoint type	Breakpoint debug event generated?
First unit ^b	Any subsequent unit ^b		
Hit	-	Any	Yes
Miss	Hit	Regular, included range, or excluded range	UNPREDICTABLE
		Step-off	No
Miss	Miss	Any	No

a. Taking account of the byte address selection and any address range masking.

b. Of the instruction whose IVA is being compared.

Effect of instruction length in v6 Debug and v6.1 Debug

If the conditions in the DBGBCR are met, and the instruction is committed for execution, the BRP generates a Breakpoint debug event if the required DBGBVR comparison, taking account of the byte address selection, hits for the first unit of the instruction.

In v6 Debug and v6.1 Debug, it is IMPLEMENTATION DEFINED whether an IVA comparison on an instruction memory unit other than the first unit, following a breakpoint miss on the first unit of the instruction, can cause a Breakpoint debug event.

For Java bytecodes, v6 Debug and v6.1 Debug specify that a BRP comparison on an operand does not generate a Breakpoint debug event. A Breakpoint debug is generated only if the BRP hits on the opcode.

For Java bytecodes the instruction memory unit is a byte, and the opcode is always the first byte of the instruction.

Note

- v6 Debug does not support IVA mismatch breakpoints.
 - v6.1 Debug and v6 Debug do not support address range masks on breakpoints.
-

IVA comparison programming examples

In all Debug architecture versions, a debugger must configure the BRP so that it matches on all bytes of the first unit of the instruction, otherwise the generation of Breakpoint debug events is UNPREDICTABLE.

Before ARMv6T2, on a processor that implements the Thumb instruction set and can take an exception between the two halfwords of a Thumb BL or BLX (immediate) instruction, a debugger must treat the two halfwords as separate instructions, and set breakpoints on both halfwords. This might require two BRPs.

Note

- To ensure compatibility across ARMv6 implementations, a debugger can always treat BL or BLX (immediate) as two instructions when debugging code on an ARMv6 processor before ARMv6T2.
 - The examples that follow include setting breakpoints on ThumbEE instructions. These are supported only in ARMv7.
-

For example, if BRPn and BRPm are two breakpoint register pairs, then:

- On any ARMv6 or ARMv7 processor:
 - To breakpoint on a Java bytecode at address 0x8001, the debugger must set DBGVRn to 0x8000 and DBGBCRn[8:5] to 0b0010.
 - To breakpoint on a 16-bit Thumb or ThumbEE instruction starting at address 0x8002, a debugger must set DBGVRn to 0x8000 and DBGBCRn[8:5] to 0b1100.
 - To breakpoint on an ARM instruction starting at address 0x8004, a debugger must set DBGVRn to 0x8004 and DBGBCRn[8:5] to 0b1111.
- On an ARMv7 or ARMv6T2 processor, a debugger sets breakpoints on a 32-bit Thumb instruction, or on a 16-bit or a 32-bit ThumbEE instruction, in exactly the same way as on a 16-bit Thumb instruction. For example:
 - To breakpoint on a 16-bit or a 32-bit Thumb or ThumbEE instruction starting at address 0x8000, the debugger must set DBGVRn to 0x8000 and DBGBCRn[8:5] to 0b0011. These are the settings for breakpointing on any Thumb or ThumbEE instruction, including BL and BLX (immediate).
- On an ARMv6 or ARMv6K processor:
 - To breakpoint on a Thumb BL or BLX instruction at address 0x8000, a debugger must set DBGVRn to 0x8000, and DBGBCRn[8:5] to 0b1111.
 - To breakpoint on a Thumb BL or BLX instruction at address 0x8002, a debugger must set DBGVRn to 0x8000, DBGVRm to 0x8004, DBGBCRn[8:5] to 0b1100, and DBGBCRm[8:5] to 0b0011.

Note

When programming DBGGBVR for IVA match or mismatch, the debugger must program DBGGBVR[1:0] to 0b00, otherwise Breakpoint debug event generation is UNPREDICTABLE.

Context ID comparisons for Debug event generation

A Context ID comparison depends on the value in the DBGGBVR matching the Context ID, held in the Context ID Register, when the instruction is committed for execution. The breakpoint types that depend on a Context ID comparison are:

- Unlinked Context ID match
- Linked Context ID match.

When the DBGBCR is programmed for one of these debug types, the debug logic generates a Breakpoint debug event only if all the other conditions for the breakpoint are met, and the Context ID equals the value in the DBGGBVR.

In the linked case, the BRP that is programmed for a Context ID match is linked to at least one of:

- a BRP programmed for Linked IVA match or mismatch
- a Watchpoint Register Pair (WRP) programmed for linked Data Virtual Address (DVA) match.

In the linked IVA cases, the debug logic generates a Breakpoint debug event only if all the other conditions for the breakpoint are met, the Context ID comparison is successful, and the IVA comparison in the linked BRP is successful, see *IVA comparisons for Debug event generation* on page C3-8. See *Additional conditions for linked BRPs* on page C3-15 for more information.

In the linked DVA case, the debug logic generates a Watchpoint debug event only if all the other conditions for the watchpoint are met, the Context ID comparison is successful, and the DVA comparison in the linked WRP is successful, See *Watchpoint debug events* on page C3-15 for more information.

Note

- You cannot define a Breakpoint debug event based on a Context ID mismatch.
- You can link a BRP programmed for linked Context ID match to any number of:
 - BRPs programmed for Linked IVA match or mismatch
 - WRPs programmed for Linked DVA match.

This means you can use a single BRP to define the Context ID match for multiple breakpoints and watchpoints.

Additional considerations for IVA mismatch breakpoints

The following subsections describe additional considerations for IVA mismatch breakpoints:

- *Interaction of IVA mismatch breakpoints with other breakpoints and Vector Catch* on page C3-14
- *Generation of IVA mismatch breakpoints on branch to self instructions* on page C3-14.

Interaction of IVA mismatch breakpoints with other breakpoints and Vector Catch

When a BRPn is programmed for IVA mismatch and does not generate a Breakpoint debug event because the general conditions specified in DBGBCRn are not met, this does not affect the generation of:

- Breakpoint debug events by other BRPs
- Vector Catch debug events.

Note

In this context, the general conditions specified in DBGBCR not being met means that at least one of the following applies:

- the BRP is not enabled
- the Privileged mode control bits of the DBGBCR do not match the mode of the processor
- DBGBCR is configured for linked Context ID matching but the linked BRP either is not enabled or does not match the current Context ID
- the Security Extensions are implemented, and the Security state control field of DBGBCR does not match the security state of the processor.

However, if the general conditions specified in DBGBCRn are met, and BRPn does not generate a Breakpoint debug event only because the IVA fails the comparison required for an IVA mismatch, then the failure of this comparison can affect the generation of other debug events:

- if any other BRP, BRPm, hits on its required comparison with the IVA and meets the general conditions specified in DBGBCRm, it is UNPREDICTABLE whether BRPm generates a Breakpoint debug event
- if the Vector Catch Register defines a Vector Catch that matches the IVA, it is UNPREDICTABLE whether a Vector Catch debug event is generated.

Generation of IVA mismatch breakpoints on branch to self instructions

This section describes the generation of Breakpoint debug events when the IVA of an instruction that branches to itself misses a BRP programmed for IVA mismatch, and all the general conditions specified in the DBGBCR are met. See the IVA mismatch column of Table C10-11 on page C10-56 for details of when an IVA mismatch comparison misses. In this case:

1. The first time the instruction is committed for execution the BRP does not generate a Breakpoint debug event.
2. Because the instruction branches to itself, if no exception is generated, the instruction is committed for execution again. On this and any subsequent execution, it is UNPREDICTABLE whether the BRP generates a Breakpoint debug event.

Note

Instructions that branch to themselves include:

- a branch instruction that specifies itself as the branch destination
 - a load instruction that loads the PC from a memory location that holds the address of that load instruction.
-

Additional conditions for linked BRPs

When you link two BRPs to define a single Linked IVA match or mismatch breakpoint, if BRP_n defines the IVA match or mismatch and BRP_m defines the Context ID match:

- for the DBGBCR fields described in *Debug event generation conditions defined by the DBGBCR* on page C3-7, you must program DBGBCR_n and DBGBCR_m as follows:
 - in DBGBCR_n, program the Security state control and Privileged mode control fields to define the required conditions for Debug event generation
 - in DBGBCR_m, program the Security state control field to 0b00, and the Privileged mode control field to 0b11
- you must program the Linked BRP number field:
 - of DBGBCR_n with the value of m
 - of DBGBCR_m to zero
- you must program the DBGBVR meaning field:
 - of DBGBCR_n for Linked IVA match or mismatch
 - of DBGBCR_m for Linked Context ID match
- BRP_m must support Context ID comparisons.

Breakpoint debug event generation is UNPREDICTABLE if you do not meet all these conditions.

You must also set the Breakpoint enable bits in DBGBCR_n and DBGBCR_m to 1, to enable both BRPs.

Note

If you fail to enable either or both of the BRPs, BRP_n never generates any Breakpoint debug events.

For more information see *Linked comparisons* on page C10-59

C3.2.2 Watchpoint debug events

A Watchpoint debug event is defined by a pair of registers described as a *Watchpoint Register Pair* (WRP), comprising a *Watchpoint Control Register* (DBGWCR) and a *Watchpoint Value Register* (DBGWVR). WRPs, DBGWCRs, and DBGWVRs number upwards from 0, with WRP_n comprising DBGWCR_n and DBGWVR_n. For details of the Watchpoint registers see:

- *Watchpoint Control Registers (DBGWCR)* on page C10-61

- *Watchpoint Value Registers (DBGWVR)* on page C10-60.

The DBGDIDR.WRPs field specifies the number of WRPs implemented, see *Debug ID Register (DBGDIDR)* on page C10-3.

A WRP can be linked to a BRP, to define a single watchpoint event. The WRP holds a virtual address for comparison, and the BRP holds a Context ID value. For more information, see *Linked comparisons* on page C10-59.

A Watchpoint debug event is defined based on comparisons of a *Data Virtual Address (DVA)* with the value held in a WVR. See *Memory addresses* on page C3-23 for the definition of a DVA.

For a given Watchpoint Register Pair, WRPn, a Watchpoint debug event occurs when all of the following are true:

- The watchpoint is enabled, in DBGWCRn.
- The DVA matches the value in DBGWVRn.
- When the processor tests the WRP, all the conditions of DBGWCRn are met.
- If linking is enabled in DBGWCRn, when the processor tests the WRP, the Linked Context ID matching BRP, BRPm, meets the following conditions:
 - the BRP is enabled, in DBGBCRm
 - the value held in the DBGBVRm matches the Context ID held in the CONTEXTIDR.

For more information about BRPs see *Breakpoint debug events* on page C3-5.

- The instruction that initiated the memory access is committed for execution. A Watchpoint debug event is generated only if the instruction passes its condition code check.

———— **Note** —————

A watchpoint match does not require the access to match exactly the watched address. A match is generated on any access to any watched byte or bytes. For example, a match is generated on an unaligned word access that includes a byte that is being watched, even when the watched byte is not in the same word as the start address of the unaligned word.

All instructions that are defined as memory access instructions can generate Watchpoint debug events. For information about which instructions are memory accesses see *Alphabetical list of instructions* on page A8-14. Watchpoint debug event generation can be conditional on whether the memory access is a load access or a store access.

For a Store-Exclusive instruction, if the target address of the instruction would generate a Watchpoint debug event, but the check of whether the Store-Exclusive operation has control of the exclusive monitors returns FALSE, then it is IMPLEMENTATION DEFINED whether the processor generates the Watchpoint debug event.

For each of the memory hint instructions, PLD and PLI, it is IMPLEMENTATION DEFINED whether the instruction generates Watchpoint debug events. If either or both of the PLD and PLI instructions normally generates Watchpoint debug events, the behavior must be:

- For the PLI instruction:
 - no watchpoint is generated in a situation where, if the instruction was a real fetch rather than a hint, the real fetch would generate a Prefetch Abort exception
 - in all other situations a Watchpoint debug event is generated.
- For the PLD instruction:
 - no watchpoint is generated in a situation where, if the instruction was a real memory access rather than a hint, the real memory access would generate a Data Abort exception
 - in all other situations a Watchpoint debug event is generated.
- When watchpoint generation is conditional on the type of memory access, a memory hint instruction is treated as generating a load access.

It is IMPLEMENTATION DEFINED whether the following cache maintenance operations generate Watchpoint debug events:

- Clean data or unified cache line by MVA to PoU, DCCMVAU
- Clean data or unified cache line by MVA to PoC, DCCMVAC
- Invalidate data or unified cache line by MVA to PoC, DCIMVAC
- Invalidate instruction cache line by MVA to PoU, ICIMVAU
- Clean and Invalidate data or unified cache line by MVA to PoC, DCCIMVAC.

When Watchpoint debug event generation by these cache maintenance operations is implemented, the behavior must be:

- the cache maintenance operation must generate a Watchpoint debug event on a DVA match, regardless of whether the data is stored in any cache
- when watchpoint generation is conditional on the type of memory access, a cache maintenance operation is treated as generating a store access.

For regular data accesses, the size of the access is considered when determining whether a watched byte is being accessed. The size of the access is IMPLEMENTATION DEFINED for:

- memory hint instructions, PLD and PLI
- cache maintenance operations.

Watchpoint debug events are precise and can be *synchronous* or *asynchronous*:

- a synchronous Watchpoint debug event acts like a synchronous abort exception on the memory access instruction itself
- an asynchronous Watchpoint debug event acts like a precise asynchronous abort exception that cancels a later instruction.

For more information, see *Synchronous and Asynchronous Watchpoint debug events* on page C3-18.

For the ordering of debug events, ARMv7 requires that:

- Regardless of the actual ordering of memory accesses, Watchpoint debug events must be taken in program order. See *Debug event prioritization* on page C3-43.
- Watchpoint debug events must behave as if the processor tested for any possible Watchpoint debug event before the memory access was observed, regardless of whether the Watchpoint debug event is synchronous or asynchronous. See *Generation of debug events* on page C3-40.

Synchronous and Asynchronous Watchpoint debug events

ARMv7 permits watchpoints to be either *synchronous* or *asynchronous*. An implementation can implement synchronous watchpoints, asynchronous watchpoints, or both. It is IMPLEMENTATION DEFINED under what circumstances a watchpoint is synchronous or asynchronous.

ARMv6 only permits asynchronous watchpoints.

Synchronous Watchpoint debug events

A synchronous Watchpoint debug event acts like a synchronous abort:

- The debug event occurs before any following instructions or exceptions have altered the state of the processor.
- The value in the base register for the memory access is not updated.

———— **Note** —————

The Base Updated Abort Model is not permitted in ARMv7.

- If the instruction was a register load, the data returned is marked as invalid and:
 - if the instruction was a single register load, the destination is not updated
 - if the instruction loaded multiple registers, the values in the destination registers, other than the PC and base register, are UNKNOWN.
- If the instruction is a coprocessor load, the values left in the coprocessor registers are UNKNOWN.
- If the instruction is a store, the content of the memory location written to is unchanged.

When invasive debug is enabled and Monitor debug-mode is selected, if Watchpoint debug events are permitted a synchronous Watchpoint debug event generates a synchronous Data Abort exception. On a synchronous Watchpoint debug event, the DBGDSCR.MOE field is set to Synchronous Watchpoint occurred.

When an instruction that causes multiple memory operations is addressing Device or Strongly-ordered memory, if a synchronous Watchpoint debug event is signaled by a memory operation other than the first operation of the instruction, the memory access rules might not be maintained. Examples of instructions that cause multiple memory operations are the LDM and LDC instructions.

For example, if the second memory operation of an STM instruction signals a synchronous Watchpoint debug event, then when the instruction is re-tried following processing of the debug event, the first memory operation is repeated. This behavior is not normally permitted for accesses to Device or Strongly-ordered memory.

To avoid this circumstance, debuggers must not set watchpoints on addresses in regions of Device or Strongly-ordered memory that might be accessed in this way. The address range masking features of watchpoints can be used to set a watchpoint on an entire region, ensuring the synchronous Watchpoint debug event is taken on the first operation of such an instruction.

Asynchronous Watchpoint debug events

An asynchronous Watchpoint debug event acts like a precise asynchronous abort. Its behavior is:

- The watchpointed instruction *must* have completed, and other instructions that followed it, in program order, might have completed. For more information, see *Recognizing asynchronous Watchpoint debug events*.
- The watchpoint *must* be taken before any exceptions that occur in program order after the watchpoint is triggered.
- All the registers written by the watchpointed instruction are updated.
- Any memory accessed by the watchpointed instruction is updated.

When invasive debug is enabled and Monitor debug-mode is selected, if Watchpoint debug events are permitted an asynchronous Watchpoint debug event generates a precise asynchronous Data Abort exception.

An asynchronous Watchpoint debug event is not an abort and is not affected by architectural rules about aborts, including the rules about external aborts and asynchronous aborts. An asynchronous Watchpoint debug event:

- is not affected by the SCR.EA bit
- is not ignored when the CPSR.A bit is set to 1.

On an asynchronous Watchpoint debug event, the DBGDSCR.MOE field is set to Asynchronous Watchpoint occurred.

Recognizing asynchronous Watchpoint debug events

When an instruction that consists of multiple memory operations is accessing Device or Strongly-ordered memory, and an asynchronous Watchpoint debug event is signaled by a memory operation other than the first operation of the instruction, the debug event *must not* cause Debug state entry or a debug exception until all the operations have completed. This ensures the memory access rules for Device and Strongly-ordered memory are preserved.

Examples of instructions that cause multiple memory operations are the LDM and LDC instructions.

Note

To understand why the architecture does not permit the asynchronous Watchpoint debug event to be taken before the watchpointed instruction completes, consider an LDM instruction accessing Device or Strongly-ordered memory, with an asynchronous Watchpoint debug event signaled after the first word of memory is accessed. If the debug event was taken immediately, the LDM would be re-executed on return from the event handler. This would cause a new access to the first word of memory, breaking the rule that, for Device or Strongly-ordered memory, each memory operation of an instruction is issued precisely once.

C3.2.3 BKPT Instruction debug events

A BKPT Instruction debug event occurs when a BKPT instruction is committed for execution. BKPT is an unconditional instruction.

BKPT Instruction debug events are synchronous. That is, the debug event acts like an exception that cancels the BKPT instruction.

For details of the BKPT instruction and its encodings in the ARM and Thumb instruction sets see *BKPT* on page A8-56.

C3.2.4 Vector Catch debug events

The Vector Catch Register (DBGVCR) controls Vector Catch debug events, see *Vector Catch Register (DBGVCR)* on page C10-67.

A Vector Catch debug event occurs when:

- The IVA of an instruction matches a vector address for the current security state.
See *Memory addresses* on page C3-23 for a definition of the IVA.
- When the processor tests for the possible vector catch, the corresponding bit of the DBGVCR is set to 1, indicating that vector catch is enabled.
- The instruction is committed for execution. The debug event is generated whether the instruction passes or fails its condition code check.

If all the conditions for a Vector Catch debug event are met, the processor generates the event regardless of the mode in which it is executing.

The processor must test for any possible Vector Catch debug events before it executes the instruction.

If the Security Extensions are not implemented the debug logic uses only one set of vector addresses to generate Vector Catch debug events, and these are called the *Local vector addresses*.

If the Security Extensions are implemented, the debug logic uses three sets of vector addresses to generate Vector Catch debug events:

- One set for exceptions taken in the Non-secure exception modes. These are called the *Non-secure Local vector addresses*.

- One set for exceptions taken in the Secure exception modes other than Monitor mode. These are called the *Secure Local vector addresses*.
- One set for exceptions taken in Monitor mode. These are called the *Monitor vector addresses*.

You enable vector catch independently for each of these vector addresses, by setting a bit in the DBGVCR to 1, see *Vector Catch Register (DBGVCR)* on page C10-67.

If the Security Extensions are not implemented, the debug logic determines whether to generate a Vector Catch debug event by comparing every instruction fetch with the Local vector addresses.

If the Security Extensions are implemented, the debug logic determines whether to generate a Vector Catch debug event by comparing every Secure instruction fetch with the Secure Local and Monitor vector addresses, and by comparing every Non-secure instruction fetch with the Non-secure Local vector addresses.

Note

Any instruction fetched from an exception vector address and committed for execution triggers a Vector Catch debug event if the appropriate bit in the DBGVCR is set to 1. Testing for possible Vector Catch debug events does not check whether the instruction is executed as a result of an exception entry.

Whether a Vector Catch debug event is generated for an instruction is UNPREDICTABLE if either:

- The exception vector address is word-aligned and one of the following applies:
 - the first unit of the instruction is in the word at the exception vector address but is not at the exception vector address
 - the first unit of the instruction is not in the word at the exception vector address but another unit of the instruction is in that word.

This can occur when the processor is executing a variable-length instruction set, that is, in Thumb, ThumbEE or Jazelle state.

- The exception vector address is not word-aligned but is halfword-aligned and one of the following applies:
 - The first unit of the instruction is in the halfword at the exception vector address but is not at the exception vector address. This can occur only in Jazelle state, where instructions consist of one or more byte-sized units.
 - The first unit of the instruction includes the halfword at the exception vector address but is not at the exception vector address. This can occur only in ARM state, where all instructions are a single word and are word-aligned.
 - The first unit of the instruction is not in the halfword at the exception vector address but another unit of the instruction is in that halfword. This can occur in variable-length instruction set states, that is, in Thumb, ThumbEE or Jazelle state.

Note

Normally, exception vector addresses must be word-aligned. However, when `SCTLR.VE == 1`, enabling vectored interrupt support, the exception vector address for one or both of the IRQ and FIQ vectors might not be word-aligned. Support for exception vector addresses that are not word-aligned is IMPLEMENTATION DEFINED, see *Vectored interrupt support* on page B1-32.

If Monitor debug-mode is selected and enabled, and the vector is either the Prefetch Abort vector or the Data Abort vector, the debug event is:

- UNPREDICTABLE in v7 Debug
- ignored in v6 Debug and v6.1 Debug.

Vector Catch debug events are synchronous. That is, the debug event acts like an exception that cancels the instruction at the caught vector. When invasive debug is enabled and Monitor debug-mode is selected, if Vector Catch debug events are permitted a Vector Catch debug event generates a Prefetch Abort exception. For more information, see *Generation of debug events* on page C3-40.

Note

A Vector Catch debug event is taken only when the instruction is committed for execution and therefore might not be taken if another exception occurs, see *Debug event prioritization* on page C3-43.

For more information, see *Vector Catch Register (DBGVCR)* on page C10-67.

Vector catch debug events and vectored interrupt support

The ARM architecture provides support for vectored interrupts, where an interrupt controller provides the interrupt vector address directly to the processor. The mechanism for defining the vectors is IMPLEMENTATION DEFINED. You enable the use of vectored interrupts by setting the `SCTLR.VE` bit to 1. For more information see *Vectored interrupt support* on page B1-32.

Vectored interrupt support affects Vector Catch debug event generation for the IRQ and FIQ exception vectors. These two vectors are described as the *interrupt vectors*. The details of Vector Catch debug event generation on the interrupt vectors depend on whether the Security Extensions are implemented:

If the Security Extensions are not implemented

- If the `SCTLR.VE` bit is set to 0, then the Local vector addresses for IRQ and FIQ vector catch are determined by the exception base address.
- If the `SCTLR.VE` bit is set to 1, then the Local vector address for an IRQ or FIQ vector catch is the interrupt vector address supplied by the interrupt controller on taking the interrupt.

If the Security Extensions are implemented

The Secure Local and Non-secure Local vector addresses for IRQ and FIQ vector catch are determined by the appropriate banked copy of the `SCTRL2VE` bit:

- If the `SCTRL2VE` bit is set to 0, then the corresponding Local vector addresses for IRQ and FIQ vector catch are determined by the banked exception base address.
- If the `SCTRL2VE` bit is set to 1, then for each of IRQ and FIQ vector catch:
 - if the interrupt is taken in Secure or Non-Secure IRQ mode or FIQ mode, then the corresponding Local vector address is the interrupt vector address supplied by the interrupt controller on taking the interrupt.
 - if the interrupt is taken in Monitor mode, then it is IMPLEMENTATION DEFINED whether the IRQ and FIQ Vector Catch debug events generated from the Local vector addresses can occur, and if they can occur the Secure and Non-secure Local vector addresses for the vector catches are IMPLEMENTATION DEFINED.

The Monitor vector addresses for IRQ and FIQ vector catch are determined by the Monitor exception base address.

When the Vector Catch debug logic uses addresses supplied by the interrupt controller, then:

- if the interrupt controller has not supplied an interrupt address to the processor since vectored interrupt support was enabled then no Vector Catch debug events using Local vector addresses are generated
- ~~if Vector Catch debug events were not enabled when the interrupt controller supplied a vector address to the processor, but have been enabled since, an implementation must consistently either:~~
 - ~~generate a Vector Catch debug event if the IVA of an instruction matches the Local vector address~~
 - ~~not generate Vector Catch debug events using any Local vector address.~~

C3.2.5 Memory addresses

On processors that implement the *Virtual Memory System Architecture* (VMSA), and also implement the *Fast Context Switch Extension* (FCSE):

- It is IMPLEMENTATION DEFINED whether the *Instruction Virtual Address* (IVA) used in generating Breakpoint debug events is the *Modified Virtual Address* (MVA) or *Virtual Address* (VA) of the instruction.
- It is IMPLEMENTATION DEFINED whether the *Data Virtual Address* (DVA) used in generating Watchpoint debug events is the MVA or VA of the data access.
- The IVA used in generating Vector Catch debug events is always the VA of the instruction.
- The *Watchpoint Fault Address Register* (DBGWFAR) reads a VA plus an offset that depends on the processor instruction set state.
- The *Program Counter Sampling Register* (DBGPCSR), if implemented, reads a VA plus an offset that depends on the processor instruction set state.

Note

The FCSE is optional in ARMv7, and ARM deprecates use of the FCSE.

On processors that implement the VMSA, and do not implement the FCSE:

- The IVA used in generating Breakpoint debug events is the VA of the instruction.
- The DVA used in generating Watchpoint debug events is the VA of the data access.
- The IVA used in generating Vector Catch debug events is the VA of the instruction.
- The DBGWFAR reads a VA plus an offset that depends on the processor instruction set state.
- The DBGPCSR reads a VA plus an offset that depends on the processor instruction set state.

On processors that implement the *Protected Memory System Architecture* (PMSA), the Virtual Address is identical to the *Physical Address* (PA) and therefore:

- The IVA used in generating Breakpoint debug events is the PA of the instruction.
- The DVA used in generating Watchpoint debug events is the PA of the data access.
- The IVA used in generating Vector Catch debug events is the PA of the instruction.
- The DBGWFAR reads a PA plus an offset that depends on the processor instruction set state.
- The DBGPCSR reads a PA plus an offset that depends on the processor instruction set state.

For more information about the DBGWFAR, see:

- *Effects of debug exceptions on CP15 registers and the DBGWFAR* on page C4-4
- *Effect of entering Debug state on CP15 registers and the DBGWFAR* on page C5-4
- *Watchpoint Fault Address Register (DBGWFAR)* on page C10-28.

For more information about the DBGPCSR, see *Program Counter sampling* on page C8-2 and *Program Counter Sampling Register (DBGPCSR)* on page C10-38.

C3.2.6 UNPREDICTABLE behavior on Software debug events

In ARMv6 the following events are ignored if Monitor debug-mode is configured, because they could lead to an unrecoverable state:

- Vector Catch debug events on the Prefetch Abort and Data Abort vectors
- Unlinked Context ID Breakpoint debug events, if the processor is running in a privileged mode
- Linked or Unlinked Instruction Virtual Address mismatch Breakpoint debug events, if the processor is running in a privileged mode.

In ARMv7, if Monitor debug-mode is configured the generation of the following events is UNPREDICTABLE and can lead to an unrecoverable state:

- Vector Catch debug events on the Prefetch Abort and Data Abort vectors
- Unlinked Context ID Breakpoint debug events that are configured to be generated in any mode, or to be generated only in privileged modes
- Linked or Unlinked Instruction Virtual Address mismatch Breakpoint debug events that are configured to be generated in any mode, or to be generated only in privileged modes.

When Monitor debug-mode is configured, debuggers must avoid these cases by restricting the programming of the debug event control registers:

- DBGVCR[28,27,12,11,4,3] must be programmed as zero, see *Vector Catch Register (DBGVCR)* on page C10-67.
- The permitted values of the Privileged Mode control bits, DBGBCR[2:1], must be restricted in the following cases:
 - if DBGBCR[22:20] is set to 0b010, selecting an Unlinked Context ID breakpoint
 - If DBGBCR[22:20] is set to 0b100 or 0b101, selecting an IVA mismatch breakpoint.

For these cases, DBGBCR[2:1] must be programmed to one of:

- 0b00, selecting match only in User, Supervisor or System mode
- 0b10, selecting match only in User mode.

See *Debug exceptions in abort handlers* for additional points that must be considered before using the 0b00 setting.

For details of programming the DBGBCR see *Breakpoint Control Registers (DBGBCR)* on page C10-49.

If these restrictions are not followed, processor behavior on a resulting debug event is UNPREDICTABLE.

When the Security Extensions are implemented Vector Catch debug events on the Secure Monitor Call vector are not ignored and are not UNPREDICTABLE. However, normally DBGVCR[10] is also programmed as zero, see *Monitor debug-mode vector catch on Secure Monitor Call* on page C3-26.

Debug exceptions in abort handlers

The previous section indicated that, in ARMv7, a debugger might set DBGBCR[2:1] to 0b00, match in User, Supervisor and System modes, to avoid the possibility of reaching an unrecoverable state in the Unlinked Context ID and IVA mismatch breakpoint cases when Monitor debug-mode is selected. However, DBGBCR[2:1] must only be programmed to 0b00 if you are confident that the abort handler will not switch to one of these modes before saving context that might be corrupted by an additional debug event. The context that might be corrupted by such an event includes LR_abt, SPSR_abt, IFAR, DFAR, and DFSR.

It is unlikely that an abort handler would switch to User mode to process an abort before saving these registers, so setting DBGBCR[2:1] to 0b10, match only in User mode, is safer.

Also, take care when setting a Breakpoint or BKPT Instruction debug event inside a Prefetch Abort or Data Abort handler, or when setting a Watchpoint debug event on a data address that might be accessed by any of these handlers.

In general, a user must only set Breakpoint or BKPT Instruction debug events inside an abort handler at a point after the context that would be corrupted by a debug event has been saved. Breakpoint debug events in code that might be run by an abort handler can be avoided by setting DBGBCR[2:1] to 0b00 or 0b01, as appropriate.

Watchpoint debug events in abort handlers can be avoided by setting DBGWCR[2:1] for the watchpoint to 0b10, match only unprivileged accesses, if the code being debugged is not running in a privileged mode.

If these guidelines are not followed, a debug event might occur before the handler has saved the context of the abort, causing the context to be overwritten. This loss of context results in UNPREDICTABLE software behavior. The context that might be corrupted by such an event includes LR_abt, SPSR_abt, IFAR, DFAR, and DFSR.

Debug events in the debug monitor

Because debug exceptions generate Data Abort or Prefetch Abort exceptions, the precautions outlined in the section *Debug exceptions in abort handlers* on page C3-25 also apply to debug monitors. The suggested settings for breakpoints and watchpoints that can avoid taking debug exceptions in a Data Abort handler can be used to avoid taking debug exceptions in the debug monitor.

In addition, particularly on ARMv7 processors that do not implement the Extended CP14 interface, and particularly those that implement synchronous Watchpoint debug events, when Monitor debug-mode is enabled debuggers must avoid:

- setting Watchpoint debug events on the addresses of debug registers
- setting Breakpoint and Vector Catch debug events on the addresses of instructions in the debug monitor.

In particular, it is unwise to set a watchpoint on the address of the Watchpoint Control Register (DBGWCR) for that watchpoint, or to set a breakpoint on the address of an instruction that disables the breakpoint.

The section *Generation of debug events* on page C3-40 identifies two problem cases:

- A write to the DBGWCR for a watchpoint set on the address of that DBGWCR, to disable that watchpoint, triggers the watchpoint.

In this case:

- if watchpoints are asynchronous, the write to the DBGWCR still takes place and the watchpoint is disabled. The debug software must then deal with the re-entrant debug exception.
 - if watchpoints are synchronous the value in the DBGWCR after the watchpoint is signaled is unchanged, and the debug event is left enabled.
- an instruction that disables a breakpoint on that instruction triggers the breakpoint.
In this case, the debug exception is taken before the debug event is disabled.

In both of these cases it might be impossible to recover.

Monitor debug-mode vector catch on Secure Monitor Call

Debuggers must be cautious about programming a Vector Catch debug event on the Secure Monitor Call (SMC) vector when Monitor debug-mode is configured. If such an event is programmed, the following sequence can occur:

1. Non-secure code executes an SMC instruction.

2. The processor takes the SMC exception, branching to the Monitor vector in Monitor mode. The SCR.NS bit is set to 1, indicating the SMC originated in the Non-secure state.
3. The Vector Catch debug event is taken. Although SCR.NS is set to 1, the processor is in the Secure state because it is in Monitor mode.
4. The processor jumps to the Secure Prefetch Abort vector, and sets SCR.NS to 0.

———— **Note** —————

Aborts taken in Secure state cause SCR.NS to be set to 0.

5. The abort handler at the Secure Prefetch Abort handler can tell a Vector Catch debug event occurred, and can determine the address of the SMC instruction from LR_mon. However, it cannot determine whether that is a Secure or Non-secure address.

Therefore, ARM recommends that you do not program a Vector Catch debug event on the SMC vector when Monitor debug-mode is enabled.

———— **Note** —————

This is not a security issue, because the sequence given here can only occur if **SPIDEN** is HIGH.

Possible effect of the Security Extensions on FIQ vector catch

When the Security Extensions are implemented, a debugger might need to consider the implications of the SCR on a Vector Catch event set on the FIQ vector, when the SCR is configured with both:

- the SCR.FW bit set to 0, so the CPSR.F bit cannot be modified in Non-secure state
- the SCR.FIQ bit set to 0, so that FIQs are handled in FIQ mode.

With this configuration, if an FIQ occurs in Non-secure state, the processor does not set CPSR.F to disable FIQs, and so the processor repeatedly takes the FIQ exception.

It might not be possible to debug this situation using the vector catch on FIQ because the instruction at the FIQ exception vector is never committed for execution and therefore the debug event never occurs.

C3.2.7 Pseudocode details of Software debug events

The following subsections give pseudocode details of Software debug events:

- *Debug events*
- *Breakpoints and Vector Catches* on page C3-28
- *Watchpoints* on page C3-35.

Debug events

The following functions cause the corresponding debug events to occur:

BKPTInstrDebugEvent()

```
BreakpointDebugEvent()
VectorCatchDebugEvent()
WatchpointDebugEvent()
```

If the debug event is not permitted, it is ignored by the processor.

Breakpoints and Vector Catches

If invasive debug is enabled, on each instruction the `Debug_CheckInstruction()` function checks for BRP and DBGVCR matches. If a match is found the function calls `BreakpointDebugEvent()` or `VectorCatchDebugEvent()`. If the debug event is not permitted, it is ignored by the processor.

On a simple sequential execution model, the `Debug_CheckInstruction()` call for an instruction occurs just before the Operation pseudocode for the instruction is executed, and any call it generates to `BreakpointDebugEvent()` or `VectorCatchDebugEvent()` must happen at that time. However, the architecture does not define when the checks for BRP and DBGVCR matches are made, other than that they must be made at or before that time. Therefore an implementation can perform the checks much earlier in an instruction pipeline, marking the instruction as breakpointed, and cause a marked instruction to call `BreakpointDebugEvent()` or `VectorCatchDebugEvent()` if and when it is about to execute.

The `BRPMatch()` function checks an individual BRP match, calling the `BRPLinkMatch()` function if necessary to check whether a linked BRP matches.

The `VCRMATCH()` function checks for a Vector Catch debug event. When vectored interrupt support is enabled, it uses variables to hold the IRQ and FIQ interrupt vector addresses supplied to the processor by the interrupt controller on taking an interrupt in IRQ mode or FIQ mode. These variables are updated by the `VCR_OnTakingInterrupt()` function, that is called each time the processor takes an IRQ or FIQ interrupt.

For all of these functions, between a context changing operation and an exception entry, exception return or explicit *Instruction Synchronization Barrier* (ISB) operation, it is UNPREDICTABLE whether the values of `CurrentModeIsPrivileged()`, `CPSR.M`, `CurrentInstrSet()`, `FindSecure()`, and the `CONTEXTIDR` used by `BRPMatch()`, `BRPLinkMatch()`, and `VCRMATCH()` are the old or the new values.

```
// Debug_CheckInstruction()
// =====

Debug_CheckInstruction(bits(32) address, integer length)

    // Do nothing if debug disabled.
    if DBGDSCR<15:14> == '00' then return;

    case CurrentInstrSet() of
        when InstrSet_ARM
            step = 4;
        when InstrSet_Thumb, InstrSet_ThumbEE
            step = 2;
        when InstrSet_Jazelle
            step = 1;
    length = length / step;

    vcr_match = FALSE;
    brp_match = FALSE;
```



```

// Each unit of the instruction is checked against the VCR and the BRPs. VCRMatch()
// and BRPMatch() might return UNKNOWN for units other than the first unit of the
// instruction, as in some cases the generation of Debug events is UNPREDICTABLE.
for W = 0 to length-1
    vcr_match = VCRMatch(address, W == 0) || vcr_match;

    // This code does not take into account the case where a mismatch breakpoint
    // does not match the address of an instruction but another breakpoint or
    // vector catch does match the instruction. In that situation, generation of
    // the Debug event is UNPREDICTABLE.
    for N = 0 to UInt(DBGDIDR.BRPs)
        brp_match = BRPMatch(N, address, W == 0) || brp_match;

    address = address + step;

// A suitable debug event occurs if there has been a BRP match or a VCR match. If
// both have occurred, just one debug event occurs, and its type is IMPLEMENTATION
// DEFINED.
if vcr_match || brp_match then
    if !vcr_match then BreakpointDebugEvent();
    elseif !brp_match then VectorCatchDebugEvent();
    else IMPLEMENTATION_DEFINED either BreakpointDebugEvent() or VectorCatchDebugEvent();

return;

// BRPMatch()
// =====

boolean BRPMatch(integer N, bits(32) address, boolean first)
    assert N <= UInt(DBGDIDR.BRPs);

    // If this breakpoint is not enabled, return immediately.
    if DBGBCR[N]<0> == '0' return FALSE;

    unk_match = FALSE;

    // Mode control match
    case DBGBCR[N]<2:1> of
        when '00'
            if UInt(DBGDIDR.Version) < 3 then
                UNPREDICTABLE;
            else
                case CPSR.M of
                    when '10000' mode_control_match = TRUE; // User mode
                    when '10011' mode_control_match = TRUE; // Supervisor mode
                    when '11111' mode_control_match = TRUE; // System mode
                    otherwise mode_control_match = FALSE; // Any other mode
        when '01' mode_control_match = CurrentModeIsPrivileged(); // Privileged mode
        when '10' mode_control_match = !CurrentModeIsPrivileged(); // Unprivileged mode
        when '11' mode_control_match = TRUE; // Any mode

    // Byte lane select
    case CurrentInstrSet() of

```

```

when InstrSet_ARM
    byte_select_match = (DBGBCR[N]<8:5> != '0000');
when InstrSet_Thumb, InstrSet_ThumbEE
    case address<1> of
        when '0'    byte_select_match = (DBGBCR[N]<6:5> != '00');
        when '1'    byte_select_match = (DBGBCR[N]<8:7> != '00');
when InstrSet_Jazelle
    case address<1:0> of
        when '00'   byte_select_match = (DBGBCR[N]<5> == '1');
        when '01'   byte_select_match = (DBGBCR[N]<6> == '1');
        when '10'   byte_select_match = (DBGBCR[N]<7> == '1');
        when '11'   byte_select_match = (DBGBCR[N]<8> == '1');

// Address mask
case DBGBCR[N]<28:24> of
    when '0000'
        // This implies no mask, but the byte address is always dealt with by
        // byte_select_match, so the mask always has the bottom two bits set.
        mask = ZeroExtend('11', 32);
    when '00001', '00010'
        UNPREDICTABLE;
    otherwise
        mask = ZeroExtend(Ones(UInt(DBGBCR[N]<28:24>)), 32);
        if DBGBCR[N]<8:5> != '1111' then unk_match = TRUE;

// Meaning of BVR
case DBGBCR[N]<22:20> of
    when '000' // Unlinked IVA match
        cmp_in = address; linked = FALSE; mismatch = FALSE; mon_debug_ok = TRUE;

    when '001' // Linked IVA match
        cmp_in = address; linked = TRUE; mismatch = FALSE; mon_debug_ok = TRUE;

    when '010' // Unlinked context ID match
        if N < UInt(DBGDIDR.BRPs) - UInt(DBGDIDR.CTX_CMPs) then UNPREDICTABLE;
        if DBGBCR[N]<8:5> != '1111' || DBGBCR[N]<28:24> != '0000' then unk_match = TRUE;
        mask = Zeros(32);
        cmp_in = CONTEXTIDR; linked = FALSE; mismatch = FALSE; mon_debug_ok = FALSE;

    when '011' // Linked context ID match (does not match directly, only via link)
        return FALSE;

    when '100' // Unlinked IVA mismatch
        if UInt(DBGDIDR.Version) < 2 then UNPREDICTABLE;
        cmp_in = address; linked = FALSE; mismatch = TRUE; mon_debug_ok = FALSE;

    when '101' // Linked IVA mismatch
        if UInt(DBGDIDR.Version) < 2 then UNPREDICTABLE;
        cmp_in = address; linked = TRUE; mismatch = TRUE; mon_debug_ok = FALSE;

    otherwise // Reserved
        unk_match = TRUE;

if !IsZero(DBGBVR[N] AND mask) then unk_match = TRUE;

```

```

BVR_match = byte_select_match && (cmp_in AND NOT(mask)) == DBGBVR[N];
if mismatch then BVR_match = !BVR_match;

// If this is not the first unit of the instruction and there is an address match, then
// the breakpoint match is UNPREDICTABLE, except in the "single-step" case where it is a
// mismatch breakpoint without a range set. If there is a match on the first unit of the
// instruction, that will override the UNKNOWN case here. In the single-step case, matches
// on the subsequent units of the instruction are ignored.
if BVR_match && !first then
    if mismatch && DBGBCR[N]<28:24> == '0000' then // Single-step case
        BVR_match = FALSE;
    else
        BVR_match = boolean UNKNOWN;

// Security state
case DBGBCR[N]<15:14> of
    when '00' secure_state_match = TRUE; // Any state (or no Security Extensions)
    when '01' secure_state_match = !IsSecure(); // Non-secure only
    when '10' secure_state_match = IsSecure(); // Secure only
    when '11' UNPREDICTABLE; // Reserved

match = mode_control_match && BVR_match && secure_state_match;

// If linked, check the linked BRP.
if linked then match = match && BRPLinkMatch(UInt(DBGBCR[N]<19:16>));
elsif DBGBCR[N]<19:16> != '0000' then unk_match = TRUE;

// When Monitor debug-mode is configured:
// * some types of event are ignored in v6 Debug and v6.1 Debug in privileged modes
// * some types of event are UNPREDICTABLE in v7 Debug.
if !mon_debug_ok && DBGDSCR<15:14> == '10' then
    if UInt(DBGDIDR.Version) < 3 then
        if CurrentModeIsPrivileged() then return FALSE;
    else
        if DBGBCR[N]<2:1> == '01' || DBGBCR[N]<2:1> == '11' then UNPREDICTABLE;

if unk_match then
    return boolean UNKNOWN;
else
    return match;

// BRPLinkMatch()
// =====

boolean BRPLinkMatch(integer M)
    assert M <= UInt(DBGDIDR.BRPs);

    if M < UInt(DBGDIDR.BRPs) - UInt(DBGDIDR.CTX_CMPs) then UNPREDICTABLE;

// If this breakpoint is not enabled, return immediately.
if DBGBCR[M]<0> == '0' return FALSE;

unk_match = FALSE;

```

```

if DBGBCR[M]<2:1> != '11' then unk_match = TRUE;
if DBGBCR[M]<8:5> != '1111' then unk_match = TRUE;
if DBGBCR[M]<15:14> != '00' then unk_match = TRUE;
if DBGBCR[M]<19:16> != '0000' then unk_match = TRUE;
if DBGBCR[M]<22:20> != '011' then unk_match = TRUE;
if DBGBCR[M]<28:24> != '00000' then unk_match = TRUE;

if unk_match then
    return boolean UNKNOWN;
else
    return (CONTEXTIDR == DBGBVR[M]);

// Variables used to record most recent interrupts of various types.

bits(32) VCR_Recent_IRQ_S;
bits(32) VCR_Recent_IRQ_NS;
bits(32) VCR_Recent_FIQ_S;
bits(32) VCR_Recent_FIQ_NS;
boolean VCR_Recent_IRQ_S_Valid;
boolean VCR_Recent_IRQ_NS_Valid;
boolean VCR_Recent_FIQ_S_Valid;
boolean VCR_Recent_FIQ_NS_Valid;

// VCR_OnTakingInterrupt()
// =====

VCR_OnTakingInterrupt(bits(32) vector, boolean FIQnIRQ)
    if SCTL.R.VE == '1' then
        if FIQnIRQ then
            if IsSecure() then
                if DBGVCR<7> == '0' || (HaveSecurityExt() && SCR.FIQ == '1') then
                    IMPLEMENTATION_DEFINED whether the variables are updated;
                else
                    VCR_Recent_FIQ_S = vector;
                    VCR_Recent_FIQ_S_Valid = TRUE;
            else
                if DBGVCR<31> == '0' || (HaveSecurityExt() && SCR.FIQ == '1') then
                    IMPLEMENTATION_DEFINED whether the variables are updated;
                else
                    VCR_Recent_FIQ_NS = vector;
                    VCR_Recent_FIQ_NS_Valid = TRUE;
        else
            if IsSecure() then
                if DBGVCR<6> == '0' || (HaveSecurityExt() && SCR.IRQ == '1') then
                    IMPLEMENTATION_DEFINED whether the variables are updated;
                else
                    VCR_Recent_IRQ_S = vector;
                    VCR_Recent_IRQ_S_Valid = TRUE;
            else
                if DBGVCR<30> == '0' || (HaveSecurityExt() && SCR.IRQ == '1') then
                    IMPLEMENTATION_DEFINED whether the variables are updated;
                else
                    VCR_Recent_IRQ_NS = vector;

```

```

        VCR_Recent_IRQ_NS_Valid = TRUE;

    return;

// VCRVectorMatch()
// =====
//
// The result of this function says whether iaddr and eaddr match for vector catch purposes:
// TRUE         if they definitely match
// boolean UNKNOWN if it is UNPREDICTABLE whether they match
// FALSE        if they definitely do not match

boolean VCRVectorMatch(bits(32) iaddr, boolean first, bits(32) eaddr)

    match = FALSE;
    unpred = FALSE;

    if eaddr<31:2> == iaddr<31:2> then
        if eaddr<1:0> == iaddr<1:0> then
            // Exact address match is a definite match if on the first unit of the instruction,
            // otherwise an UNPREDICTABLE match.
            if first then match = TRUE; else unpred = TRUE;
        else
            // Check for other cases of UNPREDICTABLE matches.
            case CurrentInstrSet() of
                when InstrSet_ARM
                    unpred = TRUE;
                when InstrSet_Thumb, InstrSet_ThumbEE
                    if iaddr<1> == eaddr<1> then unpred = TRUE;
                    if iaddr<1:0> == '10' && eaddr<1:0> == '00' then unpred = TRUE;
                when InstrSet_Jazelle
                    if eaddr<1:0> == '00' then unpred = TRUE;
                    if eaddr<1:0> == '10' && iaddr<1:0> == '11' then unpred = TRUE;

    if match then
        return TRUE;
    elseif unpred then
        return boolean UNKNOWN;
    else
        return FALSE;

// VCRMatch()
// =====

boolean VCRMatch(bits(32) address, boolean first)

    // Determine addresses for IRQ and FIQ comparisons.

    if SCTLR.VE == '0' then
        VCR_Recent_IRQ_S_Valid = FALSE; VCR_Recent_IRQ_NS_Valid = FALSE;
        VCR_Recent_FIQ_S_Valid = FALSE; VCR_Recent_FIQ_NS_Valid = FALSE;
        irq_addr = ExcVectorBase() + 24; irq_addr_v = TRUE;
        fiq_addr = ExcVectorBase() + 28; fiq_addr_v = TRUE;

```

```

else
    if IsSecure() then
        irq_addr = VCR_Recent_IRQ_S; irq_addr_v = VCR_Recent_IRQ_S_Valid;
        fiq_addr = VCR_Recent_FIQ_S; fiq_addr_v = VCR_Recent_FIQ_S_Valid;
    else
        irq_addr = VCR_Recent_IRQ_NS; irq_addr_v = VCR_Recent_IRQ_NS_Valid;
        fiq_addr = VCR_Recent_FIQ_NS; fiq_addr_v = VCR_Recent_FIQ_NS_Valid;

a_match = FALSE; // Boolean for a match on an abort vector
match = FALSE; // Boolean for a match on any other vector

// Check for non-monitor, non-reset matches, using DBGVCR<7:1> if no Security
// Extensions or in Secure state, or DBGVCR<31:25> if in Non-secure state.
start = if IsSecure() then 0 else 24;
if DBGVCR<start+1> == '1' then
    match = match || VCRVectorMatch(address, first, ExcVectorBase()+4);
if DBGVCR<start+2> == '1' then
    match = match || VCRVectorMatch(address, first, ExcVectorBase()+8);
if DBGVCR<start+3> == '1' then
    a_match = a_match || VCRVectorMatch(address, first, ExcVectorBase()+12);
if DBGVCR<start+4> == '1' then
    a_match = a_match || VCRVectorMatch(address, first, ExcVectorBase()+16);
if DBGVCR<start+6> == '1' then
    if HaveSecurityExt() && SCR.IRQ == '1' && SCTLR.VE == '1' then
        IMPLEMENTATION_DEFINED what test is made, if any;
    else if irq_addr_v then
        match = match || VCRVectorMatch(address, first, irq_addr);
if DBGVCR<start+7> == '1' then
    if HaveSecurityExt() && SCR.FIQ == '1' && SCTLR.VE == '1' then
        IMPLEMENTATION_DEFINED what test is made, if any;
    else if fiq_addr_v then
        match = match || VCRVectorMatch(address, first, fiq_addr);

// If we have the Security Extensions and are in Secure state, check for monitor matches.
if HaveSecurityExt() && IsSecure() then
    if DBGVCR<10> == '1' then
        match = match || VCRVectorMatch(address, first, MVBAR+8);
    if DBGVCR<11> == '1' then
        a_match = a_match || VCRVectorMatch(address, first, MVBAR+12);
    if DBGVCR<12> == '1' then
        a_match = a_match || VCRVectorMatch(address, first, MVBAR+16);
    if DBGVCR<14> == '1' then
        match = match || VCRVectorMatch(address, first, MVBAR+24);
    if DBGVCR<15> == '1' then
        match = match || VCRVectorMatch(address, first, MVBAR+28);

// Check for reset matches.
// In v7 Debug this check is made regardless of the security state.
// In v6 Debug and v6.1 Debug this check is only made in Secure state.
vector = if SCTLR.V == '1' then Ones(16):Zeros(16) else Zeros(32);
if DBGVCR<0> == '1' && (UInt(DBGDIDR.Version) >= 3 || IsSecure()) then
    match = match || VCRVectorMatch(address, first, vector);

```



```

// When Monitor debug-mode is configured, abort vector catches are ignored in v6 Debug
// and v6.1 Debug, but UNPREDICTABLE in v7 Debug.
if a_match && DBGDSCR<15:14> == '10' then
    if UInt(DBGDIDR.Version) < 3 then
        a_match = FALSE;
    else
        UNPREDICTABLE;

return match || a_match;

```

Watchpoints

If invasive debug is enabled, the `Debug_CheckDataAccess()` function checks WRP matches for each data access. If the implementation includes IMPLEMENTATION DEFINED support for watchpoint generation on memory hint operations, or on cache maintenance operations, the function also checks for WRP matches on the appropriate operations. If a match is found the function calls `WatchpointDebugEvent()`. If the debug event is not permitted, it is ignored by the processor.

On a simple sequential execution model:

- for a synchronous watchpoint, the `Debug_CheckDataAccess()` test is made before the data access
- for an asynchronous watchpoint, the `Debug_CheckDataAccess()` test is made after the data access.

For more information see *Synchronous and Asynchronous Watchpoint debug events* on page C3-18.

The `WRPMatch()` function checks an individual WRP match. In ARMv7, it is IMPLEMENTATION DEFINED whether WRP matches use eight byte lanes or four. The `WRPUsesEightByteLanes()` function returns TRUE if they use eight byte lanes and FALSE if they use four. Using eight byte lanes is permitted only in ARMv7.

```
boolean WRPUsesEightByteLanes()
```

For these functions the parameters `read`, `write`, `privileged` and `secure` are determined at the point the access is made, and not from the state of the processor at the point where `WRPMatch()` is executed. For swaps, `read = write = TRUE`.

```

// Debug_CheckDataAccess()
// =====

```

```
boolean Debug_CheckDataAccess(bits(32) address, integer size, boolean read,
                               boolean write, boolean privileged, boolean secure)
```

```

// Do nothing if debug disabled;
if DBGDSCR<15:14> == '00' then return;

match = FALSE;
// Each byte accessed by the data access is checked
for byte = address to address + size - 1
    for N = 0 to UInt(DBGDIDR.WRPs)
        if WRPMatch(N, byte, read, write, privileged, secure) then match = TRUE;

if match then WatchpointDebugEvent();
return;

```

```

// WRPMATCH()
// =====

boolean WRPMATCH(integer N, bits(32) address, boolean read, boolean write,
                 boolean privileged, boolean secure)
    assert N <= UInt(DBGIDR.WRPs);

// If watchpoint is not enabled, return immediately.
if DBGWCR[N]<0> == '0' return FALSE;

// Access privilege match
case DBGWCR[N]<2:1> of
    when '00' UNPREDICTABLE; // Reserved
    when '01' privilege_match = privileged; // Only privileged accesses
    when '10' privilege_match = !privileged; // Only unprivileged accesses
    when '11' privilege_match = TRUE; // Any access

// Load/Store access control match
case DBGWCR[N]<4:3> of
    when '00' UNPREDICTABLE; // Reserved
    when '01' load_store_match = read; // Only load, load exclusive or swap
    when '10' load_store_match = write; // Only store, store exclusive or swap
    when '11' load_store_match = TRUE; // All accesses

// Address match
case DBGWCR[N]<28:24> of
    when '0000' // No mask
        // If implementation uses 8 byte lanes, DBGWVR[N]<2> == '1' selects 4 byte lane
        // behavior.
        if DBGWVR[N]<2> == '1' then
            bits = 2;
            if DBGWCR[N]<12:9> != '0000' then UNPREDICTABLE;
        else
            bits = if WRPUSESEightByteLanes() then 3 else 2;
            mask = ZeroExtend(Ones(bits), 32);
            if !IsZero(DBGWVR[N]<1:0>) then UNPREDICTABLE;
            byte = UInt(address<bits-1:0>);
            WVR_match = ((address AND NOT(mask)) == DBGWVR[N]) && (DBGWCR[N]<5+byte> == '1');

    when '0001', '0010' // Reserved
        UNPREDICTABLE;

    otherwise // Masked address check
        mask = ZeroExtend(Ones(UInt(DBGWCR[N]<28:24>)), 32);
        if !IsZero(DBGWVR[N] AND mask) then UNPREDICTABLE;
        if DBGWCR[N]<8:5> != '1111' then UNPREDICTABLE;
        if WRPUSESEightByteLanes() && (DBGWCR[N]<12:9> != '1111') then UNPREDICTABLE;
        WVR_match = ((address AND NOT(mask)) == DBGWVR[N]);

// Security state
case DBGWCR[N]<15:14> of
    when '00' secure_state_match = TRUE; // Any access (or no Security Extensions)
    when '01' secure_state_match = !secure; // Only non-secure accesses

```



```
    when '10' secure_state_match = secure; // Only secure accesses
    when '11' UNPREDICTABLE; // Reserved

match = privilege_match && load_store_match && WVR_match && secure_state_match;

// Check for linking
linked = (DBGWCR[N]<22> == '1');
if linked then match = match && BRPLinkMatch(UInt(DBGWCR[N]<19:16>));
elsif DBGWCR[N]<19:16> != '0000' then UNPREDICTABLE;

return match;
```

C3.3 Halting debug events

A Halting debug event is one of the following:

- An External Debug Request debug event. This is a request from the system for the processor to enter Debug state.

The method of generating an External Debug Request is IMPLEMENTATION DEFINED. Typically it is by asserting an External Debug Request input to the processor.

- A Halt Request debug event. This occurs when the debug logic receives a Halt request command. In v7 Debug, a debugger generates a Halt request command by writing 1 to the DBGDRCR Halt request bit, see *Debug Run Control Register (DBGDRCR)*, v7 Debug only on page C10-29.
- An OS Unlock Catch debug event. This occurs when both of the following are true:
 - the OS Unlock Catch is enabled in the Event Catch Register
 - the OS Lock transitions from the locked to the unlocked condition.

For details see *Event Catch Register (DBGECR)* on page C10-78 and *OS Lock Access Register (DBGOSLAR)* on page C10-75.

If invasive debug is disabled when one of these events is detected, the request is ignored and no Halting debug event occurs. Invasive debug is disabled when the external debug interface signal **DBGEN** is LOW.

If **DBGEN** is HIGH, meaning that invasive debug is enabled, and a Halting debug event occurs when it is not permitted, the Halting debug event is pended. This means that the processor enters Debug state when it transitions to a security state or processor mode where the Halting debug event is permitted.

However, if **DBGEN** goes LOW before the processor enters the security state or processor mode where the Halting debug event is permitted, it is UNPREDICTABLE whether the event remains pended. If the debug logic is reset before the processor enters the permitted security state or processor mode, the processor must remove pending Halt Request and OS Unlock catch debug events. Whether a pending External Debug Request debug event is removed is IMPLEMENTATION DEFINED.

————— Note —————

The IMPLEMENTATION DEFINED details of External Debug Request might specify that it is pended externally by the peripheral that is driving it until the processor acknowledges the request by entering Debug state. In such a system the pending request is typically held over a debug logic reset.

If a Halting debug event occurs when debug is enabled and the event is permitted, or the Halting debug event becomes permitted while it is pending, it is guaranteed that Debug state is entered by the end of the next *Instruction Synchronization Barrier (ISB)* operation, exception entry, or exception return.

See *Run-control and cross-triggering signals* on page AppxA-5 for details of the recommended external debug interface.

In v6 Debug and v6.1 Debug:

- if the processor implements the recommended ARM Debug Interface v4, the Halt request command is issued through the JTAG interface, by placing the HALT instruction in the IR and taking the *Debug Test Access Port State Machine* (Debug TAP State Machine) through the Run-Test/Idle state
- the OS Unlock Catch debug event is not supported.

In v6 Debug it is IMPLEMENTATION DEFINED whether Halting debug events cause entry to Debug state when Halting debug-mode is not configured and enabled.

C3.4 Generation of debug events

The generation of Breakpoint and Watchpoint debug events can be dependent on the context of the processor, including:

- the current processor mode
- the contents of the CONTEXTIDR
- the Secure security state setting, if the processor implements Security Extensions.

The generation of debug events is also dependent on the state of the debug event generation logic:

- Breakpoint debug events are dependent on the contents of the relevant Breakpoint Register Pair (BRP)
- Watchpoint debug events are dependent on the contents of the relevant Watchpoint Register Pair (WRP)
- Linked Breakpoint or Watchpoint debug events are dependent on the settings of a second BRP
- Vector Catch debug events are dependent on the settings in the Vector Catch Register (DBGVCR)
- OS Unlock Catch debug events are dependent on the setting of the Event Catch Register (DBGECR).

In addition, as shown in Table C3-1 on page C3-2, the generation of debug events is dependent on:

- the invasive debug authentication settings, see Chapter C2 *Invasive Debug Authentication*
- the values of the DBGDSCR.HDBGGen and DBGDSCR.MDBGGen bits, see *Debug Status and Control Register (DBGDSCR)* on page C10-10.

The following events are guaranteed to take effect on the debug event generation logic by the end of the next ISB operation, exception entry, or exception return:

- Context changing operations, including:
 - mode changes
 - writes to the CONTEXTIDR
 - security state changes.
- Operations that change the state of the debug event generation logic, including:
 - writes to BRP registers, for Breakpoint debug events, or Linked Breakpoint or Watchpoint debug events
 - writes to WRP registers, for Watchpoint debug events
 - writes to the DBGVCR, for Vector Catch debug events
 - writes to the DBGECR, for OS Unlock Catch debug events
 - changes to the authentication signals
 - writes to the DBGDSCR.

Usually, exception return sequences are also context changing operations, and hence the context change operation is guaranteed to take effect on the breakpoint matching logic by the end of that exception return sequence.

To ensure a change in the debug event generation logic has completed before a particular event or piece of code is debugged you must include an ISB, exception entry or exception return after the change in the Debug settings. In the absence of an ISB, exception entry or exception return, it is UNPREDICTABLE when the changes take place.

Between a context change operation and the end of the next ISB, exception entry or exception return it is UNPREDICTABLE whether the processing of a debug event depends on the old or the new context.

Between operations that change the state of the debug event generation logic and the end of the next ISB, exception entry or exception return, it is UNPREDICTABLE whether debug event generation depends on the old or the new settings. Example C3-1 describes such a case.

Example C3-1 Unpredictability in debug event generation

A breakpoint is set at an address programmed in its Breakpoint Value Register (DBGBVR) and is configured through its Breakpoint Control Register (DBGBCR). In this example:

- DBGBCR is programmed to only match in User, Supervisor or System modes
- the address in the DBGBVR is the address of an instruction in an abort handler routine normally entered from the Prefetch Abort exception vector in Abort mode, but located after that handler switches from Abort mode to Supervisor mode using a CPS instruction.

If there is no ISB, exception entry or exception return between the CPS instruction and the instruction at the breakpoint address, it is UNPREDICTABLE whether the breakpoint matches, even though the instruction is executed in Supervisor mode.

Such an ISB, exception entry or exception return is usually not required to ensure correct operation of the program. In this example because the program is switching between two privileged modes it is not required to ensure correct operation of the memory system.

ARMv7 does not require that such changes take effect on instruction fetches from the memory system, or on memory accesses made by the processor, at the same point as they take effect on the debug logic. The only architectural requirement is that such a change executed before an ISB operation must be visible to both the memory system and the debug logic for all instructions executed after the ISB operation. This requirement is described earlier in this section.

The processor must test for any possible:

- Watchpoint debug event before a memory access operation is observed.
- Breakpoint or Vector Catch debug event before the instruction is executed, that is, before the instruction has any effect on the architectural state of the processor.

As a result, for an instruction that modifies the context in which the processor tests for debug events, the processor must test for all possible debug event in terms of the context before the memory access operation is observed or the instruction executes. For example:

- In a v7 Debug implementation that uses the memory-mapped interface, a write to the DBGWCR to enable a watchpoint on a Data Virtual Address (DVA) of the DBGWCR itself must not trigger the watchpoint.

Conversely, a write to the DBGWCR to disable the same watchpoint must trigger the watchpoint. For more information, see *Debug events in the debug monitor* on page C3-26.

- An instruction that writes to a Breakpoint Control Register (DBGBCR) or Vector Catch Register (DBGVCR) to enable a debug event on the Instruction Virtual Address (IVA) of the instruction itself *must not* trigger the debug event.

Conversely, a write to the DBGBCR or DBGVCR to disable the same debug event must trigger the debug event.

C3.5 Debug event prioritization

Debug events can be synchronous or asynchronous:

- Breakpoint, Vector Catch, BKPT Instruction, and synchronous Watchpoint debug events are all synchronous debug events
- asynchronous Watchpoints and all Halting debug events are all asynchronous debug events.

A single instruction can generate a number of synchronous debug events. It can also generate a number of synchronous exceptions. The principles given in *Exception priority order* on page B1-33 apply to those exceptions and debug events, in addition to the following:

- An instruction fetch that generates an MMU fault, MPU fault, or external abort does not generate a Breakpoint or Vector Catch debug event.
- Breakpoint and Vector Catch debug events are associated with the instruction and are taken before the instruction executes. Therefore, when a Breakpoint or Vector Catch debug event occurs no other synchronous exception or debug event that would have occurred as a result of executing the instruction is generated.
- If a single instruction has more than one of the following debug events associated with it, it is UNPREDICTABLE which is taken:
 - Breakpoint
 - Vector Catch.
- No instruction is valid if it has a Prefetch Abort exception associated with it. Therefore, if an instruction causes a Prefetch Abort exception no other synchronous exception or debug event that would have occurred as a result of executing the instruction is generated.
- An instruction that generates an Undefined Instruction exception does not cause any memory access, and therefore cannot cause a Data Abort exception or a Watchpoint debug event.
- A memory access that generates an MMU fault or an MPU fault must not generate a Watchpoint debug event.
- A memory access that generates an MMU fault, an MPU fault, or a synchronous Watchpoint debug event must not generate an external abort.
- All other synchronous exceptions and synchronous debug events are mutually exclusive, and are derived from a decode of the instruction.

The ARM architecture does not define when asynchronous debug events other than asynchronous Watchpoint debug events are taken. Therefore the prioritization of asynchronous debug events other than asynchronous Watchpoint debug events is IMPLEMENTATION DEFINED.

Debug events must be taken in the execution order of the sequential execution model. This means that if an instruction causes a debug event then that event must be taken before any debug event on any instruction that would execute after that instruction, in the sequential execution model. In particular, if the execution of an instruction generates an asynchronous Watchpoint debug event:

- the asynchronous Watchpoint debug event must not be taken if the instruction also generates any synchronous debug event
- if the instruction does not generate any synchronous debug event, then the asynchronous Watchpoint debug event must be taken before any subsequent:
 - synchronous or asynchronous debug event
 - synchronous or asynchronous precise exception

Chapter C4

Debug Exceptions

This chapter describes debug exceptions, that are used to handle debug events when the processor is configured for Monitor debug-mode. It contains the following sections:

- *About debug exceptions* on page C4-2
- *Effects of debug exceptions on CP15 registers and the DBGWFEAR* on page C4-4.

C4.1 About debug exceptions

A debug exception is taken when:

- a permitted Software debug event occurs when invasive debug is enabled and Monitor debug-mode is selected
- a BKPT instruction is executed when one of:
 - invasive debug is disabled
 - the debug event is not permitted
 - no debug-mode is selected.

For more information, see Table C3-1 on page C3-2. You must be careful when programming certain events because you might leave the processor in an unrecoverable state. See *Unpredictable behavior on Software debug events* on page C3-24.

How the processor handles the debug exception depends on the cause of the exception, and is described in:

- *Debug exception on Breakpoint, BKPT Instruction or Vector Catch debug events*
- *Debug exception on Watchpoint debug event* on page C4-3.

Halting debug events never cause a debug exception. The Halting debug events are:

- External Debug Request debug event
- Halt Request debug event
- OS Unlock Catch debug event.

C4.1.1 Debug exception on Breakpoint, BKPT Instruction or Vector Catch debug events

If the cause of the debug exception is a Breakpoint, BKPT Instruction, or a Vector Catch debug event, the processor performs the following actions:

- Sets the DBGDSCR.MOE bits according to Table C10-3 on page C10-26.
- Sets the IFSR and IFAR as described in *Effects of debug exceptions on CP15 registers and the DBGWFAR* on page C4-4.
- Generates a Prefetch Abort exception, see *Prefetch Abort exception* on page B1-54

The Prefetch Abort handler is responsible for checking the IFSR bits to find out whether the exception entry was caused by a debug exception. If it was, typically the handler branches to the debug monitor.

C4.1.2 Debug exception on Watchpoint debug event

If the cause of the debug exception is a Watchpoint debug event, the processor performs the following actions:

- Sets the DBGDSCR.MOE bits either to Asynchronous Watchpoint Occurred or to Synchronous Watchpoint Occurred.
- Sets the DFSR, DFAR, and DBGWFAR as described in *Effects of debug exceptions on CP15 registers and the DBGWFAR* on page C4-4.
- Generates a precise Data Abort exception, see *Data Abort exception* on page B1-55.

For more information, see *Synchronous and Asynchronous Watchpoint debug events* on page C3-18.

The Data Abort handler is responsible for checking the DFSR bits to find out whether the exception entry was caused by a debug exception. If it was, typically the handler branches to the debug monitor:

- The DBGWFAR indicates the address of the instruction that caused the Watchpoint debug event. see *Watchpoint Fault Address Register (DBGWFAR)* on page C10-28.
- LR_abt holds the address of (instruction to restart at + 8). If the watchpoint is synchronous, the instruction to restart at is the instruction that triggered the watchpoint.

C4.2 Effects of debug exceptions on CP15 registers and the DBGWFAR

There are four CP15 registers that are used to record abort information:

- DFAR** Data Fault Address Register, see:
- *c6, Data Fault Address Register (DFAR)* on page B3-124 for a VMSA implementation
 - *c6, Data Fault Address Register (DFAR)* on page B4-57 for a PMSA implementation.
- IFAR** Instruction Fault Address Register, see:
- *c6, Instruction Fault Address Register (IFAR)* on page B3-125 for a VMSA implementation
 - *c6, Instruction Fault Address Register (IFAR)* on page B4-58 for a PMSA implementation.
- DFSR** Data Fault Status Register, see:
- *c5, Data Fault Status Register (DFSR)* on page B3-121 for a VMSA implementation
 - *c5, Data Fault Status Register (DFSR)* on page B4-55 for a PMSA implementation.
- IFSR** Instruction Fault Status Register, see:
- *c5, Instruction Fault Status Register (IFSR)* on page B3-122 for a VMSA implementation
 - *c5, Instruction Fault Status Register (IFSR)* on page B4-56 for a PMSA implementation.

Their usage model for normal operation is described in:

- *Fault Status and Fault Address registers in a VMSA implementation* on page B3-48 for a VMSA implementation
- *Fault Status and Fault Address registers in a PMSA implementation* on page B4-18 for a PMSA implementation.

Additional registers might be used to return additional IMPLEMENTATION DEFINED fault status information, see:

- *c5, Auxiliary Data and Instruction Fault Status Registers (ADFSR and AIFSR)* on page B3-123 for a VMSA implementation
- *c5, Auxiliary Data and Instruction Fault Status Registers (ADFSR and AIFSR)* on page B4-56 for a PMSA implementation.

Also, information can be returned in the *Watchpoint Fault Address Register (DBGWFAR)*. The implementation of the DBGWFAR depends on the Debug architecture version:

- In v6 Debug it is implemented as a register in CP15 c6.
- In v6.1 Debug it is implemented in CP14, and use of the CP15 alias is deprecated.
- In v7 Debug it can be implemented in the Extended CP14 interface, and has no alias in CP15.

For more information, see *Watchpoint Fault Address Register (DBGWFAR)* on page C10-28.

In Monitor debug-mode the behavior on the exception generated as a result of a Breakpoint, BKPT Instruction, or Vector Catch debug events is as follows:

- the IFSR is updated with the encoding for a debug event, IFSR[10,3:0] = 0b00010
- the IFAR is UNKNOWN following these debug exceptions
- the DFSR, DFAR and DBGWFAR are unchanged.

In Monitor debug-mode the behavior on the exception generated as a result of a Watchpoint debug event is as follows:

- the IFSR and IFAR are unchanged.
- the DFSR is updated with the encoding for a debug event, DFSR[10,3:0] = 0b00010.
- the Domain and [Write](#) fields in the DFSR, DFSR[11,7:4], are UNKNOWN. However, an ARMv6 watchpoint sets the Domain field.
- the DFAR is UNKNOWN.
- the DBGWFAR is updated with the Instruction Virtual Address (IVA) of the instruction that accessed the watchpointed address, plus an offset that depends on the instruction set state of the processor for that instruction:
 - 8 in ARM state
 - 4 in Thumb and ThumbEE states
 - IMPLEMENTATION DEFINED in Jazelle state.

See *Memory addresses* on page C3-23 for a definition of the IVA used to update the DBGWFAR. [1](#)

Chapter C5

Debug State

This chapter describes Debug state, that is entered if a debug event occurs when the processor is configured for Halting debug-mode. It contains the following sections:

- *About Debug state* on page C5-2
- *Entering Debug state* on page C5-3
- *Behavior of the PC and CPSR in Debug state* on page C5-7
- *Executing instructions in Debug state* on page C5-9
- *Privilege in Debug state* on page C5-13
- *Behavior of non-invasive debug in Debug state* on page C5-19
- *Exceptions in Debug state* on page C5-20
- *Memory system behavior in Debug state* on page C5-24
- *Leaving Debug state* on page C5-28.

C5.1 About Debug state

When invasive debug is enabled, the processor switches to a special state called Debug state if one of:

- a permitted Software debug event occurs and Halting debug-mode is selected
- a permitted Halting debug event occurs
- a Halting debug event becomes permitted while it is pending.

For more information, see *State* on page B1-3. In Debug state, control passes to an external agent.

————— Note —————

The external agent is usually a debugger. However it might be some other agent connecting to the debug port of the processor. This could be another processor in the same *System on Chip* (SoC) device. In part C of this manual this agent is often referred to as a debugger.

In v6 Debug, when debug is enabled and Halting debug-mode is not selected it is IMPLEMENTATION DEFINED whether a Halting debug event causes entry to Debug state. For more information, see Table C3-1 on page C3-2.

Halting debug-mode is configured by setting DBGDSCR[14] to 1, see *Debug Status and Control Register (DBGDSCR)* on page C10-10.

Parts A and B of this manual describe how an ARMv7 processor behaves when it is not in Debug state, that is, when it is in Non-debug state. In Debug state, the processor behavior changes as follows:

- The PC and CPSR behave as described in *Behavior of the PC and CPSR in Debug state* on page C5-7.
- Instructions are prefetched from the Instruction Transfer Register (DBGITR), see *Executing instructions in Debug state* on page C5-9.
- The processor can execute only instructions from the ARM instruction set.
- The rules about modes and privileges are different to those in Non-debug state, see *Privilege in Debug state* on page C5-13.
- Non-invasive debug features are disabled, see *Behavior of non-invasive debug in Debug state* on page C5-19.
- Exceptions are treated as described in *Exceptions in Debug state* on page C5-20. Other software and Halting debug events and interrupts are ignored.
- If the processor implements a DMA engine, its behavior is IMPLEMENTATION DEFINED.
- If the processor implements a cache or other local memory that it keeps coherent with other memories in the system during normal operation, it must continue to service coherency requests from the other memories.

[Leaving Debug state](#) on page C5-28 ~~describes how to leave Debug state.~~



C5.2 Entering Debug state

When invasive debug is enabled, the processor switches to a special state called Debug state if one of:

- a permitted Software debug event occurs and Halting debug-mode is selected
- a permitted Halting debug event occurs
- a Halting debug event becomes permitted while it is pending.

In v6 Debug, when debug is enabled and Halting debug-mode is not selected it is IMPLEMENTATION DEFINED whether a Halting debug event causes entry to Debug state. For more information, see Table C3-1 on page C3-2.

Note

Entering Debug state does not ensure that the effect of any context altering operation performed before Debug state entry is visible to instructions executed in Debug state.

On entering Debug state the processor follows this sequence:

1. The processor signals to the system that it is entering Debug state. Details of the signalling method, including whether it is implemented, are IMPLEMENTATION DEFINED.
2. Processing is halted, meaning:
 - The instruction pipeline is flushed and no more instructions are prefetched from memory.
 - The values of the following are not changed on entering Debug state:
 - the PC and CPSR
 - all general-purpose and program status registers, including SPSR_abt and LR_abt.
 - The values of the PC and CPSR remain unchanged while the processor is in Debug state.
 - Instructions can be executed in Debug state, see *Executing instructions in Debug state* on page C5-9, but when the instruction is executed in this way the normal effects of incrementing the PC and updating the CPSR are masked.
 - The effect of Debug state entry on CP15 registers and debug registers is described in *Effect of entering Debug state on CP15 registers and the DBGWFR* on page C5-4.
 - The processor signals to the system that it is in Debug state. Details of this signalling method, including whether it is implemented, are IMPLEMENTATION DEFINED.
 - The processor might:
 - ensure that all Non-debug state memory operations complete and signal this to the system
 - set the DBGDSCR.ADAdiscard bit to 1.

However, processor behavior regarding memory accesses outstanding at Debug state entry is IMPLEMENTATION DEFINED, see *Asynchronous aborts and entry to Debug state* on page C5-5. Details of the method used to signal to the system that Non-debug state memory operations are complete, including whether any such method is implemented, are IMPLEMENTATION DEFINED.

3. The processor signals that it has entered Debug state and is ready for an external agent to take control:
 - the DBGDSCR.HALTED bit is set to 1
 - the DBGDSCR.MOE field is set according to Table C10-3 on page C10-26.

For details of the recommended external debug interface, see *Run-control and cross-triggering signals* on page AppxA-5 and *DBGACK and DBGCPUDONE* on page AppxA-7.

C5.2.1 Effect of entering Debug state on CP15 registers and the DBGWFAR

The actions taken on entering Debug state depend on what caused the Debug state entry:

- If Debug state was entered following a Watchpoint debug event, then the DBGWFAR is updated with the Instruction Virtual Address (IVA) of the instruction that accessed the watchpointed address, plus an offset that depends on the instruction set state of the processor when the debug event was generated:
 - 8 in ARM state
 - 4 in Thumb and ThumbEE states
 - IMPLEMENTATION DEFINED in Jazelle state.
- Otherwise, the DBGWFAR is unchanged on entry to Debug state.

———— **Note** ————

- The implementation of the DBGWFAR depends on the Debug architecture version:
 - In v6 Debug it is implemented as a register in CP15 c6.
 - In v6.1 Debug it is implemented in CP14, and use of the CP15 alias is deprecated.
 - In v7 Debug it can be implemented in the Extended CP14 interface, and has no alias in CP15.
- For more information, see *Watchpoint Fault Address Register (DBGWFAR)* on page C10-28.
- In all cases, on Debug state entry the DBGWFAR is set as described in this section. [1](#)

In ARMv7, all CP15 registers are unchanged on entry to Debug state. In ARMv6, all CP15 registers except for the DBGWFAR are unchanged on entry to Debug state. The unchanged registers include the IFSR, DFSR, DFAR, and IFAR.

On a processor that implements the Security Extensions, the SCR.NS bit is not changed on entry to Debug state.

C5.2.2 Asynchronous aborts and entry to Debug state

On entry to Debug state, it is IMPLEMENTATION DEFINED whether a processor ensures that all memory operations complete and that all possible outstanding asynchronous aborts have been recognized before it signals that it has entered Debug state.

Behavior in ARMv7

In ARMv7 the behavior on entry to Debug state is signaled by the value of the DBGDSCR.ADAdiscard bit:

If DBGDSCR.ADAdiscard == 1

The processor has already ensured that all possible outstanding asynchronous aborts have been recognized, and the debugger has no additional action to take.

If the processor logic always automatically sets DBGDSCR.ADAdiscard to 1 on entry to Debug state, then DBGDSCR.ADAdiscard is implemented as a read-only bit.

If DBGDSCR.ADAdiscard == 0

The following sequence must occur:

1. The debugger must execute an IMPLEMENTATION DEFINED sequence to determine whether all possible outstanding asynchronous aborts have been recognized. An asynchronous abort recognized as a result of this sequence is not acted on immediately. Instead, the processor latches the abort event and its type. The asynchronous abort is acted on when the processor leaves Debug state.

2. DBGDSCR.ADAdiscard is set to 1.

There are two ways this requirement can be implemented:

- The processor automatically sets this bit to 1 on detecting the execution of the IMPLEMENTATION DEFINED sequence. In this case, DBGDSCR.ADAdiscard is implemented as a read-only bit.
- The IMPLEMENTATION DEFINED sequence sets DBGDSCR.ADAdiscard to 1, using the processor interface to the debug resources. In this case, DBGDSCR.ADAdiscard is implemented as a read/write bit.

When the processor has completed all Non-debug state memory operations it signals this to the system. It is IMPLEMENTATION DEFINED whether the processor ensures that all Non-debug state memory operations are complete on entry to Debug state. If not, the processor does not signal the system until all Non-debug state memory operations are complete. This might be linked to the debugger executing the IMPLEMENTATION DEFINED sequence to determine whether all possible outstanding asynchronous aborts have been recognized.

Details of the method used to signal to the system that Non-debug state memory operations are complete, including whether any such method is implemented, are IMPLEMENTATION DEFINED.

While the processor is in Debug state and DBGDSCR.ADAdiscard is 1, any memory access that causes an asynchronous abort has the effect of setting DBGDSCR.ADABORT_1, the Sticky Asynchronous Data Abort bit, to 1, but has no other effect on the state of the processor. The cause and type of the abort are not recorded. Because the abort is not pended, if the asynchronous abort is an external asynchronous abort and

the Interrupt Status Register (ISR) is implemented, the ISR.A bit is not updated. For more information, see *c12, Interrupt Status Register (ISR)* on page B3-150. The ISR is implemented only on processors that include the Security Extensions.

Any asynchronous abort that is latched before or during the entry to Debug state sequence is not overwritten by any new asynchronous abort. This means the latched abort is not discarded if the processor detects another asynchronous abort while DBGDSCR.ADAAdiscard is set to 1. The processor acts on the latched abort on exit from Debug state. If the asynchronous abort is an external asynchronous abort and the ISR is implemented, the ISR.A bit reads as 1 indicating that an external abort is pending.

If the debugger has executed any memory access instructions, before exiting Debug state it must issue an IMPLEMENTATION DEFINED sequence of operations to ensure that any asynchronous aborts have been recognized and discarded.

On exit from Debug state, the processor automatically clears DBGDSCR.ADAAdiscard to 0.

If an asynchronous abort is signalled to the processor before entry to Debug state or between entry to Debug state and DBGDSCR.ADAAdiscard transitioning from 0 to 1, then the processor acts on the asynchronous abort on exit from Debug state:

- if the CPSR.A bit is 1, the abort is pended, and is taken when the A bit is cleared to 0
- if the CPSR.A bit is 0, the abort is taken by the processor.

For details of the recommended external debug interface, see *Run-control and cross-triggering signals* on page AppxA-5 and *DBGACK and DBGCPUDONE* on page AppxA-7.

Behavior in ARMv6

The behavior of asynchronous aborts on entry to Debug state differs between v6 Debug and v6.1 Debug:

- v6 Debug** DBGDSCR.ADAAdiscard bit is not defined. A debugger must always perform a Data Synchronization Barrier (DSB) following entry to Debug state.
- If the CPSR.A bit is 0 and an asynchronous abort is signalled, the processor takes a Data Abort exception as described in *Undefined Instruction and Data Abort exceptions in Debug state in v6 Debug* on page C5-23. A subsequent read of the processor state by the debugger returns the updated values of CPSR, LR_abt and SPSR_abt.
- The value of DBGDSCR.ADABORT_1 is UNKNOWN when in Non-debug state.
- v6.1 Debug** A debugger must always perform a DSB following entry to Debug state. This DSB causes DBGDSCR.ADAAdiscard to be set to 1.
- DBGDSCR.ADABORT_1 is set to 1 on any asynchronous abort detected while the processor is in Debug state, regardless of the setting of DBGDSCR.ADAAdiscard.

C5.3 Behavior of the PC and CPSR in Debug state

Processing is halted on entry to Debug state, see *Entering Debug state* on page C5-3. After the processor has entered Debug state, a read of the PC returns a return address plus an offset. The return address depends on the type of debug event, and the offset depends on the instruction set state of the processor when Debug state was entered. Table C5-1 shows the values returned by a read of the PC.

Table C5-1 PC value while in Debug state

Debug event	PC value, for instruction set state on Debug entry			Meaning of return address (RA) ^a obtained from PC read
	ARM	Thumb or ThumbEE	Jazelle ^b	
Breakpoint	RA + 8	RA + 4	RA + Offset	Breakpointed instruction address
Synchronous Watchpoint	RA + 8	RA + 4	RA + Offset	Address of the instruction that triggered the watchpoint ^c
Asynchronous Watchpoint	RA + 8	RA + 4	RA + Offset	Address of the instruction for the execution to resume ^d
BKPT instruction	RA + 8	RA + 4	RA + Offset	BKPT instruction address
Vector Catch	RA + 8	RA + 4	RA + Offset	Vector address
External Debug Request	RA + 8	RA + 4	RA + Offset	Address of the instruction for the execution to resume
Halt Request	RA + 8	RA + 4	RA + Offset	Address of the instruction for the execution to resume
OS Unlock Catch	RA + 8	RA + 4	RA + Offset	Address of the instruction for the execution to resume

- Return address (RA) is the address of the first instruction that the processor must execute on exit from Debug state. This enables program execution to continue from where it stopped.
- Offset* is an IMPLEMENTATION DEFINED value that is constant and documented.
- Returning to RA has the effect of retrying the instruction. This can have implications under the memory order model. See *Synchronous and Asynchronous Watchpoint debug events* on page C3-18.
- RA is not the address of the instruction that triggered the watchpoint, but one that was executed some number of instructions later. The address of the instruction that triggered the watchpoint can be discovered from the value in the DBGWFER. See *Watchpoint Fault Address Register (DBGWFER)* on page C10-28.

On entry to Debug state, the value of the CPSR is the value that the instruction at the return address would have been executed with, if it had not been cancelled by the debug event.

Note

This rule also applies to the CPSR.IT bits. On entry to Debug state these bits apply to the instruction at the return address.

The behavior of the PC and CPSR registers in Debug state is:

- The PC does not increment on instruction execution.
- The CPSR.IT status bits do not change on instruction execution.
- Predictable instructions that explicitly modify the PC or CPSR operate normally, updating the PC or CPSR.
- After the processor has entered Debug state, if 0b1111 (the PC) is specified as a source operand for an instruction it returns a value as described in Table C5-1 on page C5-7. The value read from the PC is aligned according to the rules of the instruction set state indicated by the CPSR.J and CPSR.T execution state bits, regardless of the fact that the processor only executes the ARM instruction set in Debug state. For more information, see *Executing instructions in Debug state* on page C5-9.
- If an instruction sequence for writing a particular value to the PC is executed while in Debug state, and the processor is later forced to restart without any additional write to the PC or CPSR, the execution starts at the address corresponding to the written value.
- If the CPSR is written to while in Debug state, subsequent reads of the PC return an UNKNOWN value, and if the processor is later forced to restart without having performed a write to the PC, the restart address is UNKNOWN. However, the CPSR can be read correctly while in Debug state.

Note

In v6 Debug, the CPSR and PC can be written in a single instruction, for example, `MOVSp, 1r`. In this case, the behavior is as if the CPSR is written first, followed by the PC. That is, if the processor is later forced to restart the restart address is predictable. This does not apply to v6.1 Debug or v7 Debug because in these versions of the Debug architecture such instructions are themselves UNPREDICTABLE in Debug state.

- If the processor is forced to restart without having performed a write to the PC, the restart address is UNKNOWN.
- If the PC is written to while in Debug state, later reads of the PC return an UNKNOWN value.

See also *Executing instructions in Debug state* on page C5-9, for more restrictions on instructions that might be executed in Debug state, including those that access the PC and CPSR.

C5.4 Executing instructions in Debug state

In Debug state the processor executes instructions issued through the Instruction Transfer Register, see *Instruction Transfer Register (DBGITR)* on page C10-46. This mechanism is enabled through DBGDSCR[13], see *Debug Status and Control Register (DBGDSCR)* on page C10-10.

The following rules and restrictions apply to instructions that can be executed in this manner in Debug state:

- The processor instruction set state always corresponds to the state indicated by the CPSR.J and CPSR.T execution state bits. However, the processor always interprets the instructions issued through the DBGITR as ARM instruction set opcodes, regardless of the setting of the CPSR.J and CPSR.T execution state bits.

Some ARM instructions are UNPREDICTABLE if executed in Debug state. These instructions are either:

- identified as UNPREDICTABLE in this list
- shown as UNPREDICTABLE in Table C5-2 on page C5-10.

Otherwise, except for the value read from the PC, instructions executed in Debug state operate as specified for ARM state. *Behavior of the PC and CPSR in Debug state* on page C5-7 specifies the value read from the PC.

- The CPSR.IT execution state bits are ignored. This means that instructions issued through the DBGITR do not fail their condition tests unexpectedly. However, the condition code field in an ARM instruction is honored.
The CPSR.IT execution state bits are preserved and do not change when instructions are executed, unless an instruction that modifies those bits explicitly is executed.
- The branch instructions B, BL, BLX (immediate), and BLX (register) are UNPREDICTABLE in Debug state.
- The hint instructions WFI, WFE and YIELD are UNPREDICTABLE in Debug state.
- All memory read and memory write instructions with the PC as the base address register read an UNKNOWN value for the base address.
- Certain instructions that normally update the CPSR can be UNPREDICTABLE in Debug state, see *Writing to the CPSR in Debug state* on page C5-10.
- Instructions that load a value from memory into the PC are UNPREDICTABLE in Debug state.
- Conditional instructions that write explicitly to the PC are UNPREDICTABLE in Debug state.
- There are additional restrictions on data-processing instructions that write to the PC. See *Data-processing instructions with the PC as the target in Debug state* on page C5-12.
- The exception-generating instructions SVC, SMC and BKPT are UNPREDICTABLE in Debug state.

- A coprocessor can impose additional constraints or usage guidelines for executing coprocessor instructions in Debug state. For example a coprocessor that signals internal exception conditions asynchronously using the Undefined Instruction exception, as described in *Undefined Instruction exception* on page B1-49, might require particular sequences of instructions to avoid the corruption of coprocessor state associated with the exception condition.

~~In the case of the VFP coprocessors, these sequences are defined by the VFP subarchitecture. Other coprocessors must define any sequences that they require.~~

———— **Note** —————

The definition of UNPREDICTABLE implies that an UNPREDICTABLE instruction executed in Debug state must not put the processor into a state or mode in which debug is not permitted, or change the state of any register that cannot be accessed from the current state and mode.

C5.4.1 Writing to the CPSR in Debug state

Table C5-2 lists all the instructions that normally update the CPSR, and shows their behavior in Debug state. Which instructions are permitted in Debug state depends on the version of the Debug architecture.

Table C5-2 Instructions that modify the CPSR, and their behavior in Debug state

Instruction	v6 Debug	v6.1 Debug, v7 Debug
BX	UNPREDICTABLE if CPSR.J is 1. Can be used to set or clear the CPSR.T bit.	UNPREDICTABLE.
BXJ	UNPREDICTABLE if either CPSR.J or CPSR.T is 1. Can be used to set CPSR.J to 1.	UNPREDICTABLE.
SETEND	UNPREDICTABLE.	UNPREDICTABLE.
CPS	UNPREDICTABLE.	UNPREDICTABLE.
<op>S PC, <Rn>, <Rm> ^a	Can be used to set the CPSR to any value by copying it from the SPSR of the current mode.	UNPREDICTABLE.
<op> PC, <Rn>, <Rm> ^a	Do not update the CPSR.	See <i>Data-processing instructions with the PC as the target in Debug state</i> on page C5-12.
MSR CPSR_fsrc	Use for setting the CPSR bits other than the execution state bits.	Use for setting the CPSR to any value.
MSR CPSR_<not fsrc>	Use for setting the CPSR bits other than the execution state bits.	UNPREDICTABLE.
LDM (exception return), RFE	UNPREDICTABLE.	UNPREDICTABLE.

a. <op> is one of ADC, ADD, AND, ASR, BIC, EOR, LSL, LSR, MOV, MVN, ORR, ROR, RRX, RSB, RSC, SBC, or SUB.

Note

Table C5-2 on page C5-10 does not:

- Include instructions that only update the CPSR bits that are available in the APSR, that is the N, Z, C, V, Q, and GE[3:0] bits. These instructions have their normal behavior when executed in Debug state.
 - Include instructions that cause exceptions, such as SVC, SMC, and memory access instructions that cause aborts. The behavior of these instructions is described in *Exceptions in Debug state* on page C5-20.
 - Show what values can be written to the CPSR. For more information, see *Altering CPSR privileged bits in Debug state* on page C5-14.
-

MRS and MSR instructions in Debug state, in v6.1 Debug and v7 Debug

In v6.1 Debug and v7 Debug, if the debugger has to update bits in the CPSR that are not available in the APSR then it must use the MSR instruction to do so, writing to CPSR_fsrc. The behavior of the CPSR forms of the MSR and MRS instructions in Debug state differs from their behavior in Non-debug state. In the CPSR:

- in Non-debug state:
 - the execution state bits, other than the E bit, are RAZ when read by an MRS instruction
 - writes to the execution state bits, other than the E bit, by an MSR instruction are ignored
- in Debug state:
 - the execution state bits return their correct values when read by an MRS instruction
 - writes to the execution state bits by an MSR instruction update the execution state bits.

MRS and MSR instructions that read and write an SPSR behave as they do in Non-debug state.

In addition, in Debug state in v6.1 Debug and v7 Debug:

- if you use an MSR instruction to directly modify the execution state bits of the CPSR, you must then perform an Instruction Synchronization Barrier (ISB) operation
- an MSR instruction that does not write to all fields of the CPSR is UNPREDICTABLE
- if an MRS instruction reads the CPSR after an MSR writes the execution state bits, and before an ISB, the value returned is UNKNOWN
- if the processor leaves Debug state after an MSR writes the execution state bits, and before an ISB, the behavior of the processor is UNPREDICTABLE.

C5.4.2 Data-processing instructions with the PC as the target in Debug state

The ARM encodings of the instructions ADC, ADD, AND, ASR, BIC, EOR, LSL, LSR, MOV, MVN, ORR, ROR, RRX, RSB, RSC, SBC, and SUB write to the PC if their Rd field is 0b1111.

When in Non-debug state, these ARM instruction encodings can be executed only in the ARM instruction set state, and their behavior is described in:

- *SUBS PC, LR and related instructions* on page B6-25, if the S bit of the instruction is 1.
- Chapter A8 *Instruction Details*, if the S bit of the instruction is 0. These ARM instructions cause interworking branches in ARMv7, and simple branches in earlier versions of the architecture. The `ALUWritePC()` pseudocode function describes this operation, see *Pseudocode details of operations on ARM core registers* on page A2-12.

In Debug state, these ARM instruction encodings can be executed in any instruction set state, and the following additional restrictions apply:

- If the S bit of the instruction is 1:
 - in v7 Debug and v6.1 Debug, behavior is UNPREDICTABLE
 - in v6 Debug, behavior is as in Non-debug state.
- If the S bit of the instruction is 0, the behavior is always either a simple branch without changing instruction set state or UNPREDICTABLE. Table C5-3 shows how this behavior depends on the instruction set state, the value `alu<1:0>` written to the PC, and the architecture version.

Table C5-3 Debug state rules for data-processing instructions that write to the PC

CPSR.J	CPSR.T	Instruction set state	Architecture version	alu<1:0>	Operation ^a
0	0	ARM	ARMv7	00	BranchTo(alu<31:2>:'00')
				x1	UNPREDICTABLE ^b
				10	UNPREDICTABLE
X	1	Thumb or ThumbEE	ARMv7	xx	BranchTo(alu<31:2>:'00')
				x0	UNPREDICTABLE ^b
				x1	BranchTo(alu<31:1>:'0')
1	0	Jazelle	ARMv7 or ARMv6	xx	BranchTo(alu<31:1>:'0')
				xx	BranchTo(alu<31:0>)

a. Pseudocode description of behavior, when the behavior is not UNPREDICTABLE.

b. This behavior is changed from the behavior in Non-debug state. In all other rows, the behavior described is unchanged from the behavior in Non-debug state.

C5.5 Privilege in Debug state

In Debug state, instructions issued to the processor have the privileges to access and modify processor registers, memory and coprocessor registers that they would have if issued in the same mode and security state in Non-debug state.

In User mode and Debug state, instructions have additional privileges to access or modify some registers and fields that cannot be accessed in User mode in Non-debug state. However, on processors that implement the Security Extensions and support Secure User halting debug, these additional privileges are restricted when all the following conditions are true:

- the processor is in Debug state
- the processor is in Secure User mode
- invasive debug is not permitted in Secure privileged modes, because either **DBGEN** or **SPIDEN** is **LOW**, see Chapter C2 *Invasive Debug Authentication*.

The following sections describe the instruction privileges, and the restrictions on them when these conditions are all true:

- *Accessing registers and memory in Debug state*
- *Altering CPSR privileged bits in Debug state* on page C5-14
- *Changing the SCR.NS bit in Debug state* on page C5-15
- *Coprocessor and Advanced SIMD instructions in Debug state* on page C5-16.

C5.5.1 Accessing registers and memory in Debug state

The rules for accessing ARM core registers and memory are the same in Debug state as in Non-debug state. For example, if the CPSR mode bits indicate the processor is in Supervisor mode:

- reads of ARM core registers return the Supervisor mode registers
- normal load and store operations make privileged accesses to memory
- a load or store with User mode privilege operation, for example LDRT, makes a User mode privilege access [↓](#)

C5.5.2 Altering CPSR privileged bits in Debug state

On processors that implement the Security Extensions, the processor:

- prevents attempts to set the CPSR.M field to a value that would place the processor in a mode or security state where debug is not permitted
- prevents updates to the Privileged bits of the CPSR in cases where Secure User halting debug is supported, the processor is in Secure User mode, and invasive debug is not permitted in Secure privileged modes
- prevents attempts to set the CPSR.M field to 0b10001, FIQ mode, if NSACR.RFR == 1 and the processor is in Non-secure state.

On processors that do not implement the Security Extensions, all CPSR updates that are permitted in a privileged mode when in Non-debug state, are permitted in Debug state.

Table C5-4 defines the behavior on writes to the CPSR in Debug state.

Table C5-4 Permitted updates to the CPSR in Debug state

Mode	Secure state	Logical (DBGEN AND SPIDEN)	SU halting debug ^a supported	Update privileged CPSR bits ^b	Modify CPSR.M to Monitor mode
User	Yes	0	Yes	Update ignored	UNPREDICTABLE ^c
			No	Permitted ^d	Permitted ^d
Privileged	Yes	0	X	Permitted ^d	Permitted ^d
Any	No	0	X	Permitted ^d	UNPREDICTABLE ^c
Any	X	1	X	Permitted ^d	Permitted

a. Secure User halting debug support.

b. This column does not apply to changing CPSR.M to Monitor mode. Apart from this, the CPSR bits are defined in *Program Status Registers (PSRs)* on page B1-14, and this column does apply to changing CPSR.M to any other value.

c. The definition of UNPREDICTABLE implies the processor must not enter a privileged mode.

d. Except that, regardless of the state of **SPIDEN**:

The SCR.AW, SCR.FW and SCTLR.NMFI bits have the same effects on writes to CPSR.A and CPSR.F as they do in Non-debug state, see *Control of exception handling by the Security Extensions* on page B1-41 and *Non-maskable fast interrupts* on page B1-18.

The NSACR.RFR bit has the same effect on writes to CPSR.M as it does in Non-debug state, see *c1, Non-Secure Access Control Register (NSACR)* on page B3-110.

e. The definition of UNPREDICTABLE implies the processor must not enter Monitor mode, and must not enter FIQ mode when NSACR.RFR == 1.

Being in Debug state when invasive halting debug is not permitted

A processor can be in a Secure privileged mode with **SPIDEN** LOW, see *Generation of debug events* on page C3-40 and *Changing the authentication signals* on page AppxA-4. More generally, it is possible to be in Debug state when the current mode, security state or debug authentication signals indicate that, in Non-debug state, debug events would be ignored. There are two situations where this can occur:

- Between a change in the debug authentication signals and the end of the next Instruction Synchronization Barrier operation, exception entry, or exception return. At this point it is ~~it is~~ UNPREDICTABLE whether the behavior of debug events that are generated follows the old or the new authentication signal settings.
- Because it is possible to change the authentication signals while in Debug state.

For example, the following sequence of events can occur:

1. The processor is in a Secure privileged mode. **SPIDEN** and **DBGEN** are both HIGH.
2. An instruction is prefetched that matches all the conditions for a breakpoint to occur.
3. That instruction is committed for execution.
4. At the same time, an external device writes to the peripheral that controls **SPIDEN** and **DBGEN**, causing **SPIDEN** to be deasserted to LOW.
5. **SPIDEN** changes, but the processor is already committed to entering Debug state.
6. The processor enters Debug state and is in a Secure privileged mode, even though **SPIDEN** is LOW.

If this series of events occurs, ~~the processor can change to other Secure privileged modes, including Monitor mode, and update privileged bits in the CPSR, because it is in a privileged mode.~~ However, if the processor leaves Secure state or moves to Secure User mode, it might not be able to return to a Secure privileged mode.

C5.5.3 Changing the SCR.NS bit in Debug state

SCR.NS is the Non-secure state bit, see *c1, Secure Configuration Register (SCR)* on page B3-106. Because this bit is part of a coprocessor register, the rules for executing coprocessor instructions in Debug state apply, see *Coprocessor and Advanced SIMD instructions in Debug state* on page C5-16.

In Debug state, the SCR can be written to:

- when Secure User halting debug is supported:
 - in any Secure privileged mode, including Monitor mode, regardless of the state of **DBGEN** and **SPIDEN**
 - in Secure User mode only if **DBGEN** and **SPIDEN** are both HIGH
- when Secure User halting debug is not supported, in any Secure mode, including Monitor mode, regardless of the state of **DBGEN** and **SPIDEN**.

A write to the SCR in any other case is treated as an Undefined Instruction exception. For details of how Undefined Instruction exceptions are handled in Debug state see *Exceptions in Debug state* on page C5-20.

This is a particular case of the rules for accessing CP15 registers described in *Coprocessor and Advanced SIMD instructions in Debug state*.

———— **Note** —————

Normally, in Monitor mode, any exception automatically clears the SCR.NS bit to 0. However an exception while in Debug state in Monitor mode does not have any effect on the value of the SCR.NS bit.

C5.5.4 Coprocessor and Advanced SIMD instructions in Debug state

The following sections describe the coprocessor and Advanced SIMD instructions in Debug state:

- *Instructions for CP0 to CP13, and Advanced SIMD instructions*
- *Instructions for CP14 and CP15* on page C5-17.

Instructions for CP0 to CP13, and Advanced SIMD instructions

This subsection describes:

- Coprocessor instructions for CP0 to CP13. These include the VFP instructions.
- If the Advanced SIMD extension is implemented, the instruction encodings described in *Advanced SIMD data-processing instructions* on page A7-10 and *Advanced SIMD element or structure load/store instructions* on page A7-27.

Access controls for these instructions are determined:

- by the CPACR, see:
 - *c1, Coprocessor Access Control Register (CPACR)* on page B3-104, for a VMSA implementation
 - *c1, Coprocessor Access Control Register (CPACR)* on page B4-51, for a PMSA implementation.
- additionally, if the Security Extensions are implemented, by the NSACR, see *c1, Non-Secure Access Control Register (NSACR)* on page B3-110.

In v6.1 Debug and v7 Debug, in Debug state the current mode and security state define the privilege and access controls for these instructions.

In v6 Debug, in Debug state it is IMPLEMENTATION DEFINED whether these instructions are executed using the privilege and access controls for the current mode and security state, or using the privilege and access controls for a privileged mode in the current security state.

Instructions for CP14 and CP15

This subsection describes the coprocessor instructions for the internal coprocessors CP14 and CP15.

The two groups of registers provided by CP14 are:

- The CP14 debug registers, accessed by MCR and MRC instructions with `<opc1> == 0b000`. Some of these registers can also be accessed by CP14 LDC and STC instructions.
- The CP14 non-debug registers, accessed by MCR and MRC instructions with `<opc1> != 0b000`. These include the trace registers.

Accesses to CP14 and CP15 are as follows:

- Instructions that access CP14 or CP15 registers that are permitted (not UNDEFINED) in User mode when in Non-debug state, are always permitted in Debug state.
- Instructions that access CP14 debug registers that are permitted (not UNDEFINED) in privileged modes when in Non-debug state are permitted in Debug state, regardless of the debug authentication and the processor mode and security state.
- If Secure User halting debug is supported, ARM recommends that certain CP15 instructions that a debugger requires to maintain memory coherency are permitted in Debug state regardless of debug permissions and the processor mode, see *Access to specific cache management functions in Debug state* on page C5-25.
- If the processor is in a privileged mode or the debugger can write to the CPSR.M bits to change to a privileged mode, then instructions that access CP14 or CP15 registers that are permitted (not UNDEFINED) in privileged modes when in Non-debug state are permitted in Debug state. If the processor is in User mode there is no requirement to change to a privileged mode first.

————— Note —————

- Two particular cases are where Security Extensions are not implemented and where Secure User halting debug is not supported. In these cases the CPSR.M bits can always be changed to a privileged mode and, therefore, the debugger is able to access all CP14 and CP15 registers at all times.
- Except for accesses to the Baseline CP14 debug registers, ARM deprecates accessing any CP14 or CP15 register from User mode in Debug state if that register cannot be accessed from User mode in Non-debug state.

-
- In every case, permissions to access CP14 and CP15 registers while in Debug state are never greater than the permissions granted to any privileged mode when in Non-debug state in the current security state.
 - If the processor is in Secure User mode and the debugger cannot write to the CPSR.M bits to change to a privileged mode, then any instruction that accesses a CP14 non-debug register or a CP15 register is not permitted (UNDEFINED) in Debug state if it is not permitted in Secure User mode in Non-debug state.

- Any CP14 or CP15 register access that is not permitted generates an Undefined Instruction exception. For details of how Undefined Instruction exceptions are handled in Debug state see *Exceptions in Debug state* on page C5-20.
- If the processor is in a privileged mode or the debugger can write to the CPSR.M bits to change to a privileged mode, then any CP14 or CP15 instruction is UNPREDICTABLE in Debug state if that instruction is UNPREDICTABLE in Non-debug state.
- On processors that implement the Security Extensions, any access to a Banked CP15 register accesses the copy for the current security state. If the processor is in Monitor mode, the Non-debug state rules for accessing CP15 registers in Monitor mode apply.

This means that, for example:

- If the processor is stopped in Non-secure state and invasive debug is not permitted in Secure privileged modes then the debugger has access only to those CP15 registers accessible in Non-secure state in Non-debug mode.
- If the processor is stopped with invasive debug permitted in Secure privileged modes then the debugger has access to all CP15 registers. If the processor is in Non-secure state, the debugger can switch the processor to Monitor mode to access the SCR.NS bit, to give access to all CP15 registers.

Invasive debug is permitted in Secure privileged modes when both **SPIDEN** and **DBGEN** are HIGH.

In Debug state, the **CP15SDISABLE** input to the processor operates in exactly the same way as in Non-debug state, see *The CP15SDISABLE input* on page B3-76:

- if **CP15SDISABLE** is HIGH, any operation affected by **CP15SDISABLE** in Non-debug state results in an Undefined Instruction exception in Debug state
- if **CP15SDISABLE** is LOW, it has no effect on any register access.

C5.6 Behavior of non-invasive debug in Debug state

If any non-invasive debug features exist, their behavior in Debug state is broadly the same as when non-invasive debug is not permitted. For details see *About non-invasive debug authentication* on page C7-2.

———— **Note** —————

When the DBGDSCR.DBGack bit, Force Debug Acknowledge, is set to 1 and the processor is in Non-debug state, the behavior of non-invasive debug features is IMPLEMENTATION DEFINED. However, in this case non-invasive debug features must behave either as if in Debug state or as if Non-debug state.

C5.7 Exceptions in Debug state

This section describes how exceptions are handled when the processor is in Debug state:

- exception handling is the same in Debug state in v7 Debug and v6.1 Debug, except for some slight differences in when asynchronous aborts are recognized
- there are some differences in exception handling in Debug state in v6 Debug, and these are indicated.

Exceptions are handled as follows when the processor is in Debug state:

Reset On a Reset exception, the processor leaves Debug state. The reset handler runs in Non-debug state, see *Reset* on page B1-48.

———— **Note** —————

This only applies to a reset that in Non-debug state would cause a Reset exception. It does not apply to a debug logic reset. For more information on debug logic reset, see *Recommended reset scheme for v7 Debug* on page C6-16.

Prefetch Abort

A Prefetch Abort exception cannot be generated because no instructions are prefetched in Debug state.

SVC The SVC instruction is UNPREDICTABLE.

SMC The SMC instruction is UNPREDICTABLE.

BKPT The BKPT instruction is UNPREDICTABLE.

Debug events Debug events are ignored in Debug state.

Interrupts IRQ and FIQ exceptions are disabled and not taken in Debug state.

———— **Note** —————

This behavior does not depend on the values of the I and F bits in the CPSR, and the value of these bits are not changed on entering Debug state.

However, if the *Interrupt Status Register (ISR)* is implemented, the ISR.I and ISR.F bits continue to reflect the values of the IRQ and FIQ inputs to the processor. For more information, see *c12, Interrupt Status Register (ISR)* on page B3-150.

Undefined Instruction

Undefined Instruction exceptions are generated for the same reasons in Debug state as in Non-debug state.

The behavior depends on the Debug architecture version:

v6.1 Debug, v7 Debug

When an Undefined Instruction exception is generated in Debug state, the processor takes the exception as follows:

- PC, CPSR, SPSR_und, LR_und, SCR.NS, and DBGDSCR.MOE are unchanged.
- The processor remains in Debug state.
- DBGDSCR.UND_1, the Sticky Undefined Instruction bit, is set to 1.

For more information, see the description of the UND_1 bit in *Debug Status and Control Register (DBGDSCR)* on page C10-10.

v6 Debug See *Undefined Instruction and Data Abort exceptions in Debug state in v6 Debug* on page C5-23.

Synchronous data abort

Data Abort exceptions are generated by synchronous data aborts in Debug state. The behavior depends on the Debug architecture version:

v6.1 Debug, v7 Debug

When a Data Abort exception is generated by a synchronous data abort in Debug state, the processor takes the exception as follows:

- PC, CPSR, SPSR_abt, LR_abt, SCR.NS, and DBGDSCR.MOE are unchanged.
- The processor remains in Debug state.
- DBGDSCR.SDABORT_1, the Sticky Synchronous Data Abort bit, is set to 1.
- The DFSR and DFAR are updated if any of:
 - Secure User halting debug is not supported
 - the processor is not in Secure User mode
 - invasive debug is permitted in Secure privileged modes.
 Otherwise it is IMPLEMENTATION DEFINED whether the DFSR and DFAR are updated.
- If the ISR is implemented, the ISR.A bit is not changed, because no abort is pending.

See also the description of the SDABORT_1 bit in *Debug Status and Control Register (DBGDSCR)* on page C10-10.

v6 Debug See *Undefined Instruction and Data Abort exceptions in Debug state in v6 Debug* on page C5-23.

Asynchronous abort

The behavior depends on the Debug architecture version:

v6.1 Debug, v7 Debug

When an asynchronous abort is signalled in Debug state, no Data Abort exception is generated and the processor behaves as follows:

- The setting of the CPSR.A bit is ignored.
- PC, CPSR, SPSR_abt, LR_abt, SCR.NS, and DBGDSCR.MOE are unchanged.
- The processor remains in Debug state.
- The DFSR is unchanged.
- If DBGDSCR.ADAdiscard is 1:
 - DBGDSCR.ADABORT_1, the Sticky Asynchronous Data Abort bit, is set to 1.
 - On exit from Debug state, this asynchronous abort is not acted on.
 - If the ISR is implemented, the ISR.A bit is not changed, because no abort is pending.
- If DBGDSCR.ADAdiscard is 0:
 - In v7 Debug, DBGDSCR.ADABORT_1 is unchanged.
 - In v6.1 Debug, DBGDSCR.ADABORT_1 is set to 1.
 - On exit from Debug state, this asynchronous abort is acted on.
 - If the asynchronous abort is an external asynchronous abort, and the ISR is implemented, the ISR.A bit is set to 1 indicating that an external abort is pending.

See also:

- *Asynchronous aborts and entry to Debug state* on page C5-5.
- the descriptions of the ADABORT_1 and ADAdiscard bits in *Debug Status and Control Register (DBGDSCR)* on page C10-10.

v6 Debug When an asynchronous abort is signalled in Debug state, then:

- if the CPSR.A bit is **0**, the abort is generated when the CPSR.A bit is cleared to 0
- if the CPSR.A bit is **1**, a Data Abort exception is generated, see *Undefined Instruction and Data Abort exceptions in Debug state in v6 Debug* on page C5-23.

C5.7.1 Undefined Instruction and Data Abort exceptions in Debug state in v6 Debug

In v6 Debug, if an Undefined Instruction exception is generated when the processor is in Jazelle state and Debug state, the result is UNPREDICTABLE.

Otherwise, in v6 Debug, Undefined Instruction and Data Abort exceptions generated in Debug state are taken by the processor as follows:

- The PC, CPSR, and SPSR_<exception_mode> are set in the same way as in a normal Non-debug state exception entry. In addition:
 - if the exception is an asynchronous abort, and the PC has not yet been written, LR_abt is set as for exception entry in Non-debug state
 - in all other cases, LR_<exception_mode> is set to an UNKNOWN value.
- The processor remains in Debug state, and does not prefetch the exception vector.

In addition, for a Data Abort exception:

- The DFSR and DFAR are set in the same way as in a normal Non-debug state exception entry. The DBGWFAR is set to an UNKNOWN value. The IFSR is not modified.
- DBGDSCR.ADABORT_1 or DBGDSCR.SDABORT_1 is set to 1.
- The DBGDSCR.MOE bits are set to 0b0110, D-side abort occurred.

For more information about asynchronous aborts in ARMv6 see *Behavior in ARMv6* on page C5-6.

Debuggers must take care when processing a debug event that occurred when the processor was executing an exception handler. The debugger must save the values of SPSR_und and LR_und before performing any operation that might result in an Undefined Instruction exception being generated in Debug state. The debugger must also save the values of SPSR_abt and LR_abt, and of the DFSR, DFAR and DBGWFAR before performing an operation that might generate a Data Abort exception when in Debug state. If this is not done, register values might be overwritten, resulting in UNPREDICTABLE software behavior.

C5.8 Memory system behavior in Debug state

The Debug architecture places requirements on the memory system. There are two general guidelines:

- Memory coherency has to be maintained during debugging.
- It is best if debugging is non-intrusive. This requires a way to preserve, for example, the contents of memory caches and translation lookaside buffers (TLBs), so the state of the target application is not altered.

In Debug state, it is strongly recommended that the caches and TLBs, where implemented, behave as described here. For preservation purposes it is strongly recommended that it is possible to:

- disable cache evictions and linefills, so that cache accesses, on read or write, do not cause the contents of caches to change.
- disable TLB evictions and replacements, so that translations do not cause the contents of TLBs to change.

The mechanisms for disabling these operations:

- must be accessible by the external debugger
- are only required when in Debug state.

In v6.1 Debug and v7 Debug, the Debug State Cache Control Register (DBGDSCCR) and the Debug State MMU Control Register (DBGDSMCR) are used for this purpose.

While the processor is in Debug state, no instruction fetches occur and therefore:

- if the system implements separate instruction and data caches then there might be no instruction cache evictions or replacements
- if the system implements separate instruction and data TLBs then there might be no instruction TLB evictions or replacements.

In Debug state, reads must behave as in Non-debug state:

- cache reads return data from the cache
- cache misses fetch from external memory.

A debugger must be able to maintain coherency between instruction and data memory, and maintain coherency in a multiprocessor system. This means that in Debug state a debugger must be able to force all writes to update all levels of memory to the point of coherency.

It must be possible to reset the memory system of the processor to a known safe and coherent state. Also, it must be possible to reset any caches of meta-information, such as branch predictor arrays, to a safe and coherent state.

For debugging purposes ARM recommends that TLBs can be disabled so that all TLB accesses are read from the main translation tables, and not from the TLB. This enables a debugger to access memory without using any virtual to physical memory mapping that is implemented for the application.

C5.8.1 Access to specific cache management functions in Debug state

If a processor includes the Security Extensions and supports Secure User halting debug, it must implement mechanisms that enable memory system requirements to be met when debugging in Secure User mode when invasive debug is not permitted in Secure privileged modes. This is a situation where executing the CP15 cache and TLB control operations would otherwise be prohibited.

To meet these requirements, ARM recommends that, on a processor that implements the Security Extensions and supports Secure User halting debug, when the processor is in Debug state:

- the rules for accessing CP15 registers do not apply for a certain set of register access operations
- the set of operations depends on the Debug architecture version, as shown in Table C5-5.

Table C5-5 CP15 operations permitted from User mode in Debug state

Versions	Operation	Description
v7 Debug	MCR p15,0,<Rt>,c7,c5,0	Invalidate entire instruction cache and flush branch predictor arrays ^a
	MCR p15,0,<Rt>,c7,c5,1	Invalidate instruction cache by MVA ^a
	MCR p15,0,<Rt>,c7,c5,7	Invalidate MVA from branch predictor array
	MCR p15,0,<Rt>,c7,c10,1	Clean data or unified cache line by MVA to point of coherency ^b
	MCR p15,0,<Rt>,c7,c10,2	Clean data or unified cache line by set/way ^b
	MCR p15,0,<Rt>,c7,c11,1	Clean data or unified cache line by MVA to point of unification ^b
	MCR p15,0,<Rt>,c7,c1,0	Invalidate entire instruction cache Inner Shareable ^c
	MCR p15,0,<Rt>,c7,c1,6	Invalidate entire branch predictor array Inner Shareable ^c
v6.1 Debug	MCR p15,0,<Rt>,<Rn>,c5	Invalidate instruction cache by VA range
v6.1 Debug, v7 Debug	MCR p15,0,<Rt>,c7,c5,6	Flush entire branch predictor array

- See also *v7 Debug restrictions on instruction cache invalidation in Secure User debug* on page C5-26.
- A debugger does not have to perform cache cleaning operations if DBGDSCCR.nWT is implemented and is set to 0, see *Debug State Cache Control Register (DBGDSCCR)* on page C10-81. This is because when nWT is set to 0, writes do not leave dirty data in the cache that is not coherent with outer levels of memory. However, the I-cache is not updated, so I-cache invalidate operations are required.
- These instructions are part of the Multiprocessing Extensions. See *Multiprocessor effects on cache maintenance operations* on page B2-23.

These instructions must be executable in Debug state regardless of any processor setting. However, use of an operation can generate an abort if instruction cache lockdown is in use.

For more information about debug access to coprocessor instructions, see *Coprocessor and Advanced SIMD instructions in Debug state* on page C5-16.

For more information about the ARMv7 cache maintenance operations, see:

- *CP15 c7, Cache and branch predictor maintenance functions* on page B3-126 for a VMSA implementation
- *CP15 c7, Cache and branch predictor maintenance functions* on page B4-68 for a PMSA implementation.

In v6 Debug and on any processor that does not implement Security Extensions, or when debugging in a state and mode where privileged CP15 operations can be executed, the debugger can use any CP15 operations. These include, but are not limited to, those operations listed in Table C5-5 on page C5-25.

v7 Debug restrictions on instruction cache invalidation in Secure User debug

An ARMv7 implementation that includes the Security Extensions and supports Secure User halting debug must support Secure User debug access to at least one of these instruction cache invalidation operations:

- Invalidate entire instruction cache, and flush branch predictor arrays, MCR p15,0,<Rt>,c7,c5,0
- Invalidate instruction cache by MVA, MCR p15,0,<Rt>,c7,c5,1.

An implementation might support both of these operations.

If the DSCCR.nWT bit is not implemented, the implementation must also support Secure User debug access to at least the operation to Clean data or unified cache line by MVA to point of coherency.

A debugger requires access to an instruction cache invalidation operations so that it can maintain coherency between instruction memory and data memory, and between processors in a multiprocessor system.

However, the architecture imposes restrictions on the operation of these instructions in Debug state, that are not required when the instructions are used in normal operation. In Secure User mode in Debug state when invasive debug is not permitted in Secure privileged modes:

- If the *Invalidate all instruction caches* operation is supported it must:
 - invalidate all unlocked lines in the cache
 - leave any locked lines in the cache unchanged.

If there are locked lines in the cache the instruction can abort, but only after it has invalidated all unlocked lines. However, there is no requirement for the operation to abort if there are locked lines.

- If the *Invalidate instruction caches by MVA* operation is supported, this operation must not invalidate a locked line. If an instruction attempts to invalidate a locked line in Secure User mode debug the implementation must either:
 - ignore the instruction
 - abort the instruction.

These requirements mean that these instructions might operate differently in Debug state to how they operate in Non-debug state.

———— **Note** —————

In ARMv7, it is IMPLEMENTATION DEFINED whether instruction cache locking is supported.

C5.8.2 Debug state Cache and MMU Control Registers

In v6 Debug, the Debug state MMU Control Register (DBGDSMCR) and Debug state Cache Control Register (DBGDSCCR) are not defined.

In v6.1 Debug, ARM recommends the debug registers DBGDSMCR and DBGDSCCR.

v7 Debug requires DBGDSMCR and DBGDSCCR, but there can be IMPLEMENTATION DEFINED limits on their behavior.

For descriptions of these registers, see *Memory system control registers* on page C10-80.

In all debug implementations there can be IMPLEMENTATION DEFINED support for cache behavior override and, on a VMSA implementation, for TLB debug control.

C5.9 Leaving Debug state

The processor leaves Debug state when a restart request command is received. A restart request can be one of the following:

- An External Restart request. This is a request from the system for the processor to leave Debug state. The External Restart request enables multiple processors to be restarted synchronously. The External Restart request is generated by IMPLEMENTATION DEFINED means. Typically this is by asserting an External Restart request input to the processor.
- A restart request command. In v7 Debug, the restart request command is made by a debugger writing 1 to the DBGDRCR Restart request bit, see *Debug Run Control Register (DBGDRCR)*, v7 Debug only on page C10-29

A number of flags in the *Debug Status and Control Register (DBGDSCR)* must be set correctly before leaving Debug state, see *Debug Status and Control Register (DBGDSCR)* on page C10-10. The flags that must be set are:

- the sticky exception flags, DBGDSCR[8:6], must be set to 0b000
- the Execute ARM Instruction Enable bit, DBGDSCR.ITRen, must be set to 0
- the Latched Instruction Complete flag, DBGDSCR.InstrCompl_1, must be set to 1.

In v7 Debug the sticky exception flags are cleared to 0 by writing 1 to the Clear Sticky Exceptions bit of the DBGDRCR. This operation can be combined with the restart request command. For more information see *Debug Run Control Register (DBGDRCR)*, v7 Debug only on page C10-29.

If the processor is signaled to leave Debug state without all of these flags set to the correct values the results are UNPREDICTABLE.

On receipt of a restart request, the processor performs a sequence of operations to leave Debug state.

If DBGDSCR is read during the restart sequence, DBGDSCR.RESTARTED must read as 0 and DBGDSCR.HALTED must read as 1. At all other times DBGDSCR.RESTARTED must read as 1.

On completion of the restart sequence, the processor leaves Debug state:

- DBGDSCR.HALTED is set to 0.
- The processor stops ignoring debug events and starts executing instructions from the address held in the PC, in the mode and instruction set state indicated by the current value of the CPSR. The execution state bits of the CPSR are honored, and the IT bits state machine is restarted, with the current value applying to the first instruction executed.
- Unless the DBGDSCR.DBGack bit is set to 1, the processor signals to the system that it is in Non-debug state. Details of this signalling method, including whether it is implemented, are IMPLEMENTATION DEFINED.

Note

Leaving Debug state is not a memory barrier operation. This means that:

- If a debugger executes any context altering operations in Debug state, it must issue an Instruction Synchronization Barrier (ISB) instruction before leaving Debug state
 - If the debugger executes any memory access instructions in Debug state, it must execute a Data Synchronization Barrier (DSB) instruction before leaving Debug state, to ensure those accesses are complete. This DSB might form part of the IMPLEMENTATION DEFINED sequence of instructions required to ensure that the processor has recognized any asynchronous aborts, as described in *Asynchronous aborts and entry to Debug state* on page C5-5.
-

For details of the recommended external debug interface, see *Run-control and cross-triggering signals* on page AppxA-5 and *DBGACK and DBGCPUDONE* on page AppxA-7.

In v6 Debug and v6.1 Debug:

- the DBGDRCR and External Restart request are not supported
- if the processor implements the recommended ARM Debug Interface v4, the restart request command is issued through the JTAG interface by placing the RESTART instruction in the IR and taking the Debug TAP State Machine through the Run-Test/Idle state. Connecting multiple JTAG interfaces in series enables multiple processors to be restarted synchronously.

Chapter C6

Debug Register Interfaces

This chapter describes the debug register interfaces. It contains the following sections:

- *About the debug register interfaces* on page C6-2
- *Reset and power-down support* on page C6-4
- *Debug register map* on page C6-18
- *Synchronization of debug register updates* on page C6-24
- *Access permissions* on page C6-26
- *The CP14 debug register interfaces* on page C6-32
- *The memory-mapped and recommended external debug interfaces* on page C6-43.

C6.1 About the debug register interfaces

The Debug architecture defines a set of debug registers. The debug register interfaces provide access to these registers. This chapter describes the different ways of implementing the debug register interfaces.

The debug register interfaces provide access to the debug registers from:

- software running on the processor, see *Processor interface to the debug registers*
- an external debugger, see *External interface to the debug registers*.

The debug register interfaces always include the *Debug Communications Channel*, see *The Debug Communications Channel (DCC)* on page C6-3.

C6.1.1 Processor interface to the debug registers

Table C6-4 on page C6-32 lists the set of CP14 debug instructions for accessing the debug registers that must be implemented.

The possible interfaces between the software running on the processor and the debug registers are:

- The Baseline CP14 interface. This provides access to a small set of the debug registers through a set of coprocessor instructions. It must be implemented by all processors.
- The Extended CP14 interface. This provides access to the remaining debug registers through a coprocessor interface. It is required in v6 Debug and v6.1 Debug, and is optional in v7 Debug.
- The memory-mapped interface. This provides memory-mapped access to the debug registers. It is introduced in v7 Debug, and is an optional interface. When it is implemented:
 - some of the registers that are accessed through the Baseline CP14 interface are not available through the memory-mapped interface
 - it is IMPLEMENTATION DEFINED whether the memory-mapped interface is visible only to the processor in which the debug registers are implemented, or is also visible to other processors in the system.

An ARMv7 implementation must include the Baseline CP14 interface and at least one of:

- the Extended CP14 interface
- the memory-mapped interface.

C6.1.2 External interface to the debug registers

Every ARMv6 and ARMv7 implementation must include an external debug interface. This interface provides access to the debug registers from an external debugger through a *Debug Access Port (DAP)*. This interface is IMPLEMENTATION DEFINED. For details of the interface recommended by ARM:

- for an ARMv7 implementation, see the *ARM Debug Interface v5 Architecture Specification*
- for an ARMv6 implementation, contact ARM.

The Debug architecture does not require implementation of the recommended interface. However:

- the ARM RealView tools require the recommended interface
- ARM recommends this interface for compatibility with other tool chains.

C6.1.3 The Debug Communications Channel (DCC)

The debug register interface includes the *Debug Communications Channel* (DCC). This is accessed through two physical registers:

- DBGDTRTX, for data transfers from the processor to an external debugger
- DBGDTRRX, for data transfers from the external debugger to the processor.

In addition, there are four DCC status flags in the DBGDSCR:

- TXfull and TXfull_l, indicating the DBGDTRTX status
- RXfull and RXfull_l, indicating the DBGDTRRX status.

There are separate internal and external views of the DBGDSCR, and of the DBGDTRTX and DBGDTRRX Registers:

- DBGDTRTXint, DBGDTRRXint and DBGDSCRint provide the internal view
- DBGDTRTXext, DBGDTRRXext and DBGDSCRext provide the external view.

For more information, see *Internal and external views of the DBGDSCR and the DCC registers* on page C6-21.

———— **Note** —————

In previous descriptions of the DCC, the term DTR (*Data Transfer Register*) is used to describe the DCC data registers. In those descriptions, the DBGDTRTX Register is named wDTR, and the DBGDTRRX Register is named rDTR.

C6.2 Reset and power-down support

This section contains the following subsections:

- *Debug guidelines for systems with energy management capability*
- *Power domains and debug* on page C6-5
- *The OS Save and Restore mechanism* on page C6-8
- *Recommended reset scheme for v7 Debug* on page C6-16.

C6.2.1 Debug guidelines for systems with energy management capability

ARMv7 processors can be built with energy management capabilities. This section describes how to use the v7 Debug features to debug software running on these systems.

v7 Debug ~~only permits~~ debugging software that is running on a system where:

- energy-saving measures are taken ~~only~~ when the processor is in an idle state
- it is a function of the operating system, or other supervisor code, to take any implemented energy-saving measures.



The measures that the OS can take to save energy during an idle state can be split in two groups:

Standby The OS takes some measures, including using IMPLEMENTATION DEFINED features, to reduce energy consumption. The processor preserves the processor state, including the debug logic state. Changing from standby to normal operation does not involve a reset of the processor.

Power-down The OS takes some measures to reduce energy consumption. These measures mean the processor cannot preserve the processor state, and therefore the measures taken must include the OS saving any processor state it requires not to be lost. Changing from power-down to normal operation must include:

- a reset of the processor, after the power level has been restored
- reinstallation of the processor state by the OS.

Standby is the least invasive OS energy saving state. It implies only that the processor is unavailable, and does not clear any of the debug settings. For standby, v7 Debug prescribes only the following:

- If the processor is in standby and a Halting debug event is triggered the processor must leave standby to handle the debug event. If the processor executed a WFI or WFE instruction to enter standby then that instruction is retired.
- If the processor is in standby and the external debug or memory-mapped interface is accessed, the processor must automatically:
 - leave standby
 - respond to the debug transaction
 - go back to standby.

This is possible because the external debug and memory-mapped interface can insert wait states, for example by holding **PREADYDBG LOW**, until the processor has left standby.

The protocol for communicating between the debug logic and the power controller, enabling the processor to leave and return to standby automatically, is IMPLEMENTATION DEFINED.

v7 Debug includes features that can aid software debugging in a system that dynamically powers down the processor. These techniques are described in greater detail in the following sections.

C6.2.2 Power domains and debug

This section does not apply to v6 Debug and v6.1 Debug, which support only a single power domain.

This section discusses how, in v7 Debug, some registers can be split between different power domains to implement support for debug over power-down and re-powering of the processor.



In v7 Debug, it is IMPLEMENTATION DEFINED whether a processor supports debug over power-down:

- debug over power-down can be supported only if the processor implements the features summarized in this section
- when a processor implements the features required for debug over power-down, it is IMPLEMENTATION DEFINED whether a system that includes that processor supports debug over power-down
- usually, a system that does not support debug over power-down implements a single power domain.



An ARMv7 processor with a single power domain cannot support debug over power-down.

This means that the number of power domains supported by an ARMv7 processor is IMPLEMENTATION DEFINED. However, ARM recommends that at least two are implemented, to provide support for debug over power-down. The two power domains required for this are:

- a debug power domain
- a core power domain.

The debug power domain contains the external debug interface control logic and a subset of the debug resources. This subset is determined by physical placement constraints and other considerations that are explained later in this chapter. Figure C6-1 on page C6-7 shows an example of such a system.

For example, this arrangement is useful for debugging systems where several processors are connected to the same debug bus and where one or more of the processors can power-down at any time. It has two advantages:

- The debug bus is not made unavailable by the core power domain powering down:
 - if the debugger tries to access the processor with the core power domain powered-down, the external debug interface can return a slave-generated error response instead of locking the system
 - if the debugger tries to access another processor, it can proceed normally.

The debug bus might be, for example, an APBv3 or internal debug bus.

- Some debug registers are unaffected by power-down. This means that a debugger can, for example, identify the processor while the core power domain is powered-down.

To have full debug support for power-down and re-powering of the processor, the following registers and individual bits need to be in the debug power domain:

DBGECR This enables the debugger to set the OS Unlock Catch bit to 1 any time and still break on completion of the power-up sequence. If this register was in the core power domain, the power-down event would clear this catch bit to 0. For more information, see *Event Catch Register (DBGECR)* on page C10-78.

DBGDRCR[0] Halt request bit

This enables the debugger to request a Debug state entry even if the processor is powered down. Also, if the debugger makes this request before powering-down but the request cannot be satisfied, for example because the processor is in Secure state but $(\text{DBGEN AND SPIDEN}) = 0$, the request remains pending through power-down.

———— **Note** —————

The processor has to be powered up to respond to a pending DBGDRCR[0] Halt request or External Debug request.

OS Lock Access Register

This enables the lock that the OS sets before saving the debug registers to remain set through power-down. For details see *OS Lock Access Register (DBGOSLAR)* on page C10-75.

Device Power-down and Reset registers

These registers must be in the debug power domain because some of their functions are used for debugging power-down events. See *Device Power-down and Reset Control Register (DBGPRCR)*, v7 *Debug only* on page C10-31, *Device Power-down and Reset Status Register (DBGPRSR)*, v7 *Debug only* on page C10-34.

Lock Access Register, if implemented

If implemented, this register must be in the debug power domain because it is used to enable certain accesses by external debug interface, and this functionality is required when debugging power-down events.

Identification registers and the DBGDIDR

The identification registers are at addresses 0xD00-0xDFC, and 0xFD0-0xFEC. For details of these registers see *Management registers, ARMv7 only* on page C10-88.

Debugger operation only requires the above registers and bits to be in the debug power domain. However, to rationalize the split between the debug and core power domains in the register map, ARMv7 requires an implementation that supports debug over power-down to have all bits of the following registers in the debug power domain:

DBGDIDR, DBGECR, and DBGDRCR

No error response is returned on read or write accesses when the core power domain is powered down.

OS Save and Restore registers, and Device Power-down and Reset registers

No error response returned on read or write accesses when the core power domain is powered down. However, accesses to the OS Lock Access Register (DBGOSLAR) and OS Save and Restore Register (DBGOSSRR) are UNPREDICTABLE when the core power domain is powered-down.

All of the management registers, except for the IMPLEMENTATION DEFINED integration registers

The management registers are registers 823 - 1023, in the address range 0xD00-0xFFC. Requiring all these registers to be in the debug power domain simplifies the decoding of register addresses for the registers in the debug power domain.

Note

The CP15 c0 registers (0xD00-0xDFC) are included in this category.

For all other registers, including any IMPLEMENTATION DEFINED registers, it is IMPLEMENTATION DEFINED whether the register is implemented in the core or the debug power domain.

Figure C6-1 shows the recommended power domain split.

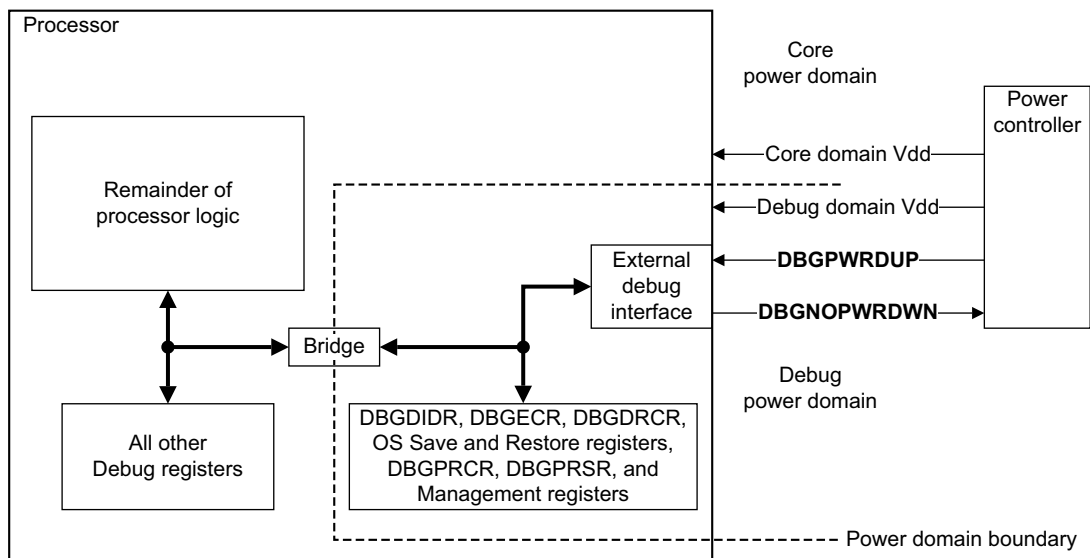

Figure C6-1 Recommended power domain split between core and debug power domains

The signals **DBGNOPWRDWN** and **DBGPWRDUP** shown in Figure C6-1 above form an interface between the power controller and the processor debug logic that is in the debug power domain. With this interface:

- the external debugger can request the power controller to emulate power-down, simplifying the requirements on software by sacrificing entirely realistic behavior

- the external debug interface knows when the core power domain is powered down, and can communicate this information to the external debugger.

For details of these signals see *DBGNOPWRDWN* on page AppxA-9 and *DBGPWRDUP* on page AppxA-10.

If the core power domain is not being powered down at the same time as the debug power domain then the authentication signal **DBGEN** must be pulled LOW before power is removed from the debug power domain. The behavior of the debug logic, and in particular the generation of debug events, is UNPREDICTABLE when the debug power domain is not powered if **DBGEN** is not LOW. Pulling **DBGEN** LOW ensures that debug events are ignored by the processor. For more information, see *Changing the authentication signals* on page AppxA-4.

Reads and writes of debug registers when the debug logic is powered down are UNPREDICTABLE.

The performance monitors must be implemented in the core power domain, and must continue to operate when debug power is removed.

The rest of this part of this manual assumes that two power domains are implemented as described in this section, and that therefore the implementation supports debug over power-down. Features that are not required for an ARMv7 implementation with a single power domain are identified as *SinglePower*, with a description of the differences in behavior. A *SinglePower* implementation cannot support debug over power-down.

C6.2.3 The OS Save and Restore mechanism

The OS Save and Restore mechanism enables an operating system to save the debug registers before power-down and restore them when power is restored. This extends the support for debug over power-down, and permits debug tools to work at a higher level of abstraction when there are no power-down events.

In v7 Debug:

- If an implementation supports debug over power-down, then it must implement the OS Save and Restore mechanism.
- On a *SinglePower* implementation, and on any other implementation that does not support debug over power-down, it is IMPLEMENTATION DEFINED whether the OS Save and Restore mechanism is implemented.
- If the OS Save and Restore mechanism is not implemented, the *DBGOSLSR* must be implemented as *RAZ*, and the other OS Save and Restore mechanism register encodings must be *RAZ/WI*.

In v6 Debug and v6.1 Debug, these registers are not defined.

Two of the requirements for an implementation that supports debug over power-down are:

- An operating system must be able to save and restore the much of the debug logic state over a power-down. This requirement is met by the OS Save and Restore mechanism.
- A debugger must be able to detect that a processor has powered-down. For more information, see *Permissions in relation to power-down* on page C6-28.

The OS Save and Restore mechanism is provided by the following registers:

- OS Save and Restore Register (DBGOSSRR), see *OS Save and Restore Register (DBGOSSRR)* on page C10-77
- OS Lock Access Register (DBGOSLAR), see *OS Lock Access Register (DBGOSLAR)* on page C10-75
- OS Lock Status Register (DBGOSLSR), see *OS Lock Status Register (DBGOSLSR)* on page C10-76
- The Event Catch Register (DBGECR), see *Event Catch Register (DBGECR)* on page C10-78.

You can read the DBGOSLSR to detect whether the OS Save and Restore mechanism is implemented. If it is not implemented the read of the DBGOSLSR returns zero.

The DBGOSSRR works in conjunction with an internal sequence counter, so that a series of reads or writes of this register saves or restores the complete debug logic state of the processor that would be lost when the processor is powered down. The internal sequence counter is reset to the start of the sequence by writing the key, 0xC5ACCE55, to the DBGOSLAR.

The number of accesses required, and the order and interpretation of the data are IMPLEMENTATION DEFINED.

The first access to the DBGOSSRR following the reset of the internal sequence counter must be a read:

- when performing an OS Save sequence this read returns the number of reads from the DBGOSSRR that are needed to save the entire debug logic state
- when performing an OS Restore sequence the value returned by this read is UNKNOWN.

The result of issuing a write to the DBGOSSRR following a reset of the internal sequence counter is UNPREDICTABLE.

———— Note —————

- ~~If the OS Save and Restore mechanism is not implemented, this first read returns zero, correctly indicating to software that no registers are to be saved.~~ 
- An implementation that includes the OS Save and Restore mechanism might not provide access to the DBGOSSRR through the external debug interface. In this case:
 - the DBGOSLSR, DBGOSLAR, and DBGECR are accessible through the external debug interface
 - through the external debug interface, the DBGOSSRR is RAZ/WI
 - because the first read of the DBGOSSRR through the external debug interface returns zero, this indicates that the OS registers cannot be saved or restored through the external debug interface.

The subsequent accesses to the DBGOSSRR must be either all reads or all writes. UNPREDICTABLE behavior results if:

- reads and writes are mixed
- more accesses are performed than the number of registers to be saved or restored, as returned by the first read in the OS Save sequence.
- the subsequent accesses are writes, but the OS Lock is cleared with fewer writes performed than the number of registers to be restored.

The debug logic state of the processor is unchanged if the OS Lock is cleared during or following an OS Save sequence. The sequence is restarted the next time the OS Lock is set.

When the core power domain is powered down or when the OS Lock is not locked, reads of DBGOSSRR return an UNKNOWN value and writes are UNPREDICTABLE.

See *Example OS Save and Restore sequences* on page C6-12 for software examples of the OS Save and Restore processes.

The debug logic state preserved by the OS Save and Restore mechanism

If debug over power-down is supported, the OS Save and Restore mechanism permits the following debug logic state to be preserved:

- The registers that must be in the debug power domain, see *Power domains and debug* on page C6-5.
- The DBGWFAR.
- The DBGBVRs, DBGBCRs, DBGWVRs, DBGWCRs, and DBGVCR.
- The DBGDSCCR and DBGDSMCR.
- The data transfer registers DBGDTRTX and DBGDTRRX, subject to the values of DBGDSCR.TXfull and DBGDSCR.RXfull when the OS Save sequence is performed:
 - If DBGDSCR.TXfull is set to 1 then the value of DBGDTRTX is guaranteed to be saved and restored.
 - If DBGDSCR.RXfull is set to 1 then the value of DBGDTRRX is guaranteed to be saved and restored.
 - If either of these flags is not set to 1 when the OS Save sequence is performed then the value of the corresponding register is UNKNOWN after the OS Restore sequence.

————— **Note** —————

The OS Save and Restore sequences must not stall reading the values of DBGDTRTX and DBGDTRRX, and must not cause any instructions to be issued, regardless of the settings of the DBGDSCR.ExtDCCmode access mode bits.

- The DCC status flags themselves:
 - DBGDSCR.TXfull, bit [29]
 - DBGDSCR.TXfull_1, bit [26]
 - DBGDSCR.RXfull, bit [30]
 - DBGDSCR.RXfull_1, bit [27].

———— **Note** —————

Reading DBGDSCR through the DBGOSRRR has no side-effects, that is, the values of TXfull_1 and RXfull_1 are unchanged.

- All other writable flags in the DBGDSCR:
 - Method of Debug Entry bits, MOE, bits [5:2]
 - Force Debug Acknowledge bit, DBGack, bit [10]
 - Interrupts Disable bit, INTdis, bit [11]
 - User mode Access to Communication Channel Enable bit, UDCCdis, bit [12]
 - Execute ARM Instruction Enable bit, ITRen, bit [13]
 - Halting debug-mode Enable bit, HDBGen, bit [14]
 - Monitor debug-mode Enable bit, MDBGen, bit [15]
 - External DCC access mode field, ExtDCCmode, bits [21:20].
- ~~If vectored interrupt support is implemented and enabled, all state required to ensure the correct generation of Vector Catch debug events. For more information, see *Vector catch debug events and vectored interrupt support* on page C3-22.~~

The OS Save sequence must preserve at least all of this debug logic state that is lost when the core power domain is powered down. The OS Save sequence does not have to preserve any debug logic state that is not lost when the core power domain is powered down. That is, it does not have to preserve any debug logic state that is in the debug power domain.

The OS Save and Restore mechanism does not preserve:

- The sticky exception flags in the DBGDSCR, and the contents of the DBGITR.
- The read-only processor status flags in the DBGDSCR:
 - HALTED, bit [0]
 - RESTARTED, bit [1]
 - SPIDdis, bit [16]
 - SPNIDdis, bit [17]
 - NS, bit [18]
 - ADAdiscard, bit [19]
 - InstrCompl_1, bit [24]
 - PipeAdv, bit [25].

- The performance monitor registers described in Chapter C9 *Performance Monitors*.
- The trace registers.

The OS Restore sequence always overwrites the debug registers with the values that were saved. In particular, the values of the DBGDTRTX and DBGDTRRX Registers, and of the DCC status flags TXfull, TXfull_I, RXfull, and RXfull_I after the OS Restore sequence are the saved values.

If there were valid values in the DBGDTRTX or DBGDTRRX Registers immediately before the OS Restore sequence then those values are lost.

Example OS Save and Restore sequences

Example OS Save and Restore sequences are described in:

- *Example OS Save and Restore sequences using the memory-mapped interface*
- *Example OS Save and Restore sequences using the Extended CP14 interface* on page C6-14.

Example OS Save and Restore sequences using the memory-mapped interface

On an implementation that includes the OS Save and Restore mechanism and a memory-mapped interface:

- Example C6-1 shows the correct sequence for saving the debug logic state, using the memory-mapped interface, before powering down
- Example C6-2 on page C6-13 shows the correct sequence for restoring the debug logic state, using the memory-mapped interface, when the system is powered on again.

When the debug logic state is restored, if the OS Unlock Catch bit in the Event Catch Register is set to 1 a debug event is triggered when the DBGOSLAR is cleared. This event might be used by an external debugger to restart a debugging session. See *Event Catch Register (DBGECR)* on page C10-78.

Example C6-1 OS debug register save sequence, memory-mapped interface

; On entry, R0 points to a block to save the debug registers in.

SaveDebugRegisters

```

PUSH    {R4, LR}
MOV     R4, R0                ; Save pointer

; (1) Set OS Lock Access Register (DBGOSLAR). The architecture requires that DBGOSLAR
; and the other debug registers have at least the Device memory attribute.
BL      GetDebugRegisterBase  ; Returns base in R0
LDR     R1, =0xC5ACCE55
STR     R1, [R0, #0x300]      ; Write DBGOSLAR

; (2) Get the number of words to save.
LDR     R1, [R0, #0x308]      ; DBGOSRR returns size
STR     R1, [R4], #4          ; Push on to the save stack

; (3) Loop reading words from the DBGOSRR.
```



```

        CMP     R1, #0                ; Check for zero
SaveDebugRegisters_Loop
        ITTT   NE
        LDRNE  R2, [R0, #0x308]      ; Load a word of data
        STRNE  R2, [R4], #4          ; Push on to the save stack
        SUBSNE R1, R1, #1
        BNE    SaveDebugRegisters_Loop

; (4) Return the pointer to first word not written to. Leave DBGOSLAR set, because
;     from now on we do not want any changes.
        MOV    R0, R4
        POP    {R4, PC}

```

Example C6-2 OS debug register restore sequence, memory-mapped interface

; On entry, R0 points to a block of saved debug registers.

```

RestoreDebugRegisters
        PUSH   {R4, LR}
        MOV    R4, R0                ; Save pointer

; (1) Set the OS Lock Access Register (DBGOSLAR) and reset pointer. The lock
;     will already be set, but this write is needed to reset the pointer. The
;     architecture requires that DBGOSLAR and the other debug registers have at
;     least the Device memory attribute.
        BL     GetDebugRegisterBase  ; Returns base in R0
        LDR    R1, =0xC5ACCE55
        STR    R1, [R0, #0x300]      ; Write DBGOSLAR

; (2) Clear the Sticky Power-down Status bit.
        LDR    R1, [R0, #0x314]      ; Read DBGPRSR to clear StickyPD

; (3) Get the number of words saved.
        LDR    R1, [R0, #0x308]      ; Dummy read of DBGOSRRR
        LDR    R1, [R4], #4          ; Get register count from the save stack

; (4) Loop writing words from the DBGOSRRR.
        CMP    R1, #0                ; Check for zero
RestoreDebugRegisters_Loop
        ITTT   NE
        LDRNE  R2, [R4], #4          ; Load a word from the save stack
        STRNE  R2, [R0, #0x308]      ; Store a word of data
        SUBSNE R1, R1, #1
        BNE    RestoreDebugRegisters_Loop

; (5) Clear the DBGOSLAR. Writing any non-key value clears the lock, so use the
;     zero value in R1.
        STR    R1, [R0, #0x300]      ; Write DBGOSLAR

; (6) A final DSB ensures the restore is complete and an ISB ensures
;     the restored register values are visible to subsequent instructions.

```

```

DSB
ISB

; (7) Return the pointer to first word not read.
MOV    R0, R4
POP    {R4, PC}

```

Example OS Save and Restore sequences using the Extended CP14 interface

On an implementation that includes the OS Save and Restore mechanism and the Extended CP14 interface:

- Example C6-3 shows the correct sequence for saving the debug logic state, using the Extended CP14 interface, before powering down
- Example C6-4 on page C6-15 shows the correct sequence, using the Extended CP14 interface, for restoring the debug logic state when the system is powered on again.

When the debug logic state is restored, if the OS Unlock Catch bit in the Event Catch Register is set to 1 a debug event is triggered when the DBGOSLAR is cleared. This event might be used by an external debugger to restart a debugging session. See *Event Catch Register (DBGECR)* on page C10-78.

Example C6-3 OS debug register save sequence, Extended CP14 interface

; On entry, R0 points to a block to save the debug registers in.

```

SaveDebugRegisters
; (1) Set OS Lock Access Register (DBGOSLAR).
LDR    R1, =0xC5ACCE55
MCR    p14, 0, R1, c1, c0, 4      ; Write DBGOSLAR
ISB

; (2) Get the number of words to save.
MRC    p14, 0, R1, c1, c2, 4      ; DBGOSRR returns size
STR    R1, [R0], #4              ; Push on to the save stack

; (3) Loop reading words from the DBGOSRR.
CMP    R1, #0                    ; Check for zero
SaveDebugRegisters_Loop
ITTT   NE
MRCNE  p14, 0, R2, c1, c2, 4      ; Load a word of data
STRNE  R2, [R0], #4              ; Push on to the save stack
SUBSNE R1, R1, #1
BNE    SaveDebugRegisters_Loop

; (4) Return the pointer to first word not written to. This pointer is already in R0, so
;     all that is needed is to return from this function.
;
;     Leave DBGOSLAR set, because from now on we do not want any changes.
BX     LR

```

Example C6-4 OS debug register restore sequence, Extended CP14 interface

```

; On entry, R0 points to a block of saved debug registers.

RestoreDebugRegisters
    ; (1) Set OS Lock Access Register (DBGOSLAR) and reset pointer. The lock
    ;     will already be set, but this write is needed to reset the pointer.
    LDR    R1, =0xC5ACCE55
    MCR    p14, 0, R1, c1, c0, 4          ; Write DBGOSLAR
    ISB

    ; (2) Clear the Sticky Power-down Status bit.
    MRC    p14, 0, R1, c1, c5, 4          ; Read DBGPRSR to clear StickyPD
    ISB

    ; (3) Get the number of words saved.
    MRC    p14, 0, R1, c1, c2, 4          ; Dummy read of DBGOSRRR
    LDR    R1, [R0], #4                   ; Load size from the save stack

    ; (4) Loop writing words from the DBGOSRRR.
    CMP    R1, #0                          ; Check for zero
RestoreDebugRegisters_Loop
    ITTT   NE
    LDRNE  R2, [R0], #4                     ; Load a word from the save stack
    MCRNE  p14, 0, R2, c1, c2, 4           ; Store a word of data
    SUBSNE R1, R1, #1
    BNE    RestoreDebugRegisters_Loop

    ; (5) Clear the OS Lock Access Register (DBGOSLAR). Writing any non-key value
    ;     clears the lock, so use the zero value in R1.
    ISB
    MCR    p14, 0, R1, c1, c0, 4          ; Write DBGOSLAR

    ; (6) A final ISB guarantees the restored register values are visible to subsequent
    ;     instructions.
    ISB

    ; (7) Return the pointer to first word not read. This pointer is already in R0, so
    ;     all that is needed is to return from this function.
    BX    LR

```

C6.2.4 Recommended reset scheme for v7 Debug

The processor reset scheme is IMPLEMENTATION DEFINED. The ARM architecture, described in parts A and B of this manual, does not distinguish different levels of reset. However, in a typical system, there are a number of reasons why multiple levels of reset might exist. In particular, for debug:

- It is desirable to be able to debug the reset sequence. This requires support for:
 - setting the debug register values before performing a processor reset
 - a processor reset not resetting the debug register values.
- Providing separate power domains means you might need to reset the debug logic independently from the logic in the core power domain.

For these reasons, v7 Debug introduces a distinction between *debug logic reset* and *non-debug logic reset*. These resets can be applied independently. The reset descriptions in parts A and B of this manual describe the non-debug logic reset. Part C describes the debug logic reset and its interaction with the non-debug logic reset. The non-debug logic reset is sometimes referred to as a *core logic reset*.

ARM recommends use of the following reset signals for an implementation that supports these independent resets:

nSYSPORESET	This signal must be driven LOW on power-up of both the core and debug power domains. It sets parts of the processor logic, including debug logic, to a known state.
nCOREPORESET	If the core power domain is powered down while the system is still powered up, this signal must be driven LOW when the core power domain is powered back up. It sets parts of the processor logic in the core power domain to a known state. Also, this reset initializes the debug registers that are in the core power domain.
nRESET	This signal is driven LOW to generate a warm reset, that is, when the system wants to set the processor to a known state but the reset has nothing to do with any power-down, for example a watchdog reset. It sets parts of the non-debug processor logic to a known state. A debug session must be unaffected by this reset.
PRESETDBGn	The debugger drives this signal LOW to set parts of the debug logic to a known state. This signal must be driven LOW on power-up of the debug logic.

v6 Debug and v6.1 Debug systems do not support multiple power domains and therefore ARM recommends a less flexible reset scheme, consisting of only **nSYSPORESET** and **nRESET**. The debug logic is reset only on **nSYSPORESET** and has no independent reset signal.

In the v7 Debug recommended reset scheme, a separate **PRESETDBGn** reset signal can be asserted at any time, not just at power-up. This new signal has similar effects to **nSYSPORESET**, that is, it clears all debug registers, unless otherwise noted by the register definition. For more information, see Appendix A *Recommended External Debug Interface*.

Asynchronously asserting **PRESETDBGn** can lead to UNPREDICTABLE behavior. For example, the reset might change the values of debug registers that are in use or will be used by software.

For more information about this reset scheme, contact ARM.

Table C6-1 summarizes the v7 Debug recommended reset scheme.

Table C6-1 Recommended reset scheme, v7 Debug

Signal	Debug power domain		Core power domain	
	Debug logic	Debug logic	Debug logic	Non-debug logic
nSYSPORESET	Reset		Reset ^a	Reset
nCOREPORESET	Not reset		Reset ^a	Reset
nRESET	Not reset		Not reset	Reset
PRESETDBGn	Reset		Reset ^a	Not reset

- a. If the core power domain is not powered, or the Sticky Power-down status bit **DBGPRSR[1]** is set to 1, it is UNPREDICTABLE whether the registers are reset. If power is not applied to the core power domain, **nCOREPORESET** must be driven LOW when power is restored to the core power domain. This resets these registers.

For ARMv7 SinglePower systems, ARM recommends only **nSYSPORESET**, **nRESET**, and **PRESETDBGn**.

Debug behavior when the processor is in debug logic reset

The implementation of separate debug and core power domains with a separate debug logic reset signal means that a processor can access debug registers and the DCC while in the debug logic reset state. When in debug logic reset:

- The behavior of the DCC is UNPREDICTABLE. In particular, the values of the **DBGDSCR.RXfull** and **DBGDSCR.TXfull** flags are UNKNOWN.
- It is UNPREDICTABLE whether a debug event that would have been generated by the state of the debug logic immediately before the debug logic reset is generated.
- The debug logic must not generate any debug event that would not have been generated if the system was not in debug logic reset.
- Accesses to the debug registers through the Extended CP14, memory-mapped and external debug interfaces are UNPREDICTABLE.

C6.3 Debug register map

Table C6-2 lists all of the debug registers. Full details of each register can be found in the referenced section.

The number of DBGBVR/DBGBCR and DBGWVR/DBGWCR pairs is IMPLEMENTATION DEFINED, see the BRPs and WRPs fields of the *Debug ID Register (DBGDIDR)* on page C10-3. An implementation can have up to 16 of each.

The interpretation of the information in the *Access* column depends on whether the coprocessor or memory-mapped interface is used to access the register.

Collectively, registers 832-1023 are known as the management registers.

Table C6-2 Debug register map

Register number	Offset	Access ^a	Versions ^b	Name and reference to description
0	0x000	Read-only	All	<i>Debug ID Register (DBGDIDR)</i> on page C10-3.
Not applicable ^c	-	Read-only	v7 only	<i>Debug ROM Address Register (DBGDRAR)</i> on page C10-7.
Not applicable ^c	-	Read-only	v7 only	<i>Debug Self Address Offset Register (DBGDSAR)</i> on page C10-8.
1-5	-	-	-	Reserved.
6	0x018	Read/write	v7 ^d	<i>Watchpoint Fault Address Register (DBGWFAR)</i> on page C10-28.
7	0x01C	Read/write	All	<i>Vector Catch Register (DBGVCR)</i> on page C10-67.
8	-	-	-	Reserved.
9	0x024	Read/write	v7 only	<i>Event Catch Register (DBGECCR)</i> on page C10-78.
10	0x028	Read/write	v6.1, v7	<i>Debug State Cache Control Register (DBGDSCCR)</i> on page C10-81.
11	0x02C	Read/write	v6.1, v7	<i>Debug State MMU Control Register (DBGDSMCR)</i> on page C10-84.
12-31	-	-	-	Reserved.
32	0x080	Read/write	v7 ^e	DBGDTRRX external view ^f . See <i>Host to Target Data Transfer Register (DBGDTRRX)</i> on page C10-40.

Table C6-2 Debug register map (continued)

Register number	Offset	Access ^a	Versions ^b	Name and reference to description
33	0x084	Write-only	v7 ^c	<i>Instruction Transfer Register (DBGITR)</i> on page C10-46.
		Read-only	v7 ^c	<i>Program Counter Sampling Register (DBGPCSR)</i> on page C10-38.
34	0x088	Read/write	v7 ^c	DBGDSCR external view ^f . See <i>Debug Status and Control Register (DBGDSCR)</i> on page C10-10.
35	0x08C	Read/write	v7 ^c	DBGDTRTX external view ^f . See <i>Target to Host Data Transfer Register (DBGDTRTX)</i> on page C10-43.
36	0x090	Write-only	v7 only	<i>Debug Run Control Register (DBGDRCR)</i> , v7 <i>Debug only</i> on page C10-29.
37-39	-	-	-	Reserved.
40	0x0A0	Read-only	v7 only	<i>Program Counter Sampling Register (DBGPCSR)</i> on page C10-38
41	0x0A4	Read-only	v7 only	<i>Context ID Sampling Register (DBGCIDSR)</i> on page C10-39
42-63	-	-	-	Reserved.
64-79	0x100- 0x13C	Read/write or -	All	<i>Breakpoint Value Registers (DBGBVR)</i> on page C10-48 or Reserved.
80-95	0x140- 0x17C	Read/write or -	All	<i>Breakpoint Control Registers (DBGBCR)</i> on page C10-49 or Reserved.
96-111	0x180- 0x1BC	Read/write or -	All	<i>Watchpoint Value Registers (DBGWVR)</i> on page C10-60 or Reserved.
112-127	0x1C0- 0x1FC	Read/write or -	All	<i>Watchpoint Control Registers (DBGWCR)</i> on page C10-61 or Reserved.
128-191	-	-	-	Reserved.
192	0x300	Write-only	v7 only	<i>OS Lock Access Register (DBGOSLAR)</i> on page C10-75.
193	0x304	Read-only	v7 only	<i>OS Lock Status Register (DBGOSLSR)</i> on page C10-76.
194	0x308	Read/write	v7 only	<i>OS Save and Restore Register (DBGOSSRR)</i> on page C10-77.

Table C6-2 Debug register map (continued)

Register number	Offset	Access ^a	Versions ^b	Name and reference to description
195	-	-	-	Reserved.
196	0x310	Read/write	v7 only	<i>Device Power-down and Reset Control Register (DBGPRCR)</i> , v7 <i>Debug only</i> on page C10-31.
197	0x314	Read-only	v7 only	<i>Device Power-down and Reset Status Register (DBGPRSR)</i> , v7 <i>Debug only</i> on page C10-34.
198-511	-	-	-	Reserved.
512-575	0x800-0x8FC	-	v7 only	IMPLEMENTATION DEFINED.
576-831	-	-	-	Reserved.
832-895	0xD00-0xDFC	Read-only	v7 only	<i>Processor identification registers</i> on page C10-88.
896-927	-	-	-	Reserved.
928-959	0xE80-0xEFC	-	v7 only	IMPLEMENTATION DEFINED integration registers. See the <i>CoreSight Architecture Specification</i> .
960	0xF00	Read/write	v7 only	<i>Integration Mode Control Register (DBGITCTRL)</i> on page C10-91.
961-999	0xF04-0xF9C	-	v7 only	Reserved for management registers expansion.
1000	0xFA0	Read/write	v7 only	<i>Claim Tag Set Register (DBGCLAIMSET)</i> on page C10-92.
1001	0xFA4	Read/write	v7 only	<i>Claim Tag Clear Register (DBGCLAIMCLR)</i> on page C10-93.
1002-1003	-	-	-	Reserved.
1004	0xFB0	Write-only	v7 only	<i>Lock Access Register (DBGLAR)</i> on page C10-94.
1005	0xFB4	Read-only	v7 only	<i>Lock Status Register (DBGLSR)</i> on page C10-95.
1006	0xFB8	Read-only	v7 only	<i>Authentication Status Register (DBGAUTHSTATUS)</i> on page C10-96.
1007-1009	-	-	-	Reserved.

Table C6-2 Debug register map (continued)

Register number	Offset	Access ^a	Versions ^b	Name and reference to description
1010	0xFC8	Read-only	v7 only	<i>Debug Device ID Register (DBGDEVID)</i> on page C10-6.
1011	0xFCC	Read-only	v7 only	<i>Device Type Register (DBGDEVTYPE)</i> on page C10-98.
1012-1019	0xFD0-0xFEC	Read-only	v7 only	<i>Debug Peripheral Identification Registers (DBGPID0 to DBGPID4)</i> on page C10-98.
1020-1023	0xFF0-0xFFC	Read-only	v7 only	<i>Debug Component Identification Registers (DBGCID0 to DBGCID3)</i> on page C10-102.

- For more information, see *CP14 debug registers access permissions* on page C6-36 and *Permission summaries for memory-mapped and external debug interfaces* on page C6-45.
- An entry of *All* in the *Versions* column indicates that the register is implemented in v6 Debug, v6.1 Debug, and v7 Debug.
- These registers are only implemented through the Baseline CP14 interface and do not have register numbers or offsets.
- The method of accessing the DBGWFAR is different in v6 Debug, v6.1 Debug and v7 Debug. For details see *Watchpoint Fault Address Register (DBGWFAR)* on page C10-28.
- In v6 Debug and v6.1 Debug, ARM recommends these registers as part of the external debug interface, and are not implemented through the Extended CP14 interface. In v7 Debug these registers are required.
- Internal views of the DBGDTRRX, DBGDTRTX, and DBGDSCR are implemented through the Baseline CP14 interface. This is explained in *Internal and external views of the DBGDSCR and the DCC registers*.

C6.3.1 Internal and external views of the DBGDSCR and the DCC registers

For each of the three registers DBGDSCR, DBGDTRTX and DBGDTRRX there are two views, denoted by *int* and *ext* suffixes. The differences between these aliases relate to the handling of the *Debug Communications Channel (DCC)*, and in particular the *TXfull* and *RXfull* status flags. The nomenclature *internal* and *external* derives from the intended usage model.

Accesses to DBGDSCRint, DBGDTRRXint or DBGDTRTXint are always made through the Baseline CP14 interface described in *The Baseline CP14 debug register interface* on page C6-32. DBGDSCRint is read-only in v7 Debug.

Accesses to DBGDSCRext, DBGDTRRXext or DBGDTRTXext can be made through:

- the Extended CP14 interface, if implemented
- the memory-mapped interface, if implemented
- the external debug interface.

However, if at any given time you attempt to access the DBGDSCRext, DBGDTRRXext and DBGDTRTXext registers through more than one interface the behavior is UNPREDICTABLE. If an implementation provides a single port to handle external debug interface and the memory-mapped interface

accesses, that port might serialize accesses to the registers from the two interfaces. However, the effects of reads and writes to these registers are such that the behavior observed from either interface appears as UNPREDICTABLE.

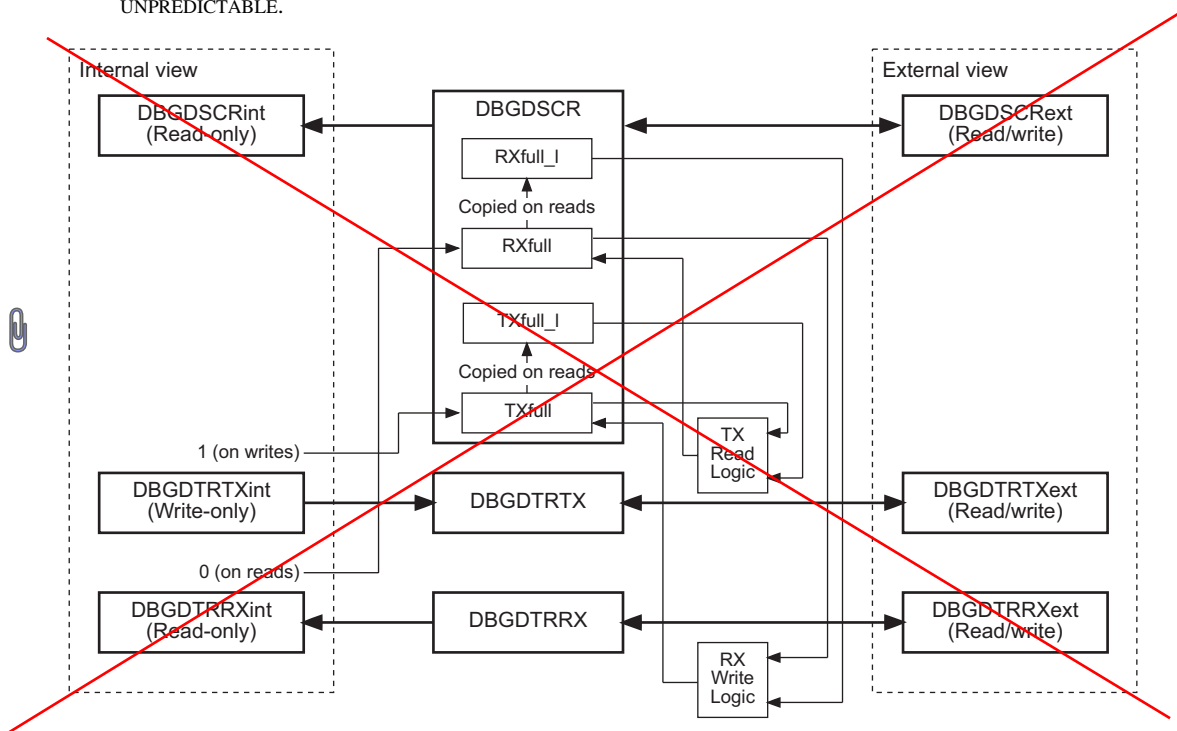

Figure C6-2 v7 Debug Internal (int) and External (ext) views of the DCC registers

Note

- **DBGDSCRint** and **DBGDSCRext** only provide different views onto the underlying **DBGDSCR**
- **DBGDTRRXint** and **DBGDTRRXext** only provide different views onto the underlying **DBGDTRRX** Register
- **DBGDTRTXint** and **DBGDTRTXext** only provide different views onto the underlying **DBGDTRTX** Register.

See also:

- *Debug Status and Control Register (DBGDSCR)* on page C10-10
- *Host to Target Data Transfer Register (DBGDTRRX)* on page C10-40
- *Target to Host Data Transfer Register (DBGDTRTX)* on page C10-43.

C6.3.2 Effect of the Security Extensions on the debug registers

When the Security Extensions are implemented, all debug registers are Common registers, meaning they are common to the Secure and Non-secure states. For more information, see *Common CP15 registers* on page B3-74.

C6.4 Synchronization of debug register updates

Software running on the processor can program the debug registers through at least one of:

- a CP14 coprocessor interface
- the memory-mapped interface, if it is implemented.

It is IMPLEMENTATION DEFINED which interfaces are implemented.

For the CP14 coprocessor interface, the following synchronization rules apply:

- All changes to CP14 debug registers that appear in program order after any explicit memory operations are guaranteed not to affect those memory operations.
- Any change to CP14 debug registers is guaranteed to be visible to subsequent instructions only after one of:
 - performing an ISB operation
 - taking an exception
 - returning from an exception.

However, for CP14 coprocessor register accesses, all MRC and MCR instructions to the same register using the same register number appear to occur in program order relative to each other without context synchronization.

For the memory-mapped interface, the following synchronization rules apply:

- All memory-mapped debug registers must be mapped to Strongly-ordered or Device memory, otherwise the effect of any access to the memory-mapped debug registers is UNPREDICTABLE.
- Changes to memory-mapped debug registers that appear in program order after an explicit memory operation are guaranteed not to affect that previous memory operation only if the order is guaranteed by the memory order model or by the use of a DMB or DSB operation between the memory operation and the register change.
- A DSB operation causes all writes to memory-mapped debug registers appearing in program order before the DSB to be completed.
- With respect to other accesses by the same processor to the memory-mapped debug registers, all accesses to memory-mapped debug registers have their effect in the order in which the accesses occur, as governed by the memory order model and the use of DSB and DMB operations.
- ~~All accesses to memory-mapped debug registers that are completed are only guaranteed to affect subsequent instructions after one of:~~
 - ~~— performing an ISB operation~~
 - ~~— taking an exception~~
 - ~~— returning from an exception.~~

Some memory-mapped debug registers are not idempotent for reads or writes. Therefore, the region of memory occupied by the debug registers must not be marked as Normal memory, because the memory order model permits accesses to Normal memory locations that are not appropriate for such registers.

Synchronization between register updates made through the external debug interface and updates made by software running on the processor is IMPLEMENTATION DEFINED. However, if the external debug interface is implemented through the same port as the memory-mapped interface, then updates made through the external debug interface have the same properties as updates made through the memory-mapped interface.

C6.5 Access permissions

This section describes the basic concepts of the access permissions model for debug registers on ARMv7 processors. The actual rules for each interface, and for ARMv6 implementations, are given in the section describing the register interface:

- *CP14 debug registers access permissions* on page C6-36
- *Permission summaries for memory-mapped and external debug interfaces* on page C6-45.

The restrictions for accessing the registers can be divided into three categories:

Privilege of the access

Accesses from processors in the system to the memory-mapped registers, and accesses to coprocessor registers, can be required to be privileged.

Locks Can be used to lock out different parts of the register map so they cannot be accessed.

Power-down Access to registers in the core power domain is not possible when that domain is powered down.

When permission to access a register is not granted, an error is returned. The nature of this error depends on the interface:

- For coprocessor interfaces, the error is an Undefined Instruction exception
- For the memory-mapped interface, the error is a slave-generated error response, for example **PSLVERRDBG**. The error is normally signaled to the processor as an external abort.
- For the external debug interface, the error is signaled to the debugger by the Debug Access Port.

Holding the processor in warm reset, whether by using an external warm reset signal or by using the Device Power-down and Reset Control Register (DBGPRCR), does not affect the behavior of the memory-mapped or external debug interface.

The Hold non-debug reset control bit of the DBGPRCR enables an external debugger to keep the processor in warm reset while programming other debug registers. For details see *Device Power-down and Reset Control Register (DBGPRCR), v7 Debug only* on page C10-31.

C6.5.1 Permissions in relation to the privilege of the access

The majority of debug registers can only be accessed by privileged code. The exception to this general requirement is a small subset of the registers, defined in *The Baseline CP14 debug register interface* on page C6-32. Using the coprocessor interface, privileged code can disable User mode access to this subset of registers.

For the memory-mapped interface, it is IMPLEMENTATION DEFINED whether restricting debug register access to privileged code is implemented by the processor or must be implemented by the system designer at the system level. The behavior of an access that is not permitted is IMPLEMENTATION DEFINED, however it must either be ignored or aborted.

Note

- The recommended memory-mapped interface port is based on the AMBA® Advanced Peripheral Bus (APBv3), that does not support signaling of access privileges. Therefore in this case the system must prevent the access.
 - This access restriction applies to the privilege of the initiator of the access, not the current mode of the processor being accessed. The privilege of accesses made by a Debug Access Port is IMPLEMENTATION DEFINED.
-

The system designer can impose additional restrictions. However, ARM strongly recommends that designers do not impose restrictions such as only permitting Secure privileged accesses, and does not support such restrictions in its debug tools.

C6.5.2 Permissions in relation to locks

The registers can be locked by a debugger or by an operating system so that access to debug registers is restricted.

There are three locks, although some of these locks only apply to certain interfaces:

Software Lock

The Software Lock only applies to accesses made through the memory-mapped interface.

By default, software is locked out so the debug registers settings cannot be modified. A debug monitor must leave this lock set when not accessing the debug registers, to reduce the chance of erratic code modifying debug settings. When this lock is set, writes to the debug registers from the memory-mapped interface are ignored. For more information about this lock, see *Lock Access Register (DBGLAR)* on page C10-94 and *Lock Status Register (DBGLSR)* on page C10-95.

OS Lock

An OS must set this lock on the debug registers before starting an OS Save or Restore sequence, so that the debug registers cannot be read or written during the sequence. When this lock is set, accesses to some registers return errors. Only the OS Save and Restore mechanism registers can be accessed safely.

Note

An external debugger can clear this lock at any time, even if an OS Save or Restore operation is in progress.

For more information about this lock, see *OS Lock Access Register (DBGOSLAR)* on page C10-75 and *OS Lock Status Register (DBGOSLSR)* on page C10-76.

Debug Software Enable

An external debugger can use the Debug Software Enable function to prevent modification of the debug registers by a debug monitor or other software running on the system. The Debug Software Enable is a required function of the Debug Access Port, and is implemented as part of the ARM Debug Interface v5. For more information see the *ARM Debug Interface v5 Architecture Specification*.

See also *DBGSWENABLE* on page AppxA-11.

Note

- The states of the Software Lock and the OS Lock are held in the debug power domain, and the Debug Software Enable is in the Debug Access Port. Therefore, these locks are unaffected by the core power domain powering down. Also, all of these locks are set to their reset values only on reset of the debug power domain, that is, on a **PRESETDBGn** or **nSYSPORESET** reset.
- On SinglePower systems, the Software Lock and OS Lock are lost over a power-down. It is IMPLEMENTATION DEFINED whether the single processor power-domain also includes the Debug Access Port, and therefore also whether the Debug Software Enable is lost over a power-down.

C6.5.3 Permissions in relation to power-down

Accesses cannot be made through the coprocessor interface when the core power domain is powered down.

Access to registers in the core power domain is not possible when the domain is powered down, and accesses return an error response.

Note

Returning this error response, rather than simply ignoring writes, means that the debugger and the debug monitor detect the debug session interruption as soon as it occurs. This makes re-starting the session, after power-up, considerably easier.

When the core power domain powers down, the Sticky Power-down status bit, bit [1] of the Device Power-down and Reset Status Register, is set to 1. This bit remains set to 1 until it is cleared to 0 by a read of this register after the core power domain has powered up. If the register is read while the core power domain is still powered down, the bit remains set to 1. When this bit is 1 the behavior is as if the core power domain is powered down, meaning the processor ignores accesses to registers inside the core power domain and the system returns an error. This applies whether the register is accessed through the Extended CP14 interface, the memory-mapped interface, or the external debug interface.

This behavior is useful because when the external debugger tries to access a register whose contents might have been lost by a power-down, it gets the same response regardless of whether the core power domain is currently powered down or has powered back up. This means that, if the external debugger does not access the external debug interface during the window where the core power domain is powered down, the processor still reports the occurrence of the power-down event.

Access to all debug registers is not possible if the debug logic is powered down. In this situation:

- the system must respond to any access made through the memory-mapped or external debug interface when the debug power domain is powered down, and ARM recommends that the system generates an error response
- accesses through the coprocessor interface are UNPREDICTABLE.

The debug logic is powered down:

- when the debug power domain is powered down, in an implementation with separate debug and core power domains
- when the processor is powered down, in a SinglePower implementation.

C6.5.4 Access to IMPLEMENTATION DEFINED and reserved registers

The following subsections describe the responses to accesses to IMPLEMENTATION DEFINED and reserved registers:

- *Access to implementation defined registers*
- *Access to reserved registers* on page C6-30.

———— Note —————

There are no IMPLEMENTATION DEFINED or reserved registers in the Baseline CP14 interface and therefore these sections do not say anything about accesses through the Baseline CP14 interface.

Any unused registers in the spaces for IMPLEMENTATION DEFINED registers must behave as reserved registers. These spaces are register numbers 512-575 and 928-959.

Access to IMPLEMENTATION DEFINED registers

When the Debug Software Enable function, described in *Permissions in relation to locks* on page C6-27, is disabling software access to the debug registers, Table C6-3 shows how the response to an accesses to an IMPLEMENTATION DEFINED register depends on the debug interface used for the access.

Table C6-3 Accesses to IMPLEMENTATION DEFINED registers when Debug Software Enable disables access

Debug interface used for access ^a	Response
Memory-mapped interface	Error response
Extended CP14 interface	Undefined Instruction exception
External debug interface	IMPLEMENTATION DEFINED

a. There are no IMPLEMENTATION DEFINED registers in the Baseline CP14 interface.

If the Debug Software Enable function is not disabling software access to the debug registers, the response to any access to an IMPLEMENTATION DEFINED register is IMPLEMENTATION DEFINED. This means the response is IMPLEMENTATION DEFINED if any of the following apply:

- the core power domain is powered-down
- the Sticky Powered-down Status bit is set to 1
- the OS Lock is implemented and is locked
- the attempted access is using the memory-mapped interface and the Software Lock is locked.

Note

The IMPLEMENTATION DEFINED registers include the IMPLEMENTATION DEFINED integration registers, register numbers 928-959.

Access to reserved registers

The response to an access to a reserved register depends on the interface you are using to attempt the access, as follows:

Memory-mapped interface

When the Debug Software Enable function, described in *Permissions in relation to locks* on page C6-27, is disabling software access to the debug registers, any access to a reserved register through the memory-mapped interface returns an error response. This includes accesses to reserved registers in the management registers space, register numbers 832-1023.

When the Debug Software Enable function is not disabling software access to the debug registers:

- Reserved registers in the management registers space, except for reserved registers in the IMPLEMENTATION DEFINED integration registers space, are UNK/SBZP.
- For all other reserved registers, it is UNPREDICTABLE whether a register access returns an error response if any of the following applies:
 - the core power domain is powered-down
 - the Sticky Powered-Down Status bit is set to 1
 - the OS Lock is implemented and is locked
 - the Software Lock is locked.

If none of these applies then these reserved registers are UNK/SBZP.

Extended CP14 interface

In v6 Debug and v6.1 Debug, any attempt to access a reserved register causes an Undefined Instruction exception.

In v7 Debug:

- When the Debug Software Enable function is disabling software access to the debug registers, any attempt to access a reserved register causes an Undefined Instruction exception.

- When the Debug Software Enable function enables software access to the debug registers, any attempt to access a reserved register:
 - causes an Undefined Instruction exception if the access is from User mode
 - is UNPREDICTABLE if the access is from a privileged mode.

External debug interface

Reserved registers in the management registers space, except for reserved registers in the IMPLEMENTATION DEFINED integration registers space, are UNK/SBZP.

For all other reserved registers:

- It is UNPREDICTABLE whether a register access returns an error response if any of the following applies:
 - the core power domain is powered-down
 - the Sticky Powered-Down Status bit is set to 1
 - the OS Lock is implemented and is locked.
- If none of these applies then these reserved registers are UNK/SBZP.

———— **Note** —————

- There are no reserved registers in the Baseline CP14 interface.
 - Unimplemented breakpoint and watchpoint registers are reserved registers.
-

C6.6 The CP14 debug register interfaces

This section contains the following subsections:

- *The Baseline CP14 debug register interface*
- *Extended CP14 interface* on page C6-33
- *CP14 debug registers access permissions* on page C6-36.

C6.6.1 The Baseline CP14 debug register interface

Table C6-4 lists the set of CP14 debug instructions for accessing the debug registers that must be implemented.

All MRC and MCR instructions with $\langle\text{coproc}\rangle = 0b1110$ and $\langle\text{opc1}\rangle = 0b000$ are debug instructions:

- Some of these instructions are defined in Table C6-4.
- Additional instructions are defined in *Extended CP14 interface* on page C6-33
- All other instructions are reserved for use by the Debug architecture. The behavior of reserved instructions is defined in *CP14 debug registers access permissions* on page C6-36.

All MRC and MCR instructions with $\langle\text{coproc}\rangle = 0b1110$ and $\langle\text{opc1}\rangle = 0b001$ are used by the trace extension. Other values of $\langle\text{opc1}\rangle$ are not used by the Debug architecture.

All LDC and STC instructions with $\langle\text{coproc}\rangle = 0b1110$ that are not listed below are reserved for use by the Debug architecture and are currently UNDEFINED. All CDP, MRC2, MCR2, LDC2, STC2, LDCL, STCL, LDC2L, and STC2L instructions with $\langle\text{coproc}\rangle = 0b1110$ are UNDEFINED.

Instructions that access registers that are only available in v7 Debug are UNDEFINED in earlier versions of the Debug architecture. For example, the read from DBGDRAR performed by $\text{MRC } p14, 0, \langle\text{Rt}\rangle, c1, c0, 0$ is UNDEFINED in v6 Debug and v6.1 Debug, but is permitted in v7 Debug.

$\langle\text{Rt}\rangle$ refers to any of the general-purpose registers R0-R14. Use of APSR_nzcv is UNPREDICTABLE except where stated. Use of R13 is UNPREDICTABLE in Thumb and ThumbEE state, and is deprecated in ARM state.

Table C6-4 Baseline CP14 debug instructions

Instruction	Mnemonic	Version	Name and reference to description
$\text{MRC } p14, 0, \langle\text{Rt}\rangle, c0, c0, 0$	DBGDIDR	All	<i>Debug ID Register (DBGDIDR)</i> on page C10-3
$\text{MRC } p14, 0, \langle\text{Rt}\rangle, c1, c0, 0$	DBGDRAR	v7 only	<i>Debug ROM Address Register (DBGDRAR)</i> on page C10-7
$\text{MRC } p14, 0, \langle\text{Rt}\rangle, c2, c0, 0$	DBGDSAR	v7 only	<i>Debug Self Address Offset Register (DBGDSAR)</i> on page C10-8

Table C6-4 Baseline CP14 debug instructions (continued)

Instruction	Mnemonic	Version	Name and reference to description
MRC p14, 0, <Rt>, c0, c5, 0 STC p14, c5, <addr_mode>	DBGDTRRXint	All ^a	DBGDTRRX internal view. See <i>Host to Target Data Transfer Register (DBGDTRRX)</i> on page C10-40
MCR p14, 0, <Rt>, c0, c5, 0 LDC p14, c5, <addr_mode>	DBGDTRTXint	All ^a	DBGDTRTX internal view. See <i>Target to Host Data Transfer Register (DBGDTRTX)</i> on page C10-43
MRC p14, 0, <Rt>, c0, c1, 0 MRC p14, 0, APSR_nzcv, c0, c1, 0 ^b	DBGDSCRint	All ^a	DBGDSCR internal view. See <i>Debug Status and Control Register (DBGDSCR)</i> on page C10-10

- a. For more information, see the register description.
- b. DBGDSCR[31:28] are transferred to the N, Z, C and V condition flags. For more information, see *Program Status Registers (PSRs)* on page B1-14.

C6.6.2 Extended CP14 interface

The architectural requirements for the Extended CP14 interface depend on the Debug architecture version:

v6 Debug and v6.1 Debug

All debug registers can be accessed through CP14, and implementations must provide an external access mechanism for debuggers. The details of this mechanism are not covered by the architecture specification. See *Features specific to v6 Debug and v6.1 Debug* on page C6-35.

v7 Debug

The Extended CP14 interface to the debug registers is optional.

The Baseline CP14 interface is sufficient to boot-strap access to the register file, and enables software to distinguish between the Extended CP14 and memory-mapped interfaces.

See *Features specific to v7 Debug* on page C6-34.

If the Extended CP14 interface is not implemented, the memory-mapped interface must be implemented. See section *The memory-mapped and recommended external debug interfaces* on page C6-43.

———— Note —————

This section does not apply to a v7 Debug implementation that does not implement the Extended CP14 interface.

The full list of debug registers is given in Table C6-2 on page C6-18 and is not repeated here.

With some exceptions, listed in *Features specific to v7 Debug* and *Features specific to v6 Debug and v6.1 Debug* on page C6-35, all the debug registers, including those in the IMPLEMENTATION DEFINED space, are accessed by the following coprocessor instructions, with <CRn> <= 0b0111 and the mapping shown in Figure C6-3:

- MRC p14,0,<Rt>,<CRn>,<CRm>,<opc2> ; Read
- MCR p14,0,<Rt>,<CRn>,<CRm>,<opc2> ; Write

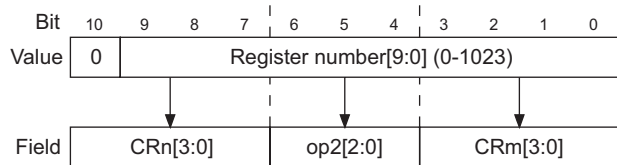

Figure C6-3 Mapping from register number to CP14 instruction

For example, the instruction:

```
MRC p14,0,<Rt>,c0,c0,5
```

reads the value of DBGBCR0, that is register 80, 0b0001010000.

Features specific to v7 Debug

Table C6-5 lists the exceptions, in the v7 Debug Extended CP14 interface, to the standard mapping. In the v7 Debug Extended CP14 interface, all the instructions are UNDEFINED in User mode and UNPREDICTABLE in privileged modes.

Table C6-5 Exceptions to the standard mapping, v7 Debug with Extended CP14 interface

Register number	Name	Access	Standard mapping
33	Program Counter Sampling Register	Read-only	MRC p14,0,<Rt>,c0,c1,2
	Instruction Transfer Register	Write-only	MCR p14,0,<Rt>,c0,c1,2
40	Program Counter Sampling Register	Read-only	MRC p14,0,<Rt>,c0,c8,2
41	Context ID Sampling Register	Read-only	MRC p14,0,<Rt>,c0,c9,2
832-895	Processor identification registers	Read-only	MRC p14,0,<Rt>,c6,c0,4 to MRC p14,0,<Rt>,c6,c15,7
1004	Lock Access Register	Write-only	MCR p14,0,<Rt>,c7,c12,6
1005	Lock Status Register	Read-only	MRC p14,0,<Rt>,c7,c13,6

Accesses to the external views DBGDSCRExt, DBGDTRRXext and DBGDTRTXext can be made through the standard mapping of these registers, in addition to the instructions to access the internal views DBGDSCRint, DBGDTRRXint and DBGDTRTXint provided in the Baseline CP14 interface. See *Internal and external views of the DBGDSCR and the DCC registers* on page C6-21.

Features specific to v6 Debug and v6.1 Debug

Table C6-6 lists the exceptions, in the Extended CP14 interface in v6 Debug and v6.1 Debug, to the standard mapping. All the instructions listed are UNDEFINED in ARMv6.

Table C6-6 Exceptions to the standard mapping, v6 Debug and v6.1 Debug

Register number	Name	Access	Standard mapping, all UNDEFINED
32	Host to Target Data Transfer Register	Read/write	MRC p14,0,<Rt>,c0,c0,2
			MCR p14,0,<Rt>,c0,c0,2
33	Program Counter Sampling Register	Read-only	MRC p14,0,<Rt>,c0,c1,2
	Instruction Transfer Register	Write-only	MCR p14,0,<Rt>,c0,c1,2
34	Debug Status and Control Register	Read/write	MRC p14,0,<Rt>,c0,c2,2
			MCR p14,0,<Rt>,c0,c2,2
35	Target to Host Data Transfer Register	Read/write	MRC p14,0,<Rt>,c0,c3,2
			MCR p14,0,<Rt>,c0,c3,2

See also footnote ^e on Table C6-2 on page C6-18, regarding registers 32, 33, 34, and 35.

In v6 Debug and v6.1 Debug, no debug registers map to CP14 instructions with <CRn> != 0b0000. All instruction encodings with <CRn> != 0b0000 and <opc1> = 0 are UNDEFINED in User mode and UNPREDICTABLE in privileged modes. All reserved encodings with <CRn> = 0b0000 are UNDEFINED in all modes.

Table C6-7 defines an additional ARMv6 instruction for making an internal access write to the DBGDSCR.

Table C6-7 Additional ARMv6 CP14 debug instruction

Instruction	Mnemonic	Name
MCR p14,0,<Rt>,c0,c1,0	DBGDSCRint	<i>Debug Status and Control Register (DBGDSCR)</i> on page C10-10

C6.6.3 CP14 debug registers access permissions

By default, certain CP14 debug registers can be accessed from User mode. However, the processor can be programmed to prevent User mode access to these CP14 debug registers. For more information, see the description of the UDCCdis bit in *Debug Status and Control Register (DBGDSCR)* on page C10-10.

All CP14 debug registers can be accessed if the processor is in Debug state.

———— **Note** —————

When the Software Lock (DBGLAR) is implemented for a memory-mapped interface, it does not affect the behavior of CP14 instructions.

Baseline CP14 debug registers access permissions

Access to the Baseline CP14 debug registers is governed by the processor mode, Debug state and the value of DBGDSCR.UDCCdis. In addition, when the OS Lock is set accesses to the baseline registers are UNPREDICTABLE.

———— **Note** —————

OS Lock is implemented only in v7 Debug.

These access permissions are shown:

- in Table C6-8 for v6 Debug and v6.1 Debug
- in Table C6-9 on page C6-37 for v7 Debug

Table C6-8 Access to Baseline CP14 debug registers in v6 Debug and v6.1 Debug

Debug state	Conditions		Baseline CP14 instructions ^a	DBGDSCRint writes
	Processor mode	DBGDSCR.UDCCdis ^b		
Yes	X	X	Proceed	Proceed
No	User	0	Proceed	UNDEFINED
No	User	1	UNDEFINED	UNDEFINED
No	Privileged	X	Proceed	Proceed

- a. Read DBGDIDR, DBGDSCRint, DBGDTRRXint, or write DBGDTRTXint.
 Attempting to use an MCR instruction to access the DBGDIDR always causes an Undefined Instruction exception.
- b. DCC User mode accesses disable bit, see *Debug Status and Control Register (DBGDSCR)* on page C10-10.

Table C6-9 Access to Baseline CP14 debug registers in v7 Debug

Debug state	Conditions			Baseline CP14 instructions ^a
	Processor mode	DBGDSCR.UDCCdis ^b	OS Lock	
Yes	X	X	0	Proceed
Yes	X	X	1	UNPREDICTABLE ^c
No	User	0	0	Proceed
No	User	0	1	UNPREDICTABLE ^c
No	User	1	X	UNDEFINED ^d
No	Privileged	X	0	Proceed
No	Privileged	X	1	UNPREDICTABLE ^c

- a. Read DBGDIDR, DBGDSAR, DBGDRAR, DBGDSCRint, DBGDTRRXint, or write DBGDTRTXint. Attempting to use an MCR instruction to ~~read~~ DBGDIDR, DBGDSAR, DBGDRAR, or DBGDSCRint is UNPREDICTABLE, except in the case shown by footnote ^d.
- b. DCC user accesses disable bit, see *Debug Status and Control Register (DBGDSCR)* on page C10-10.
- c. ~~Apart from reads of DBGDIDR, which proceed,~~
- d. Under these conditions, attempting to use an MCR instruction to ~~read~~ DBGDIDR, DBGDSAR, DBGDRAR, or DBGDSCRint always causes an Undefined Instruction exception.

Note

The Baseline CP14 instructions are not affected by:

- the recommended Debug Software Enable control in the Debug Access Port, see *Permissions in relation to locks* on page C6-27
- the Sticky Power-down status bit in the Device Power-down and Reset Status Register (DBGPRSR), see *Device Power-down and Reset Status Register (DBGPRSR), v7 Debug only* on page C10-34.

For more information on access permissions and restrictions see *Access permissions* on page C6-26.

In addition:

- if the debug power domain is powered down, instructions that access the debug registers are UNPREDICTABLE
- when the processor is in debug logic reset, reads of the debug registers return UNKNOWN values.

v7 Debug CP14 debug registers access permissions, Extended CP14 interface not implemented

Table C6-10 summarizes the complete set of CP14 instructions if the Extended CP14 interface is not implemented. In this situation, only the Baseline CP14 interface is implemented.

Table C6-10 Access to unallocated CP14 debug registers, v7 Debug with no Extended CP14 interface

Conditions		CP14 debug MCR and MRC instructions, other than Baseline CP14 instructions
Debug state	Processor mode	
Yes	X	UNPREDICTABLE
No	User	UNDEFINED
No	Privileged	UNPREDICTABLE

v7 Debug CP14 debug registers access permissions, Extended CP14 interface implemented

If the Extended CP14 interface is implemented, the Debug Software Enable function can be used to prevent access to registers other than the DBGDIDR, DBGDSCR, DBGDTRRX, DBGDTRTX, DBGDSAR, DBGDRAR, DBGOSLAR, DBGOSLSR and DBGOSSRR. For more information, see *Permissions in relation to locks* on page C6-27.

For a v7 Debug implementation with the Extended CP14 interface:

- Table C6-9 on page C6-37 shows the access permissions for the Baseline CP14 debug registers
- Table C6-11 summarizes the access permissions for the other CP14 debug registers
- Table C6-12 on page C6-40 gives more information about access to the Extended CP14 interface debug registers.

Table C6-11 Access to CP14 debug registers, v7 Debug with Extended CP14 interface

Debug state	Conditions ^a		Other CP14 debug instructions ^b	
	Processor mode	Enable ^c	CRn <= 0b0111 ^d	CRn >= 0b1000
Yes	X	0	UNDEFINED ^e	UNPREDICTABLE
Yes	X	1	See Table C6-12 on page C6-40 ^f	UNPREDICTABLE
No	User	X	UNDEFINED	UNDEFINED
No	Privileged	0	UNDEFINED ^e	UNPREDICTABLE
No	Privileged	1	See Table C6-12 on page C6-40	UNPREDICTABLE

- The accesses in this table are not affected by the value of the DBGDSCR.UDCCdis bit.
- All MRC and MCR instructions with <coproc> == 0b1110 and <opc1> == 0b000 except for read accesses to DBGDIDR, DBGDSAR, DBGDRAR, DBGDSCRint, and DBGDTRRXint, and write accesses to DBGDTRTXint.
- Debug Software Enable function is enabled.
- Where indicated in this column, see Table C6-12 on page C6-40 for a more detailed description of access permissions to the other registers defined by the Debug architecture. In addition, there is more information about access to reserved and IMPLEMENTATION DEFINED registers in *Access to implementation defined and reserved registers* on page C6-29.
- Except for the OS Save and Restore mechanism registers DBGOSLAR, DBGOSLSR, and DBGOSSRR, and the DBGPRSR. The state of the Debug Software Enable function does not affect access to these registers. Access to ~~these registers~~ must always be provided, even on implementations that do not support ~~debug over power-down~~. If the implementation does not support ~~debug over power-down~~ the DBGOSLAR, ~~DBGOSLSR~~, and DBGOSSRR are ~~RAZWI~~.
- ARM deprecates the use of these instructions from User mode in Debug state.

Table C6-12 Access to Extended CP14 interface debug registers

Conditions		Registers:				
Sticky Power-down set	OS Lock set	DBGECR, DBGDRCR, DBGOSLAR ^a , DBGOSLSR ^a , DBGPRCR, DBGPRSR	DBGOSSRR ^a	Other debug ^b	All reserved ^c	Other mgmt ^d
No	No	OK	UNPREDICTABLE	OK	UNPREDICTABLE	OK
No	Yes	OK	OK	UNDEFINED	UNPREDICTABLE	OK
Yes	X	OK	UNPREDICTABLE	UNDEFINED	UNPREDICTABLE	OK

- a. If the OS Save and Restore mechanism is not implemented, ~~these registers addresses behave as reserved locations.~~
- b. Debug register numbers 0 to 127, except for the DBGECR, DBGDRCR, the registers defined as baseline registers, and reserved registers. For details of the baseline registers see Table C6-4 on page C6-32.
- c. See also *Access to implementation defined and reserved registers* on page C6-29.
- d. Other management registers. This means debug register numbers 832 to 1023, except for the IMPLEMENTATION DEFINED locations, see *Access to implementation defined and reserved registers* on page C6-29.

In v7 Debug the behavior of Extended CP14 interface MRC and MCR instructions also depends on the access type of the register, as shown in Table C6-2 on page C6-18. Table C6-13 summarizes the behavior of these instructions, for:

- read accesses, using MRC p14, 0, <Rt>, <CRn>, <CRm>, <opc2>
- write accesses, using MCR p14, 0, <Rt>, <CRn>, <CRm>, <opc2>.

Table C6-13 Behavior of CP14 MRC and MCR instructions, v7 Debug with Extended CP14 interface

Access type ^a	Read access ^b	Write access ^b
- (Reserved)	UNPREDICTABLE	UNPREDICTABLE
Read-only	Returns register value in Rt	UNPREDICTABLE
Write-only	UNPREDICTABLE	Writes value in Rt to register
Read/write	Returns register value in Rt	Writes value in Rt to register

- a. Register access type, as shown in Table C6-2 on page C6-18.
- b. In a privileged mode, or in Debug state.

Some read/write registers include bits that are read-only. These bits ignore writes.

When the processor is in Non-debug state, all User mode accesses to the Extended CP14 interface registers are UNDEFINED.

For example, in privileged modes the following instruction reads the value of DBGWVR7, register 103, if at least 8 watchpoints are implemented, and is UNPREDICTABLE otherwise:

```
MRC p14, 0, <Rt>, c0, c7, 6
```

Note

The access permissions in Table C6-11 on page C6-39 and Table C6-12 on page C6-40 have precedence over the behavior in Table C6-13 on page C6-40. For example, even if at least 8 watchpoints are implemented, the following instruction is UNDEFINED in all processor modes when the Debug Software Enable function is disabled:

```
MRC p14, 0, <Rt>, c0, c7, 6
```

v6 Debug and v6.1 Debug CP14 debug registers access permissions

In v6 Debug and v6.1 Debug, access to registers other than the DBGDIDR, DBGDSCR, DBGDTRRX, and DBGDTRTX is not permitted if Halting debug-mode is selected. The Debug Software Enable function, the Sticky Power-down status bit and the OS Lock are not implemented, and there are fewer CP14 debug registers than in the v7 Debug Extended CP14 interface.

For v6 Debug and v6.1 Debug:

- Table C6-8 on page C6-36 shows the access permissions for the Baseline CP14 debug registers
- Table C6-14 shows the access permissions for the other CP14 debug registers.

Table C6-14 Access to CP14 debug registers, v6 Debug and v6.1 Debug

Debug state	Conditions ^a		Other CP14 debug instructions ^b
	Processor mode	DBGDSCR[15:14] ^c	
Yes	X	XX	Proceed
No	User	XX	UNDEFINED
No	Privileged	00 (None)	UNDEFINED
No	Privileged	X1 (Halting)	UNDEFINED
No	Privileged	10 (Monitor)	Proceed

a. The accesses in this table are not affected by the value of the DBGDSCR.UDCCdis bit.

b. All instructions with <opc1> == 0b000 and <CRn> == 0b0000, except for read accesses to DBGDIDR, DBGDSAR, DBGDRAR, DBGDSCRint, and DBGDTRRXint, and write accesses to DBGDSCRint and DBGDTRTXint. See also Table C6-15 on page C6-42.

c. MDBGen and HDBGen bits, debug-mode enable and select bits.

In v6 Debug and v6.1 Debug the behavior of CP14 MRC and MCR instructions also depends on access type of the register, as shown in Table C6-2 on page C6-18. Table C6-15 summarizes the behavior, for:

- read accesses, using MRC p14, 0, <Rt>, <CRn>, <CRm>, <opc2>
- write accesses, using MCR p14, 0, <Rt>, <CRn>, <CRm>, <opc2>.

Table C6-15 Behavior of CP14 MRC and MCR instructions in v6 Debug and v6.1 Debug

Access type ^a	Read access	Write access
- (Reserved)	UNDEFINED	UNDEFINED
Read-only (DBGDIDR ^b)	Returns register value in Rt	UNDEFINED
Write-only ^c	-	-
Read/write	Returns register value in Rt	Writes value in Rt to register

a. Register access type, as shown in Table C6-2 on page C6-18.

b. The DBGDIDR is the only read-only register in v6 Debug and v6.1 Debug.

c. There are no write-only registers in v6 Debug and v6.1 Debug.

Some read/write registers include bits that are read-only. These bits ignore writes.

For example, the following instruction reads the value of DBGWVR7, register 103, if at least 8 watchpoints are implemented, and is UNDEFINED otherwise:

```
MRC p14, 0, <Rt>, c0, c7, 6
```

Note

The access permissions in Table C6-14 on page C6-41 have precedence over those in Table C6-15. For example, even if at least 8 watchpoints are implemented, the following instruction is UNDEFINED in User mode, and is also UNDEFINED in privileged modes when Halting debug-mode is enabled:

```
MRC p14, 0, <Rt>, c0, c7, 6
```

C6.7 The memory-mapped and recommended external debug interfaces

The external debug interface is IMPLEMENTATION DEFINED in all versions of the ARM Debug architecture. This manual describes only the v7 Debug recommendations for this interface. For details of the external debug interface recommendations for v6 Debug and v6.1 Debug, contact ARM.

The memory-mapped interface to the debug registers is optional in v7 Debug.

The Baseline CP14 interface is sufficient to boot-strap access to the register file, and permits software to distinguish between the Extended CP14 and memory-mapped interfaces.

Both the memory-mapped interface and the recommended external debug interface are defined in terms of an addressable register file mapped onto a region of memory.

This section describes:

- the view of the debug registers from the processor through the memory-mapped interface
- the recommended external debug interface.

If the memory-mapped interface is not implemented, the Extended CP14 interface must be implemented, see *Extended CP14 interface* on page C6-33.

C6.7.1 Register map

The register map occupies 4KB of physical address space. The base address is IMPLEMENTATION DEFINED and must be aligned to a 4KB boundary.

———— Note —————

All memory-mapped debug registers must be mapped to Strongly-ordered or Device memory, see *Synchronization of debug register updates* on page C6-24. In systems with the ARMv7 PMSA this requirement applies even when the MPU is disabled.

Each register is mapped at an offset that is the register number multiplied by 4, the size of a word. For example, DBGWVR7, register 103, is mapped at offset 0x19C (412).

The complete list of registers is defined in *Debug register map* on page C6-18, and is not repeated here.

C6.7.2 Shared interface port for the memory-mapped and external debug interfaces

What components in a system can access the memory-mapped interface is IMPLEMENTATION DEFINED. Typically, the processor itself and other processors in the system can access this interface. An external debugger might be able to access the debug registers through the memory-mapped interface, as well as through the external debug interface.

Because the memory-mapped interface and external debug interface share the same memory map and many of the same properties, both interfaces can be implemented as a single physical interface port to the processor.

If the memory-mapped interface and external debug interface are implemented as a single physical interface port, external debugger accesses must be distinguishable from those of software running on a processor, including the ARM processor itself, in the target system. For example, accesses by an external debugger are not affected by the Software Lock. For the recommended memory-mapped or external debug interface this is achieved using the **PADDRDBG[31]** signal, see *PADDRDBG* on page AppxA-15.

C6.7.3 Endianness

The recommended memory-mapped and external debug interface port, referred to as the debug port, only supports word accesses. The data presented or returned on the interface is always 32 bits and is in a fixed byte order:

- bits [7:0] of the debug register are mapped to bits [7:0] of the connected data bus
- bits [15:8] of the debug register are mapped to bits [15:8] of the connected data bus
- bits [23:16] of the debug register are mapped to bits [23:16] of the connected data bus
- bits [31:24] of the debug register are mapped to bits [31:24] of the connected data bus.

The debug port ignores bits [1:0] of the address. These signals are not present in the debug port interface.

The *Debug Access Port* (DAP) and the interface between it and the debug port together form part of the external debug interface, and must support word accesses from the external debugger to these registers. The recommended ARM Debug Interface v5 (ADIV5) supports word accesses, see the *ARM Debug Interface v5 Architecture Specification* for more information. Where this interface is used the implementation must ensure that a 32-bit access by the debugger through the Debug Access Port has the same 32-bit value, in the same bit order, as the corresponding access to the debug registers. This is a requirement for tools support using ADIV5.

If a memory-mapped interface is implemented, the debug port connects to the system interconnect fabric either directly or through some form of bridge component. Such system interconnect fabrics normally support byte accesses. The system must support word-sized accesses to the debug registers. When accessing the debug registers, the behavior of an access that is smaller than word-sized is UNPREDICTABLE.

The detailed behavior of this bridge and of the system interconnect is outside the scope of the architecture.

Accesses to registers made through the debug port are not affected by the endianness configuration of the processor in which the registers reside. However, they are affected by the endianness configuration of the bus master making the access, and by the nature and configuration of the fabric that connects the two.

In an ARMv7 processor, the CPSR.E bit controls the endianness. With some assumptions, described later in this section, the operation of the CPSR.E bit is:

CPSR.E bit set to 0, for little-endian operation

If the processor reads its own DBGDIDR with an LDR instruction, the system ensures that the value returned in the destination register is in the same bit order as the DBGDIDR itself.

CPSR.E bit set to 1, for big-endian operation

If the processor reads its own DBGDIDR with an LDR instruction, the system ensures that:

- bits [7:0] of DBGDIDR are read into bits [31:24] of the destination register
- bits [15:8] of DBGDIDR are read into bits [23:16] of the destination register

- bits [23:16] of DBGDIDR are read into bits [15:8] of the destination register
- bits [31:24] of DBGDIDR are read into bits [7:0] of the destination register.

Similarly the bytes of a data value written to a debug register, for example the DBGDSCR, are reversed in big-endian configuration.

If an ARMv7 processor, with the E bit set for little-endian operation, reads the DBGDIDR of a second ARMv7 processor with an LDR instruction, then bits [7:0] of the DBGDIDR of the second processor are read into bits [7:0] of the destination register of the LDR, on the first processor. Similarly, the other bytes of the DBGDIDR are copied to the corresponding bytes of the destination register. However, if the E bit of the first processor is set for big-endian operation the bytes are reversed during the LDR operation, with bits [31:24] of the DBGDIDR of the second processor being read to bits [7:0] of the destination register of the LDR.

Note

The ordering of the bytes in the destination register on the first processor is not affected in any way by the setting of the CPSR.E bit of the second processor.

These examples assume that no additional manipulation of the data occurs in the interconnect fabric of the system. For example, an interconnect might perform byte transposition for accesses made across a boundary between a little-endian subsystem and a big-endian subsystem. Such transformations are beyond the scope of the architecture.

C6.7.4 Permission summaries for memory-mapped and external debug interfaces

This section gives summaries of the permission controls and their effects for different implementations of v7 Debug systems. The following subsections describe the access permissions for the two interfaces:

- *Access permissions for the external debug interface* on page C6-47
- *Access permissions for the memory-mapped interface* on page C6-48.

Note

For more information about access permissions in an implementation that includes the OS Save and Restore mechanism but does not provide access to the DBGOSSRR through the external debug interface, see the Note in *The OS Save and Restore mechanism* on page C6-8.

The remaining subsections apply to both interfaces:

- *Meanings of terms and abbreviations used in this section* on page C6-46
- *Permissions summary for separate debug and core power domains* on page C6-48
- *Permissions summary for SinglePower (debug and core in single power domain)* on page C6-50.

Meanings of terms and abbreviations used in this section

The following terms and abbreviations are used in the tables that summarize the access permissions:

X	Don't care. The outcome does not depend on this condition.
0	The condition is false.
1	The condition is true. For more information, see Table C6-16.
IG/ABT	The access is ignored or aborted.

————— **Note** —————

The IG/ABT response might be implemented outside the processor, for example, by the system or DAP.

Proceed	The access must not be ignored, but the processor or system might return an error response. For more information about the response returned, see: <ul style="list-style-type: none"> • <i>Permissions summary for separate debug and core power domains</i> on page C6-48 • <i>Permissions summary for SinglePower (debug and core in single power domain)</i> on page C6-50.
Not possible	When the debug logic is powered down, accessing the debug registers is not possible. The system must respond to the access, and the response is IMPLEMENTATION DEFINED. ARM recommends that the system returns an error response.
Error	Error response. Writes are ignored and reads return an UNKNOWN value.
OK	Read or write access succeeds. Writes to read-only locations are ignored. Reads from RAZ or write-only locations return zero. Some read/write registers include bits that are read-only. Unless otherwise stated in the bit description, these bits ignore writes.
UNP	The access has UNPREDICTABLE results. Reads return UNKNOWN value.
DBGLAR	Lock Access Register, see <i>Lock Access Register (DBGLAR)</i> on page C10-94. This is one of the management registers.

Table C6-16 lists the control conditions used in this section, and tells you where you can find more information about each of these controls. These conditions can be given an argument of X, 0 or 1, as defined at the start of this section. The table gives more information about the meaning when the argument is 1 for each condition.

Table C6-16 Meaning of (Argument = 1) for the control condition

Control condition	Meaning of (Argument = 1)	For details see
Debug logic powered	The debug power domain is powered up ^a	<i>Permissions in relation to power-down</i> on page C6-28
Core logic powered	The core power domain is powered up ^a	
Processor powered	The single power domain is powered up ^a	
Sticky power-down	DBGPRSR[1] = 1	

Table C6-16 Meaning of (Argument = 1) for the control condition (continued)

Control condition	Meaning of (Argument = 1)	For details see
OS Lock	DBGOSLSR[1] = 1	<i>Permissions in relation to locks on page C6-27</i>
Software Lock	DBGLSR[1] = 1	
Debug Software Enable	The recommended function of the DAP is enabled	

- a. On a SinglePower system, the Processor powered control condition is equivalent to having both Debug logic powered and Core logic powered on a system with the recommended separate debug and core power domains.

Access permissions for the external debug interface

Table C6-17 summarizes the access permissions for the external debug interface.

When the debug logic is not powered, external debug accesses must be prohibited. An implementation can either ignore or abort these accesses.

Table C6-17 Register access permissions for the external debug interface^a

Debug logic powered? ^b	Response	Writes or has other side-effects?
No	Not possible	-
Yes	Proceed	Yes

a. See *Meanings of terms and abbreviations used in this section* on page C6-46 when using this table.

b. Or Processor powered, on a SinglePower system.

Access permissions for the memory-mapped interface

Table C6-17 on page C6-47 summarizes the access permissions for the memory-mapped interface.

At the system level, certain memory-mapped accesses must be prohibited. An implementation can either ignore or abort these accesses.

Table C6-18 Register access permissions for the memory-mapped interface^a

Conditions:				Response	Writes or has other side-effects?
Debug logic powered? ^b	Debug Software Enable	Access privilege	Software Lock		
No	X	X	X	Not possible	-
Yes	0	X	X	IG/ABT	-
Yes	X	User	X	IG/ABT	-
Yes	1	Privileged	0	Proceed	Yes
Yes	1	Privileged	1	Proceed	DBGLAR only ^c

- See *Meanings of terms and abbreviations used in this section* on page C6-46 when using this table.
- Or Processor powered, on a SinglePower system.
- Writes are ignored and reads, such as reads of DBGDSCRExt, have no side-effects. Writes to the DBGLAR are permitted.

Note

If an implementation permits an external debugger to access the memory-mapped interface, it is IMPLEMENTATION DEFINED whether those accesses are controlled by the Debug Software Enable control in the debug access port.

Permissions summary for separate debug and core power domains

For implementations with separate debug and core power domains, the following tables show the effects of permissions on access to memory-mapped debug registers:

- Table C6-19 on page C6-49 for access to debug and management registers
- Table C6-20 on page C6-49 for access to the OS Save and Restore and Power-down registers.

For more information about the conditions that control access to these registers, see Table C6-16 on page C6-46.

Table C6-19 Debug and management register access for separate debug and core power domains^a

Conditions			Registers:			
Core logic powered?	Sticky power-down	OS Lock	DBGDIDR, DBGECR, DBGDRCR	Other debug ^{b, d}	Management ^{c, d}	Reserved ^d
No	X	X	OK	Error	OK	UNP
Yes	0	0	OK	OK	OK	OK
Yes	0	1	OK	Error	OK	UNP
Yes	1	X	OK	Error	OK	UNP

- a. See *Meanings of terms and abbreviations used in this section* on page C6-46 when using this table.
- b. Registers in the memory region 0x000 - 0x1FC, except for the DBGDIDR, DBGECR, and DBGDRCR, and reserved locations.
- c. Registers in the memory region 0xD00 - 0xFFC, except for IMPLEMENTATION DEFINED registers.
- d. For details of the behavior of accesses to reserved and IMPLEMENTATION DEFINED registers see *Access to implementation defined and reserved registers* on page C6-29.

Table C6-20 OS Save and Restore and Power-down register access for separate debug and core power domains^a

Conditions			Registers:		
Core logic powered?	Sticky power-down	OS Lock	DBGOSLSR ^b DBGPRCR, DBGPRSR	DBGOSLAR ^b	DBGOSRR ^b
No	X	X	OK	UNP	UNP
Yes	0	0	OK	OK	UNP
Yes	0	1	OK	OK	OK
Yes	1	X	OK	OK	UNP

- a. See *Meanings of terms and abbreviations used in this section* on page C6-46 when using this table.
- b. If the OS Save and Restore mechanism is not implemented, ~~these registers behave as reserved locations.~~ For details of the behavior of accesses to reserved and IMPLEMENTATION DEFINED registers see *Access to implementation defined and reserved registers* on page C6-29.

Permissions summary for SinglePower (debug and core in single power domain)

For implementations with a single debug and core power domain, when the processor is powered down the system response is IMPLEMENTATION DEFINED. ARM recommends that the system returns an error response, but the processor cannot generate any response. The Sticky Power-down status bit is RAZ.

Table C6-21 and Table C6-22 show the effects of permissions on access to memory-mapped debug registers.

For more information about the conditions that control access to these registers, see Table C6-16 on page C6-46.

Table C6-21 Register accesses for single debug and core power domain, part 1^a

Conditions		Registers:		
Processor powered?	OS Lock	DBGDIDR, DBGECR, DBGDRCR, DBGOSLSR ^b , DBGPRCR, DBGPRSR	DBGOSLAR ^b	DBGOSSRR ^b
No	X	Not possible	Not possible	Not possible
Yes	0	OK	OK	UNP
Yes	1	OK	OK	OK

a. See *Meanings of terms and abbreviations used in this section* on page C6-46 when using this table.

b. If the OS Save and Restore mechanism is not implemented, ~~these registers behave as reserved locations.~~

Table C6-22 Register accesses for single debug and core power domain, part 2^a

Conditions		Registers:		
Processor powered?	OS Lock	Other debug ^{b, d}	Management ^{c, d}	Reserved ^d
No	X	Not possible	Not possible	Not possible
Yes	0	OK	OK	OK
Yes	1	Error	OK	UNP

a. See *Meanings of terms and abbreviations used in this section* on page C6-46 when using this table.

b. Registers in the memory region 0x000 - 0x1FC, except for the DBGDIDR, DBGECR, and DBGDRCR, and reserved locations.

c. Management registers, that is, registers in the memory region 0x000 - 0xFFC, except for IMPLEMENTATION DEFINED registers.

d. For details of the behavior of accesses to reserved and IMPLEMENTATION DEFINED registers see *Access to implementation defined and reserved registers* on page C6-29.

C6.7.5 Registers not implemented in the memory-mapped or external debug interface

In any Debug architecture version, the following registers are not implemented through the memory-mapped or external debug interfaces:

DBGDRAR *Debug ROM Address Register (DBGDRAR)* on page C10-7

DBGDSAR *Debug Self Address Offset Register (DBGDSAR)* on page C10-8.

These registers are not required by an external debugger.

In addition, there is no interface to access to DBGDSCRint, DBGDTRRXint or DBGDTRTXint through the memory-mapped or external debug interface. These operations are only available through the Baseline CP14 interface.

Chapter C7

Non-invasive Debug Authentication

This chapter describes the authentication controls on non-invasive debug operations. It contains the following sections:

- *About non-invasive debug authentication* on page C7-2
- *v7 Debug non-invasive debug authentication* on page C7-4
- *Effects of non-invasive debug authentication* on page C7-6
- *ARMv6 non-invasive debug authentication* on page C7-8.

Note

The recommended external debug interface provides an authentication interface that controls both invasive debug and non-invasive debug, as described in *Authentication signals* on page AppxA-3. This chapter describes how you can use this interface to control non-invasive debug. For information about using the interface to control invasive debug see Chapter C2 *Invasive Debug Authentication*.

C7.1 About non-invasive debug authentication

Non-invasive debug can be enabled or disabled through the external debug interface. In addition, if a processor implements the Security Extensions, non-invasive debug operations can be permitted or not permitted.

The difference between enabled and permitted is that the permitted non-invasive debug operations depend on both the security state and the operating mode of the processor. The alternatives for when non-invasive debug is permitted are:

- in all processor modes, in both Secure and Non-secure security states
- only in Non-secure state
- in Non-secure state and in Secure User mode.

Whether non-invasive debug operations are permitted in Secure User mode depends on the value of the `SDER.SUNIDEN` bit, see *c1, Secure Debug Enable Register (SDER)* on page B3-108.

In v6.1 Debug and v7 Debug, non-invasive debug authentication can be controlled dynamically, meaning that whether non-invasive debug is permitted can change while the processor is running, or while the processor is in Debug state. However, for more information, see *Generation of debug events* on page C3-40.

In v6 Debug, non-invasive debug authentication can be changed only while the processor is in reset.

In the recommended external debug interface, the signals that control the enabling and permitting of non-invasive debug are **DBGEN**, **SPIDEN**, **NIDEN** and **SPNIDEN**, see *Authentication signals* on page AppxA-3.

Part C of this manual assumes that the recommended external debug interface is implemented.

SPIDEN and **SPNIDEN** are only implemented on processors that implement Security Extensions. **NIDEN** is an optional signal in v6 Debug and v6.1 Debug.

————— Note —————

- **DBGEN** and **SPIDEN** also control invasive debug, see *About invasive debug authentication* on page C2-2.
- In v6 Debug and v6.1 Debug, **NIDEN** might be implemented on some non-invasive debug components and not on others. For example, the performance monitoring unit for a processor might implement **NIDEN** when the trace macrocell for the same processor does not.
- For more information about use of the authentication signals see *Changing the authentication signals* on page AppxA-4.
- For more information about ARMv6 non-invasive debug see *ARMv6 non-invasive debug authentication* on page C7-8.

If both **DBGEN** and **NIDEN** are LOW, no non-invasive debug is permitted.

Non-invasive debug authentication in v7 Debug is described in the section *v7 Debug non-invasive debug authentication* on page C7-4.

The behavior of the non-invasive debug components when non-invasive debug is not enabled or not permitted is described in the following sections. These sections also describe the behavior when the processor is in Debug state:

- *Performance monitors* on page C7-6
- *Trace* on page C7-7
- *Reads of the Program Counter sampling registers* on page C8-3.

ARMv6 non-invasive debug authentication on page C7-8 describes the architectural requirements for an v6 Debug or v6.1 Debug implementation.

Note

Invasive and non-invasive debug authentication enable you to protect Secure processing from direct observation or invasion by a debugger that you do not trust. If you are designing a system you must be aware that security attacks can be aided by the invasive and non-invasive debug facilities. For example, Debug state or the DBGDSCR.INTdis bit might be used for a denial of service attack, and the Non-secure performance monitors might be used to measure the side-effects of Secure processing on Non-secure code. ARM recommends that where you are concerned about such attacks you disable invasive and non-invasive debug in all modes. However you must be aware of the limitations on the protection that debug authentication can provide, because similar attacks can be made by running malicious code on the processor in Non-secure state.

C7.2 v7 Debug non-invasive debug authentication

On processors that do not implement Security Extensions, if **NIDEN** is asserted HIGH, non-invasive debug is enabled and permitted in all modes.

If **DBGEN** is asserted HIGH the system behaves as if **NIDEN** is asserted HIGH, regardless of the actual state of the **NIDEN** signal.

Table C7-1 shows the required behavior in v7 Debug when the Security Extensions are not implemented.

Table C7-1 v7 Debug non-invasive debug authentication, Security Extensions not implemented

DBGEN	NIDEN	Modes in which non-invasive debug is permitted
LOW	LOW	None. Non-invasive debug is disabled.
x	HIGH	All modes.
HIGH	LOW	All modes.

On a processor that implements the Security Extensions:

- If both **NIDEN** and **SPNIDEN** are asserted HIGH, non-invasive debug is enabled and permitted in all modes and security states.
- If **NIDEN** is HIGH and **SPNIDEN** is LOW:
 - non-invasive debug is enabled and permitted in Non-secure state
 - non-invasive debug is not permitted in Secure privileged modes
 - whether non-invasive debug is permitted in Secure User mode depends on the value of the **SDER.SUNIDEN** bit.

If **DBGEN** is HIGH, the system behaves as if **NIDEN** is HIGH, regardless of the actual state of the **NIDEN** signal

If **SPIDEN** is HIGH, the system behaves as if **SPNIDEN** is HIGH, regardless of the actual state of the **SPNIDEN** signal.

Table C7-2 shows the non-invasive debug authentication for ARMv7 processors that implement the Security Extensions.

Table C7-2 v7 Debug non-invasive debug authentication, Security Extensions implemented

DBGEN	Signals				SDER. SUIDEN	Modes in which non-invasive debug is permitted
	NIDEN	SPIDEN	SPNIDEN			
LOW	LOW	x	x	x		None. Non-invasive debug is disabled.
LOW	HIGH	LOW	LOW	0		All modes in Non-secure state
LOW	HIGH	LOW	LOW	1		All modes in Non-secure state, Secure User mode.
LOW	HIGH	LOW	HIGH	x		All modes in both security states.
LOW	HIGH	HIGH	x	x		All modes in both security states.
HIGH	x	LOW	LOW	0		All modes in Non-secure state.
HIGH	x	LOW	LOW	1		All modes in Non-secure state, Secure User mode.
HIGH	x	LOW	HIGH	x		All modes in both security states.
HIGH	x	HIGH	x	x		All modes in both security states.

———— **Note** —————

The value of the SDER.SUIDEN bit does not have any effect on non-invasive debug.

C7.3 Effects of non-invasive debug authentication

The following sections describe the effects of the non-invasive debug authentication on the non-invasive debug components:

- *Performance monitors*
- *Trace* on page C7-7
- *Reads of the Program Counter sampling registers* on page C8-3.

C7.3.1 Performance monitors

Performance monitors provide a non-invasive debug feature, and are controlled by the non-invasive debug authentication signals. For more information, see Chapter C9 *Performance Monitors*.

The cycle counter, PMCCNTR, is not controlled by the non-invasive debug authentication signals. However, setting the PMCR.DP flag to 1 disables PMCCNTR counting in regions of code where the event counters are disabled. For details see *c9, Performance Monitor Control Register (PMCR)* on page C10-105.

Table C7-3 describes the behavior of the performance monitors when non-invasive debug is disabled or not permitted, and in Debug state.

Table C7-3 Behavior of performance monitors when non-invasive debug not permitted

Debug state	Non-invasive debug permitted and enabled	PMCR.DP ^a	Event counters enabled and events exported ^{a, b}	PMCCNTR enabled
Yes	x	x	No	No
No	Yes	x	Yes	Yes
No	No	0	No	Yes
No	No	1	No	No

a. See *c9, Performance Monitor Control Register (PMCR)* on page C10-105.

b. The events are exported only if the PMCR.X bit is set to 1.

The performance monitors are not intended to be completely accurate, see *Accuracy of the performance monitors* on page C9-5. In particular, some inaccuracy is permitted at the point of changing security state. However, to avoid the leaking of information from the Secure state, the permitted inaccuracy is that non-prohibited transactions can be uncounted. Prohibited transactions must not be counted.

Entry to and exit from Debug state can also disturb the normal running of the processor, causing additional inaccuracy in the performance monitors. Disabling the counters while in Debug state limits the extent of this inaccuracy. Implementations can limit this inaccuracy to a greater extent, for example by disabling the counters as soon as possible during the Debug state entry sequence.

C7.3.2 Trace

All instructions and data transfers are ignored by the trace device when:

- non-invasive debug is disabled
- the processor is in a mode or state where non-invasive debug is not permitted
- the processor is in Debug state.

C7.4 ARMv6 non-invasive debug authentication

An ARMv6 processor might implement the v7 Debug non-invasive debug authentication signaling described in *v7 Debug non-invasive debug authentication* on page C7-4.

In general, non-invasive debug authentication in ARMv6 Debug is IMPLEMENTATION DEFINED. For details of the implemented authentication scheme you must see the appropriate product documentation. In particular:

- it is IMPLEMENTATION DEFINED whether the **NIDEN** signal is implemented
- the exact roles of the following signals are IMPLEMENTATION DEFINED:
 - **DBGEN**, **SPIDEN**, and **SPNIDEN**
 - **NIDEN**, if it is implemented.

However, an ARMv6 non-invasive debug authentication scheme must obey the following rules:

- If **NIDEN** is implemented then tying **NIDEN** and **DBGEN** both LOW guarantees that non-invasive debug is disabled.
- if **NIDEN** is not implemented then the mechanism for disabling non-invasive debug is IMPLEMENTATION DEFINED. An implementation might not support any mechanism for disabling non-invasive debug.
- When the Security Extensions are implemented, tying **SPIDEN** and **SPNIDEN** both LOW guarantees that non-invasive debug is not permitted in Secure privileged modes.

In addition, if **SPIDEN** and **SPNIDEN** are both LOW then setting **SDER.SUNIDEN** to 0 guarantees that non-invasive debug is not permitted in Secure User mode.

If non-invasive debug is enabled then if **SDER.SUNIDEN** is 1, non-invasive debug is permitted in Secure User mode.

- If **NIDEN** is implemented then tying **NIDEN** and **SPNIDEN** both HIGH is guaranteed to enable and permit non-invasive debug in all modes in both security states.
If **NIDEN** is not implemented then tying **SPNIDEN** HIGH is guaranteed to enable and permit non-invasive debug in all modes in both security states.

Table C7-4 shows the architectural requirements for non-invasive debug behavior in an ARMv6 Debug implementation that does not include the Security Extensions.

Table C7-4 ARMv6 non-invasive debug authentication requirements, Security Extensions not implemented

NIDEN	DBGEN	Non-invasive debug behavior
Implemented and LOW	LOW	Disabled.
Implemented and HIGH	x	Enabled.

Table C7-5 shows the architectural requirements for non-invasive debug behavior in an ARMv6 Debug implementation that includes the Security Extensions.

Table C7-5 ARMv6 non-invasive debug authentication requirements, Security Extensions implemented

NIDEN	Signals			SDER. SUNIDEN	Non-invasive debug behavior
	DBGEN	SPIDEN	SPNIDEN		
Implemented and LOW	LOW	x	x	x	Disabled.
x	x	LOW	LOW	0	Not permitted in all modes in Secure state.
x	x	LOW	LOW	1	Not permitted in Secure privileged modes. Permitted in Secure User mode if enabled.
Implemented and HIGH	x	x	x	x	Permitted in all modes in Non-secure state. Might also be permitted in Secure state.
Implemented and HIGH	x	x	HIGH	x	Permitted in all modes and security states.
Not implemented	x	x	HIGH	x	Permitted in all modes and security states.

An ARMv6 Debug implementation that includes the Security Extensions might have other signal combinations that permit non-invasive debug in Secure privileged modes. You must take care to avoid unknowingly permitting non-invasive debug.

There is no mechanism that a debugger can use to determine the implemented mechanism for controlling non-invasive debug on an ARMv6 processor. You must see the product documentation for this information.

Chapter C8

Sample-based Profiling

This chapter describes sample-based profiling. Sample-based profiling is an optional non-invasive debug component. It contains the following section:

- *Program Counter sampling* on page C8-2.

C8.1 Program Counter sampling

In ARMv6, the *Program Counter Sampling Register (DBGPCSR)* is an optional part of the recommended external debug interface. It is not defined by the architecture.

In v7 Debug, Program Counter sampling is an optional feature defined by the architecture. The following sections describe this feature:

- *Implemented Program Counter sampling registers*
- *Reads of the Program Counter sampling registers* on page C8-3

C8.1.1 Implemented Program Counter sampling registers

In v7 Debug, it is IMPLEMENTATION DEFINED whether the DBGPCSR is implemented. It is an optional extension to the Debug architecture, that provides a mechanism for coarse-grained profiling of code executing on the processor without changing the behavior of that code. For details see *Program Counter Sampling Register (DBGPCSR)* on page C10-38.

If the DBGPCSR is implemented, it is IMPLEMENTATION DEFINED whether a second sampling register is also implemented. This register is the Context ID Sampling Register (DBGCIDS) and is described in *Context ID Sampling Register (DBGCIDS)* on page C10-39.

If a processor does not implement DBGPCSR it does not implement DBGCIDS.

If a processor implements only DBGPCSR, it is IMPLEMENTATION DEFINED whether it is implemented as register 33, as register 40, or as both register 33 and register 40.

If a processor implements both DBGPCSR and DBGCIDS:

- it must implement:
 - DBGPCSR as register 40
 - DBGCIDS as register 41
- it is IMPLEMENTATION DEFINED whether it also implements DBGPCSR as register 33.

If a processor implements DBGPCSR as both register 33 and register 40, the two register numbers are aliases of a single register. ARM deprecates reading DBGPCSR as register 33 on an implementation that also implements it as register 40.

To determine which, if any, of the Program Counter sampling registers are implemented, and the register numbers used for any implemented registers, read:

- the DEVID_imp and PCSR_imp bits of the DBGDIDR, see *Debug ID Register (DBGDIDR)* on page C10-3
- the DBGDEVID.PCsampl field, see *Debug Device ID Register (DBGDEVID)* on page C10-6.

Note

ARM recommends that an implementation that supports sample-based profiling:

- implements both DBGPCSR and DBGCIDSR
 - implements DBGPCSR as register 40
 - also implements DBGPCSR as register 33, for backwards compatibility with implementations that implement it only as register 33.
-

C8.1.2 Reads of the Program Counter sampling registers

A read of the DBGPCSR:

- Normally:
 - returns the address of an instruction *recently executed* by the processor
 - sets the DBGCIDSR, if implemented, to the current value of the CONTEXTIDR.

For more information about the CONTEXTIDR, see:

 - *c13, Context ID Register (CONTEXTIDR)* on page B3-153, for a VMSA implementation
 - *c13, Context ID Register (CONTEXTIDR)* on page B4-76, for a PMSA implementation.
- Alternatively, when any of the following is true, returns 0xFFFFFFFF and sets the DBGCIDSR, if implemented, to an UNKNOWN value:
 - non-invasive debug is disabled
 - the processor is in a mode or state where non-invasive debug is not permitted
 - the processor is in Debug state.

If the DBGCIDSR is implemented, reading it returns the last value to which it was set.

Note

The ARM architecture does not define *recently executed*. The delay between an instruction being executed by the processor and its address appearing in the DBGPCSR is not defined. For example, if a piece of code reads the DBGPCSR of the processor it is running on, there is no guaranteed relationship between the program counter for that piece of code and the value read. The DBGPCSR is intended only for use by an external agent to provide statistical information for code profiling.

The value in the DBGPCSR always references a committed instruction. An implementation must not sample values that reference instructions that are fetched but not committed for execution.

If DBGPCSR is implemented, it must be possible to sample references to branch targets. It is IMPLEMENTATION DEFINED whether references to other instructions can be sampled. ARM recommends that a reference to any instruction can be sampled.

The branch target for a conditional branch instruction that fails its condition code check is the instruction that follows the conditional branch instruction. The branch target for an exception is the exception vector address.

If an instruction writes to the CONTEXTIDR, it is UNPREDICTABLE whether the DBGCIDSR is set to the original or new value of CONTEXTIDR when a read of the DBGPCSR samples a subsequent instruction that occurs before the earliest of:

- the execution of an ISB instruction or an ISB operation
- the taking of an exception
- the execution of an exception return instruction.

Chapter C9

Performance Monitors

This chapter describes the performance monitors, that are a non-invasive debug component. It contains the following sections:

- *About the performance monitors* on page C9-2
- *Status in the ARM architecture* on page C9-4
- *Accuracy of the performance monitors* on page C9-5
- *Behavior on overflow* on page C9-6
- *Interaction with Security Extensions* on page C9-7
- *Interaction with trace* on page C9-8
- *Interaction with power saving operations* on page C9-9
- *CP15 c9 register map* on page C9-10
- *Access permissions* on page C9-12
- *Event numbers* on page C9-13.

C9.1 About the performance monitors

The basic organization of the performance monitors is:

- A cycle counter. This can be programmed to increment either on every cycle, or once every 64 cycles.
- A number of event counters. Each counter is configured to select the event that increments the counter. Space is provided in the architecture for up to 31 counters. The actual number of counters is IMPLEMENTATION DEFINED, and there is an identification mechanism for the counters.
- Controls for enabling the counters, resetting the counters, flagging overflows, and enabling interrupts on counter overflow.

The cycle counter can be enabled independently of the event counters.

The counters are held in a set of registers that can be accessed in coprocessor space. This means the counters can be accessed from the operating system running on the processor, enabling a number of uses, including:

- dynamic compilation techniques
- energy management.

In addition, you can provide access to the counters from application code, if required. This enables applications to monitor their own performance with fine grain control without requiring operating system support. For example, an application might implement per-function performance monitoring.

There are many situations where performance monitoring features integrated into the processor are valuable for applications and for application development. When an operating system does not use the performance monitors itself, ARM recommends that it enables application code access to the performance monitors. However an implementation can choose not to implement any performance monitors.

To enable interaction with external monitoring, an implementation might consider additional enhancements, including:

- Providing a set of events, from which a selection can be exported onto a bus for use as external events. For very high frequency operation, this might introduce unacceptable timing requirements, but the bus could be interfaced to the trace macrocell or another closely coupled resource.
- Providing the ability to count external events. Here, again, there are clock frequency issues between the processor and the system. A suitable approach might be to edge-detect changes in the signals and to use those changes to increment a counter.

This enhancement requires the processor to implement a set of external event input pins.

- Providing memory-mapped and external debug access to the performance monitor registers, to enable the counter resources to be used for system monitoring in systems where they are not used by the software running on the processor.

Such access is not described in this manual. Contact ARM if you require more information about this option.

The set of events that might be monitored splits into:

- events that are likely to be consistent across many microarchitectures
- implementation specific events.

Therefore, this architecture defines a common set of events to be used across many microarchitectures, and a large space reserved for IMPLEMENTATION DEFINED events.

The full set of events for any given implementation is IMPLEMENTATION DEFINED, and there is no requirement to implement any of the common set of events. ARM recommends that ARMv7 processors implement as many of the events as are feasible given the architecture profile and microarchitecture of the implementation.

The event numbers of the common set of events are reserved for the specified events. In this set, a particular event number must either:

- be used for its assigned event
- not be used.

When an ARMv7 processor supports monitoring of an event that is assigned a number in the range allocated to the common set of events range, if possible it must use that number for the event. However, ARM might introduce additional event definitions in this range in future editions of this manual. Therefore software might encounter implementations where an event assigned a number in this range is monitored using an event number from the IMPLEMENTATION DEFINED range.

C9.2 Status in the ARM architecture

The status of the architecturally-defined performance monitors block is that it is an IMPLEMENTATION DEFINED space for ARMv7, but ARM recommends implementers to use the approach described here to implement the performance monitors.

C9.3 Accuracy of the performance monitors

The performance monitors provide approximately accurate performance count information. To keep the implementation and validation cost low, a reasonable degree of inaccuracy in the counts is acceptable. There is no exact definition of *reasonable degree of inaccuracy*, but ARM recommends the following guidelines:

- Under normal operating conditions, the counters must present an accurate value of the count.
- In exceptional circumstances, such as changes in security state or other boundary conditions, it is acceptable for the count to be inaccurate.
- Under very unusual non-repeating pathological cases counts can be inaccurate. These cases are likely to occur as a result of asynchronous exceptions, such as interrupts, where the chance of a systematic error in the count is vanishingly unlikely.

———— **Note** ————

An implementation must not introduce inaccuracies that can be triggered systematically by normal pieces of code that are running. For example, dropping a branch count in a loop due to the structure of the loop gives a systematic error that makes the count of branch behavior very inaccurate, and this is not reasonable. However, the dropping of a single branch count as the result of a rare interaction with an interrupt is acceptable.

The permitted inaccuracy limits the possible uses of the performance monitors. In particular, the point in a pipeline where the event counter is incremented is not defined relative to the point where a read of the event counters is made. This means that pipelining effects can cause some imprecision. An implementation must document any particular scenarios where significant inaccuracies are expected.

C9.4 Behavior on overflow

On counter overflow:

- An overflow status flag is set to 1. See *c9, Overflow Flag Status Register (PMOVSr)* on page C10-110.
- An interrupt request is generated if the processor is configured to generate counter overflow interrupts. For details see *c9, Interrupt Enable Set Register (PMINTENSET)* on page C10-118 and *c9, Interrupt Enable Clear Register (PMINTENCLR)* on page C10-119.
- The counter wraps to zero and continues counting events. Counting continues as long as the counters are enabled, regardless of any overflows.

The counter always resets to zero and overflows after 32 bits of increment. To enable a more frequent generation of interrupt requests, the counters can be written to. For example, an interrupt handler might reset the overflowed counter to `0xFFFF0000` to generate another overflow interrupt after 16 bits of increment.

———— **Note** ————

The mechanism by which an interrupt request from the performance monitors generates an FIQ or IRQ exception is IMPLEMENTATION DEFINED.

—————

The interrupt handler for the counter interrupt must cancel the interrupt by clearing the overflow flag.

C9.5 Interaction with Security Extensions

The performance monitors provide a non-invasive debug feature, and therefore are controlled by the non-invasive debug authentication signals. *About non-invasive debug authentication* on page C7-2 describes how non-invasive debug interacts with Security Extensions.

Performance monitors on page C7-6 describes the behavior of the performance monitors when:

- non-invasive debug is disabled
- the processor is in a mode or state where non-invasive debug is not permitted
- the processor is in Debug state.

Note

Additional controls in the PMCR can also disable the event counters and the PMCCNTR. Disabling the event counters and the PMCCNTR in the PMCR takes precedence over the authentication controls.

The performance monitor registers are Common registers, see *Common CP15 registers* on page B3-74. They are always accessible regardless of the values of the authentication signals and SUNIDEN. Authentication controls whether the counters count events, not to control access to the performance monitor registers.

C9.6 Interaction with trace

It is IMPLEMENTATION DEFINED whether counter events are exported to a trace macrocell or other external monitoring agents to provide triggering information. The form of the exporting is also IMPLEMENTATION DEFINED. If implemented, this exporting might be enabled as part of the performance monitoring control functionality.

Similarly, ARM recommends system designers to include a mechanism for importing a set of external events to be counted, but such a feature is IMPLEMENTATION DEFINED. When implemented, this feature enables the trace module to pass in events to be counted.

C9.7 Interaction with power saving operations

All counters are subject to any changes in clock frequency, including clock stopping caused by the WFI and WFE instructions.

C9.8 CP15 c9 register map

The performance monitor registers are mapped into part of the CP15 register map. The registers are described in *Performance monitor registers* on page C10-105.

Figure C9-1 shows the CP15 c9 encodings for the recommended performance monitor registers, and the reserved encodings for IMPLEMENTATION DEFINED performance monitors:

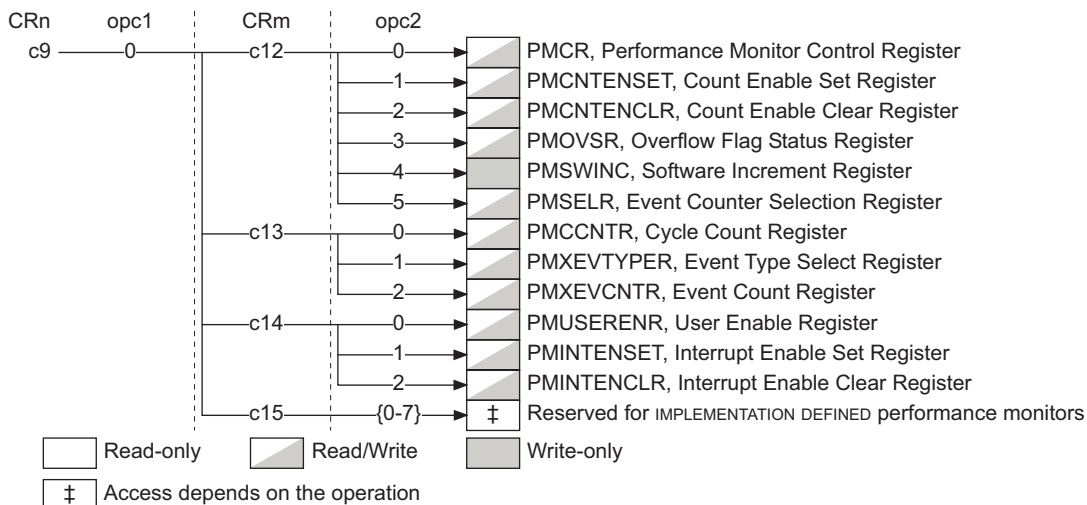

Figure C9-1 Recommended CP15 performance monitor registers

Table C9-1 lists the instructions used to access the recommended performance monitor registers.

Table C9-1 Recommended performance monitor registers

Instruction ^a	Description or notes
MRC p15,0,<Rt>,c9,c12,0 MCR p15,0,<Rt>,c9,c12,0	c9, <i>Performance Monitor Control Register (PMCR)</i> on page C10-105.
MRC p15,0,<Rt>,c9,c12,1 MCR p15,0,<Rt>,c9,c12,1	c9, <i>Count Enable Set Register (PMCNTENSET)</i> on page C10-108.
MRC p15,0,<Rt>,c9,c12,2 MCR p15,0,<Rt>,c9,c12,2	c9, <i>Count Enable Clear Register (PMCNTENCLR)</i> on page C10-109.
MRC p15,0,<Rt>,c9,c12,3 MCR p15,0,<Rt>,c9,c12,3	c9, <i>Overflow Flag Status Register (PMOVSr)</i> on page C10-110.

Table C9-1 Recommended performance monitor registers (continued)

Instruction ^a	Description or notes
MRC p15,0,<Rt>,c9,c12,4	UNPREDICTABLE. PMSWINC is a write-only register.
MCR p15,0,<Rt>,c9,c12,4	c9, <i>Software Increment Register (PMSWINC)</i> on page C10-112.
MRC p15,0,<Rt>,c9,c12,5 MCR p15,0,<Rt>,c9,c12,5	c9, <i>Event Counter Selection Register (PMSELR)</i> on page C10-113.
MRC p15,0,<Rt>,c9,c13,0 MCR p15,0,<Rt>,c9,c13,0	c9, <i>Cycle Count Register (PMCCNTR)</i> on page C10-114.
MRC p15,0,<Rt>,c9,c13,1 MCR p15,0,<Rt>,c9,c13,1	c9, <i>Event Type Select Register (PMXEVTYPER)</i> on page C10-115.
MRC p15,0,<Rt>,c9,c13,2 MCR p15,0,<Rt>,c9,c13,2	c9, <i>Event Count Register (PMXEVCNTR)</i> on page C10-116.
MRC p15,0,<Rt>,c9,c14,0 MCR p15,0,<Rt>,c9,c14,0	c9, <i>User Enable Register (PMUSERENR)</i> on page C10-117.
MRC p15,0,<Rt>,c9,c14,1 MCR p15,0,<Rt>,c9,c14,1	c9, <i>Interrupt Enable Set Register (PMINTENSET)</i> on page C10-118.
MRC p15,0,<Rt>,c9,c14,2 MCR p15,0,<Rt>,c9,c14,2	c9, <i>Interrupt Enable Clear Register (PMINTENCLR)</i> on page C10-119.

a. CP15 c9 encodings with CRm == {c12-c14} not listed in the table are reserved. For details of the behavior of accesses to these encodings see *Unallocated CP15 encodings* on page B3-69.

C9.8.1 Power domains and performance monitor registers reset

For ARMv7 implementations, ARM recommends that performance monitors are implemented as part of the core power domain, not as part of a separate debug power domain. There is no interface to access the performance monitor registers when the core power domain is powered down.

The performance monitor registers must be set to their reset values on a processor reset by **nSYSPORESET**, **nCOREPORESET** or **nRESET**. Performance monitor registers are not changed by a debug logic reset by **PRESETDBGn**.

For more information about the reset scheme recommended for a v7 Debug implementation see *Recommended reset scheme for v7 Debug* on page C6-16.

C9.9 Access permissions

Normally the performance monitor registers are accessible from privileged modes only. Setting the PMUSERENR.EN flag to 1 permits access from User mode code, for example for instrumentation and profiling purposes, see *c9, User Enable Register (PMUSERENR)* on page C10-117. However, the PMUSERENR does not provide access to the registers that control interrupt generation.

Table C9-2 Performance monitor access permissions

Register	Operation	Access from a privileged mode	Access from User mode ^a	
			PMUSERENR.EN == 0	PMUSERENR.EN == 1
PMCR	MRC or MCR	Proceed	UNDEFINED	Proceed
PMCNTENSET	MRC or MCR	Proceed	UNDEFINED	Proceed
PMCNTENCLR	MRC or MCR	Proceed	UNDEFINED	Proceed
PMOVSr	MRC or MCR	Proceed	UNDEFINED	Proceed
PMSWINC	MRC	UNPREDICTABLE	UNDEFINED	UNPREDICTABLE
	MCR	Proceed	UNDEFINED	Proceed
PMSELR	MRC or MCR	Proceed	UNDEFINED	Proceed
PMCCNTR	MRC or MCR	Proceed	UNDEFINED	Proceed
PMXEVTYPER	MRC or MCR	Proceed	UNDEFINED	Proceed
PMXEVCNTR	MRC or MCR	Proceed	UNDEFINED	Proceed
PMUSERENR ^a	MRC	Proceed	Proceed	Proceed
	MCR	Proceed	UNDEFINED	UNDEFINED
PMINTENSET	MRC or MCR	Proceed	UNDEFINED	UNDEFINED
PMINTENCLR	MRC or MCR	Proceed	UNDEFINED	UNDEFINED
Reserved ^b	MRC or MCR	UNPREDICTABLE	UNDEFINED	UNDEFINED

a. For details of the EN flag see *c9, User Enable Register (PMUSERENR)* on page C10-117.

b. All the registers marked as reserved in Table C9-1 on page C9-10.

C9.10 Event numbers

The event numbers are described in the following subsections:

- *Common feature event numbers*
- *Implementation defined feature event numbers* on page C9-16.

C9.10.1 Common feature event numbers

For the common features, normally the counters must increment only once for each event. Exceptions to this rule are stated in the individual definitions.

In these definitions, the term *architecturally executed* means that the instruction flow is such that the counted instruction would have been executed in a simple sequential execution model.

———— **Note** ————

An instruction is architecturally executed if the behavior of the program on the processor is consistent with the instruction having been executed on a simple execution model of the architecture. Therefore an instruction that has been executed and retired is defined to be *architecturally executed*. In processors that perform speculative execution, an instruction is not architecturally executed if the results of the speculative execution are discarded. Where an instruction has no visible effect, for example, a NOP, the point where the instruction is retired is IMPLEMENTATION DEFINED.

The common feature event number assignments are:

0x00	Software increment. The register is incremented only on writes to the Software Increment Register. For details see <i>c9, Software Increment Register (PMSWINC)</i> on page C10-112.
0x01	Instruction fetch that causes a refill of at least the level of instruction or unified cache closest to the processor. Each instruction fetch that causes a refill from outside the cache is counted. Accesses that do not cause a new cache refill, but are satisfied from refilling data of a previous miss, are not counted. Where an instruction fetch fetches multiple instructions, the fetch counts a single event. CP15 cache maintenance operations do not count as events. This counter increments on speculative instruction fetches as well as on fetches of instructions that reach execution.
0x02	Instruction fetch that causes a TLB refill of at least the level of TLB closest to the processor. Each instruction fetch that causes an access to a level of memory system due to a translation table walk or an access to another level of TLB caching is counted. CP15 TLB maintenance operations do not count as events. This counter increments on speculative instruction fetches as well as on fetches of instructions that reach execution.
0x03	Memory Read or Write operation that causes a refill of at least the level of data or unified cache closest to the processor. Each memory read from or write to that causes a refill from outside the cache is counted. Accesses that do not cause a new cache refill, but are satisfied

from refilling data of a previous miss are not counted. Each access to a cache line that causes a new linefill is counted, including the multiple accesses of load or store multiples, including PUSH and POP. Write-Through writes that hit in the cache do not cause a linefill and so are not counted.

CP15 cache maintenance operations do not count as events.

This counter increments on speculative memory accesses as well as for memory accesses that are explicitly made by instructions.

0x04 Memory Read or Write operation that causes a cache access to at least the level of data or unified cache closest to the processor. Each access to a cache line is counted including the multiple accesses of instructions such as LDM or STM.

CP15 cache maintenance operations do not count as events.

This counter increments on speculative memory accesses as well as for memory accesses that are explicitly made by instructions.

0x05 Memory Read or Write operation that causes a TLB refill of at least the level of TLB closest to the processor. Each memory read or write operation that causes a translation table walk or an access to another level of TLB caching is counted.

CP15 TLB maintenance operations do not count as events.

This counter increments on speculative memory accesses as well as for memory accesses that are explicitly made by instructions.

0x06 Memory-reading instruction architecturally executed. This counter increments for every instruction that explicitly read data, including SWP.

This counter does not increment for a conditional instruction that fails its condition code check.

0x07 Memory-writing instruction architecturally executed. The counter increments for every instruction that explicitly wrote data, including SWP.

This counter does not increment for a Store-Exclusive instruction that fails, or for a conditional instruction that fails its condition code check.

0x08 Instruction architecturally executed. This counter counts for all instructions, including conditional instructions that fail their condition code check.

0x09 Exception taken. This counts for each exception taken.

————— **Note** —————

This event number counts the processor exceptions described in *Exceptions* on page B1-30. It does not count floating-point exceptions or ThumbEE null and index checks.

0x0A Exception return architecturally executed. This counts the exception return instructions described in *Exception return* on page B1-38.

This counter does not increment for a conditional instruction that fails its condition code check.

0x0B	<p>Instruction that writes to the CONTEXTIDR architecturally executed.</p> <p>This counter does not increment for a conditional instruction that fails its condition code check.</p>
0x0C	<p>Software change of PC, except by an exception, architecturally executed.</p> <p>This counter does not increment for a conditional instruction that fails its condition code check.</p>
0x0D	<p>Immediate branch architecturally executed:</p> <ul style="list-style-type: none"> • B{L} <label> • BLX <label> • CB{N}Z <Rn>, <label> • HB{L} #HandlerId (ThumbEE state only) • HB{L}P #<imm>, #HandlerId (ThumbEE state only). <p>This counter counts for all immediate branch instructions that are architecturally executed, including conditional instructions that fail their condition code check.</p>
0x0E	<p>Procedure return, other than exception return, architecturally executed:</p> <ul style="list-style-type: none"> • BX R14 • MOV PC, LR • POP {..., PC} • LDR PC, [SP], #offset • LDMIA R9!, {..., PC} (ThumbEE state only) • LDR PC, [R9], #offset (ThumbEE state only). <p>This counter does not increment for a conditional instruction that fails its condition code check.</p> <p style="text-align: center;">Note</p> <p>Only these instructions are counted as procedure returns. For example, the following are not counted as procedure return instructions:</p> <ul style="list-style-type: none"> • BX R0 (Rm != R14) • MOV PC, R0 (Rm != R14) • LDM SP, {..., PC} (writeback not specified) • LDR PC, [SP, #offset] (wrong addressing mode).
0x0F	<p>Unaligned access architecturally executed. This counts each instruction that is an access to an unaligned address. That is, the instruction either triggered an unaligned fault, or would have done so if the CPSR.A bit had been 1.</p> <p>This counter does not increment for a conditional instruction that fails its condition code check.</p>

0x10	Branch mispredicted or not predicted. This counts for each correction to the predicted program flow that occurs because of a misprediction from, or no prediction from, the program flow prediction resources and that relates to instructions that the program flow prediction resources are capable of predicting.
0x11	Cycle count. The register is incremented on every cycle. ————— Note ————— Unlike PMCCNTR, this count is not affected by PMCR.DP, PMCR.D or PMCR.C: <ul style="list-style-type: none">• The counter is not incremented in prohibited regions, so is not affected by PMCR.DP.• The counter increments on every cycle, regardless of the setting of PMCR.D.• The counter is reset when event counters are reset by PMCR.P, never by PMCR.C. —————
0x12	Branch or other change in program flow that could have been predicted by the branch prediction resources of the processor.
0x13-0x3F	Reserved.

C9.10.2 IMPLEMENTATION DEFINED feature event numbers

For IMPLEMENTATION DEFINED feature numbers, the counters are defined to either:

- increment only once for each event
- count the duration for which an event occurs

This property is defined individually for each feature.

ARM recommends implementers to establish house styles for the IMPLEMENTATION DEFINED events, with common definitions, and common count numbers, applied to all the processors they implement. In general, the recommended approach is for standardization across implementations with common features. However, ARM recognizes that attempting to standardize the encoding of microarchitectural features across too wide a range of implementations is not productive.

ARM strongly recommends that at least the following classes of event are identified in the IMPLEMENTATION DEFINED events:

- Cumulative duration of stalls due to the holes in the instruction availability, separating out counts for key buffering points that might exist.
- Cumulative duration of stalls due to data dependent stalling, separating out counts for key dependency classes that might exist.
- Cumulative duration of stalls due to unavailability of execution resources (including write buffers, for example), separating out counts for key resources that might exist.
- Missed superscalar issue opportunities, if relevant, separating out counts for key classes of issue that might exist.
- Miss rates for different levels of caches and TLB.

- Transaction counts on external buses.
- External events passed into the processor via an IMPLEMENTATION DEFINED mechanism. ~~Typically this involves counting the number of cycles for which the signal is asserted using the duration count option.~~
- Cumulative duration for which the CPSR.I and CPSR.F interrupt mask bits are set to 1.
- Any other microarchitectural features that the implementer considers it valuable to count.

IMPLEMENTATION DEFINED feature numbers are 0x40 to 0xFF.

Chapter C10

Debug Registers Reference

This chapter gives a reference description of the debug registers. See *Debug register map* on page C6-18 for a list of all the debug registers.

This chapter contains the following sections:

- *Accessing the debug registers* on page C10-2
- *Debug identification registers* on page C10-3
- *Control and status registers* on page C10-10
- *Instruction and data transfer registers* on page C10-40
- *Software debug event registers* on page C10-48
- *OS Save and Restore registers, v7 Debug only* on page C10-75
- *Memory system control registers* on page C10-80
- *Management registers, ARMv7 only* on page C10-88
- *Performance monitor registers* on page C10-105.

C10.1 Accessing the debug registers

In this chapter:

- The debug registers are numbered sequentially from 0 to 1023.
- The register offsets refer to the offsets in the v7 Debug memory-mapped or external debug interface. The locations of these registers in the ARMv6 external debug interface might differ.

There is a standard mapping from debug register number to coprocessor instructions in the Extended CP14 interface, see *Extended CP14 interface* on page C6-33. The register numbers and offsets for the DBGDSCR, DBGDTRRX, and DBGDTRTX Registers apply only to the external view of that register. For more information, see *Internal and external views of the DBGDSCR and the DCC registers* on page C6-21.

Note

- The recommended v7 Debug external debug interface is described in *ARM Debug Interface v5 Architecture Specification*.
 - Contact ARM if you require details of the ARMv6 recommended external debug interface.
-

C10.2 Debug identification registers

This section contains the following subsections:

- *Debug ID Register (DBGDIDR)*
- *Debug Device ID Register (DBGDEVID)* on page C10-6
- *Debug ROM Address Register (DBGDRAR)* on page C10-7
- *Debug Self Address Offset Register (DBGDSAR)* on page C10-8.

C10.2.1 Debug ID Register (DBGDIDR)

The Debug ID Register, DBGDIDR, specifies:

- which version of the Debug architecture is implemented
- some features of the debug implementation.

The DBGDIDR is:

- debug register 0, at offset 0x000
- a read-only register
- required on all versions of the Debug architecture from v6 Debug onwards
- when the Security Extensions are implemented, a Common register.

The format of the DBGDIDR is:

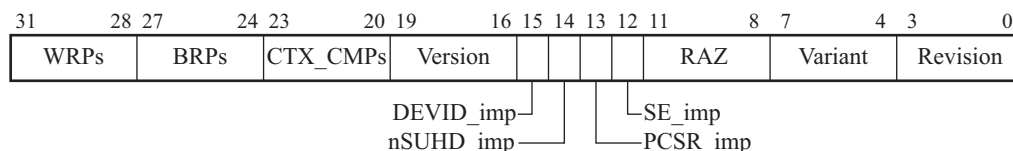

WRPs, bits [31:28]

The number of *Watchpoint Register Pairs* (WRPs) implemented. The meanings of the values of this field are:

- | | |
|---------------|--------------------|
| 0b0000 | 1 WRP implemented |
| 0b0001 | 2 WRPs implemented |
| 0b0010 | 3 WRPs implemented |

•
•
•

0b1111 16 WRPs implemented.

The minimum number of WRPs is 1.

BRPs, bits [27:24]

The number of *Breakpoint Register Pairs* (BRPs) implemented. The meanings of the values of this field are:

- 0b0000** Reserved
- 0b0001** 2 BRPs implemented
- 0b0010** 3 BRPs implemented
- •
- •
- •
- 0b1111** 16 BRPs implemented.

The minimum number of BRPs is 2.

CTX_CMPs, bits [23:20]

The number of BRPs that can be used for Context ID comparison. The meanings of the values of this field are:

- 0b0000** 1 BRP can be used for Context ID comparison
- 0b0001** 2 BRPs can be used for Context ID comparison
- 0b0010** 3 BRPs can be used for Context ID comparison
- •
- •
- •
- 0b1111** 16 BRPs can be used for Context ID comparison.

The minimum number of BRPs with Context ID comparison capability is 1. The value in this field cannot be greater than the value in the BRPs field, bits [27:24].

The breakpoint comparators with Context ID comparison capability *must* be the highest addressed comparators. For example, if six comparators are implemented and two have Context ID comparison capability, the comparators with Context ID comparison capability must be comparators 4 and 5.

Version, bits [19:16]

The Debug architecture version. The permitted values of this field are:

- 0b0001** ARMv6, v6 Debug architecture
- 0b0010** ARMv6, v6.1 Debug architecture
- 0b0011** ARMv7 Debug architecture - Extended CP14 interface implemented
- 0b0100** ARMv7 Debug architecture - No Extended CP14 interface implemented.

All other values are reserved.

DEVID_imp, bit [15]

Debug Device ID Register, DBGDEVID, implemented bit. The meanings of the values of this bit are:

- 0** DBGDEVID is not implemented. Debug register 1010 is reserved.

- 1** DBGDEVID is implemented, see *Debug Device ID Register (DBGDEVID)* on page C10-6.

This bit is always RAZ in ARMv6.

nSUHD_imp, bit [14]

Secure User halting debug not implemented bit. When the Security Extensions are implemented, the meanings of the values of this bit are:

- 0** Secure User halting debug is implemented
1 Secure User halting debug is not implemented.

If the Security Extensions are not implemented:

- Secure User halting debug cannot be implemented
- this bit is RAZ.

A v6.1 Debug processor that implements the Security Extensions must support Secure User halting debug. In v6.1 Debug this bit is always RAZ.

See also Chapter C2 *Invasive Debug Authentication*.

PCSR_imp, bit [13]

Program Counter Sampling Register (DBGPCSR) implemented as register 33 bit. The meanings of the values of this bit are:

- 0** DBGPCSR is not implemented as register 33
1 DBGPCSR is implemented as register 33.

————— **Note** —————

In v7 Debug, the DBGPCSR can be implemented as register 33, as register 40, or as both register 33 and register 40, as described in *Implemented Program Counter sampling registers* on page C8-2. The PCSR_imp bit only indicates whether it is implemented as register 33. For details of how to determine whether it is implemented as register 40 see *Debug Device ID Register (DBGDEVID)* on page C10-6.

In ARMv6, the Program Counter Sampling Register is an IMPLEMENTATION DEFINED feature of the external debug interface and is not indicated in the DBGDIDR. This bit is always RAZ in ARMv6.

See also *Program Counter Sampling Register (DBGPCSR)* on page C10-38.

SE_imp, bit [12]

Security Extensions implemented bit. The meanings of the values of this bit are:

- 0** Security Extensions are not implemented
1 Security Extensions are implemented.

v6 Debug is not a permitted option for an implementation that includes the Security Extensions. This bit is RAZ on a v6 Debug implementation.

Bits [11:8] Reserved, RAZ.

Variant, bits [7:4]

This field holds an IMPLEMENTATION DEFINED variant number. This number is incremented on functional changes. The value must match bits [23:20] of the CP15 Main ID Register.

Revision, bits [3:0]

This field holds an IMPLEMENTATION DEFINED revision number. This number is incremented on functional changes. The value must match bits [3:0] of the CP15 Main ID Register.

For details of the CP15 Main ID Register see:

- *c0*, Main ID Register (MIDR) on page B3-81, for a VMSA implementation
- *c0*, Main ID Register (MIDR) on page B4-32, for a PMSA implementation.

C10.2.2 Debug Device ID Register (DBGDEVID)

The Debug Device ID Register, DBGDEVID, extends the DBGDIDR by describing other features of the debug implementation.

The DBGDEVID register is:

- debug register 1010, at offset 0xFC8
- a read-only register
- an optional register, that can be implemented only in v7 Debug
- when the Security Extensions are implemented, a Common register.

The DBGDIDR.DEVID_imp bit indicates whether the DBGDEVID register is implemented, see *Debug ID Register (DBGDIDR)* on page C10-3.

If the DBGDEVID register is not implemented:

- the Program Counter Sampling Register (DBGPCSR) is not implemented as register 40
- the Context ID Sampling Register (DBGCIDSRS) is not implemented.

The format of the DBGDEVID register is:



Bits [31:4] Reserved, RAZ.

PCsample, bits [3:0]

This field indicates the level of Program Counter sampling support using debug registers 40 and 41. The permitted values of this field are:

- 0b0000** Program Counter Sampling Register (DBGPCSR) is not implemented as register 40, and Context ID Sampling Register (DBGCIDSRS) is not implemented.
- 0b0001** DBGPCSR is implemented as register 40, and DBGCIDSRS is not implemented.

0b0010 DBGPCSR is implemented as register 40, and DBGCIDSR is implemented as register 41.

Other values are reserved.

————— **Note** —————

The DBGPCSR can be implemented as register 33, as register 40, or as both register 33 and register 40, as described in *Implemented Program Counter sampling registers* on page C8-2. The PCsample field only indicates whether it is implemented as register 40. For details of how to determine whether it is implemented as register 33 see *Debug ID Register (DBGDIDR)* on page C10-3.

C10.2.3 Debug ROM Address Register (DBGDRAR)

The Debug ROM Address Register, DBGDRAR, defines the base address of a ROM Table, that locates and describes the debug components in the system.

The DBGDRAR is:

- Only implemented through the Baseline CP14 interface, and therefore does not have a register number and offset. For more information, see *The CP14 debug register interfaces* on page C6-32.
- A read-only register.
- Implemented as follows:
 - ARMv6** This register is not defined in ARMv6.
 - v7 Debug** If no Memory-mapped debug components, including this processor, are implemented, this register is RAZ.
 - Otherwise, the register defines the physical address in memory of a ROM Table.
- When the Security Extensions are implemented, a Common register.

It is IMPLEMENTATION DEFINED how the processor determines the value that is returned as the ROM Table address. If the processor cannot determine the value, the Valid field in the register must be RAZ.

One implementation scheme is to provide inputs **DBGROMADDR[31:12]** and **DBGROMADDRV** that a system designer must tie-off to the correct value. **DBGROMADDRV** must be tied HIGH only if **DBGROMADDR[31:12]** is tied off to a valid value, otherwise **DBGROMADDR[31:12]** and **DBGROMADDRV** must be tied LOW.

The format of the DBGDRAR is:

31	12 11	2 1 0
DBGROMADDR[31:12]	Reserved, RAZ	Valid

This register format applies regardless of the implementation scheme for identifying the ROM Table address.

DBGROMADDR[31:12], bits [31:12]

Bits [31:12] of the ROM Table physical address. Bits [11:0] of the address are zero.

If the Valid field, bits [1:0], is zero the value of this field is UNKNOWN.

Bits [11:2] Reserved, RAZ.

Valid, bits [1:0]

This field indicates whether the ROM Table address is valid. In the recommended implementation it reflects the value of the **DBGROMADDRV** signal, and the permitted values of this field are:

0b00 **DBGROMADDRV** is LOW, ROM Table address is not valid

0b11 **DBGROMADDRV** is HIGH, ROM Table address is valid.

Other values are reserved.

The ROM Table contains a zero-terminated list of signed 32-bit offsets from the ROM Table base to other Memory-mapped debug components in the system. All the debug components pointed to must contain a set of debug component identification registers compatible with the format in *Debug Component Identification Registers (DBGCID0 to DBGCID3)* on page C10-102. For more information, see the *ARM Debug Interface v5 Architecture Specification*.

C10.2.4 Debug Self Address Offset Register (DBGDSAR)

The Debug Self Address Offset Register, DBGDSAR, defines the offset from the ROM Table physical address to the physical address of the debug registers for the processor.

The DBGDSAR is:

- Only implemented through the Baseline CP14 interface, and therefore does not have a register number and offset. For more information, see *The CP14 debug register interfaces* on page C6-32.
- A read-only register.
- Implemented as follows:
 - ARMv6** This register is not defined in ARMv6.
 - v7 Debug** If no memory-mapped interface is provided, this register is RAZ. Otherwise, the register gives the offset from the ROM Table physical address to the physical address of the debug registers for the processor.
- When the Security Extensions are implemented, a Common register.

It is IMPLEMENTATION DEFINED how the processor determines the value that is returned as the debug self address offset. If the processor cannot determine the value, the Valid field in the register must be RAZ.

One implementation scheme is to provide inputs **DBGSELFADDR[31:12]** and **DBGSELFADDRV** that a system designer must tie-off to the correct value. **DBGSELFADDRV** must be tied HIGH only if **DBGSELFADDR[31:12]** is tied off to a valid value, otherwise **DBGSELFADDR[31:12]** and **DBGSELFADDRV** must be tied LOW.

The format of the DBGDSAR is:

31	12 11	2 1 0
DBGSELFADDR[31:12]	Reserved, RAZ	Valid

This register format applies regardless of the implementation scheme for identifying the debug self address offset.

DBGSELFADDR [31:12], bits [31:12]

Bits [31:12] of the two's complement offset from the ROM Table physical address to the physical address where the debug registers are mapped. Bits [11:0] of the address are zero.

If the Valid field, bits [1:0], is zero the value of this field is UNKNOWN.

Bits [11:2] Reserved, RAZ.

Valid, bits [1:0]

This field indicates whether the debug self address offset is valid. In the recommended implementation it reflects the value of the **DBGSELFADDRV** signal, and the permitted values of this field are:

0b00 **DBGSELFADDRV** is LOW, offset is not valid

0b11 **DBGSELFADDRV** is HIGH, offset is valid.

Other values are reserved.

C10.3 Control and status registers

This section contains the following subsections:

- *Debug Status and Control Register (DBGDSCR)*
- *Watchpoint Fault Address Register (DBGWFAR)* on page C10-28
- *Debug Run Control Register (DBGDRCR)*, v7 Debug only on page C10-29
- *Device Power-down and Reset Control Register (DBGPRCR)*, v7 Debug only on page C10-31
- *Device Power-down and Reset Status Register (DBGPRSR)*, v7 Debug only on page C10-34
- *Program Counter Sampling Register (DBGPCSR)* on page C10-38
- *Context ID Sampling Register (DBGCIDSR)* on page C10-39.

C10.3.1 Debug Status and Control Register (DBGDSCR)

The Debug Status and Control Register, DBGDSCR, provides the main control register for the debug facilities in the ARM architecture. All debug implementations provide both internal and external views of the DBGDSCR, and it is the external view that provides control of the debug facilities. These views are referred to as:

DBGDSCRint the internal view

DBGDSCRext the external view.

For more information, see *Internal and external views of the DBGDSCR and the DCC registers* on page C6-21.

The DBGDSCR:

- In its external view:
 - is debug register 34 at offset 0x088.
 - is a read/write register, with more restricted access to some bits.
- Has the following differences in different versions of the Debug architecture:
 - v6.1 Debug and v7 Debug define additional bits in the register.
 - DBGDSCR bit [9] is defined only in v6 Debug and v6.1 Debug. It is reserved in v7 Debug.
 - Access to the register depends on the version of the Debug architecture, see *Access to the DBGDSCR* on page C10-27.
 - The behavior of RXfull and TXfull on reads of DBGDSCR through the internal and external views is different, see *Access controls on the external view of the DCC registers and DBGITR*, v7 Debug only on page C10-21.
- When the Security Extensions are implemented, is a Common register.

In v7 Debug, the format of the DBGDSCR is:

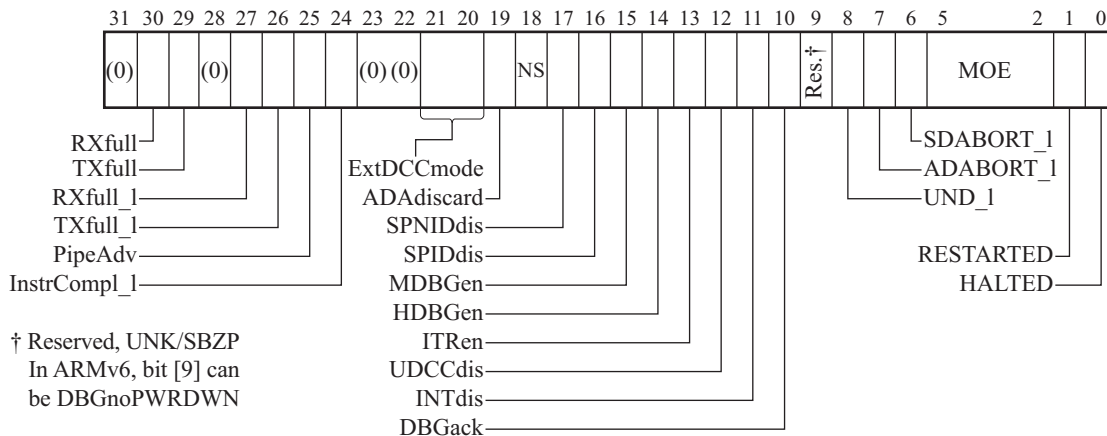

Bits [31,28,23:22]

Reserved, UNK/SBZP.

RXfull, bit [30]

The DBGDTRRX Register full bit. The possible values of this bit are:

- 0** DBGDTRRX Register empty
- 1** DBGDTRRX Register full.

Normally, RXfull is:

- set to 1 on writes to DBGDTRRXext
- cleared to 0 on reads of DBGDTRRXint.

For more information about the behavior of RXfull and the DBGDTRRX Register see *Host to Target Data Transfer Register (DBGDTRRX)* on page C10-40.

TXfull, bit [29]

The DBGDTRTX Register full bit. The possible values of this bit are:

- 0** DBGDTRTX Register empty
- 1** DBGDTRTX Register full.

Normally, TXfull is:

- cleared to 0 on reads of DBGDTRTXext
- set to 1 on writes to DBGDTRTXint.

For more information about the behavior of TXfull and the DBGDTRTX Register see *Target to Host Data Transfer Register (DBGDTRTX)* on page C10-43.

RXfull_1, bit [27], v7 Debug only

The latched RXfull bit. This is a copy of the RXfull bit taken as a side-effect of a read of DBGDSCRExt. This means that RXfull_1 holds the last value of RXfull read from DBGDSCRExt:

- On a read of DBGDSCRExt that is permitted to have side-effects, the value of RXfull_1 is the same as the value of RXfull.
- On a read of DBGDSCRint, the value of RXfull_1 is UNKNOWN.

Normally, RXfull_1 is set to 1 on writes to DBGDTRRXext.

The RXfull_1 bit controls the behavior of the processor on writes to DBGDTRRXext. For more information about the behavior of RXfull_1 and the DBGDTRRX Register, see *Host to Target Data Transfer Register (DBGDTRRX)* on page C10-40.

TXfull_1, bit [26], v7 Debug only

The latched TXfull bit. This is a copy of the TXfull bit taken as a side-effect of a read of DBGDSCRExt. This means that TXfull_1 holds the last value of TXfull read from DBGDSCRExt:

- On a read of DBGDSCRExt that is permitted to have side-effects, the value of TXfull_1 is the same as the value of TXfull.
- On a read of DBGDSCRint, the value of TXfull_1 is UNKNOWN.

Normally, TXfull_1 is cleared to 0 on reads of DBGDTRTXext.

The TXfull_1 bit controls the behavior of the processor on reads of DBGDTRTXext. For more information about the behavior of TXfull_1 and the DBGDTRTX Register see *Target to Host Data Transfer Register (DBGDTRTX)* on page C10-43.

PipeAdv, bit [25], v7 Debug only

Sticky Pipeline Advance bit. This bit is set to 1 every time the processor pipeline retires one instruction. It is cleared to 0 by a write to DBGDRCR[3], see *Debug Run Control Register (DBGDRCR)*, v7 Debug only on page C10-29.

This flag enables a debugger to detect that the processor is idle. In some situations this might indicate that the processor is deadlocked.

InstrCompl_1, bit [24], v7 Debug only

The latched Instruction Complete bit. This is a copy of the Instruction Complete internal flag, taken on each read of DBGDSCRExt. InstrCompl signals whether the processor has completed execution of an instruction issued through the Instruction Transfer Register (DBGITR), see *Instruction Transfer Register (DBGITR)* on page C10-46. InstrCompl is not visible directly in any register.

On a read of DBGDSCRExt, InstrCompl_1 always returns the current value of InstrCompl. The meanings of the values of InstrCompl_1 are:

- 0** an instruction previously issued through the DBGITR has not completed its changes to the architectural state of the processor
- 1** all instructions previously issued through the DBGITR have completed their changes to the architectural state of the processor.

Normally, InstrCompl:

- is cleared to 0 following issue of an instruction through DBGITR
- becomes 1 once the instruction completes.

The taking of an exception marks the completion of the instruction. InstrCompl is set to 1 if an instruction generates an Undefined Instruction or Data Abort exception.

InstrCompl is set to 1 on entry to Debug state. For more information about the behavior of InstrCompl, InstrCompl_1 and the DBGITR, see:

- *Instruction Transfer Register (DBGITR)* on page C10-46
- *Host to Target Data Transfer Register (DBGDTRRX)* on page C10-40
- *Target to Host Data Transfer Register (DBGDTRTX)* on page C10-43.

Bits [27:24], v6 Debug and v6.1 Debug only

Reserved, UNK/SBZP.

ExtDCCmode, bits [21:20], v7 Debug only

The External DCC access mode field. This field controls the access mode for the external views of the DCC registers and the Instruction Transfer Register (DBGITR). Possible values are:

- 0b00** Non-blocking mode
- 0b01** Stall mode
- 0b10** Fast mode.

The values of 0b11 is reserved.

For details of the external DCC access modes see *Access controls on the external view of the DCC registers and DBGITR, v7 Debug only* on page C10-21.

Bits [21:20], v6 Debug and v6.1 Debug only

Reserved, UNK/SBZP.

ADAdiscard, bit [19], v6.1 Debug and v7 Debug

Asynchronous Data Aborts Discarded bit. The possible values of this bit are:

- 0** Asynchronous aborts handled normally
- 1** On an asynchronous abort, the processor sets the Sticky Asynchronous Data Abort bit, ADABORT_1, to 1 but otherwise discards the abort.

Note

The conditions for setting ADABORT_1 to 1 are different in v7 Debug and v6.1 Debug. For more information, see the description of the ADABORT_1 bit, bit [7].

It is IMPLEMENTATION DEFINED whether the hardware automatically sets this bit to 1 on entry to Debug state, see *Asynchronous aborts and entry to Debug state* on page C5-5.

The processor clears this bit to 0 on exit from Debug state.

NS, bit [18], v6.1 Debug and v7 Debug

Non-secure state status bit. If the processor implements Security Extensions, this bit indicates whether the processor is in the Secure state. The possible values of this bit are:

- 0** the processor is in the Secure state
- 1** the processor is in the Non-secure state.

If the processor does not implement Security Extensions, this bit is RAZ.

SPNIDdis, bit [17], v6.1 Debug and v7 Debug

Secure Privileged Non-Invasive Debug Disabled bit. The behavior of this bit depends on the version of the Debug architecture:

v6.1 Debug

If the processor implements Security Extensions, this bit takes the value of the inverse of the **SPNIDEN** input. Otherwise it is RAZ.

- v7 Debug** This bit is the inverse of bit [6] of the Authentication Status Register, see *Authentication Status Register (DBGAUTHSTATUS)* on page C10-96.

SPIDdis, bit [16], v6.1 Debug and v7 Debug

Secure Privileged Invasive Debug Disabled bit. The behavior of this bit depends on the version of the Debug architecture:

v6.1 Debug

If the processor implements Security Extensions, this bit takes the value of the inverse of the **SPIDEN** input. Otherwise it is RAZ.

- v7 Debug** This bit is the inverse of bit [4] of the Authentication Status Register, see *Authentication Status Register (DBGAUTHSTATUS)* on page C10-96.

Bits [19:16], v6 Debug only

Reserved, UNK/SBZP.

MDBGGen, bit [15]

Monitor debug-mode enable bit. The possible values of this bit are:

- 0** Monitor debug-mode disabled
- 1** Monitor debug-mode enabled.

If the external interface input **DBGEN** is LOW, the MDBGen bit reads as 0. The programmed value is masked until **DBGEN** is taken HIGH. When **DBGEN** goes HIGH, the value read and the behavior of the processor correspond to the programmed value.

Note

- If Halting debug-mode is enabled, by setting the HDBGen bit to 1, then the Monitor debug-mode setting is disabled regardless of the setting of the MDBGen bit.
 - It is the programmed value of the MDBGen bit, not the value returned by reads of the DBGDSCR, that is saved by the OS Save and Restore Register in a power-down sequence. For more information, see *The OS Save and Restore mechanism* on page C6-8.
-

HDBGen, bit [14]

Halting debug-mode enable bit. The possible values of this bit are:

- 0** Halting debug-mode disabled
1 Halting debug-mode enabled.

If the external interface input **DBGEN** is LOW, the HDBGen bit reads as 0. The programmed value is masked until **DBGEN** is taken HIGH. When **DBGEN** goes HIGH, the value read and the behavior of the processor correspond to the programmed value.

Note

It is the programmed value of the HDBGen bit, not the value returned by reads of the DBGDSCR, that is saved by the OS Save and Restore Register in a power-down sequence. For more information, see *The OS Save and Restore mechanism* on page C6-8.

ITRen, bit [13]

Execute ARM instruction enable bit. This bit enables the execution of ARM instructions through the DBGITR, see *Instruction Transfer Register (DBGITR)* on page C10-46. The possible values of this bit are:

- 0** ITR mechanism disabled
1 The ITR mechanism for forcing the processor to execute instructions in Debug state via the external debug interface is enabled.

Setting this bit to 1 when the processor is in Non-debug state causes UNPREDICTABLE behavior. The effect of writing to DBGITR when this bit is set to 0 is UNPREDICTABLE.

The implementation of this bit can depend on the Debug architecture version:

- ARMv6** If the external debug interface does not have a mechanism for forcing the processor to execute instructions in Debug state via the external debug interface, this bit is RAZ/WI.
- v7 Debug** This bit, and the DBGITR, are required.

UDCCdis, bit [12]

User mode access to Communications Channel disable bit. The possible values of this bit are:

- 0** User mode access to Communication Channel enabled
- 1** User mode access to Communication Channel disabled.

When this bit is set to 1, if a User mode process tries to access the DBGDIDR, DBGDSCRint, DBGDTRRXint, or DBGDTRTXint through CP14 operations, the Undefined Instruction exception is taken. Setting this bit to 1 prevents User mode access to any CP14 debug register.

INTdis, bit [11]

Interrupts Disable bit. This bit can be used to mask the taking of IRQs and FIQs. The possible values of this bit are:

- 0** interrupts enabled
- 1** interrupts disabled.

If the external debugger needs to execute a piece of code in Non-debug state as part of the debugging process, but that code must not be interrupted, the external debugger sets this bit to 1.

For example, when single stepping code in a system with a periodic timer interrupt, the period of the interrupt is likely to be more frequent than the stepping frequency of the debugger. In this situation, if the debugger steps the target without setting the INTdis bit to 1 for the duration of the step, the interrupt is pending. This means that, if interrupts are enabled in the CPSR, the interrupt is taken as soon as the processor leaves Debug state.

The INTdis bit is ignored when either:

- `DBGDSCR[15:14] == 0b00`
- **DBGEN** is LOW.

For more information about the debug authentication signals see Chapter C2 *Invasive Debug Authentication*.

Note

If implemented, the ISR always reflects the status of the IRQ and FIQ signals, regardless of the value of the INTdis bit. For more information, see *c12, Interrupt Status Register (ISR)* on page B3-150.

DBGack, bit [10]

Force Debug Acknowledge bit. A debugger can use this bit to force any implemented debug acknowledge output signals to be asserted. The possible values of this bit are:

- 0** Debug acknowledge signals under normal processor control
- 1** Debug acknowledge signals asserted, regardless of the processor state.

For details of the recommended external debug interface, see *Run-control and cross-triggering signals* on page AppxA-5 and *DBGACK and DBGCPUDONE* on page AppxA-7.

If a debugger sets this bit to 1, it can then cause the processor to execute instructions in Non-debug state, while the rest of the system behaves as if the processor is in Debug state.

Note

The effect of setting DBGack to 1 takes no account of the **DBGGEN** and **SPIDEN** signals. This means it asserts the debug acknowledge signals regardless of the invasive debug authentication settings.

Bit [9], v7 Debug

Reserved, UNK/SBZP.

DBGnoPWRDWN, bit [9], v6 Debug and v6.1 Debug only

Debug no power-down bit. This bit can be used to drive a debug no power-down output signal, **DBGNOPWRDWN**. The possible values of this bit are:

- 0** **DBGNOPWRDWN** driven LOW
- 1** **DBGNOPWRDWN** driven HIGH.

Note

- In v6 Debug and v6.1 Debug, this bit is not defined, but many implementations define DBGDSCR[9] as the DBGnoPWRDWN bit. If this bit is not implemented, DBGDSCR[9] is UNK/SBZP.
 - In v7 Debug this use of this bit is replaced by the DBGnoPWRDWN bit in the DBGPRCR, see *Device Power-down and Reset Control Register (DBGPRCR)*, v7 *Debug only* on page C10-31.
-

UND_1, bit [8], v6.1 Debug and v7 Debug

Sticky Undefined Instruction bit. This flag is set to 1 by any Undefined Instruction exceptions generated by instructions issued to the processor while in Debug state. The possible values of this bit are:

- 0** No Undefined Instruction exception has been generated since the last time this bit was cleared to 0
- 1** An Undefined Instruction exception has been generated since the last time this bit was cleared to 0.

The method of clearing this flag to 0, and the behavior of the flag, depends on the version of the Debug architecture:

v6.1 Debug

This flag is cleared to 0 when the external debugger reads the DBGDSCR.

v7 Debug This flag is cleared to 0 only by writing to bit [2] of the DBGDRCR, see *Debug Run Control Register (DBGDRCR)*, v7 *Debug only* on page C10-29.

Leaving Debug state with this flag set to 1 causes UNPREDICTABLE behavior.

When the processor is in Non-debug state, this flag is not set to 1 by an Undefined Instruction exception.

For more information, see *Exceptions in Debug state* on page C5-20.

Bit [8], v6 Debug only

Reserved, UNK/SBZP.

ADABORT_1, bit [7], v7 Debug

Sticky Asynchronous Data Abort bit. This flag is set to 1 by any asynchronous abort that occurs when the processor is in Debug state and is discarded because the ADAdiscard bit, bit [19], is set to 1. The possible values of this bit are:

- 0** No asynchronous abort has been discarded since the last time this bit was cleared to 0
- 1** An asynchronous abort has been discarded since the last time this bit was cleared to 0.

This flag is cleared to 0 only by writing to bit [2] of the DBGDRCR, see *Debug Run Control Register (DBGDRCR)*, v7 Debug only on page C10-29.

Leaving Debug state with this flag set to 1 causes UNPREDICTABLE behavior.

When the processor is in Non-debug state this flag is never set to 1 when an asynchronous abort occurs.

For more information, see *Asynchronous aborts and entry to Debug state* on page C5-5 and *Exceptions in Debug state* on page C5-20.

ADABORT_1, bit [7], v6 Debug and v6.1 Debug

Sticky Asynchronous Data Abort bit. This flag is set to 1 by any asynchronous abort that occurs when the processor is in Debug state. The possible values of this bit are:

- 0** No asynchronous abort has occurred since the last time this bit was cleared to 0
- 1** An asynchronous abort has occurred since the last time this bit was cleared to 0.

This flag is cleared to 0 when the external debugger reads the DBGDSCR.

Some aspects of the behavior of this flag depend on the version of the Debug architecture:

v6.1 Debug

If the processor is in Non-debug state this flag is not set to 1 on an asynchronous abort.

v6 Debug The value of this flag is UNKNOWN when either the processor is in Non-debug state, or the ITRen bit, bit [13], is not set to 1.

For more information, see *Asynchronous aborts and entry to Debug state* on page C5-5 and *Exceptions in Debug state* on page C5-20.

SDABORT_1, bit [6]

Sticky Synchronous Data Abort bit. This flag is set to 1 by any Data Abort exception that is generated by a synchronous data abort when the processor is in Debug state. The possible values of this bit are:

- 0** No Data Abort exception has been generated by a synchronous data abort since the last time this bit was cleared to 0
- 1** A Data Abort exception has been generated by a synchronous data abort since the last time this bit was cleared to 0.

The behavior of the DBGITR depends on the value of the SDABORT_1 bit, see *Instruction Transfer Register (DBGITR)* on page C10-46.

The method of clearing this flag to 0 depends on the version of the Debug architecture:

v7 Debug This flag is cleared to 0 only by writing to bit [2] of the DBGDRCCR, see *Debug Run Control Register (DBGDRCCR)*, v7 *Debug only* on page C10-29.

ARMv6 This flag is cleared to 0 when the external debugger reads the DBGDSCR.

Some aspects of the behavior of this flag depend on the version of the Debug architecture:

v7 Debug If the processor is in Non-debug state this flag is not set to 1 on a synchronous Data Abort exception.

Leaving Debug state with this flag set to 1 causes UNPREDICTABLE behavior.

v6.1 Debug

If the processor is in Non-debug state this flag is not set to 1 on a synchronous Data Abort exception.

v6 Debug If the processor is in Non-debug state, the value of this flag is UNKNOWN.

For more information, see *Exceptions in Debug state* on page C5-20.

MOE, bits [5:2]

Method of Debug Entry field. The permitted values of this field depend on the Debug architecture. For details of this field see *Method of Debug entry* on page C10-26.

RESTARTED, bit [1]

Processor Restarted bit. The possible values of this bit are:

- 0** The processor is exiting Debug state. This bit only reads as 0 between receiving a restart request, and restarting Non-debug state operation.
- 1** The processor has exited Debug state. This bit remains set to 1 if the processor re-enters Debug state.

After making a restart request, the debugger can poll this bit until it is set to 1. At that point it knows that the restart request has taken effect and the processor has exited Debug state.

Note

Polling the HALTED bit until it is set to 0 is not safe because the processor could re-enter Debug state as a result of another debug event before the debugger samples the DBGDSCR.

See Chapter C5 *Debug State* for a definition of Debug state.

HALTED, bit [0]

Processor Halted bit. The possible values of this bit are:

- 0** The processor is in Non-debug state.
- 1** The processor is in Debug state.

———— Note ————

Between receiving a restart request and restarting Non-debug state operation, the processor is in Debug state and this bit reads as 1

After programming a debug event, the external debugger can poll this bit until it is set to 1. At that point it knows that the processor has entered Debug state.

See Chapter C5 *Debug State* for a definition of Debug state.

Table C10-1 shows the access to each field of the DBGDSCR, and the reset value of each field. It also shows the Debug architecture versions in which each field is defined.

Table C10-1 DBGDSCR bit access and reset values

Bits	Field name	Version	Access^a	Reset value^b
[31]	-	-	UNK/SBZP	-
[30]	RXfull	All	Read-only	0
[29]	TXfull	All	Read-only	0
[28]	-	-	UNK/SBZP	-
[27]	RXfull_1	v7 Debug	Read-only	0
[26]	TXfull_1	v7 Debug	Read-only	0
[25]	PipeAdv	v7 Debug	Read-only	UNKNOWN
[24]	InstrCompl_1	v7 Debug	Read-only	UNKNOWN
[23:22]	-	-	UNK/SBZP	-
[21:20]	ExtDCCmode	v7 Debug	Read/write	00
[19]	ADAdiscard	v6.1 Debug, v7 Debug	Read-only or Read/write ^c	0
[18]	NS	v6.1 Debug, v7 Debug	Read-only	f
[17]	SPNIDdis	v6.1 Debug, v7 Debug	Read-only	f
[16]	SPIDdis	v6.1 Debug, v7 Debug	Read-only	f
[15]	MDBGGen	All	RW _{Int}	0

Table C10-1 DBGDSCR bit access and reset values (continued)

Bits	Field name	Version	Access ^a	Reset value ^b
[14]	HDBGGen	All	RW _{Ext}	0
[13]	ITRen	All	RW _{Ext}	0
[12]	UDCCdis	All	RW _{Int}	0
[11]	INTdis	All	RW _{Ext}	0
[10]	DBGack	All	RW _{Ext}	0
[9]	DBGnoPWRDWN	v6 Debug, v6.1 Debug ^d	RW _{Ext}	0
[8]	UND_1	v6.1 Debug, v7 Debug	Read-only ^e	0
[7]	ADABORT_1	All	Read-only ^e	0
[6]	SDABORT_1	All	Read-only ^e	0
[5:2]	MOE	All	RW _{Int}	0
[1]	RESTARTED	All	Read-only	f
[0]	HALTED	All	Read-only	f

- a. For more information, including the meaning of RW_{Int} and RW_{Ext}, see *Access to the DBGDSCR* on page C10-27.
- b. Debug logic reset value, the value after a debug logic reset.
- c. The ADABORT bit can be read/write. This is IMPLEMENTATION DEFINED, see *Asynchronous aborts and entry to Debug state* on page C5-5.
- d. For more information, see the v6 Debug and v6.1 Debug description of this field.
- e. For details of how these bits are cleared to 0 see the descriptions of the bits. The method depends on the Debug architecture version.
- f. These are read-only status bits that reflect the current state of the processor.

Access controls on the external view of the DCC registers and DBGITR, v7 Debug only

In v7 Debug, the DBGDSCR.ExtDCCmode field determines the external DCC access mode. This access mode, operating with flags in the DBGDSCR, controls all accesses made to DBGDTRRXext and DBGDTRTXext, and also controls some accesses to the Instruction Transfer Register DBGITR.

The DBGDSCR includes a ready flag and a latched ready flag for each of the registers DBGDTRRXext and DBGDTRTXext, and a latched ready flag for the DBGITR:

- RXfull and RXfull_1 are the ready and latched ready flags for the DBGDTRRXext register
- TXfull and TXfull_1 are the ready and latched ready flags for the DBGDTRTXext register
- InstrCompl_1 is the latched ready flag for the DBGITR.

The ready flag for the DBGITR, InstrCompl, is an internal flag that cannot be accessed through any register.

For details of the ready state of each flag, and details of when the latched flags are updated, see the descriptions of the DBGDSCR flag bits.

Different external DCC access modes require the debugger to execute different sequences of accesses to the DBGDTRRXext and DBGDTRTXext registers, and to the DBGITR. This can affect the total number of accesses required.

Table C10-2 shows the three external DCC access modes:

Table C10-2 Meaning of the external DCC access mode values

DBGDSCR.ExtDCCmode	External DCC access mode	Description
0b00	Non-blocking mode	<i>Non-blocking mode</i>
0b01	Stall mode	<i>Stall mode on page C10-23</i>
0b10	Fast mode	<i>Fast mode on page C10-23</i>

Note

- Non-blocking mode is the default setting because improper use of the other modes can result in the external debug interface becoming deadlocked.
- For information that applies to all access modes see *Restrictions on accesses to DBGITR, DBGDTRRXext and DBGDTRTXext* on page C10-25.

See *Instruction and data transfer registers* on page C10-40. The external DCC access mode field has no effect on accesses to DBGDTRRXint and DBGDTRTXint.

Non-blocking mode

When Non-blocking mode is selected, reads from DBGDTRTXext and writes to DBGDTRRXext and DBGITR are ignored when the appropriate latched *ready* flag is not in the *ready* state:

- if RXfull_1 is set to 1, writes to DBGDTRRXext are ignored
- if InstrCompl_1 is set to 0, writes to DBGITR are ignored
- if TXfull_1 is set to 0, reads from DBGDTRTXext are ignored and return an UNKNOWN value.

Following a successful write to DBGDTRRXext, RXfull and RXfull_1 are set to 1.

Following a successful read from DBGDTRTXext, TXfull and TXfull_1 are cleared to 0.

Following a successful write to DBGITR, InstrCompl and InstrCompl_1 are cleared to 0.

Debuggers accessing these registers must first read DBGDSCRExt. This has the side-effect of copying RXfull and TXfull to RXfull_l and TXfull_l, and setting InstrCompl_l. The debugger can then use the returned value to determine whether a subsequent access to these registers will be ignored.

Stall mode

When Stall mode is selected, accesses to DBGDTRRXext, DBGDTRTXext, and DBGITR are modified such that each access stalls under the following conditions:

- writes to DBGDTRRXext are not completed until RXfull is 0
- writes to DBGITR are not completed until InstrCompl is 1
- reads from DBGDTRTXext are not completed until TXfull is 1.

If an access is stalled in this way you cannot access any of the debug registers until the stalled DBGDTRRXext, DBGDTRTXext, or DBGITR access completes. For more information about stalled accesses see *Stalling of accesses to the DCC registers* on page C10-25.

Following a write to DBGDTRRXext or DBGITR, or a read from DBGDTRTXext, the flags InstrCompl, InstrCompl_l, RXfull, RXfull_l, TXfull, and TXfull_l are set as in *Non-blocking mode* on page C10-22.

———— **Note** ————

The rules used in Non-blocking mode for ignoring accesses based on the values of the latched flags InstrCompl_l, RXfull_l and TXfull_l do not apply in Stall mode.

Stall mode can be selected when the processor is in Non-debug state. However, because Stall mode blocks the interface to the debug registers until the processor issues the correct MCR or MRC instruction to unblock the access, ARM recommends that you do not use Stall mode in cases where the external debugger does not have complete control over the instructions executing on the processor.

Accesses to DBGDTRRXext and DBGDTRTXext through the Extended CP14 interface are UNPREDICTABLE when Stall mode is selected.

Fast mode

If Fast mode is selected and the DBGDSCR.ITRen bit is 0, or the processor is in Non-debug state, the results are UNPREDICTABLE.

When Fast mode is selected, a write to the DBGITR does not trigger an instruction for execution. Instead, the instruction is latched. The latched value is retained until either a new value is written to the DBGITR, or the access mode is changed.

For accesses through the external debug interface or the memory-mapped interface:

- when an instruction is latched, any read of DBGDTRTXext or write to DBGDTRRXext causes the processor to execute the latched instruction
- when no instruction is latched, any access to DBGDTRRXext or DBGDTRTXext is UNPREDICTABLE.

Any access to DBGDTRRXext or DBGDTRTXext through the Extended CP14 interface is UNPREDICTABLE.

Fast mode enables a single instruction to be executed repeatedly, without reloading the DBGITR.

In Fast mode:

- Writes to DBGITR do not trigger an instruction to be executed. If a previously issued instruction is executing, it must not be affected by the write to the DBGITR. Implementations can choose to stall the write until InstrCompl is set to 1 to achieve this requirement.
- Writes to DBGDTRRXext:
 - are not completed until InstrCompl is set to 1
 - write the data to the DBGDTRRX Register
 - issue the instruction last written to DBGITR. If the issued instruction reads from DBGDTRRXint, the instruction reads the value written to DBGDTRRXext by this write.

If RXfull is set to 1 before the write, then after the write the values of DBGDTRRX and the RXfull and RXfull_1 flags in the DBGDSCR are UNKNOWN.

- Reads from DBGDTRTXext:
 - Are not completed until InstrCompl is set to 1.
 - Return the data from the DBGDTRTX.
 - Issue the instruction last written to the DBGITR. If the issued instruction writes to DBGDTRTXint, the instruction does not affect the value returned from this read of DBGDTRTXext. That is, this instruction can write the next DBGDTRTXext value to be read.

If TXfull is set to 0 before the read, then after the read the values of DBGDTRTX and the TXfull and TXfull_1 flags in the DBGDSCR are UNKNOWN.

If a Fast mode access is stalled you cannot access any of the debug registers until the stalled DBGDTRRXext, DBGDTRTXext, or DBGITR access completes. For more information about stalled accesses see *Stalling of accesses to the DCC registers* on page C10-25.

———— **Note** —————

The rules used in Non-blocking mode for ignoring accesses based on the values of the latched flags InstrCompl_1, RXfull_1 and TXfull_1 do not apply in Fast mode.

If the DBGDSCR.SDABORT_1 bit is set to 1, reads of DBGDTRTXext and writes to DBGDTRRXext do not cause the latched instruction to be executed by the processor, and the access completes immediately. In these cases:

- reading DBGDTRTXext returns an UNKNOWN value, and the values of DBGDTRTX and the TXfull and TXfull_1 flags become UNKNOWN
- if you write to DBGDTRRXext, the values of DBGDTRRX and the RXfull and RXfull_1 flags in the DBGDSCR become UNKNOWN.

Otherwise, following a write to DBGDTRRXext or DBGITR, or a read from DBGDTRTXext, the flags InstrCompl, InstrCompl_1, RXfull, RXfull_1, TXfull, and TXfull_1 are set as in *Non-blocking mode* on page C10-22.

Stalling of accesses to the DCC registers

In Stall mode and Fast mode, accesses to the DCC registers can stall:

- The mechanism by which an access is stalled by the external debug interface must be defined by the external debug interface. For details of how accesses are stalled by the recommended ARM Debug Interface v5, see the *ARM Debug Interface v5 Architecture Specification*.
- The mechanism by which an access is stalled by the memory-mapped interface must be defined by the memory-mapped interface.
- A stall is a side-effect of an access. If the debug logic is in a state where an access has no side-effects, the access does not stall. For more information about debug logic states in which accesses have no side effects see *Permission summaries for memory-mapped and external debug interfaces* on page C6-45.

Note

When the selected DCC access mode is Stall mode or Fast mode, all accesses through the Extended CP14 interface are UNPREDICTABLE.

Restrictions on accesses to DBGITR, DBGDTRRText and DBGDTRTText

If an access is made when the OS Lock is set or when the Sticky Power-down status bit is set to 1, then:

- the access generates an error response
- register reads have no side-effects
- register writes are ignored
- the flags remain unchanged.

This applies both to accesses through the external debug interface and to accesses through the memory-mapped interface.

If an access is made through the memory-mapped interface when the Software Lock is set then:

- register reads have no side-effects
- register writes are ignored
- the flags remain unchanged.

For more information, see *Permission summaries for memory-mapped and external debug interfaces* on page C6-45.

Method of Debug entry

The Method of Debug Entry is indicated by the DBGDSCR.MOE field. Table C10-3 shows the meanings of the possible values of the DBGDSCR.MOE field, and also shows:

- the versions of the Debug architecture for which each value is permitted
- the section where the corresponding method of entry is described.

Table C10-3 Meaning of Method of Debug Entry values

MOE bits	Debug versions	Debug entry caused by:	Section, notes
0000	All	Halt Request debug event	<i>Halting debug events</i> on page C3-38.
0001	All	Breakpoint debug event.	<i>Breakpoint debug events</i> on page C3-5.
0010	All	Asynchronous Watchpoint debug event.	<i>Watchpoint debug events</i> on page C3-15.
0011	All	BKPT Instruction debug event.	<i>BKPT Instruction debug events</i> on page C3-20.
0100	All	External Debug Request debug event.	<i>Halting debug events</i> on page C3-38.
0101	All	Vector Catch debug event.	<i>Vector Catch debug events</i> on page C3-20.
0110	v6 only	D-side abort.	This MOE value is reserved in v6.1 and v7.
0111	v6 only	I-side abort.	This MOE value is reserved in v6.1 and v7.
1000	v7	OS Unlock Catch debug event.	<i>Halting debug events</i> on page C3-38. This MOE value is reserved in v6 and v6.1.
1001	All	Reserved.	-
1010	v7	Synchronous Watchpoint debug event.	<i>Watchpoint debug events</i> on page C3-15 This MOE value is reserved in v6 and v6.1.
1011-1111	All	Reserved.	-

A Prefetch Abort or Data Abort handler can determine whether a debug event occurred by checking the value of the relevant Fault Status Register, IFSR or DFSR. It then uses the DBGDSCR.MOE bits to determine the specific debug event.

In v6 Debug, the DBGDSCR can be checked first to determine whether an abort has occurred, and hence whether the abort handler jumps to the debug monitor or not. In v6.1 Debug and v7 Debug the *D-side abort occurred* and *I-side abort occurred* encodings are reserved. Therefore, an abort handler must always check the IFSR or DFSR first.

When debug is disabled, and when debug events are not permitted, the BKPT instruction generates a debug exception rather than being ignored. The DBGDSCR, IFSR, and IFAR are set as if a BKPT Instruction debug exception occurred. See *Effects of debug exceptions on CP15 registers and the DBGWFEAR* on page C4-4. For security reasons, monitor software might need to check that debug was enabled and that the debug event was permitted before communicating with an external debugger.

In v7 Debug support for synchronous watchpoint events is added, see *Synchronous and Asynchronous Watchpoint debug events* on page C3-18.

Access to the DBGDSCR

In the Access column of Table C10-1 on page C10-20, read/write bits in the DBGDSCR are indicated by either RW_{Int} or RW_{Ext} .

In v6 Debug and v6.1 Debug:

- the meanings of the RW_{Int} and RW_{Ext} indications are:
 - RW_{Int}** The bit is read/write in the internal view of the register, and read-only in the external view.
 - RW_{Ext}** The bit is read/write in the external view of the register, and read-only in the internal view.
- the internal view, DBGDSCRint, is accessed using coprocessor instructions
- the external view, DBGDSCRext, is accessed through the external debug interface.

In v7 Debug:

- all read/write bits, whether indicated by RW_{Int} or RW_{Ext} , are read/write in DBGDSCRext
- DBGDSCRext can be accessed through the Extended CP14 interface, the memory-mapped interface, and the external debug interface
- DBGDSCRint is read-only, and is accessed using coprocessor instructions.

C10.3.2 Watchpoint Fault Address Register (DBGWFAR)

The Watchpoint Fault Address Register, DBGWFAR, returns information about the address of the instruction that accessed a watchpointed address.

The DBGWFAR:

- is debug register 6 at offset 0x018
- is a read/write register
- is implemented differently in different versions of the Debug architecture:
 - v6 Debug** In v6 Debug, the DBGWFAR can be accessed only through CP15.

v6.1 Debug

In v6.1 Debug, the DBGWFAR can be accessed through the debug register interfaces, and using the CP15 access is deprecated.

- v7 Debug** In v7 Debug, the CP15 encoding used for the DBGWFAR in v6 Debug is UNDEFINED in User mode and UNPREDICTABLE in privileged modes. The DBGWFAR can be accessed only through the debug register interfaces.

The format of the DBGWFAR is:

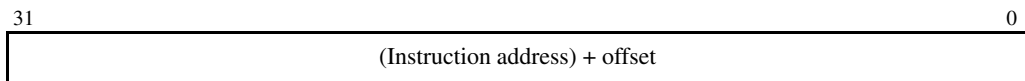

(Instruction address) + offset, bits [31:0]

When Watchpoint debug events are permitted, on every Watchpoint debug event the DBGWFAR is updated with the address of the instruction that accessed the watchpointed address plus an offset that depends on the processor instruction set state when the instruction was executed:

- 8 if the processor was in ARM state
- 4 if the processor was in Thumb or ThumbEE state
- an IMPLEMENTATION DEFINED offset if the processor was in Jazelle state.

See *Memory addresses* on page C3-23 for a definition of the *Instruction Virtual Address (IVA)* used to update the DBGWFAR.

The debug logic reset value of the DBGWFAR is UNKNOWN.

A processor with a trivial implementation of the Jazelle extension can implement DBGWFAR[0] as RAZ/WI, see *Trivial implementation of the Jazelle extension* on page B1-81 for more information. In such an implementation, software must use a SBZP policy when writing to DBGWFAR[0].

C10.3.3 Debug Run Control Register (DBGDRCR), v7 Debug only

The Debug Run Control Register, DBGDRCR, requests the processor to enter or leave Debug state. It is also used to clear to 0 the sticky exception bits in the DBGDSCR.

The DBGDRCR is:

- debug register 36, at offset 0x090
- a write-only register
- implemented only in v7 Debug
- when the Security Extensions are implemented, a Common register.

In v6 Debug and v6.1 Debug, register 36 is not defined.

The format of the DBGDRCR is:

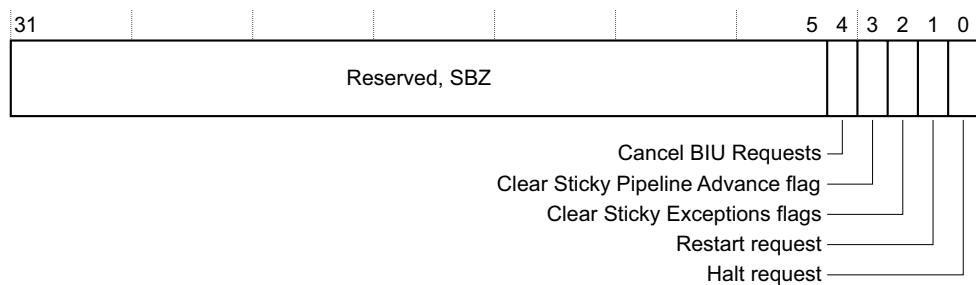

Bits [31:5] Reserved, SBZ.

Cancel BIU Requests, bit [4]

Cancel Bus Interface Unit Requests bit. The actions on writing to this bit are:

- 0** no action
- 1** cancel pending accesses.

See *Cancel Bus Interface Unit (BIU) Requests* on page C10-30. It is IMPLEMENTATION DEFINED whether this feature is supported. If this feature is not implemented, writes to this bit are ignored.

It is UNPREDICTABLE whether a write of 1 to this bit has any effect when the processor is powered-down.

Clear Sticky Pipeline Advance flag, bit [3]

This bit is used to clear the DBGDSCR.PipeAdv bit, the Sticky Pipeline Advance bit, to 0. The actions on writing to this bit are:

- 0** no action
- 1** clear the DBGDSCR.PipeAdv bit to 0.

When the processor is powered down, it is UNPREDICTABLE whether a write of 1 to this bit clears DBGDSCR.PipeAdv to 0.

Clear Sticky Exceptions flags, bit [2]

This bit is used to clear the sticky exceptions flags in the DBGDSCR to 0. The actions on writing to this bit are:

- 0** no action
- 1** clear DBGDSCR[8:6] to 0b000.

Writing 1 to this bit clears the DBGDSCR.UND_1, DBGDSCR.ADABORT_1, and DBGDSCR.SDABORT_1 sticky exceptions flags, DBGDSCR[8:6], to 0b000.

When the processor is in Non-debug state, it is UNPREDICTABLE whether a write of 1 to this bit clears DBGDSCR[8:6] to 0b000.

When the processor is in Debug state, it can leave Debug state by performing a single write to DBGDRCR with DBGDRCR[2:1] = 0b11. This:

- clears DBGDSCR[8:6] to 0b000
- requests exit from Debug state.

Restart request, bit [1]

Restart request bit. The actions on writing to this bit are:

- 0** no action
- 1** request exit from Debug state.

Writing 1 to this bit requests that the processor leaves Debug state. This request is held until the processor exits Debug state.

Once the request has been made, the debugger can poll the DBGDSCR.RESTARTED bit until it reads 1.

Writes to this bit are ignored if the processor is in Non-debug state.

Halt request, bit [0]

Halt request bit. The actions on writing to the this bit are:

- 0** no action
- 1** request entry to Debug state.

Writing 1 to this bit requests that the processor enters Debug state. This request is held until the processor enters Debug state, see *Halting debug events* on page C3-38.

Once the request has been made, the debugger can poll the DBGDSCR.HALTED bit until it reads 1.

Writes to this bit are ignored if the processor is already in Debug state.

Cancel Bus Interface Unit (BIU) Requests

When support for Cancel BIU Requests is implemented, if 1 is written to the Cancel BIU Requests bit, the processor cancels any pending Bus Interface Unit Request accesses until Debug state is entered. This means it cancels any pending accesses to the system bus. When this request is made an implementation must abandon all data load and store accesses. It is IMPLEMENTATION DEFINED whether other accesses, including instruction fetches and cache operations, are also abandoned.

Debug state entry is the acknowledge event that clears this request.

Abandoned accesses have the following behavior:

- an abandoned data store writes an UNKNOWN value to the target address
- an abandoned data load returns an UNKNOWN value to the register bank
- an abandoned instruction fetch returns an UNKNOWN instruction for execution
- an abandoned cache operation leaves the memory system in an UNPREDICTABLE state.

However, an abandoned access does not cause any exception.

Additional BIU requests, after Debug state has been entered, have UNPREDICTABLE behavior.

The number of ports on the processor and their protocols are implementation specific and, therefore, the detailed behavior of this bit is IMPLEMENTATION DEFINED. It is also IMPLEMENTATION DEFINED whether this behavior is supported on all ports of a processor. For example, an implementation can choose not to implement this behavior on instruction fetches.

This control bit enables the debugger to release a deadlock on the system bus so Debug state can be entered. This Debug state entry is imprecise, because the debugger only wants to know what the state of the processor was at the time the deadlock occurred. At the point where the deadlock is released, one of the following must be pending:

- a Halt request, made by also writing 1 to the Halt request bit of the DBGDRCR
- an External Debug request.

It might not be easy to infer the cause of the deadlock by reading the PC value after entering Debug state if, for example, either:

- the processor has a non-blocking cache design or a write buffer
- the deadlocked access corresponded to a load to the PC.

The effect of this bit depends on the state of the external debug interface signals:

- If the processor implements Security Extensions, a write to this bit is ignored unless **DBGEN** and **SPIDEN** are both HIGH, meaning that invasive debug is permitted in all processor states and modes.
- If the processor does not implement Security Extensions, a write to this bit is ignored unless **DBGEN** is HIGH.

For details of invasive debug authentication see Chapter C2 *Invasive Debug Authentication*.

C10.3.4 Device Power-down and Reset Control Register (DBGPRCR), v7 Debug only

The Device Power-down and Reset Control Register, DBGPRCR, controls processor functionality related to reset and power-down.

The DBGPRCR is:

- debug register 196, at offset 0x310
- a read/write register, with more restricted access to some bits
- implemented only in v7 Debug
- when the Security Extensions are implemented, a Common register.

In v6 Debug and v6.1 Debug, register 196 is not defined.

The format of the DBGPRCR is:

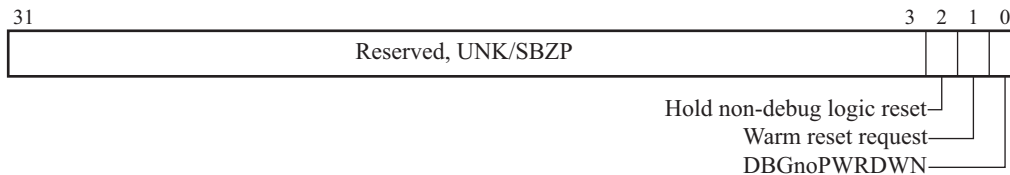

Bits [31:3] Reserved, UNK/SBZP.

Hold non-debug logic reset, bit [2]

The effects of the possible values of this bit are:

- 0** Do not hold the non-debug logic reset on power-up or warm reset.
- 1** Hold the non-debug logic of the processor in reset on power-up or warm reset. The processor is held in this state until this flag is cleared to 0.

Hold non-debug logic reset is an IMPLEMENTATION DEFINED feature. If it is implemented writing 1 to this bit means the non-debug logic of the processor is held in reset after a power-up or warm reset.

Note

This bit never affects system power-up, because when implemented it resets to 0.

An external debugger can use this bit to prevent the processor running again before the debugger has had the chance to detect a power-down occurrence and restore the state of the debug registers inside the core power domain. Also, this bit can be used in conjunction with an external reset controller to take the processor into reset and hold it there while the rest of the system comes out of reset. This means a debugger can hold the processor in reset while programming other debug registers.

The effect of this bit depends on the state of the external debug interface signals:

- If the processor implements the Security Extensions, the value of this bit is ignored unless both the external debug interface signals **DBGGEN** and **SPIDEN** are HIGH, meaning that invasive debug is permitted in all processor states and modes.
- If the processor does not implement the Security Extensions, the value of this bit is ignored unless **DBGGEN** is HIGH.

For details of invasive debug authentication see Chapter C2 *Invasive Debug Authentication*.

If both features are supported, the bit can be written at the same time as the Warm reset request bit to force the processor into reset and hold it there, for example while programming other debug registers such as setting the Halt request bit of the DBGDRCR to take the processor into Debug state on leaving Reset. For more information, see *Debug Run Control Register (DBGDRCR)*, v7 Debug only on page C10-29.

Note

When this bit is set to 1 the processor is not held in Debug state, and cannot enter Debug state until released from reset. While the processor is held in reset it must not accept instructions issued via the Instruction Transfer Register (DBGITR).

If Hold non-debug logic reset is not implemented this bit is RAZ/WI.

Warm reset request, bit [1]

The actions on writing to the Warm reset request bit are:

- 0** no action
- 1** request internal reset.

Warm reset request is an IMPLEMENTATION DEFINED feature. If it is implemented writing 1 to this bit issues a request for a warm reset. Typically the request is passed to an external reset controller. This means that even when a processor implements Warm reset request, whether a request causes a reset might be an IMPLEMENTATION DEFINED feature of the system that contains the processor.

Note

- This bit is always RAZ. Software must read the Sticky Reset status bit in the DBGPRSR to determine the current reset status of the processor, see *Device Power-down and Reset Status Register (DBGPRSR)*, v7 *Debug only* on page C10-34.
- Warm reset request does not request the reset of any registers that are only reset on a debug logic reset.

The external debugger can use this bit to force the processor into reset if it does not have access to the **nRESET** input. The reset behavior is the same as warm reset driven by the **nRESET** signal. A warm reset does not cause power-down.

The effect of this bit depends on the state of the external debug interface signals:

- If the processor implements the Security Extensions, a write to this bit is ignored unless both the external debug interface signals **DBGEN** and **SPIDEN** are HIGH, meaning that invasive debug is permitted in all processor states and modes.
- If the processor does not implement the Security Extensions, a write to this bit is ignored unless **DBGEN** is HIGH.

For details of invasive debug authentication see Chapter C2 *Invasive Debug Authentication*.

Unless Hold non-debug logic reset, bit [2], is set to 1, the reset must be held only for long enough to reset the processor. The processor then leaves the reset state.

Note

If an implementation supports both features, both the Warm reset request and Hold non-debug logic reset bits can be set to 1 in a single write to the DBGPRCR. In this case the processor enters reset and is held there.

If Warm reset request is not implemented this bit is RAZ/WI.

DBGnoPWRDWN, bit [0]

No power-down bit, DBGnoPWRDWN. This bit controls the **DBGNOPWRDWN** signal, if it is implemented. The possible values of this bit are:

- 0** drive **DBGNOPWRDWN** LOW
- 1** drive **DBGNOPWRDWN** HIGH.

DBGNOPWRDWN is an IMPLEMENTATION DEFINED feature. If it is implemented, setting this bit drives the **DBGNOPWRDWN** signal HIGH, requesting the power controller to work in an emulation mode where the processor is not actually powered down when requested. For more information, see *DBGNOPWRDWN* on page AppxA-9.

If the **DBGNOPWRDWN** signal is not implemented this bit is RAZ/WI.

C10.3.5 Device Power-down and Reset Status Register (DBGPRSR), v7 Debug only

The Device Power-down and Reset Status Register, DBGPRSR, holds information about the reset and power-down state of the processor.

The DBGPRSR is:

- debug register 197, at offset 0x314
- a read-only register, with reads of the register also resetting some register bits
- implemented only in v7 Debug
- when the Security Extensions are implemented, a Common register.

In v6 Debug and v6.1 Debug, register 197 is not defined.

The format of the DBGPRSR is:

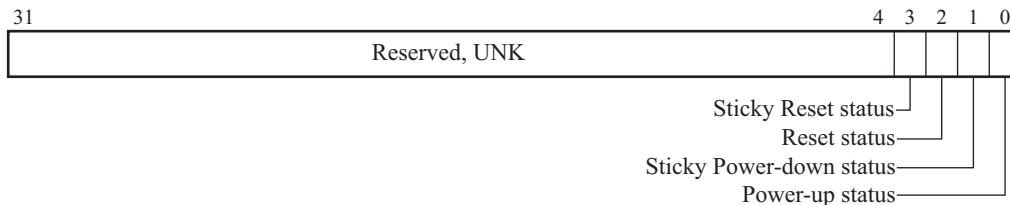

Bits [31:4] Reserved, UNK.

Sticky Reset status, bit [3]

The meanings of the Sticky Reset status bit values are:

- 0** the non-debug logic of the processor has not been reset since the last time this register was read
- 1** the non-debug logic of the processor has been reset since the last time this register was read.

This bit is cleared to 0 on a read of the DBGPRSR when the non-debug logic of the processor is not in reset state.

When the non-debug logic of the processor is in reset state, the Sticky Reset status bit is set to 1.

Reads of DBGPRSR made when the non-debug logic of the processor is in reset state return 1 for Sticky Reset status and do not change the value of Sticky Reset status.

Reads of DBGPRSR made when the non-debug logic of the processor is not in reset state return the current value of Sticky Reset status, and then clear Sticky Reset status to 0.

Note

- *Reset state* is defined in *Reset state* on page C10-37.
 - On a read access, the Sticky Reset status bit can be cleared only as a side effect of the read. When a read is made through the memory-mapped interface with the Software Lock set, side-effects are not permitted, and therefore the bit is not cleared. For more information, see *Permission summaries for memory-mapped and external debug interfaces* on page C6-45.
 - Bits [3:2] of DBGPRSR never read as 0b01.
-

The debug logic reset value for the Sticky Reset status bit is UNKNOWN.

Reset status, bit [2]

The meanings of the Reset status bit values are:

- 0** the non-debug logic of the processor is not currently held in reset state
- 1** the non-debug logic of the processor is currently held in reset state.

Note

Reset state is defined in *Reset state* on page C10-37.

Reads of the DBGPRSR made when the non-debug logic of the processor is in reset state return 1 for the Reset status.

Reads of the DBGPRSR made when the non-debug logic of the processor is not in reset state return 0 for the Reset status.

Sticky Power-down status, bit [1]

The meanings of the Sticky Power-down status bit values are:

- 0** the processor has not powered down since the last time this register was read
- 1** the processor has powered down since the last time this register was read.

This bit is cleared to 0 on a read of the DBGPRSR when the processor is in the powered-up state.

Note

If the implementation supports separate core and debug power domains, the Sticky Power-down status bit reflects the state of the core power domain. Powered-up and powered-down are defined in *Powered-up state* on page C10-37.

When the processor is in the powered-down state, the Sticky Power-down status bit is set to 1.

Reads of DBGPRSR made when the processor is in the powered down state return 1 for Sticky Power-down status and do not change the value of Sticky Power-down status.

Reads of DBGPRSR made when the processor is in the powered-up state return the current value of Sticky Power-down status, and then clear Sticky Power-down status to 0.

Note

- The value 0b00 for DBGPRSR[1:0], indicating certain of the debug registers cannot be accessed but have not lost their value, is not permitted in v7 Debug.
- On a read access, the Sticky Power-down status bit can be cleared only as a side effect of the read. When a read is made through the memory-mapped interface with the Software Lock set, side-effects are not permitted, and therefore the bit is not cleared. For more information, see *Permission summaries for memory-mapped and external debug interfaces* on page C6-45.

If this bit is set to 1, accesses to certain registers return an error response. For more information, see *Permissions in relation to power-down* on page C6-28.

The debug logic reset value for the Sticky Power-down status bit is UNKNOWN.

Power-up status, bit [0]

The meanings of the Power-up status bit values are:

- 0** The processor is powered-down. Certain debug registers cannot be accessed.
1 The processor is powered-up. All debug registers can be accessed.

Note

If the implementation supports separate core and debug power domains, the Power-up status bit reflects the state of the core power domain. Powered-up and powered-down are defined in *Powered-up state* on page C10-37.

The Power-up status bit reads the value of the **DBGPWRDUP** input on the external debug interface. For details of the **DBGPWRDUP** input see *DBGPWRDUP* on page AppxA-10.

Reads of DBGPRSR made when the processor is in the powered up state return 1 for Power-up status.

Reads of DBGPRSR made when the processor is in the powered down state return 0 for Power-up status.

For more information, see *Power domains and debug* on page C6-5.

Note

If only a single power-domain is implemented:

- bit [0] of the DBGPRSR is RAO
 - bit [1] of the DBGPRSR can be implemented as RAZ.
-

Reset state

In the reset scheme described in *Recommended reset scheme for v7 Debug* on page C6-16, the non-debug logic of the processor enters reset state following the assertion of at least one of:

- the internal or warm reset input, **nRESET**
- The power-up reset inputs, **nCOREPORESET** and **nSYSPORESET**.

All of these reset signals are asserted LOW.

Also, writing 1 to the Warm reset request bit of the DBGPRCR might cause the non-debug logic of the processor to enter reset state, see *Device Power-down and Reset Control Register (DBGPRCR), v7 Debug only* on page C10-31.

The processor stops executing instructions before it enters reset state.

The non-debug logic of the processor remains in reset state until:

- all of the reset signals **nRESET**, **nCOREPORESET**, and **nSYSPORESET**, are deasserted HIGH
- the Hold warm reset bit in the Device Power-down and Reset Control Register (DBGPRCR) is 0.

Note

One effect of asserting **nSYSPORESET** LOW is to place the debug logic into a reset state. In this state the DBGPRSR is not accessible.

The processor then resumes execution of instructions with the Reset exception.

Powered-up state

The processor is in the powered-up state when **DBGPWRDUP** is HIGH, and is in the powered-down state when **DBGPWRDUP** is LOW. Changing from powered-down state to powered-up state requires a reset of the processor.

If the implementation supports separate core and debug power domains, powered-up and powered-down state refer to the state of the core power domain.

Powered-up status is not affected by the reset state of the processor, whether that reset is:

- a power-up reset, **nCOREPORESET** or **nSYSPORESET**
- a warm reset, **nRESET**
- a reset occurring because the Hold non-debug logic reset bit in the Device Power-down and Reset Control Register (DBGPRCR) is set to 1.

For more information, see *Reset and power-down support* on page C6-4.

C10.3.6 Program Counter Sampling Register (DBGPCSR)

The Program Counter Sampling Register, DBGPCSR, enables a debugger to sample the Program Counter (PC).

DBGPCSR is defined only in the v7 Debug architecture. However, an ARMv6 implementation might implement DBGPCSR as part of the external debug interface.

In v7 Debug:

- It is IMPLEMENTATION DEFINED whether DBGPCSR is:
 - not implemented
 - implemented as debug register 33, at offset 0x084
 - implemented as debug register 40, at offset 0x0A0
 - implemented both as debug register 33 and as debug register 40.
- When DBGPCSR is implemented both as debug register 33 and as debug register 40, the two register numbers are aliases of each other.
- You can determine whether, or how, DBGPCSR is implemented as follows:
 - If DBGDIDR.PCSR_imp is 1, DBGPCSR is implemented as debug register 33. Otherwise, reads of register 33 return an UNKNOWN value.
 - If DBGDIDR.DEVID_imp is 1 and DBGDEVID.PCsample is non-zero, DBGPCSR is implemented as debug register 40. Otherwise, debug register 40 is reserved.

When implemented, the DBGPCSR is:

- a read-only register
- when the Security Extensions are implemented, a Common register.

Any read through the Extended CP14 interface of a CP14 register that maps to the DBGPCSR is UNDEFINED in User mode and UNPREDICTABLE in privileged modes.

ARM deprecates reading a PC sample through register 33 when the DBGPCSR is also implemented as register 40.

The format of the DBGPCSR is:



Program Counter Sample value, bits [31:2]

The sampled value of bits [31:2] of the PC. The sampled value is an instruction address plus an offset that depends on the processor instruction set state. See *Memory addresses* on page C3-23 for a definition of the *Instruction Virtual Address (IVA)* read through the DBGPCSR.

Meaning of PC Sample Value, bits [1:0]

The permitted values of this field are:

- 0b00** ((DBGPCSR[31:2] << 2) - 8) references an ARM state instruction
- 0bx1** ((DBGPCSR[31:1] << 1) - 4) references a Thumb or ThumbEE state instruction
- 0b10** IMPLEMENTATION DEFINED.

This field encodes the processor instruction set state, so that the profiling tool can calculate the true instruction address by subtracting the appropriate offset from the value sampled in bits [31:2] of the register.

For more information about Program Counter sampling, see *Program Counter sampling* on page C8-2.

C10.3.7 Context ID Sampling Register (DBGCIDSR)

The Context ID Sampling Register, DBGCIDSR, samples the CONTEXTIDR whenever the Program Counter Sampling Register, DBGPCSR, samples the Program Counter. This enables a debugger to associate a Program Counter sample with the process running on the processor.

DBGCIDSR is defined only in the v7 Debug architecture. However, an ARMv6 implementation might implement DBGCIDSR as part of the external debug interface.

In v7 Debug:

- It is IMPLEMENTATION DEFINED whether DBGCIDSR is implemented.
- If DBGDIDR.DEVID_imp is 1 and DBGDEVID.PCsample is 0b0010, DBGCIDSR is implemented as debug register 41. Otherwise, debug register 41 is reserved.

When implemented, the DBGCIDSR is:

- debug register 41, at offset 0x0A4
- a read-only register
- when the Security Extensions are implemented, a Common register.

Any read through the Extended CP14 interface of the CP14 register that maps to the DBGCIDSR is UNDEFINED in User mode and UNPREDICTABLE in privileged modes.

The format of the DBGCIDSR is:

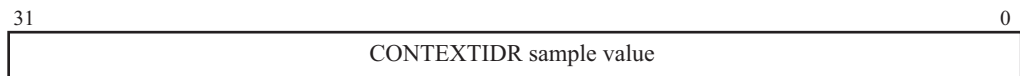
**CONTEXTIDR sample value, bits [31:0]**

The value of the Context ID Register, CONTEXTIDR, associated with the last PC sample read from DBGPCSR.

The core logic reset value of the DBGCIDSR is UNKNOWN.

For more information about Program Counter sampling, see *Program Counter sampling* on page C8-2.

C10.4 Instruction and data transfer registers

This section describes the registers that are used to transfer data between an external debugger and the ARM processor. It contains the following subsections:

- *Host to Target Data Transfer Register (DBGDTRRX)*
- *Target to Host Data Transfer Register (DBGDTRTX)* on page C10-43
- *Instruction Transfer Register (DBGITR)* on page C10-46.

The following registers and flags form the Debug Communications Channel:

- the DBGDTRRX Register, see *Host to Target Data Transfer Register (DBGDTRRX)*
- the DBGDTRTX Register, see *Target to Host Data Transfer Register (DBGDTRTX)* on page C10-43
- the RXfull, TXfull, TXfull_1, and RXfull_1 flags in the DBGDSCR, see:
 - the flag descriptions in *Debug Status and Control Register (DBGDSCR)* on page C10-10
 - *Access controls on the external view of the DCC registers and DBGITR, v7 Debug only* on page C10-21.

C10.4.1 Host to Target Data Transfer Register (DBGDTRRX)

The Host to Target Data Transfer Register, DBGDTRRX, is used by an external host to transfer data to the ARM processor. For example it is used by a debugger transferring commands and data to a debug target.

The DBGDTRRX Register is:

- Debug register 32, at offset 0x080.
- A component of the *Debug Communication Channel (DCC)*.
- Accessed through two views:
 - DBGDTRRXint, the internal view
 - DBGDTRRXext, the external view.

See *Internal and external views of the DBGDSCR and the DCC registers* on page C6-21 for definitions of the internal and external views.

- When the Security Extensions are implemented, a Common register.

The behavior of accesses to the DBGDTRRX Register depends on:

- which view is being accessed
- the values of flags in the DCC.

For more information, see *Access to the DBGDTRRX Register* on page C10-41.

The architectural status of the DBGDTRRX Register depends on the Debug architecture version:

- **ARMv6** DBGDTRRX was previously named rDTR. DBGDTRRXext is not defined in ARMv6. However, the DBGDTRRXext functionality must be implemented as part of the external debug interface.

v7 Debug The Extended CP14 interface instructions that access DBGDTRRText, if implemented, are UNPREDICTABLE in Debug state. For more information, see *Internal and external views of the DBGDSCR and the DCC registers* on page C6-21 and *Extended CP14 interface* on page C6-33.

The format of the DBGDTRRX Register is:

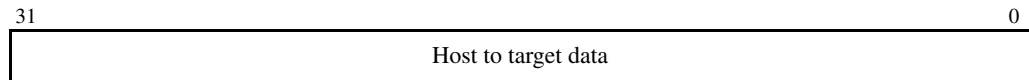

Host to target data, bits [31:0]

One word of data for transfer from the debug host to the debug target.

The debug logic reset value of the DBGDTRRX Register is UNKNOWN.

Access to the DBGDTRRX Register

The behavior on various accesses to the DBGDTRRX Register is described in the following tables:

- Table C10-4 shows the behavior of accesses to DBGDTRRXint
- Table C10-5 on page C10-42 shows the behavior of read accesses to DBGDTRRText
- Table C10-6 on page C10-42 shows the behavior of write accesses to DBGDTRRText.

To access the DBGDTRRXint Register you read the CP14 registers using either:

- an MRC instruction with <opc1> set to 0, <CRn> set to c0, <CRm> set to c5, and <opc2> set to 0
- an STC instruction with <CRd> set to c5.

Both instructions read only one word from the DBGDTRRXint Register. For example:

MRC p14,0,<Rd>,c0,c5,0 ; Read DBGDTRRXint Register

STC p14,c5,[<Rn>],#4 ; Read a word from the DBGDTRRXint Register and write it to memory

Table C10-4 Behavior of accesses to DBGDTRRXint

Access	RXfull	Action	New RXfull
Read	0	Returns an UNKNOWN value.	Unchanged
	1	Returns DBGDTRRX contents	0
Write	X	Not possible. There is no operation that writes to DBGDTRRXint	-

Note

- If the STC instruction that reads DBGDTRRXint aborts, the contents of DBGDTRRX and the value of the RXfull flag are UNKNOWN.
- The behavior on accesses to DBGDTRRXint does not depend on the value of RXfull_I,

- Accesses to DBGDTRRXint do not update the value of RXfull_I.

Accesses to DBGDTRRXext can be made through:

- the Extended CP14 interface, if implemented
- the memory-mapped interface, if implemented
- the external debug interface.

Table C10-5 Behavior of read accesses to DBGDTRRXext

Access mode ^a	Flag ^b	Flag value	Action	New RXfull	New RXfull_I
X	RXfull	0	Returns an UNKNOWN value	Unchanged	Unchanged
		1	Returns DBGDTRRX contents	Unchanged	Unchanged

- For more information, see *Access controls on the external view of the DCC registers and DBGITR*, v7 *Debug only* on page C10-21.
- This column indicates which of the RXfull, RXfull_I and InstrCompl flags are used to control the access. The access does not depend on the value of any other flags.

Table C10-6 Behavior of write accesses to DBGDTRRXext

Access mode ^a	Flag ^b	Flag value	Action	New RXfull	New RXfull_I
Non-blocking	RXfull_I	0	Writes to DBGDTRRX ^c	1 ^c	1 ^c
		1	Write is ignored.	Unchanged	Unchanged
Stall	RXfull	0	Writes to DBGDTRRX ^c	1 ^c	1 ^c
		1	Stalls ^c until (RXfull = 0)	-	-
Fast	InstrCompl	0	Stalls ^c until (InstrCompl = 1)	-	-
		1	Writes to DBGDTRRX ^{c, d} and issues the instruction from the DBGITR ^{c, e}	1 ^{c, d, e}	1 ^{c, d, e}

- For more information, see *Access controls on the external view of the DCC registers and DBGITR*, v7 *Debug only* on page C10-21.
- This column indicates which of the RXfull, RXfull_I and InstrCompl flags are used to control the access. The access does not depend on the value of any other flags.
- If the write is made through the memory-mapped interface and the Software Lock is set, the registers are read-only and accesses have no side-effects. This means that:
 DBGDTRRX, RXfull, RXfull_I, InstrCompl and InstrCompl_I are unchanged
 the access completes immediately
 in Fast mode no instruction is issued.
 For more information, see *Permission summaries for memory-mapped and external debug interfaces* on page C6-45.

- d. If RXfull is 1, the values of DBGDTRRX, RXfull, and RXfull_I become UNKNOWN.
 - e. If DBGDSCR.SDABORT_1, the Sticky Synchronous Data Abort bit, is set to 1, the instruction is not issued:
 - InstrCompl and InstrCompl_I are unchanged
 - the values of DBGDTRRX, RXfull and RXfull_I become UNKNOWN.
- For a description of the DBGDSCR.SDABORT_1 bit, see *Debug Status and Control Register (DBGDSCR)* on page C10-10.
- Otherwise, the instruction is issued and InstrCompl and InstrCompl_I are cleared to 0.

C10.4.2 Target to Host Data Transfer Register (DBGDTRTX)

The Target to Host Data Transfer Register, DBGDTRTX, is used by the ARM processor to transfer data to an external host. For example it is used by a debug target to transfer data to the debugger.

The DBGDTRTX Register is:

- Debug register 35, at offset 0x08C.
- A component of the *Debug Communication Channel (DCC)*.
- Accessed through two views:
 - DBGDTRTXint, the internal view
 - DBGDTRTXext, the external view.

See *Internal and external views of the DBGDSCR and the DCC registers* on page C6-21 for definitions of the internal and external views.

- When the Security Extensions are implemented, a Common register.

The behavior of accesses to the DBGDTRTX Register depends on:

- which view is being accessed
- the values of flags in the DCC.

For more information, see *Access to the DBGDTRTX Register* on page C10-44.

The architectural status of the DBGDTRTX Register depends on the Debug architecture version:

ARMv6 DBGDTRTX was previously named wDTR. DBGDTRTXext is not defined in ARMv6. However, the DBGDTRTXext functionality must be implemented as part of the external debug interface.

v7 Debug If implemented, the Extended CP14 interface instructions that access DBGDTRTXext are UNPREDICTABLE in Debug state. For more information, see *Internal and external views of the DBGDSCR and the DCC registers* on page C6-21 and *Extended CP14 interface* on page C6-33.

The format of the DBGDTRTX Register is:

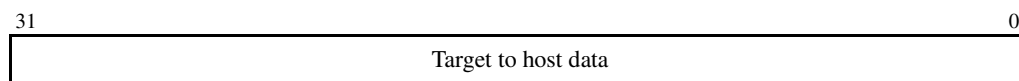

Target to host data, bits [31:0]

One word of data for transfer from the debug target to the debug host.

The debug logic reset value of the DBGDTRTX Register is UNKNOWN.

Access to the DBGDTRTX Register

The behavior on various accesses to the DBGDTRTX Register is described in the following tables:

- Table C10-7 shows the behavior of accesses to DBGDTRTXint
- Table C10-8 on page C10-45 shows the behavior of write accesses to DBGDTRTXext
- Table C10-9 on page C10-45 shows the behavior of read accesses to DBGDTRTXext.

To access the DBGDTRTXint Register you write the CP14 registers using either:

- an MCR instruction with <opc1> set to 0, <CRn> set to c0, <CRm> set to c5, and <opc2> set to 0
- an LDC instruction with <CRd> set to c5.

Both instructions write only one word to the DBGDTRTXint Register. For example:

```
MCR p14,0,<Rd>,c0,c5,0 ; Write DBGDTRTXint Register
```

```
LDC p14,c5,[<Rn>],#4 ; Read a word from memory and write it to the DBGDTRTXint Register
```

Table C10-7 Behavior of accesses to DBGDTRTXint

Access	TXfull	Action	New TXfull
Read	X	Not possible. There is no operation that reads from DBGDTRTXint.	-
Write	0	Writes value to DBGDTRTX.	1
	1	UNPREDICTABLE.	-

———— Note —————

- If the LDC instruction that writes to DBGDTRTXint aborts, the contents of DBGDTRTX and the value of the TXfull flag are UNKNOWN.
- The behavior on accesses to DBGDTRTXint does not depend on the value of TXfull_1
- Accesses to DBGDTRTXint do not update the value of TXfull_1.

Accesses to DBGDTRTXext can be made through:

- the Extended CP14 interface, if implemented
- the memory-mapped interface, if implemented
- the external debug interface.

Table C10-8 on page C10-45 shows the behavior of write accesses to DBGDTRTXext, and Table C10-9 on page C10-45 shows the behavior of read accesses to DBGDTRTXext.

Table C10-8 Behavior of write accesses to DBGDTRTXext

Access mode ^a	Flag ^b	Flag value	Action	New TXfull and TXfull_I
X	X	X	Updates DBGDTRTX value ^c	Unchanged

- For more information, see *Access controls on the external view of the DCC registers and DBGITR, v7 Debug only* on page C10-21.
- This column indicates which of the TXfull, TXfull_I and InstrCompl flags are used to control the access. The access does not depend on the value of any other flags.
- In the event of a race condition with writes to both DBGDTRTXint and DBGDTRTXext occurring, the result is UNPREDICTABLE. Writes to DBGDTRTXext must only be performed under controlled circumstances, for example when the processor is in Debug state.

Table C10-9 Behavior of read accesses to DBGDTRTXext

Access mode ^a	Flag ^b	Flag value	Action	New TXfull	New TXfull_I
Non-blocking	TXfull_I	0	Returns an UNKNOWN value.	Unchanged	Unchanged
		1	Returns DBGDTRTX contents	0 ^c	0 ^c
Stall	TXfull	0	Stalls ^c until (TXfull = 1)	-	-
		1	Returns DBGDTRTX contents	0 ^c	0 ^c
Fast	InstrCompl	0	Stalls ^c until (InstrCompl = 1)	-	-
		1	Returns DBGDTRTX contents ^d and issues the instruction in the DBGITR ^{c, e}	0 ^{c, d, e}	0 ^{c, d, e}

- For more information, see *Access controls on the external view of the DCC registers and DBGITR, v7 Debug only* on page C10-21.
- This column indicates which of the TXfull, TXfull_I and InstrCompl flags are used to control the access. The access does not depend on the value of any other flags.
- If the read is made through the memory-mapped interface and the Software Lock is set, the registers are read-only and accesses have no side effects. This means that:
 - TXfull, TXfull_I, InstrCompl, and InstrCompl_I remain unchanged
 - the access completes immediately
 - if TXfull==1, the access returns the contents of DBGDTRTX, otherwise it returns an UNKNOWN value
 - in Fast mode no instruction is issued.
 For more information, see *Permission summaries for memory-mapped and external debug interfaces* on page C6-45.
- If TXfull is 0, this returns an UNKNOWN value and the values of DBGDTRTX, TXfull and TXfull_I become UNKNOWN.
- The value returned is the value of DBGDTRTX before the instruction issued modifies the state of the processor. If DBGDSCR.SDABORT_I, the Sticky Synchronous Data Abort bit, is set to 1, the instruction is not issued, InstrCompl and InstrCompl_I remain unchanged, and the values of TXfull and TXfull_I become UNKNOWN. For a description of the DBGDSCR.SDABORT_I bit, see *Debug Status and Control Register (DBGDSCR)* on page C10-10. Otherwise, the instruction is issued and InstrCompl and InstrCompl_I are cleared to 0.

C10.4.3 Instruction Transfer Register (DBGITR)

The Instruction Transfer Register, DBGITR, enables external debugger to transfer ARM instructions to the processor for execution when the processor is in Debug state.

The DBGITR is:

- Debug register 33, at offset 0x084.
- A write-only register. However, accesses to the DBGITR also depend on:
 - the processor state
 - the values of the DBGDSCR.ExtDCCmode and DBGDSCR.ITRen fields, see *Debug Status and Control Register (DBGDSCR)* on page C10-10
 - the values of the DCC and InstrCompl_1 flags.
 For more information, see *Accesses to the DBGITR*.
- When the Security Extensions are implemented, a Common register.

The architectural status of the DBGITR depends on the Debug architecture version:

ARMv6 DBGITR is not defined in ARMv6. However, it might form part of the external debug interface.

v7 Debug Writes through the Extended CP14 interface of the CP14 register that maps to the DBGITR are UNDEFINED in User mode and UNPREDICTABLE in privileged modes.

The format of the DBGITR is:

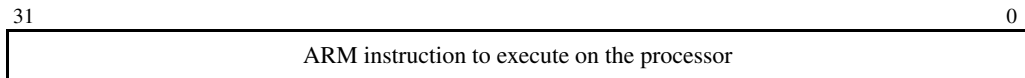

ARM instruction to execute on the processor, bits [31:0]

The 32-bit encoding of an ARM instruction to execute on the processor.

The debug logic reset value of the DBGITR is UNKNOWN.

Accesses to the DBGITR

Writes to the DBGITR are UNPREDICTABLE when:

- the processor is in Non-debug state
- DBGDSCR.ITRen is set to 0.

Table C10-10 on page C10-47 shows the behavior of writes to the DBGITR when in Debug state with the DBGDSCR.ITRen flag is set to 1.

Table C10-10 Behavior of write accesses to DBGITR

Access mode ^a	Flag ^b	Flag value	Action	New InstrCompl	New InstrCompl_I
Non-blocking	InstrCompl_I	0	Write is ignored	Unchanged	Unchanged
		1	Issue instruction ^c	0 ^c	0 ^c
Stall	InstrCompl	0	Stall until (InstrCompl = 0)	-	-
		1	Issue instruction ^c	0 ^c	0 ^c
Fast	Not applicable	-	Save instruction in DBGITR ^d	-	-

- a. For more information, see *Access controls on the external view of the DCC registers and DBGITR, v7 Debug only* on page C10-21.
- b. This column indicates which flag controls the access. The access does not depend on the value of any other flag.
- c. If DBGDSCR.SDABORT_I, the Sticky Synchronous Data Abort bit, is set to 1, the instruction is not issued and InstrCompl remains unchanged. For a description of the DBGDSCR.SDABORT_I bit, see *Debug Status and Control Register (DBGDSCR)* on page C10-10.
- d. The instruction is saved in the DBGITR and is issued on a read of DBGDTRTText or a write of DBGDTRRText. For more information, see *Access controls on the external view of the DCC registers and DBGITR, v7 Debug only* on page C10-21.

If the write is made through the memory-mapped interface and the Software Lock is set to 1, writes to the DBGITR are ignored and have no other side-effects. This means that:

- the DBGITR, and the InstrCompl and InstrCompl_I flags, remain unchanged
- no instruction is issued.

For more information, see *Permission summaries for memory-mapped and external debug interfaces* on page C6-45.

C10.5 Software debug event registers

This section contains the following subsections:

- *Breakpoint Value Registers (DBGBVR)*
- *Breakpoint Control Registers (DBGBCR)* on page C10-49
- *Watchpoint Value Registers (DBGWVR)* on page C10-60
- *Watchpoint Control Registers (DBGWCR)* on page C10-61
- *Vector Catch Register (DBGVCR)* on page C10-67.

In addition, when the OS Save and Restore mechanism is implemented, the Event Catch Register can be used to enable generation of a debug event when the OS Lock is unlocked, see *Event Catch Register (DBGECR)* on page C10-78.

C10.5.1 Breakpoint Value Registers (DBGBVR)

A Breakpoint Value Register, DBGBVR, holds a value for use in breakpoint matching. The value is either an *Instruction Virtual Address (IVA)* or a Context ID. Each DBGBVR is associated with a DBGBCR to form a *Breakpoint Register Pair (BRP)*. DBGBVR_n is associated with DBGBCR_n to form BRP_n, where n takes the values from 0 to 15. A debug event is generated when an instruction that matches the BRP is committed for execution. For more information, see *Breakpoint debug events* on page C3-5.

A breakpoint can be set on any one of:

- an IVA match or mismatch
- a Context ID match
- an IVA match or mismatch occurring with a Context ID match.

For the third case:

- two BRPs must be linked, see *Breakpoint Control Registers (DBGBCR)* on page C10-49.
- a debug event is generated when, on the same instruction, both:
 - the IVA matches or mismatches, as required
 - the Context ID matches.

See *Memory addresses* on page C3-23 for a definition of the IVA used to program a DBGBVR.

————— **Note** —————

Some BRPs might not support Context ID comparison. For more information, see the description of the DBGDIDR.CTX_CMPs field in *Debug ID Register (DBGDIDR)* on page C10-3.

The DBGBVRs are:

- debug registers 64-79, at offsets 0x100-0x13C
- read/write registers
- when the Security Extensions are implemented, Common registers.

When used for IVA comparison the format of a DBGBVR is:

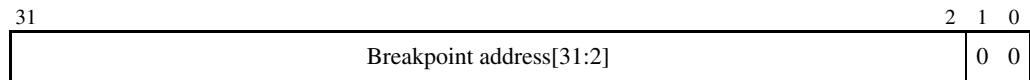

When used for Context ID comparison the format of a DBGBVR is:

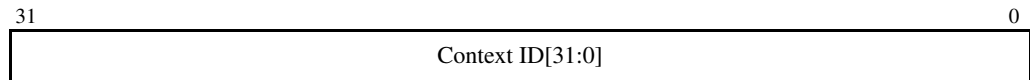

Bits [31:2] Bits [31:2] of the value for comparison. Either IVA[31:2] or ContextID[31:2].

Bits [1:0], when register used for IVA comparison

Must be written as 0b00, otherwise the generation of Breakpoint debug events is UNPREDICTABLE

Bits [1:0], when register used for Context ID comparison

Bits [1:0] of the value for comparison, ContextID[1:0].

If the BRP does not support Context ID comparison then bits [1:0] are UNK/SBZP.

The debug logic reset values of all bits of a DBGBVR are UNKNOWN.

C10.5.2 Breakpoint Control Registers (DBGBCR)

A Breakpoint Control Register, DBGBCR, holds control information for a breakpoint. Each DBGBCR is associated with a DBGBVR to form a *Breakpoint Register Pair* (BRP). For more information about BRPs and the possible breakpoints, see *Breakpoint Value Registers (DBGBVR)* on page C10-48.

The DBGBCRs are:

- debug registers 80-95, at offsets 0x140-0x17C
- read/write registers
- when the Security Extensions are implemented, Common registers.

The format of a DBGBCR, in v7 Debug, is:

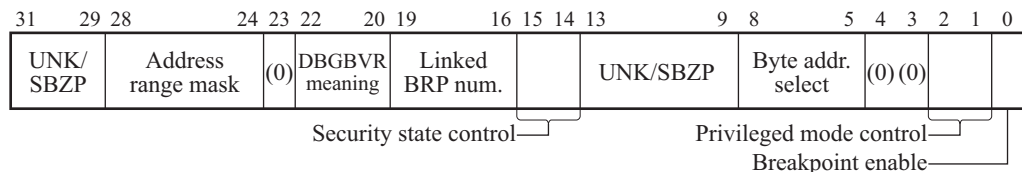

See the bit descriptions for the differences in other Debug architecture versions.

Bits [31:29,23,13:9,4:3]

Reserved, UNK/SBZP.

Address range mask, bits [28:24], v7 Debug

In v7 Debug, whether address range masking is supported is IMPLEMENTATION DEFINED. If it is not supported these bits are RAZ/WI.

If address range masking is supported, this field can be used to break on a range of addresses by masking lower order address bits out of the breakpoint comparison. The value of this field is the number of low order bits of the address that are masked off, except that values of 1 and 2 are reserved. Therefore, the meaning of Breakpoint address range mask values are:

0b00000	No mask
0b00001	Reserved
0b00010	Reserved
0b00011	0x00000007 mask for instruction address, three bits masked
0b00100	0x0000000F mask for instruction address, four bits masked
0b00101	0x0000001F mask for instruction address, five bits masked
.	.
.	.
.	.
0b11111	0x7FFFFFFF mask for instruction address, 31 bits masked.

This field must be programmed to 0b00000 if either:

- this BRP is programmed for Context ID comparison
- the Byte address select field is programmed to a value other than 0b1111.

If this is not done, the generation of Breakpoint debug events is UNPREDICTABLE.

If this field is not zero, the DBGBVR bits that are not included in the comparison must be zero, otherwise the generation of Breakpoint debug events is UNPREDICTABLE.

For more information about the use of this field see *Breakpoint address range masking behavior, v7 Debug* on page C3-9.

Bits [28:24], v6 Debug and v6.1 Debug

Reserved, UNK/SBZP.

DBGBVR meaning, bits [22:20]

This field controls the behavior of Breakpoint debug event generation. This includes the meaning of the value held in the associated DBGBVR, whether it is an IVA or a Context ID. Each bit of this field has particular significance, and there can be restrictions on the values of bits [22:21]:

Bit [22], Match or mismatch

This bit is set to 1 for a mismatch comparison.

This bit is not supported and is UNK/SBZP in v6 Debug.

For more information about IVA mismatching see *Additional considerations for IVA mismatch breakpoints* on page C3-13.

The Debug architecture does not support Context ID mismatch comparisons.

Bit [21], IVA or Context ID comparison

This bit is set to 1 for a Context ID comparison.

This bit is UNK/SBZP for BRPs that do not support Context ID comparison. In this case field values of 0b010 and 0b011 are not supported.

Bit [20], Unlinked or Linked comparison

This bit is set to 1 if this BRP is linked to another BRP to set a breakpoint that requires both IVA and Context ID comparison.

For more information about IVA matching and mismatching see:

- *Byte address selection behavior on IVA match or mismatch* on page C10-55
- *Breakpoint address range masking behavior, v7 Debug* on page C3-9
- *IVA comparisons and instruction length* on page C3-10.

The possible values of the *DBGBVR meaning* field are:

0b000 Unlinked Instruction Virtual Address match

Compare:

- the byte address select bits, bits [8:5], and the associated `DBGBVR[31:2]`, against the IVA of the instruction
- the security state control and privileged mode control bits, bits [15:14,2:1], against the state of the processor.

Generate a Breakpoint debug event on a joint IVA match and state match.

`DBGBCR[19:16]` must be programmed to 0b0000, otherwise the generation of Breakpoint debug events is UNPREDICTABLE.

0b001 Linked Instruction Virtual Address match

Compare:

- the byte address select bits, bits [8:5], and the associated `DBGBVR[31:2]`, against the IVA of the instruction
- the security state control and privileged mode control bits, bits [15:14,2:1], against the state of the processor.

This BRP is linked with the BRP indicated by `DBGBCR[19:16]`. Generate a Breakpoint debug event on a joint IVA match, Context ID match and state match. For more information, see *Linked comparisons* on page C10-59.

0b010 Unlinked Context ID match

Compare:

- the associated `DBGBVR[31:0]` against the Context ID in the `CONTEXTIDR`
- the security state control and privileged mode control bits, bits [15:14,2:1], against the state of the processor.

This BRP is not linked with any other one. Generate a Breakpoint debug event on a joint Context ID match and state match.

DBGBCR[8:5] must be programmed to 0b1111 and DBGBCR[19:16] must be programmed to 0b0000, otherwise the generation of Breakpoint debug events is UNPREDICTABLE.

———— **Note** ————

See *Unpredictable behavior on Software debug events* on page C3-24 for additional restrictions for this type of breakpoint when using Monitor debug-mode.

0b011 Linked Context ID match

Compare the associated DBGBVR[31:0] against the Context ID in the CONTEXTIDR.

At least one other BRP or WRP is linked with this BRP. Generate a Breakpoint or Watchpoint debug event jointly on:

- the IVA match or mismatch or DVA match, defined by the linked BRP or WRP
- the Context ID match defined by this BRP.

If no BRP or WRP of the correct type is linked to this BRP, no Breakpoint or Watchpoint debug events are generated for this BRP.

For more information about the programming required for a Linked Context ID match see *Linked comparisons* on page C10-59.

0b100 Unlinked Instruction Virtual Address mismatch

Compare:

- the byte address select bits, bits [8:5], and the associated DBGBVR[31:2], against the IVA of the instruction
- the security state control and privileged mode control bits, bits [15:14,2:1], against the state of the processor.

Generate a Breakpoint debug event on a joint IVA mismatch (IVA not equal) and state match.

DBGBCR[19:16] must be programmed to 0b0000, otherwise the generation of Breakpoint debug events is UNPREDICTABLE.

———— **Note** ————

- Unlinked IVA mismatch is not supported in v6 Debug.
 - See *Unpredictable behavior on Software debug events* on page C3-24 for additional restrictions for this type of breakpoint when using Monitor debug-mode.
-

0b101 Linked Instruction Virtual Address mismatch

Compare:

- the byte address select bits, bits [8:5], and the associated DBGVR[31:2], against the IVA of the instruction
- the security state control and privileged mode control bits, bits [15:14,2:1], against the state of the processor.

This BRP is linked with the BRP indicated by DBGBCR[19:16]. Generate a Breakpoint debug event on a joint IVA mismatch (IVA not equal), state match and Context ID match. For more information, see *Linked comparisons* on page C10-59.

Note

- Linked IVA mismatch is not supported in v6 Debug.
 - See *Unpredictable behavior on Software debug events* on page C3-24 for additional restrictions for this type of breakpoint when using Monitor debug-mode.
-

0b11x Reserved

Generation of Breakpoint debug events is UNPREDICTABLE.

Summary of breakpoint generation options on page C10-58 shows what comparisons are made for each permitted value of this field.

Linked BRP number, bits [19:16]

If this BRP is programmed for Linked IVA match or mismatch then this field must be programmed with the number of the BRP that holds the Context ID to be used for the combined IVA and Context ID comparison, otherwise, this field must be programmed to 0b0000.

If this field is programmed with a value other than zero or the number of a BRP that supports Context ID comparison then reading this register returns an UNKNOWN value for this field.

The generation of Breakpoint debug events is UNPREDICTABLE if either:

- this BRP is not programmed for Linked IVA match or mismatch and this field is not programmed to 0b0000
- this BRP is programmed for Linked IVA match or mismatch and the BRP indicated by this field does not support Context ID comparison or is not programmed for Linked Context ID match.

See also *Generation of debug events* on page C3-40.

Security state control, bits [15:14], when the Security Extensions are implemented**Note**

The Security Extensions cannot be implemented with v6 Debug.

When a processor implements the Security Extensions, these bits enable the breakpoint to be conditional on the security state of the processor:

- 0b00** breakpoint generated on match in both Non-secure state and Secure state
- 0b01** breakpoint generated on match only in Non-secure state
- 0b10** breakpoint generated on match only in Secure state
- 0b11** Reserved.

This field must be programmed to 0b00 if the *DBGBVR meaning* field, bits [22:20], is programmed for Linked Context ID match.

For more information about breakpoint matching when this field is set to a value other than 0b00, see *About security state control* on page C10-66.

See also *Generation of debug events* on page C3-40.

Bits [15:14], when the Security Extensions are not implemented

Reserved, UNK/SBZP.

Byte address select, bits [8:5]

This field enables match or mismatch comparisons on only certain bytes of the word address held in the *DBGBVR*. The operation of this field depends also on:

- the *DBGBVR meaning* field being programmed for IVA match or mismatch
- in v7 Debug, the Address range mask field being programmed to 0b00000, no mask
- the instruction set state of the processor, indicated by the CPSR.J and CPSR.T bits.

For details of the use of this field see *Byte address selection behavior on IVA match or mismatch* on page C10-55.

This field must be programmed to 0b1111 if either:

- the *DBGBVR meaning* field, bits [22:20], is programmed for Linked or Unlinked Context ID match
- in v7 Debug, the Address range mask field, bits [28:24], is programmed to a value other than 0b00000.

If this is not done, the generation of Breakpoint debug events is UNPREDICTABLE.

Privileged mode control, bits [2:1]

This field enables breakpoint matching conditional on the mode of the processor. Possible values of this field are:

- 0b00** Match any of User, System and Supervisor modes.
This value is supported in v7 Debug only.
- 0b01** Match in any privileged mode.
- 0b10** Match in User mode only.

0b11 Match in any mode.

This field must be programmed to 0b11 if the DBGBVR meaning field, bits [22:20], is programmed for Linked Context ID match.

Breakpoint enable, bit [0]

This bit enables the BRP. The meaning of this bit is:

0 Breakpoint disabled
1 Breakpoint enabled.

A BRP never generates Breakpoint debug events when its DBGBCR is disabled.

The debug logic reset values of all bits of the DBGBCR are UNKNOWN.

Note

- In v6 Debug and v6.1 Debug, the Breakpoint enable bit of the DBGBCR is set to 0 on a debug logic reset, disabling the breakpoint.
 - In v7 Debug, a debugger must ensure that DBGBCR[0] has a defined state before it programs DBGDSCR[15:14] to enable debug.
-

Byte address selection behavior on IVA match or mismatch

The DBGBVR is programmed with a word address. If you have programmed the BRP for Linked or Unlinked IVA match or mismatch, you can program the *Byte address select* field, DBGBCR[8:5], so that the breakpoint hits only if certain byte addresses are accessed. The exact interpretation depends on the processor instruction set state, as indicated by the CPSR.J and CPSR.T bits, and on the bottom two bits of the IVA. Table C10-11 on page C10-56 shows the operation of byte address masking using the DBGBCR[8:5] field.

Note

In the following cases, you must program DBGBCR[8:5] to 0b1111:

- if you program the BRP for Linked or Unlinked Context ID match
 - in v7 Debug, if you program the BRP for linked or unlinked IVA match or mismatch with a nonzero Address range mask.
-

Table C10-11 Effect of byte address selection on Breakpoint generation

Instruction set ^a	Instruction address ^b	DBGBCR[8:5]	This BRP programmed for:		
			IVA match	IVA mismatch	
Any	Any address	0000	Miss	Hit	
ARM	DBGBVR<31:2>:'00'	1111	Hit	Miss	
		0000	Miss	Hit	
		Any other value	UNPREDICTABLE		
	Any other address	xxxx	Miss	Hit	
Thumb or ThumbEE	DBGBVR<31:2>:'00'	xx11	Hit	Miss	
		xx10	UNPREDICTABLE		
		xx01	UNPREDICTABLE		
		xx00	Miss	Hit	
	DBGBVR<31:2>:'10'	11xx	Hit	Miss	
		10xx	UNPREDICTABLE		
		01xx	UNPREDICTABLE		
		00xx	Miss	Hit	
	Any other address	xxxx	Miss	Hit	
	Jazelle	DBGBVR<31:2>:'00'	xxx1	Hit	Miss
			xxx0	Miss	Hit
		DBGBVR<31:2>:'01'	xx1x	Hit	Miss
xx0x			Miss	Hit	
DBGBVR<31:2>:'10'		x1xx	Hit	Miss	
		x0xx	Miss	Hit	

Table C10-11 Effect of byte address selection on Breakpoint generation (continued)

Instruction set ^a	Instruction address ^b	DBGBCR[8:5]	This BRP programmed for:	
			IVA match	IVA mismatch
Jazelle	DBGVVR<31:2>: '11'	1xxx	Hit	Miss
		0xxx	Miss	Hit
	Any other address	xxxx	Miss	Hit

a. As indicated by the CPSR.J and CPSR.T bits.

b. For more information see the Note that follows this table.

In a processor with a trivial implementation of the Jazelle extension, generation of Breakpoint debug events is UNPREDICTABLE, and the value of a subsequent read from DBGBCR[8:5] is UNKNOWN, if the value written to DBGBCR[8:5] has either DBGBCR[8] != DBGBCR[7], or DBGBCR[6] != DBGBCR[5]. For a description of the trivial implementation of the Jazelle extension see *Trivial implementation of the Jazelle extension* on page B1-81.

————— Note —————

- In Table C10-11 on page C10-56, the instruction address value is the address of the first unit of the instruction. For more information, including what happens when the BRP hits the address of a unit of the instruction other than the first unit, see *IVA comparisons and instruction length* on page C3-10.
- In the ARMv7-R profile, the value of the Instruction Endianness bit, SCTL.R.IE, does not affect the generation of breakpoint debug events. For more information about instruction endianness, see *Instruction endianness* on page A3-8.

For examples of how to program a BRP using byte address selection see *IVA comparison programming examples* on page C3-12.

Summary of breakpoint generation options

Table C10-12 shows which values are compared and which are not for each type of BRP. Table entries in **bold typewriter** indicate an element of the comparison that is made. Reading across the *Comparison* columns for a row of the table gives the comparison to be made. For example, for the Linked IVA mismatch (0b001), the comparison is:

Not (**Equal**s[IVA] AND **Set**[Byte lanes]) AND **Match**[State] AND **Link**[Linked Breakpoint]

Breakpoint generation is described by the BRPMatch() pseudocode function, see *Breakpoints and Vector Catches* on page C3-28.

Table C10-12 DBGBVR meaning bits summary

BRP type bits ^a	Description	Comparison				
		IVA ^b	Byte lanes ^c	Context ID ^d	State ^e	Linked
000	IVA match	Equal s	AND Set		AND Match	
001	Linked IVA match ^f	Equal s	AND Set		AND Match	AND Link
010	Context ID ^{g, h}			Equal s	AND Match	
011	Linked Context ID ^{g, i}			Equal s		AND Link
100	IVA mismatch ^h	Not (Equal s	AND Set)		AND Match	
101	Linked IVA mismatch ^{f, h}	Not (Equal s	AND Set)		AND Match	AND Link
11x	Reserved	-	-	-	-	-

- a. The *DBGBVR meaning* field, DBGBCR[22:20].
- b. Matching IVA[31:2] against DBGBVR[31:2]. If the breakpoint Address range mask bits [28:24] are set to a value other than 0b00000, a masked comparison is used. See *Breakpoint address range masking behavior, v7 Debug* on page C3-9.
- c. IVA byte lanes. DBGBCR[8:5] indicate the byte lanes to be compared, see *Byte address selection behavior on IVA match or mismatch* on page C10-55.
- d. Matching CONTEXTIDR[31:0] against DBGBVR[31:0].
- e. Processor state comparison made, according to value of DBGBCR[15:14, 2:1], see *Breakpoint Control Registers (DBGBCR)* on page C10-49.
- f. The Context ID is compared against the value of the linked breakpoint and a breakpoint event is only generated when both conditions match. If the linked breakpoint is not capable of Context ID comparison, or is not configured for Linked Context ID match, the generation of Breakpoint debug events is UNPREDICTABLE.
- g. DBGBCR[8:5] for this BRP must be programmed to 0b1111; otherwise the generation of Breakpoint debug events is UNPREDICTABLE.
- h. When Monitor debug-mode is selected, take care when programming DBGBCR[2:1], Privileged access control. See *Unpredictable behavior on Software debug events* on page C3-24 for more information.
- i. See *Linked comparisons* on page C10-59.

Linked comparisons

For linked comparisons, a comparison includes a Context ID match, defined by a BRP, with one or more address comparisons defined by other BRPs or WRPs linked to the Context ID match:

- Zero or more other BRPs, each programmed to define a linked IVA match.
- Zero or more other BRPs, each programmed to define a linked IVA mismatch.

———— **Note** —————

Linked IVA mismatch is not supported in v6 Debug.

- Zero or more WRPs, each programmed to define a linked DVA match.

The Breakpoint or Watchpoint debug event is generated only if both:

- the Context ID match is true
- the IVA match or mismatch, or the DVA match, is true.

In this description:

- BRPm is used to define the Context ID match.
- BRPn is configured to define a linked IVA match or mismatch, and is linked to BRPm
- WRPn is configured to define a linked DVA match, and is linked to BRPm

If there are no BRPs and no WRPs linked to BRPm then BRPm cannot generate any debug events. The rest of this description assumes at least one BRP or WRP is linked to BRPm.

To configure BRPm to define the Context ID match part of the linked Context ID matches:

- program DBGBVRm[31:0] with the Context ID to be matched
- program DBGBCRm[22:20] to 0b011, linked Context ID comparison
- generation of the debug events is UNPREDICTABLE unless all of these conditions are met:
 - DBGBCRm[19:16] is programmed to 0b0000
 - DBGBCRm[15:14] is programmed to 0b00
 - DBGBCRm[8:5] is programmed to 0b1111
 - DBGBCRm[2:1] is programmed to 0b11.

To configure BRPn to define the IVA match or mismatch part of a linked Context ID match:

- program DBGBVRn[31:2] with the address for comparison, and DBGBVRn[1:0] to b00
- program DBGBCRn[22:20] to either:
 - 0b001, for linked IVA match
 - 0b101, for linked IVA mismatch, in v6.1 Debug or v7 Debug
- program DBGBCRn[19:16] to m, the number of the BRP that defines the Context ID match
- if required, program DBGBCRn[15:14,2:1] to include the state of the processor in the comparison.

To configure WRPn to define the DVA match part of a linked Context ID match:

- program DBGWVRn[31:2] with the address for comparison, and DBGWVRn[1:0] to b00
- program DBGWCRn[20] to 1, to enable linking
- program DBGWCRn[19:16] to m, the number of the BRP that defines the Context ID match
- if required, program DBGWCRn[15:14,2:1] to include the state of the processor in the comparison.

The generation of Breakpoint debug events is UNPREDICTABLE if:

- BRPn is linked to BRPm but is not configured for Linked IVA match or Linked IVA mismatch
- WRPn is linked to BRPm but is not configured to enable linking
- WRPn or BRPn is linked to BRPm and either:
 - BRPm does not support Linked Context ID matching
 - BRPm is not configured for Linked Context ID matching.

C10.5.3 Watchpoint Value Registers (DBGWVR)

A Watchpoint Value Register, DBGWVR, holds a *Data Virtual Address* (DVA) value for use in watchpoint matching. Each DBGWVR is associated with a DBGWCR to form a *Watchpoint Register Pair* (WRP). DBGWVRn is associated with DBGWCRn to form WRPn, where n takes the values from 0 to 15. A debug event is generated when the WRP is matched. For more information, see *Watchpoint debug events* on page C3-15.

A watchpoint can be set on either:

- a DVA match
- a DVA match occurring with a Context ID match.

For the second case:

- a WRP and a BRP with Context ID comparison capability have to be linked, see *Watchpoint Control Registers (DBGWCR)* on page C10-61 and *Linked comparisons* on page C10-59.
- a debug event is generated when, on the same instruction, both:
 - the DVA matches
 - the Context ID matches.

See *Memory addresses* on page C3-23 for a definition of the DVA used to program a DBGWVR.

The DBGWVRs are:

- debug registers 96-111, at offsets 0x180-0x1BC
- read/write registers
- when the Security Extensions are implemented, Common registers.

The format of a DBGWVR is:

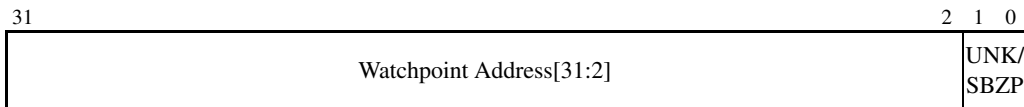

Bits [31:2] Bits [31:2] of the value for comparison, DVA[31:2].

Bits [1:0] Reserved. UNK/SBZP.

The debug logic reset value of a DBGWVR is UNKNOWN.

C10.5.4 Watchpoint Control Registers (DBGWCR)

A Watchpoint Control Register, DBGWCR, holds control information for a watchpoint. Each DBGWCR is associated with a DBGWVR to form a *Watchpoint Register Pair* (WRP). For more information about WRPs and the possible watchpoints see *Watchpoint Value Registers (DBGWVR)* on page C10-60.

The DBGWCRs are:

- debug registers 112-127, at offsets 0x1C0-0x1FC
- read/write registers
- when the Security Extensions are implemented, Common registers.

The format of a DBGWCR, in v7 Debug, is:

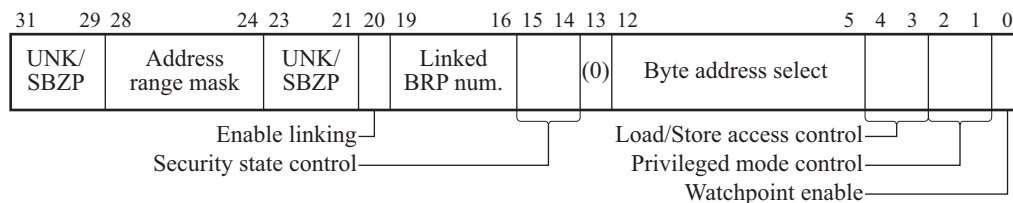

See the bit descriptions for the differences in other Debug architecture versions.

Bits [31:29, 23:21,13]

Reserved, UNK/SBZP.

Address range mask, bits [28:24], v7 Debug

In v7 Debug, support for watchpoint address range masking is optional. If it is not supported these bits are RAZ/WI.

If watchpoint address range masking is supported, this field can be used to watch a range of addresses by masking lower order address bits out of the watchpoint comparison. The value of this field is the number of low order bits of the address that are masked off, except that values of 1 and 2 are reserved. Therefore, the meaning of Watchpoint Address range mask values are:

0b00000	No mask
0b00001	Reserved
0b00010	Reserved
0b00011	0x00000007 mask for data address, three bits masked
0b00100	0x0000000F mask for data address, four bits masked
0b00101	0x0000001F mask for data address, five bits masked
.	.
.	.
.	.
0b11111	0x7FFFFFFF mask for data address, 31 bits masked.

This field must be programmed to 0b00000 if either:

- DBGWCR[12:5] != 0b11111111, if an 8-bit Byte address select field is implemented
- DBGWCR[8:5] != 0b1111, if a 4-bit Byte address select field is implemented.

If this is not done, the generation of Watchpoint debug events is UNPREDICTABLE.

If this field is not zero, the DBGWVR bits that are not included in the comparison must be zero, otherwise the generation of Watchpoint debug events is UNPREDICTABLE.

To watch for a write to any byte in an doubleword-aligned object of size 8 bytes, ARM recommends that debuggers set DBGWCR[28:24] = 0x7 and DBGWCR[12:5] = 0b11111111. This setting is compatible with both implementations with an 8-bit Byte address select field and implementations with a 4-bit Byte address select field, because implementations with a 4-bit Byte address select field ignore writes to DBGWCR[12:9].

Bits [28:24], v6 Debug and v6.1 Debug

Reserved, UNK/SBZP.

Enable linking, bit [20]

This bit is set to 1 if this WRP is linked to a BRP to set a linked watchpoint that requires both DVA and Context ID comparison. The possible values of this bit are

- | | |
|----------|------------------|
| 0 | linking disabled |
| 1 | linking enabled. |

When this bit is set to 1 the Linked BRP number field indicates the BRP to which this WRP is linked. For more information, see *Linked comparisons* on page C10-59.

Linked BRP number, bits [19:16]

If this WRP is programmed with linking enabled then this field must be programmed with the number of the BRP that holds the Context ID to be used for the combined DVA and Context ID comparison, otherwise, this field must be programmed to 0b0000.

If this field is programmed with a value other than zero or the number of a BRP that supports Context ID comparison then reading this register returns an UNKNOWN value for this field.

The generation of Watchpoint debug events is UNPREDICTABLE if either:

- this WRP does not have linking enabled and this field is not programmed to 0b0000
- this WRP has linking enabled and the BRP indicated by this field does not support Context ID comparison or is not programmed for Linked Context ID match.

Security state control, bits [15:14], when the Security Extensions are implemented

————— **Note** —————

The Security Extensions cannot be implemented with v6 Debug.

When a processor implements the Security Extensions, these bits enable the [breakpoint](#) to be conditional on the security state of the processor:

- | | |
|-------------|---|
| 0b00 | watchpoint generated on match in both Non-secure state and Secure state |
|-------------|---|

- 0b01** watchpoint generated on match only in Non-secure state
- 0b10** watchpoint generated on match only in Secure state
- 0b11** Reserved.

For more information about watchpoint matching when this field is set to a value other than 0b00, see *About security state control* on page C10-66.

Bits [15:14], when the Security Extensions are not implemented

Reserved, UNK/SBZP.

Bit [12:9], v6 Debug and v6.1 Debug

Reserved, UNK/SBZP.

Byte address select, bits [12:5] or bits [8:5]

The width of this field can depend on the ARM Debug architecture version:

v6 Debug and v6.1 Debug

The Byte address select field is always 4 bits, DBGWCR[8:5]

v7 Debug

It is IMPLEMENTATION DEFINED whether a 4-bit or an 8-bit Byte address select field is implemented:

- an 8-bit Byte address select field is DBGWCR[12:5]
- if a 4-bit Byte address select field is implemented then the Byte address select field is DBGWCR[8:5] and DBGWCR[12:9] is RAZ/WI.

DBGWVRs are programmed with word-aligned addresses. This field enables the watchpoint to hits only if certain byte addresses are accessed. The watchpoint hits if an access hits any byte being watched, even if:

- the access size is larger than the size of the region being watched
- the access is unaligned, and the base address of the access is not in the same word of memory as the address in the DBGWVR.

For details of the use of this field see *Byte address masking behavior on DVA match* on page C10-65.

If the Address range mask field is implemented and programmed to a value other than 0b00000, no mask, then this field must be programmed to:

- 0b1111, if a 4-bit Byte address select field is implemented.
- 0b11111111, an 8-bit Byte address select field is implemented.

If this is not done, the generation of Watchpoint debug events is UNPREDICTABLE.

Load/store access control, bits [4:3]

This field enables watchpoint matching conditional on the type of access being made. Possible values of this field are:

- 0b00** Reserved.
- 0b01** Match on any load, Load-Exclusive, or swap.

0b10 Match on any store, Store-Exclusive or swap.

0b11 Match on any either type of access.

If an implementation supports watchpoint generation by:

- a memory hint instruction, then that instruction is treated as generating a load access
- a cache maintenance operation, then that operation is treated as generating a store access.

Privileged mode control, bits [2:1]

This field enables watchpoint matching conditional on the mode of the processor. Possible values of this field are:

0b00 Reserved.

0b01 Match privileged accesses.

0b10 Match unprivileged accesses.

0b11 Match all accesses.

Note

- For all cases the match refers to the privilege of the access, not the mode of the processor. For example, if the watchpoint is configured to match privileged accesses only (0b01), and the processor executes an LDRT instruction in a privileged mode, the watchpoint does not match.
- Permitted values of this field are not identical to those for the DBGBCR. In the DBGBCR only, in v7 Debug, the value 0b00 is permitted.

Watchpoint enable, bit [0]

This bit enables the WRP. The meaning of this bit is:

0 Watchpoint disabled

1 Watchpoint enabled.

A WRP never generates Watchpoint debug events when its DBGWCR is disabled.

The debug logic reset values of all bits of the DBGWCR is UNKNOWN.

Note

- In v6 Debug and v6.1 Debug, the Watchpoint enable bit of the DBGWCR is set to 0 on a debug logic reset, disabling the watchpoint.
- In v7 Debug, a debugger must ensure that DBGWCR[0] has a defined state before it programs DBGDSCR[15:14] to enable debug.

Byte address masking behavior on DVA match

For each WRP, the DBGWVR is programmed with a word-aligned address. The Byte address select bits of the DBGWCR can be programmed so that the watchpoint hits if only certain bits of the watched address are accessed:

- in all implementations, DBGWCR[8:5] can be programmed to enable the watchpoint to hit on any access to one or more of the bytes of the word addressed by the associated DBGWVR
- in a v7 Debug implementation that supports an 8-bit Byte address select field, DBGWCR[12:5] can be programmed to enable the watchpoint to hit on any access to one or more of the bytes of the doubleword addressed by the associated DBGWVR.

In all cases, a Watchpoint debug event is generated if an access hits any byte being watched, even if:

- the access size is larger than the size of the region being watched
- the access is unaligned, and the base address of the access is not in the word of memory addressed by DBGWVR.

Table C10-13 and Table C10-14 on page C10-66 show the meaning of the Byte address select values. Table C10-13 shows the values that can be programmed in any implementation.

Table C10-13 Byte address select values, word-aligned address

DBGWCR[12:5] value	Description
00000000	Watchpoint never hits
xxxxxxx1	Watchpoint hits if byte at address DBGWVR<31:2>:'00' is accessed
xxxxxx1x	Watchpoint hits if byte at address DBGWVR<31:2>:'01' is accessed
xxxxx1xx	Watchpoint hits if byte at address DBGWVR<31:2>:'10' is accessed
xxxx1xxx	Watchpoint hits if byte at address DBGWVR<31:2>:'11' is accessed

In v6 Debug and v6.1 Debug only a 4-bit Byte address select field is implemented and DBGWCR[12:9] is UNK/SBZP.

In v7 Debug, it is IMPLEMENTATION DEFINED whether an implementation supports a 4-bit or an 8-bit Byte address select field:

- If the processor implements a 4-bit Byte address select field, then DBGWCR[12:9] is RAZ/WI.
- If the processor implements an 8-bit Byte address select field, then DBGWCR[12:9] can also be programmed, and, for a given watchpoint register pair:
 - DBGWVR can be programmed with a doubleword-aligned address, with DBGWVR[2] = 0. In this case DBGWCR[12:5] can be programmed to match any of the 8 bytes in that doubleword value.

- If DBGWVR[2] == 1, indicating a word-aligned address that is not doubleword-aligned, then DBGWCR[12:9] must be programmed with zero.
If DBGWVR[2] == 1 and DBGWCR[12:9] != 0b0000, Watchpoint debug event generation is UNPREDICTABLE.

Table C10-14 shows the additional Byte address select field encodings that are available, when DBGWVR[2] == 0, on an implementation that supports an 8-bit Byte address select field.

Table C10-14 Additional Byte address select values, doubleword-aligned address

DBGWCR[12:5] value	Description
xxx1xxxx	Watchpoint hits if byte at address DBGWVR<31:3>:'100' is accessed
xx1xxxxx	Watchpoint hits if byte at address DBGWVR<31:3>:'101' is accessed
x1xxxxxx	Watchpoint hits if byte at address DBGWVR<31:3>:'110' is accessed
1xxxxxxx	Watchpoint hits if byte at address DBGWVR<31:3>:'111' is accessed

The same programming model can be used on implementations that support:

- an 8-bit Byte address select field, DBGWCR[12:5]
- a 4-bit Byte address select field, DBGWCR[8:5].

This is because, on an implementation that supports only a 4-bit Byte address select field, writes to DBGWCR[12:9] are ignored.

Note

In ARMv6, when using the optional legacy BE-32 endianness model, the values of DBGWCR[8:5] shown in Table C10-13 on page C10-65 have different meanings. For more information see *BE-32 DBGWCR Byte address select values* on page AppxG-7.

About security state control

When the Security Extensions are implemented and the security state control bits of the DBGBCR or DBGWCR are set to a value other than 0b00, the condition for matching refers to the security state of the processor, not the security of the access. For example, the breakpoint or watchpoint does not match when all of the following apply:

- the breakpoint or watchpoint is configured to match in Non-secure state only (0b01)
- the processor is executing code in the Secure state, either because the SCR.NS bit is 0 or because the processor is in Monitor mode
- the address accessed is in a page marked as Non-secure in the translation tables.

For more information about the security of accesses see Chapter B3 *Virtual Memory System Architecture (VMSA)*.

Note

This describes a VMSA access. In ARMv7 the Security Extensions can be implemented only in a system that implements the VMSA.

C10.5.5 Vector Catch Register (DBGVCR)

The Vector Catch Register, DBGVCR, enables Vector Catch debug events. A Vector Catch debug event occurs when:

- a bit in the DBGVCR is set to 1, to enable catches on a particular exception vector
- an IVA matches the corresponding exception vector address
- the instruction is committed for execution.

For more information, see *Vector Catch debug events* on page C3-20.

The DBGVCR is:

- debug register 7, at offset 0x01C.
- a read/write register
- when the Security Extensions are implemented, a Common register.

The format the DBGVCR depends on whether the Security Extensions are implemented, and can depend on the ARM Debug architecture version:

Security Extensions not implemented

Only DBGVCR bits [7:6,4:0] are implemented. All other bits are reserved and UNK/SBZP.

Note

The Security Extensions cannot be implemented with v6 Debug.

v6.1 Debug When the Security Extensions are implemented it is optional whether DBGVCR bits [31,30,28:25,15,14,12:10] are implemented. If these bits are not implemented, they are RAZ/WI. However, for forwards compatibility with v7 Debug, ARM recommends that these bits are implemented.

DBGVCR bits [7:6,4:0] are always implemented. All other bits are reserved and UNK/SBZP.

v7 Debug When the Security Extensions are implemented DBGVCR bits [31,30,28:25,15,14,12:10] must be implemented.

DBGVCR bits [7:6,4:0] are also implemented. All other bits are reserved and UNK/SBZP.

When the Security Extensions are not implemented, and in any v6.1 Debug implementation that does not implement DBGVCR[31,30,28:25,15,14,12:10], the format of the DBGVCR is:

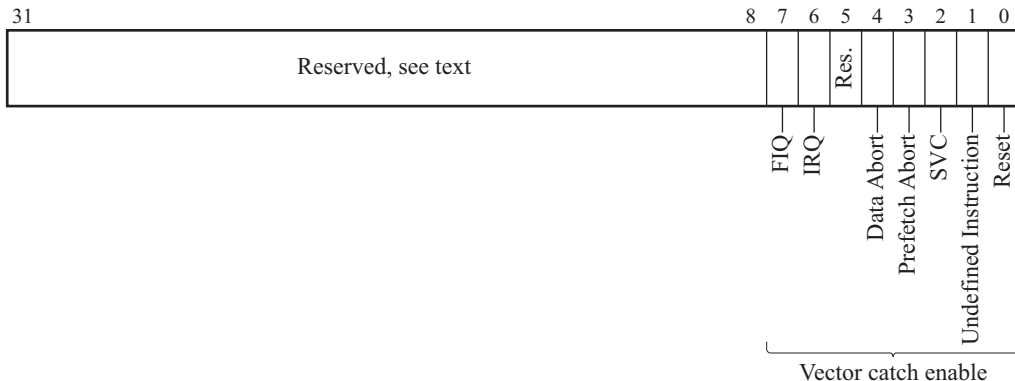

Bits [31:8,5] Reserved. Normally UNK/SBZP, except that in v6.1 Debug bits [31,30,28:25,15,14,12:10] are RAZ/WI, and the other bits are UNK/SBZP.

Bits [7:6,4:0] Vector catch enable bits. When one of these bits is set to 1, any instruction prefetched from the corresponding exception vector generates a Vector Catch debug event when it is committed for execution. Table C10-15 on page C10-71 shows the exception vectors. The Vector Catch enable bits are:

- Bit [7]** FIQ vector catch enable.
- Bit [6]** IRQ vector catch enable.
- Bit [4]** Data Abort vector catch enable.
- Bit [3]** Prefetch Abort vector catch enable.
- Bit [2]** SVC vector catch enable.
- Bit [1]** Undefined Instruction vector catch enable.
- Bit [0]** Reset vector catch enable.

The debug logic reset value of the DBGVCR depends on the ARM Debug architecture version:

v7 Debug Debug logic reset values are UNKNOWN. Before programming DBGDSCR[15:14] to enable debug, a debugger must ensure that the DBGVCR has a defined state.

v6 Debug and v6.1 Debug

All defined bits reset to 0.

If Monitor debug-mode is configured and enabled DBGVCR bits [4:3] must be programmed to 0b00, see *Unpredictable behavior on Software debug events* on page C3-24

For more information about these vector catch operations see *Vector catch operation when Security Extensions are not implemented* on page C10-71.

When the Security Extensions are implemented the format of the DBGVCR is:

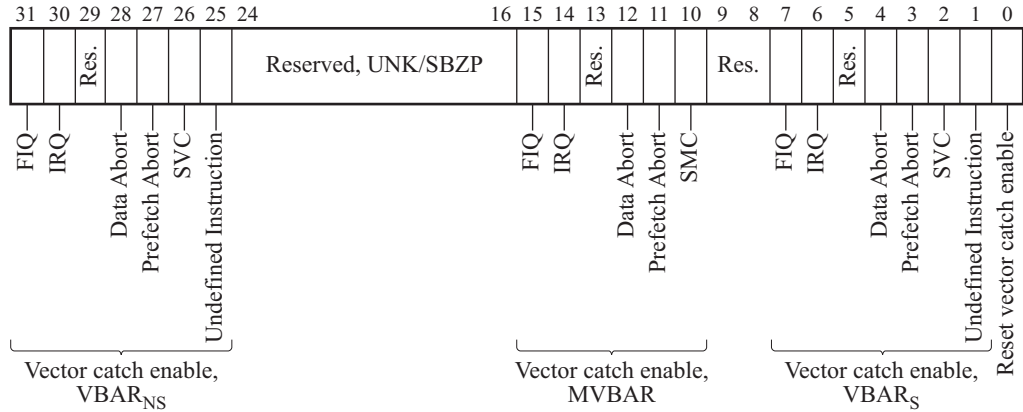
Bits [29,24:14,13,9:8,5]

Reserved. UNK/SBZP.

Bits [31:30,28:25]

Vector catch enable bits for exceptions in the Non-secure state. When one of these bits is set to 1 and the processor is in the Non-secure state, a Vector Catch debug event is generated when an instruction prefetched from the corresponding exception vector is committed for execution. Table C10-16 on page C10-73 shows the exception vectors. The Non-secure state vector catch enable bits are:

- Bit [31]** FIQ vector catch enable in Non-secure state.
- Bit [30]** IRQ vector catch enable in Non-secure state.
- Bit [28]** Data Abort vector catch enable in Non-secure state.
- Bit [27]** Prefetch Abort vector catch enable in Non-secure state.
- Bit [26]** SVC vector catch enable in Non-secure state.
- Bit [25]** Undefined Instruction vector catch enable in Non-secure state.

Bits [15:14,12:10]

Vector catch enable bits for exceptions in the Secure state that are taken on the Monitor mode exception vectors. When one of these bits is set to 1 and the processor is in the Secure state, a Vector Catch debug event is generated when an instruction prefetched from the corresponding exception vector is committed for execution. Table C10-16 on page C10-73 shows the exception vectors. The Monitor mode vector catch enable bits are:

- Bit [15]** FIQ vector catch enable, in Secure state on Monitor mode vector.
- Bit [14]** IRQ vector catch enable in Secure state on Monitor mode vector.
- Bit [12]** Data Abort vector catch enable in Secure state on Monitor mode vector.
- Bit [11]** Prefetch Abort vector catch enable in Secure state on Monitor mode vector.
- Bit [10]** SMC vector catch enable in Secure state.

Bits [7:6,4:1] Vector catch enable bits for exceptions in the Secure state that are taken on the exception mode vector. When one of these bits is set to 1 and the processor is in the Secure state, a Vector Catch debug event is generated when an instruction prefetched from the corresponding exception vector is committed for execution. Table C10-16 on page C10-73 shows the exception vectors. The Secure state vector catch enable bits are:

Bit [7] FIQ vector catch enable in Secure state.

Bit [6] IRQ vector catch enable in Secure state.

Bit [4] Data Abort vector catch enable in Secure state.

Bit [3] Prefetch Abort vector catch enable in Secure state.

Bit [2] SVC vector catch enable in Secure state.

Bit [1] Undefined Instruction vector catch enable in Secure state.

Bit [0] Reset vector catch enable.

When this bit is set to 1, a Vector Catch debug event is generated when an instruction prefetched from the reset exception vector is committed for execution:

- In v7 Debug the debug event is generated regardless of the security state of the processor
- In v6 Debug and v6.1 Debug the debug event is only generated if the processor is in Secure state.

Table C10-16 on page C10-73 shows the exception vectors.

The debug logic reset value of the DBGVCR depends on the ARM Debug architecture version:

v7 Debug Debug logic reset values are UNKNOWN. Before programming DBGDSCR[15:14] to enable debug, a debugger must ensure that the DBGVCR has a defined state.

v6 Debug and v6.1 Debug

All defined bits reset to 0.

If Monitor debug-mode is configured and enabled DBGVCR bits [28:27,12,4:3] must be programmed to zero, see *Unpredictable behavior on Software debug events* on page C3-24

For more information about these vector catch operations see *Vector catch operation when Security Extensions are implemented* on page C10-71.

Vector catch operation

The following subsections give more information about vector catch operation:

- *Vector catch operation when Security Extensions are not implemented* on page C10-71
- *Vector catch operation when Security Extensions are implemented* on page C10-71.

The pseudocode function `VCRMatch()` describes the vector catch operation, for both the Secure and the Non-secure cases, and the function `VCR_OnTakingInterrupt()` tracks the most recent interrupt vectors. For more information about these pseudocode functions and when they are called see *Breakpoints and Vector Catches* on page C3-28.

Vector catch operation when Security Extensions are not implemented

For each bit of the DBGVCR, the vector addresses caught depends on the exception vector configuration in the SCTLAR:

- whether the SCTLAR.V bit is programmed for Normal or High exception vectors
- for catches on the FIQ and IRQ exception vectors, on the programming of the SCTLAR.VE bit.

Table C10-15 shows how the vector address that corresponds to each active bit of the DBGVCR depends on these configuration settings:

Table C10-15 Vector catch addresses, for processors without Security Extensions

DBGVCR bit	Vector catch enabled	Configured exception vectors		
		Normal (V == 0)	High (V == 1)	
[7]	FIQ	VE == 0	0x0000001C	0xFFFF001C
		VE == 1	Most recent FIQ address ^a	
[6]	IRQ	VE == 0	0x00000018	0xFFFF0018
		VE == 1	Most recent IRQ address ^a	
[4]	Data Abort		0x00000010	0xFFFF0010
[3]	Prefetch Abort		0x0000000C	0xFFFF000C
[2]	SVC		0x00000008	0xFFFF0008
[1]	Undefined Instruction		0x00000004	0xFFFF0004
[0]	Reset		0x00000000	0xFFFF0000

a. For more information see *Vector catch debug events and vectored interrupt support* on page C3-22.

Vector catch operation when Security Extensions are implemented

When the Security Extensions are implemented, for each bit of the DBGVCR, the vector addresses caught depends:

- On the value programmed in the appropriate Vector Base Address Register:
 - the Non-secure copy of the Vector Base Address Register (VBAR_{NS}) for the Non-secure state vector catches
 - the Monitor Vector Base Address Register (MVBAR) for the Secure state vector catches on the Monitor mode vectors
 - the Secure copy of the Vector Base Address Register (VBAR_S) for the Secure state vector catches on the exception vectors.

For more information about these registers see:

- *c12*, *Vector Base Address Register (VBAR)* on page B3-148
- *c12*, *Monitor Vector Base Address Register (MVBAR)* on page B3-149.

———— **Note** —————

The Reset exception vectors address never depends on the Vector Base Address values, and when SCTLR.VE == 1 the IRQ and FIQ exception vector addresses do not depend on the Vector Base Address values, see Table C10-16 on page C10-73 for more information.

- Except for the Secure state vector catches on the Monitor mode vectors, on the exception vector configuration in the SCTLR:
 - whether the SCTLR.V bit is programmed for Normal or High exception vectors
 - for catches on the FIQ and IRQ exception vectors, on the programming of the SCTLR.VE bit.

Generation of Vector Catch debug events also depends on the security state of the processor:

- the Non-secure state vector catches are generated only in Non-secure state
- the Secure state vector catches are generated only in Secure state
- in v6 Debug and v6.1 Debug, Reset vector catches are generated only in Secure state.

In v7 Debug, if Reset vector catch is enabled the Reset vector catches are generated regardless of the security state of the processor.

Generation of Vector Catch debug events takes no account of the values in the Secure Configuration Register (SCR), except for SCR.NS. For example, if the DBGVCR is programmed to catch Secure state IRQs on the Monitor mode vector, by setting bit [14] of the DBGVCR to 1, and the processor is in the Secure state, a Vector Catch debug event is generated on any instruction prefetch from (MVBAR + 0x18). This debug event is generated even if the SCR is programmed for IRQs to be handled in IRQ mode.

Table C10-15 on page C10-71 shows, for each active bit of the DBGVCR:

- the security state in which the Vector Catch debug event can occur
- how the corresponding vector address depends on the configuration settings.

Table C10-16 Vector catch operation, when Security Extensions are implemented

DBGVCR bit	Vector catch enable	Security state	Configured exception vectors		
			Normal (V == 0)	High (V == 1)	
Non-secure state vector catches					
[31]	FIQ	VE == 0	Non-secure	$\text{VBAR}_{\text{NS}} + 0x0000001C$	$0xFFFF001C$
		VE == 1	Non-secure	Most recent Non-secure FIQ address ^a	
[30]	IRQ	VE == 0	Non-secure	$\text{VBAR}_{\text{NS}} + 0x00000018$	$0xFFFF0018$
		VE == 1	Non-secure	Most recent Non-secure IRQ address ^a	
[28]	Data Abort	Non-secure	$\text{VBAR}_{\text{NS}} + 0x00000010$	$0xFFFF0010$	
[27]	Prefetch Abort	Non-secure	$\text{VBAR}_{\text{NS}} + 0x0000000C$	$0xFFFF000C$	
[26]	SVC	Non-secure	$\text{VBAR}_{\text{NS}} + 0x00000008$	$0xFFFF0008$	
[25]	Undefined Instruction	Non-secure	$\text{VBAR}_{\text{NS}} + 0x00000004$	$0xFFFF0004$	
Secure state vector catches on Monitor mode vectors					
[15]	FIQ	Secure	$\text{MVBAR} + 0x0000001C$		
[14]	IRQ	Secure	$\text{MVBAR} + 0x00000018$		
[12]	Data Abort	Secure	$\text{MVBAR} + 0x00000010$		
[11]	Prefetch Abort	Secure	$\text{MVBAR} + 0x0000000C$		
[10]	SMC	Secure	$\text{MVBAR} + 0x00000008$		

Table C10-16 Vector catch operation, when Security Extensions are implemented (continued)

DBGVCR bit	Vector catch enable	Security state	Configured exception vectors		
			Normal (V == 0)	High (V == 1)	
Secure state vector catches on exception mode vectors					
[7]	FIQ	VE = 0	Secure	VBAR _S + 0x0000001C	0xFFFF001C
		VE = 1	Secure	Most recent Secure FIQ address ^a	
[6]	IRQ	VE = 0	Secure	VBAR _S + 0x00000018	0xFFFF0018
		VE = 1	Secure	Most recent Secure IRQ address ^a	
[4]	Data Abort		Secure	VBAR _S + 0x00000010	0xFFFF0010
[3]	Prefetch Abort		Secure	VBAR _S + 0x0000000C	0xFFFF000C
[2]	SVC		Secure	VBAR _S + 0x00000008	0xFFFF0008
[1]	Undefined Instruction		Secure	VBAR _S + 0x00000004	0xFFFF0004
Reset vector catch ^b					
[0]	Reset		b	0x00000000	0xFFFF0000

a. For more information see *Vector catch debug events and vectored interrupt support* on page C3-22.

b. ~~The value of the Reset vector is always independent of the Vector Base Address Register values. The security state dependence of Reset vector catches depends on the Debug architecture version. In v7 Debug, Reset vector catches are generated regardless of the security state of the processor. In v6 Debug and v6.1 Debug, Reset vector catches are generated only in Secure state.~~

In a v6.1 Debug implementation on a processor that implements the Security Extensions but does not implement DBGVCR bits [31, 30, 28:25, 15:14, 12:10]:

- in Non-secure state, bits [7:6, 4:1] apply to offsets from VBAR_{NS}.
- in Secure state, bits [7:6, 4:1] apply to offsets from VBAR_S and bits [7:6, 4:2] also apply to offsets from MVBAR_L.

C10.6 OS Save and Restore registers, v7 Debug only

Support for the OS Save and Restore mechanism registers depends on the Debug architecture version:

v6 Debug and v6.1 Debug

These registers are not defined.

v7 Debug If an implementation supports debug over power-down, then it must implement the OS Save and Restore mechanism registers. On SinglePower systems, and on any other system that does not support debug over power-down, it is IMPLEMENTATION DEFINED whether the OS Save and Restore mechanism is implemented.

Any implementation that does not support the OS Save and Restore mechanism must implement ~~the~~ `DBGOSLSR` as RAZ.

This section describes the registers that provide the OS Save and Restore mechanism in the following subsections:

- *OS Lock Access Register (DBGOSLAR)*
- *OS Lock Status Register (DBGOSLSR)* on page C10-76
- *OS Save and Restore Register (DBGOSRR)* on page C10-77.

In addition, the Event Catch Register enables the generation of a debug event when the OS Lock is unlocked. This register is described in *Event Catch Register (DBGECR)* on page C10-78.

C10.6.1 OS Lock Access Register (DBGOSLAR)

The OS Lock Access Register, `DBGOSLAR`, provides a lock for the debug registers. When the registers have been locked any access to the registers returns a slave-generated error response. Writing the key value to the `DBGOSLAR` has the side effect of resetting the internal counter for the OS Save or Restore operation.

You must use the `DBGOSLSR` to check the current status of the lock, see *OS Lock Status Register (DBGOSLSR)* on page C10-76.

The `DBGOSLAR` is:

- debug register 192, at offset `0x300`
- a write-only register
- only defined in v7 Debug
- when the Security Extensions are implemented, a Common register.

————— Note —————

In a v7 Debug implementation that does not implement the OS Save and Restore mechanism, register 192 ~~ignores~~ writes.

In v6 Debug and v6.1 Debug, register 192 is not defined.

The format of the DBGOSLAR is:

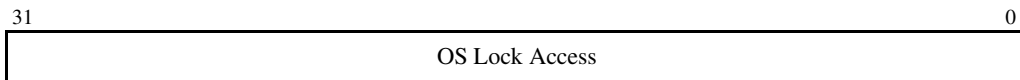

OS Lock Access, bits [31:0]

Writing the key value 0xC5ACCE55 to this field locks the debug registers, and resets the internal counter for the OS Save or Restore operation.

Writing any other value to this register unlocks the debug registers if they are locked.

For details of error responses when accessing the debug registers, see *Access permissions* on page C6-26.

If bit [0] of the Event Catch Register is set to 1 at the point when the OS Lock is unlocked, an OS Unlock Catch debug event is generated, see *Event Catch Register (DBGECR)* on page C10-78.

C10.6.2 OS Lock Status Register (DBGOSLSR)

The OS Lock Status Register, DBGOSLSR, provides status information for the OS Lock.

The DBGOSLSR is:

- debug register 193, at offset 0x304
- a read-only register
- only defined in v7 Debug
- when the Security Extensions are implemented, a Common register.

———— **Note** —————

In any v7 Debug implementation you can read the DBGOSLSR to detect whether the OS Save and Restore mechanism is implemented. If it is not implemented the read of the DBGOSLSR returns zero.

In v6 Debug and v6.1 Debug, register 193 is not defined.

The format of the DBGOSLSR is:

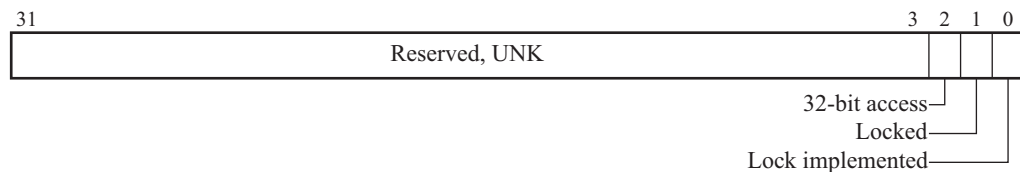

Bits [31:3] Reserved, UNK.

32-bit access, bit [2]

This bit is always RAZ. It indicates that a 32-bit access is needed to write the key to the OS Lock Access Register.

Locked, bit [1]

This bit indicates the status of the OS Lock. The possible values are:

- 0** Lock not set.
- 1** Lock set. ~~Writes to debug registers are ignored.~~

The OS Lock is set or cleared by writing to the DBGOSLAR, see *OS Lock Access Register (DBGOSLAR)* on page C10-75.

On a debug logic reset the state of the OS Lock and the value of this bit are IMPLEMENTATION DEFINED. If the implementation includes the recommended external debug interface they are determined by the value of the **DBGOSLOCKINIT** signal:

DBGOSLOCKINIT LOW

The lock is not set, and the Locked bit is 0

DBGOSLOCKINIT HIGH

The lock is set, and the Locked bit is 1.

Lock implemented, bit [0]

This bit reads 1 if it is possible to set the OS Lock for this processor.

If this bit reads 0, OS Lock and the OS Save and Restore mechanism are not implemented ~~and the entire register is RAZ.~~

C10.6.3 OS Save and Restore Register (DBGOSSRR)

The OS Save and Restore Register, DBGOSSRR, enables the entire debug logic state of the processor to be either saved or restored, by performing a series of reads or writes of the DBGOSSRR. The register works in conjunction with an internal sequence counter to perform the OS Save or Restore operation.

The DBGOSSRR is:

- debug register 194, at offset 0x308
- a read/write register
- only defined in v7 Debug
- when the Security Extensions are implemented, a Common register.

Note

- In a v7 Debug implementation that does not implement the OS Save and Restore mechanism, register 194 ~~is RAZ/WI.~~
- For more information about access permissions in an implementation that includes the OS Save and Restore mechanism but does not provide access to the DBGOSSRR through the external debug interface, see the Note in *The OS Save and Restore mechanism* on page C6-8.

In v6 Debug and v6.1 Debug, register 194 is not defined.

The format of the DBGOSSRR is:

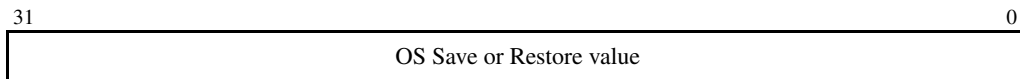

OS Save or Restore value, bits [31:0]

After a write to the DBGOSLAR to lock the debug registers, the first access to the DBGOSSRR must be a read:

- when performing an OS Save sequence this read returns the number of reads from the DBGOSSRR that are needed to save the entire debug logic state
- when performing an OS Restore sequence the value of this read is UNKNOWN and must be discarded.

After that first read access:

- a read of this register returns the next debug logic state value to be saved
- a write to this register restores the next debug logic state value.

Before accessing the DBGOSSRR, you must write to the DBGOSLAR to set the OS Lock, see *OS Lock Access Register (DBGOSLAR)* on page C10-75. This write to the DBGOSLAR resets the internal counter for the OS Save or Restore operation.

The result is UNPREDICTABLE if:

- you access the DBGOSSRR when the OS Lock is not set
- after setting the OS Lock, the first access to the DBGOSSRR is not a read.

See *The OS Save and Restore mechanism* on page C6-8 for a description of using the OS Save and Restore mechanism registers.

C10.6.4 Event Catch Register (DBGECR)

The Event Catch Register, DBGECR, configures the debug logic to generate a debug event when the OS Lock is unlocked.

The DBGECR is:

- debug register 9, at offset 0x024
- a read/write register
- only defined in v7 Debug
- when the Security Extensions are implemented, a Common register.

In v6 Debug and v6.1 Debug, register 9 is not defined.

The format of the DBGECR is:



Bits [31:1] Reserved. UNK/SBZP.

OS Unlock Catch, bit [0]

When this bit is set to 1, an OS Unlock Catch debug event is generated when the OS Lock is unlocked by writing to the DBGOSLAR, see *OS Lock Access Register (DBGOSLAR)* on page C10-75. The possible values of this bit are:

- 0** OS Unlock Catch disabled
- 1** OS Unlock Catch enabled.

The debug logic reset value of this bit is 0.

The OS Unlock Catch bit is part of the OS Save and Restore mechanism. If an implementation supports debug over power-down it must support the OS Save and Restore mechanism, including the OS Unlock Catch debug event. If an implementation does not support debug over power-down, it is IMPLEMENTATION DEFINED whether the OS Save and Restore mechanism and the OS Unlock Catch debug event are supported. If the OS Unlock Catch debug event is not supported then this bit is ~~RAZAWI~~.

The OS Unlock Catch debug event is a Halting debug event, see *Halting debug events* on page C3-38. If a debugger is monitoring an application running on top of an OS with OS Save and Restore capability, this event indicates the right time for the debug session to continue.

———— **Note** —————

The OS Unlock Catch debug event is generated only on clearing of the OS Lock, that is, on the transition of OS Lock from locked to unlocked.

C10.7 Memory system control registers

Support for the Memory system control registers can depend on the Debug architecture version:

v6 Debug and v6.1 Debug

In some v6 Debug and v6.1 Debug implementations a Cache Behavior Override Register (CBOR) is provided in an IMPLEMENTATION DEFINED region of the CP15 register space. In addition, particularly in v6.1 Debug implementations, the Debug State MMU Control Register (DBGDSMCR) and Debug State Cache Control Register (DBGDSCCR) might be implemented as IMPLEMENTATION DEFINED extensions to CP14, as described below.

v6 Debug and v6.1 Debug do not require these registers. However, ARM recommends these features to assist debuggers to maintaining memory coherency, avoiding costly explicit coherency operations.

v7 Debug In v7 Debug, the DBGDSMCR and DBGDSCCR are required, but there can be IMPLEMENTATION DEFINED limits on their behavior. The CP15 register CBOR remains IMPLEMENTATION DEFINED.

The Memory system control registers are described in the subsections:

- *Debug State Cache Control Register (DBGDSCCR)* on page C10-81
- *Debug State MMU Control Register (DBGDSMCR)* on page C10-84.

The Debug State Cache Control Register (DBGDSCCR) and Debug State MMU Control Register (DBGDSMCR) control cache and TLB behavior for memory operations issued by a debugger when the processor is in Debug state. They enable a debugger to request the minimum amount of intrusion to the processor caches, as permitted by the implementation. It is IMPLEMENTATION DEFINED what levels of cache and TLB are controlled by these requests, and it is IMPLEMENTATION DEFINED to what extent the intrusion is limited.

The DBGDSCCR also provides a mechanism for a debugger to force writes to memory through to the point of coherency without the overhead of issuing additional operations.

The DBGDSCCR and DBGDSMCR controls must apply for all memory operations issued in Debug state when DBGDSMCR.ADAdiscard, the Asynchronous Data Aborts Discarded bit, is set to 1. It is IMPLEMENTATION DEFINED whether memory operations issued in Debug state whilst this bit is not set to 1 are affected by the DBGDSCCR and DBGDSMCR.

C10.7.1 Debug State Cache Control Register (DBGDSCCR)

The Debug State Cache Control Register, DBGDSCCR, controls cache behavior when the processor is in Debug state.

The DBGDSCCR is:

- debug register 10, at offset 0x028
- a read/write register, with some bits that might not be implemented and therefore are RAZ/WI
- required in v7 Debug
- when the Security Extensions are implemented, a Common register.

It is IMPLEMENTATION DEFINED whether the DBGDSCCR is included in a v6 Debug or v6.1 Debug implementation.

The format of the DBGDSCCR is:

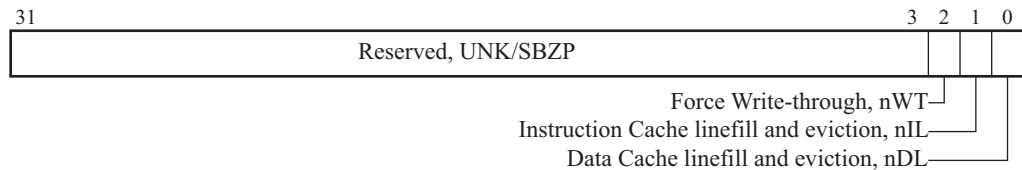

Bits [31:3] Reserved, UNK/SBZP.

Force Write-Through, nWT, bit [2]

The possible values of this bit are:

- 0** Force Write-Through behavior for memory operations issued by a debugger when the processor is in Debug state
- 1** Normal operation for memory operations issued by a debugger when the processor is in Debug state.

In Debug state, if the nWT bit is set to 0, when a write to memory completes the effect of the write must be visible at all levels of memory to the point of coherency. This means a debugger can write through to the point of coherency without having to perform any cache clean operations.

If implemented, the nWT control must act at all levels of memory to the point of coherency.

If the nWT control is not implemented this bit is RAZ/WI.

Note

nWT does not force the ordering of writes, and does not force writes to complete immediately. A debugger might have to insert a barrier operations to ensure ordering.

Cache linefill and eviction bits, bits [1:0]

Either or both of these bits might not be implemented, in which case the bit is RAZ/WI. If implemented these bits are:

nIL, bit [1] Instruction cache, where separate data and instruction caches are implemented.

nDL, bit [0] Data or unified cache.

The possible values of an implemented bit are:

0 Request disabling of cache linefills and evictions for memory operations issued by a debugger when the processor is in Debug state

1 Normal operation of cache linefills and evictions for memory operations issued by a debugger when the processor is in Debug state.

When cache linefill and eviction is disabled, all memory accesses that would be checked against a cache are checked against the cache. If a match is found, the cached result is used. If no match is found the next level of memory is used, but the result is not cached, and no cache entries are evicted.

The *next level of memory* can refer to looking in the next level of cache, or to accessing external memory, depending on the numbers of levels of cache implemented.

When the processor is in Debug state, cache maintenance operations are not affected by the nDL and nIL control bits, and have their normal architecturally-defined behavior.

The memory hint instructions PLD and PLI have UNPREDICTABLE behavior in Debug state when the corresponding nDL or nIL control bit is set to 1.

The debug logic reset value of the DBGDSCCR depends on the ARM Debug architecture version:

v7 Debug Debug logic reset values are UNKNOWN. Before issuing operations through the DBGITR with the processor in Debug state, a debugger must ensure that the DBGDSCCR has a defined state.

ARMv6 All defined bits reset to 0.

Permitted IMPLEMENTATION DEFINED limits

The DBGDSCCR is required. However, there can be IMPLEMENTATION DEFINED limits on its behavior. Table C10-17 lists some examples of possible options for implementations.

Table C10-17 Permitted IMPLEMENTATION DEFINED limits on DBGDSCCR behavior

Limit	Description	Notes
Full DBGDSCCR	Bits [2:0] implemented	-
No Write-Back support	Bit [2] is RAZ/WI	-
No Write-Through support	Bit [2] is RAZ/WI	Force Write-Through feature not supported. If Secure User halting debug is supported the implementation must provide cache clean operations in Debug state, see <i>Access to specific cache management functions in Debug state</i> on page C5-25.
No I-cache control	Bit [1] is RAZ/WI	Instruction cache linefill and eviction disable features not implemented. Instruction fetches are disabled in Debug state. For most implementations no instruction cache accesses take place in Debug state, and nIL is not required.
Unified cache	Bit [1] is RAZ/WI	-
Cache evictions always enabled	-	nIL and nDL disable cache linefills in Debug state. However cache evictions might still take place even when these control bits are set to 0.
No linefill control	Bits [1:0] are RAZ/WI	No cache linefill and eviction disable features are implemented.

Interaction with Cache Behavior Override Register

An IMPLEMENTATION DEFINED Cache Behavior Override Register (CBOR) might also be implemented in CP15.

Table C10-18 on page C10-84 shows, for a processor that implements both the Debug state Cache Control Register (DBGDSCCR) and the CBOR, the relative precedence of the CBOR and the DBGDSCCR according to the state of the processor.

Table C10-18 Interaction of CP15 Cache Behavior Override Register (CBOR) and DBGDSCCR

DBGDSCCR setting	CBOR setting	Debug state	Behavior
nWT = 1	WT = 0	X	Areas marked WB are Write-Back
nWT = X	WT = 0	No	Areas marked WB are Write-Back
nWT = X	WT = 1	X	Areas marked WB are Write-Through
nWT = 0	WT = X	Yes	Areas marked WB are Write-Through
nDL = 1	DL = 0	X	Data or unified cache linefills are enabled
nDL = X	DL = 0	No	Data or unified cache linefills are enabled
nDL = X	DL = 1	X	Data or unified cache linefills are disabled
nDL = 0	DL = X	Yes	Data or unified cache linefills are disabled
nIL = 1	IL = 0	X	Instruction cache linefills are enabled
nIL = X	IL = 0	No	Instruction cache linefills are enabled
nIL = X	IL = 1	X	Instruction cache linefills are disabled
nIL = 0	IL = X	Yes	Instruction cache linefills are disabled

A processor that does not implement Security Extensions has only WT, IL and DL settings in the CP15 Cache Behavior Override Register. Processors that implement Security Extensions can have separate settings for, for example, NS_WT and S_WT in the CP15 Cache Behavior Override Register. For brevity Table C10-18 does not show the full matrix of possibilities in this case. For the behavior on such a processor, duplicate Table C10-18:

- once for the Non-secure case, for example NS_WT
- once for the Secure case, for example S_WT.

C10.7.2 Debug State MMU Control Register (DBGDSMCR)

The Debug State MMU Control Register, DBGDSMCR, controls TLB behavior when the processor is in Debug state.

The DBGDSMCR is:

- debug register 11, at offset 0x02C
- a read/write register, with some bits that might not be implemented and therefore are RAZ/WI
- required in v7 Debug
- when the Security Extensions are implemented, a Common register.

It is IMPLEMENTATION DEFINED whether the DBGDSMCR is included in a v6 Debug or v6.1 Debug implementation.

The format of the DBGDSMCR is:

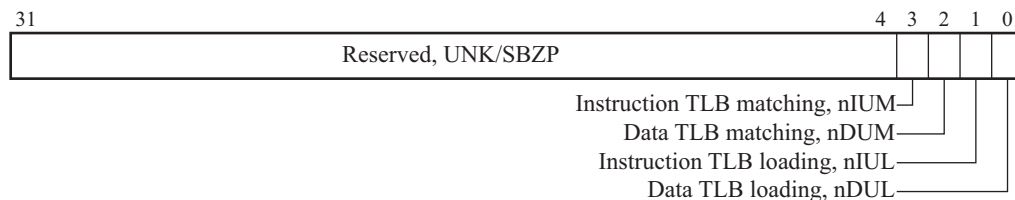

Bits [31:4] Reserved, UNK/SBZP.

TLB matching bits, bits [3:2]

Either or both of these bits might not be implemented, in which case the bit is RAZ/WI. If implemented these bits are:

nIUM, bit [3] Instruction TLB matching bit, where separate Data and Instruction TLBs are implemented.

nDUM, bit [2] Data or Unified TLB matching bit.

The possible values of an implemented TLB matching bit are:

0 Request disabling of TLB matching for memory operations issued by a debugger when the processor is in Debug state

1 Normal operation of TLB matching for memory operations issued by a debugger when the processor is in Debug state.

When TLB matching is disabled, all memory accesses normally checked against a TLB are not checked against the TLB. For every access the next level of translation is performed. The results are not cached in the TLB, and no TLB entries are evicted. The next level of translation is used for every access.

The *next level of translation* might mean looking in the next level TLB, or doing a translation table walk, depending on the numbers of levels of TLB implemented.

Note

If TLB matching is disabled, and TLB maintenance functions have not been correctly performed by the system being debugged, for example, if the TLB has not been flushed following a change to the translation tables, memory accesses made by the debugger might not undergo the same virtual to physical memory mappings as the application being debugged.

A debugger can create temporary alternative memory mappings by altering the contents of the external translation tables and disabling all levels of TLB matching. However, for normal debugging operations, ARM recommends that the TLB Matching bit is set to 1.

TLB loading bits, bits [1:0]

Either or both of these bits might not be implemented, in which case the bit is RAZ/WI. If implemented these bits are:

nIUL, bit [1] Instruction TLB loading bit, where separate Data and Instruction TLBs are implemented.

nDUL, bit [0] Data or Unified TLB loading bit.

The possible values of an implemented TLB loading bit are:

0 Request disabling of TLB load and flush for memory operations issued by a debugger when the processor is in Debug state

1 Normal operation of TLB loading and flushing for memory operations issued by a debugger when the processor is in Debug state.

When TLB load and flush is disabled, all memory accesses normally checked against a TLB are checked against the TLB. If a match is found, the cached result is used. If no match is found the next level of translation is performed, but the result is not cached in the TLB, and no TLB entries are evicted.

The *next level of translation* might mean looking in the next level TLB, or doing a translation table walk, depending on the numbers of levels of TLB implemented.

In Debug state, TLB maintenance operations are not affected by the nDUL and nIUL control bits, and have their normal architecturally-defined behavior.

The debug logic reset value of the DBGDSMCR depends on the ARM Debug architecture version:

v7 Debug Debug logic reset values are UNKNOWN. Before issuing operations through the DBGITR with the processor in Debug state, a debugger must ensure that the DBGDSMCR has a defined state.

v6 Debug, v6.1 Debug

All defined bits reset to 0.

Permitted IMPLEMENTATION DEFINED limits

The DBGDSMCR is required. However, there can be IMPLEMENTATION DEFINED limits on its behavior. Table C10-19 lists six permitted options for implementations. Some of these options are orthogonal.

Table C10-19 Permitted IMPLEMENTATION DEFINED limits on DBGDSCCR behavior

Limit	Description	Notes
Full DBGDSMCR	Bits [3:0] implemented	-
No I-TLB controls	Bits [3,1] are RAZ/WI	Instruction cache linefill and eviction disable features not implemented. Instruction fetches disabled in Debug state. For most implementations no TLB accesses take place in Debug state, and nIUL and nIUM are not required.
Unified TLB	Bits [3,1] are RAZ/WI	-
No matching control	Bits [3:2] are RAZ/WI	The TLB matching controls are not used to reduce the impact of debugging, only for advanced debugging features. If not implemented, these bits are RAZ, although the processor behaves as if they were set to 1.
TLB evictions always enabled	-	nIUL and nDUL disable TLB loading in Debug state. However TLB evictions can still take place even when these control bits are set to 0.
No loading control	Bits [1:0] are RAZ/WI	-

C10.8 Management registers, ARMv7 only

Support for the management registers depends on the ARM architecture version:

ARMv6 These registers are not defined in ARMv6.

ARMv7 The processor identification registers are summarized in this section and are defined in one or more of:

- *CP15 registers for a VMSA implementation* on page B3-64
- *CP15 registers for a PMSA implementation* on page B4-22
- Chapter B5 *The CPUID Identification Scheme*.

Additional management registers are defined in this section.

The layout of the management registers, registers 832-1023, complies with the *CoreSight Architecture Specification*.

Processor identification registers summarizes the processor identification registers.

The following sections describe the remaining management registers:

- *Integration Mode Control Register (DBGITCTRL)* on page C10-91
- *Claim Tag Set Register (DBGCLAIMSET)* on page C10-92
- *Claim Tag Clear Register (DBGCLAIMCLR)* on page C10-93
- *Lock Access Register (DBGLAR)* on page C10-94
- *Lock Status Register (DBGLSR)* on page C10-95
- *Authentication Status Register (DBGAUTHSTATUS)* on page C10-96
- *Device Type Register (DBGDEVTYPE)* on page C10-98
- *Debug Peripheral Identification Registers (DBGPID0 to DBGPID4)* on page C10-98
- *Debug Component Identification Registers (DBGCID0 to DBGCID3)* on page C10-102

C10.8.1 Processor identification registers

The processor identification registers return the values stored in the Main ID and feature registers of the processor.

The processor identification registers are:

- debug registers 832-895, at offsets 0xD00-0xDFC
- read-only registers.

Note

The Extended CP14 interface MRC and MCR instructions that map to these registers are UNDEFINED in User mode and UNPREDICTABLE in privileged modes. The CP15 interface must be used to access these registers.

Table C10-20 on page C10-89 lists the processor identification registers, in register number order.

Table C10-20 Processor identification registers

Register number	Access ^a	Mnemonic	Register
832	Read-only	MIDR	Main ID Register ^b
833	Read-only	CTR	Cache Type Register ^b
834	Read-only	TCMTR	TCM Type Register ^b
835	Read-only	TLBTR	TLB Type Register ^b
836	Read-only	MPUIR	MPU Type Register ^b
837	Read-only	MPIDR	Multiprocessor Affinity Register ^b
838, 839	Read-only	-	Alias of Main ID Register ^b
840	Read-only	ID_PFR0	Processor Feature Register 0
841	Read-only	ID_PFR1	Processor Feature Register 1
842	Read-only	ID_DFR0	Debug Feature Register 0
843	Read-only	ID_AFR0	Auxiliary Feature Register 0
844	Read-only	ID_MMFR0	Memory Model Feature Register 0
845	Read-only	ID_MMFR1	Memory Model Feature Register 1
846	Read-only	ID_MMFR2	Memory Model Feature Register 2
847	Read-only	ID_MMFR3	Memory Model Feature Register 3
848	Read-only	ID_ISAR0	Instruction Set Attribute Register 0
849	Read-only	ID_ISAR1	Instruction Set Attribute Register 1
850	Read-only	ID_ISAR2	Instruction Set Attribute Register 2
851	Read-only	ID_ISAR3	Instruction Set Attribute Register 3
852	Read-only	ID_ISAR4	Instruction Set Attribute Register 4
853	Read-only	ID_ISAR5	Instruction Set Attribute Register 5
854-895	-	-	Reserved, UNK/SBZP

- a. For more information, see *CPI4 debug registers access permissions* on page C6-36 and *Permission summaries for memory-mapped and external debug interfaces* on page C6-45.
- b. Identification registers with register numbers 832-839 return the same value as an MRC instruction `MRC p15,0,<Rt>,c0,c0,<opc2>`, where `<opc2>` = (register number - 832).

Some of these registers form part of the CPUID scheme and are described in Chapter B5 *The CPUID Identification Scheme*. The other ARMv7 registers are described in either or both of:

- *CP15 registers for a VMSA implementation* on page B3-64
- *CP15 registers for a PMSA implementation* on page B4-22.

Table C10-21 shows where each register is described

Table C10-21 Index to descriptions of the processor Identification registers

Register	Description, VMSA	Description, PMSA
Main ID Register	<i>c0, Main ID Register (MIDR)</i> on page B3-81	<i>c0, Main ID Register (MIDR)</i> on page B4-32
Cache Type Register	<i>c0, Cache Type Register (CTR)</i> on page B3-83	<i>c0, Cache Type Register (CTR)</i> on page B4-34
TCM Type Register	<i>c0, TCM Type Register (TCMTR)</i> on page B3-85	<i>c0, TCM Type Register (TCMTR)</i> on page B4-35
TLB Type Register	<i>c0, TLB Type Register (TLBTR)</i> on page B3-86	VMSA only. Alias of Main ID Register.
MPU Type Register	PMSA only. Alias of Main ID Register.	<i>c0, MPU Type Register (MPUIR)</i> on page B4-36
Multiprocessor Affinity Register	<i>c0, Multiprocessor Affinity Register (MPIDR)</i> on page B3-87	<i>c0, Multiprocessor Affinity Register (MPIDR)</i> on page B4-37
Processor Feature Register 0	<i>CP15 c0, Processor Feature registers</i> on page B5-4	
Processor Feature Register 1		
Debug Feature Register 0	<i>c0, Debug Feature Register 0 (ID_DFR0)</i> on page B5-6	
Auxiliary Feature Register 0	<i>c0, Auxiliary Feature Register 0 (ID_AFR0)</i> on page B5-8	
Memory Model Feature Register 0 to Memory Model Feature Register 3	<i>CP15 c0, Memory Model Feature registers</i> on page B5-9	
Instruction Set Attribute Register 0 to Instruction Set Attribute Register 5	<i>CP15 c0, Instruction Set Attribute registers</i> on page B5-19	

C10.8.2 Integration Mode Control Register (DBGITCTRL)

The Integration Mode Control Register, DBGITCTRL, enables the device to switch from its default functional mode into *integration mode*, where the inputs and outputs of the device can be directly controlled for integration testing or topology detection. When the processor is in integration mode, the IMPLEMENTATION DEFINED integration registers can be used to drive output values and to read inputs.

The DBGITCTRL Register is:

- debug register 960, at offset 0xF00
- a read/write register
- when the Security Extensions are implemented, a Common register.

The format of the DBGITCTRL Register is:



Bits [31:1] Reserved, UNK/SBZP.

Integration mode enable, bit [0]

The possible values of this bit are:

- 0** Normal operation
- 1** Integration mode enabled.

When this bit is set to 1, the device reverts to an integration mode to enable integration testing or topology detection. The integration mode behavior is IMPLEMENTATION DEFINED.

C10.8.3 Claim Tag Set Register (DBGCLAIMSET)

The Claim Tag Set Register, DBGCLAIMSET, enables the CLAIM bits, bits [7:0] of the register, to be set to 1. CLAIM bits do not have any specific functionality. ARM expects the usage model to be that an external debugger and a debug monitor can set specific bits to 1 to claim the corresponding debug resources.

The CLAIM bits are always RAO in the DBGCLAIMSET Register. This enables a debugger to identify the number of CLAIM bits that are implemented. See *Claim Tag Clear Register (DBGCLAIMCLR)* on page C10-93 for details of how to:

- clear CLAIM bits to 0
- read the current values of the CLAIM bits.

The DBGCLAIMSET Register is:

- debug register 1000, at offset 0xFA0
- a read/write register, in which:
 - the CLAIM bits are always RAO
 - writing 0 to a CLAIM bit has no effect
- when the Security Extensions are implemented, a Common register.

The format of the DBGCLAIMSET Register is:

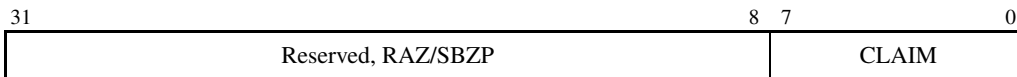

Bits [31:8] Reserved, RAZ/SBZP.

CLAIM bits, bits [7:0]

Writing a 1 to one of these bits sets the corresponding CLAIM bit to 1. Multiple bits can be set to 1 in a single write operation.

Writing 0 to one of these bits has no effect.

You must use the DBGCLAIMCLR Register to:

- read the values of the CLAIM bits
- clear a CLAIM bit to 0.

These bits are always RAO.

If a debugger reads this register, the bits that are set to 1 correspond to the implemented CLAIM bits.

C10.8.4 Claim Tag Clear Register (DBGCLAIMCLR)

The Claim Tag Clear Register, DBGCLAIMCLR, enables the values of the CLAIM bits, bits [7:0] of the register, to be:

- read
- cleared to 0.

For more information about the CLAIM bits and how they might be used, see *Claim Tag Set Register (DBGCLAIMSET)* on page C10-92.

The DBGCLAIMCLR Register is:

- debug register 1001, at offset 0xFA4
- a read/write register, in which:
 - writing 0 to a CLAIM bit has no effect
 - writing 1 to a CLAIM bit clears that bit to 0
 - a read of the register returns the current values of the CLAIM bits
- when the Security Extensions are implemented, a Common register.

The format of the DBGCLAIMCLR Register is:

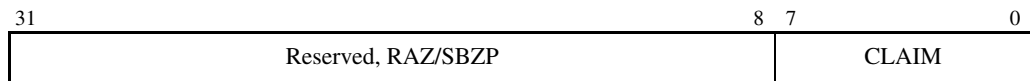

Bits [31:8] Reserved, RAZ/SBZP.

CLAIM bits, bits [7:0]

Writing a 1 to one of these bits clears the corresponding CLAIM bit to 0. Multiple bits can be cleared to 0 in a single write operation.

Writing 0 to one of these bits has no effect.

Reading the register returns the current values of these bits.

The debug logic reset value of each of these bits is 0.

C10.8.5 Lock Access Register (DBGLAR)

The Lock Access Register, DBGLAR, provides a lock on writes to the debug registers through the memory-mapped interface. Use of this lock mechanism reduces the risk of accidental damage to the contents of the debug registers. It does not, and cannot, prevent all accidental or malicious damage.

You must use the DBGLSR to check the current status of the lock, see *Lock Status Register (DBGLSR)* on page C10-95.

The DBGLAR is:

- debug register 1004, at offset 0xFB0
- a write-only register
- only defined in the memory-mapped interface
- when the Security Extensions are implemented, a Common register.

Note

- Debug register 1004, at offset 0xFB0, is reserved in both the Extended CP14 interface and the external debug interface.
- Do not confuse the Software Lock mechanism with the OS Lock described in *The OS Save and Restore mechanism* on page C6-8.

The format of the DBGLAR is:

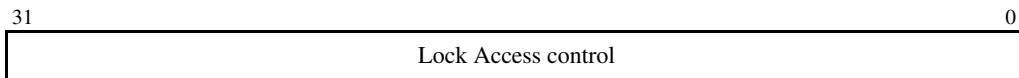

Lock Access control, bits [31:0]

Writing the key value 0xC5ACCE55 to this field clears the lock, enabling write accesses to the debug registers through the memory-mapped interface.

Writing any other value to this register sets the lock, disabling write accesses to the debug registers through the memory-mapped interface.

Note

- In implementations with separate core and debug power-domains, this lock is maintained in the debug power domain. Its state is unaffected by the core power domain powering down.
- This lock is set on debug logic reset, that is, on a **PRESETDBGn** or **nSYSPORESET** reset.

Accesses through the memory-mapped interface to locked debug registers are ignored. For more information, see *Permissions in relation to locks* on page C6-27.

C10.8.6 Lock Status Register (DBGLSR)

The Lock Status Register, DBGLSR, provides status information for the debug registers lock. For more information about this lock see *Lock Access Register (DBGLAR)* on page C10-94.

The DBGLSR is:

- debug register 1005, at offset 0xFB4
- a read-only register
- only defined in the memory-mapped interface
- when the Security Extensions are implemented, a Common register.

———— Note ————

Debug register 1005, at offset 0xFB4, is reserved in both the Extended CP14 interface and the external debug interface.

The format of the DBGLSR is:

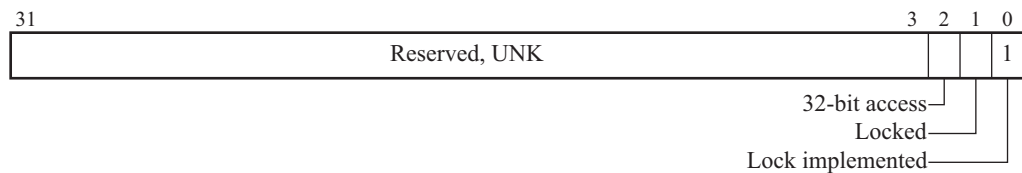

Bits [31:3] Reserved, UNK.

32-bit access, bit [2]

This bit is always RAZ. It indicates that a 32-bit access is needed to write the key to the Lock Access Register.

Locked, bit [1]

This bit indicates the status of the debug registers lock. The possible values are:

- 0** Lock clear. Debug register writes are permitted.
- 1** Lock set. Debug register writes are ignored.

The debug registers lock is set or cleared by writing to the DBGLAR, see *Lock Access Register (DBGLAR)* on page C10-94.

The debug logic reset value of this bit is 1.

Lock implemented, bit [0]

This bit is RAO.

C10.8.7 Authentication Status Register (DBGAUTHSTATUS)

The Authentication Status Register, DBGAUTHSTATUS, indicates the implemented debug features and provides the current values of the configuration inputs that determine the debug permissions. The value returned depends on whether the processor implements the Security Extensions.

The DBGAUTHSTATUS Register is:

- debug register 1006, at offset 0xFB8
- a read-only register
- when the Security Extensions are implemented, a Common register.

When the Security Extensions are implemented, the format of the DBGAUTHSTATUS Register is:

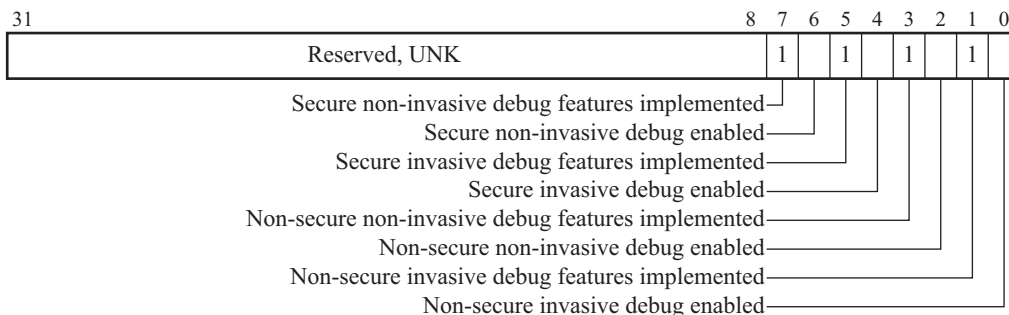

Bits [31:8] Reserved, UNK.

Secure non-invasive debug features implemented, bit [7]

This bit is RAO, Secure non-invasive debug features are implemented.

Secure non-invasive debug enabled, bit [6]

This bit indicates the logical result of:
(DBGEN OR NIDEN) AND (SPIDEN OR SPNIDEN).

Secure invasive debug features implemented, bit [5]

This bit is RAO, Secure invasive debug features are implemented.

Secure invasive debug enabled, bit [4]

This bit indicates the logical result of **(DBGEN AND SPIDEN).**

Non-secure non-invasive debug features implemented, bit [3]

This bit is RAO, Non-secure non-invasive debug features are implemented.

Non-secure non-invasive debug enabled, bit [2]

This bit indicates the logical result of **(DBGEN OR NIDEN)**

If a processor does not implement the Security Extensions, it does not implement any Non-secure debug features.

C10.8.8 Device Type Register (DBGDEVTYPE)

The Device Type Register, DBGDEVTYPE, provides the CoreSight device type information for the Debug architecture. The DBGDEVTYPE register must be implemented in all CoreSight components, and indicates the type of debug component.

The DBGDEVTYPE Register is:

- debug register 1011, at offset 0xFCC
- a read-only register
- when the Security Extensions are implemented, a Common register.

The format of the DBGDEVTYPE Register is:



Bits [31:8] Reserved, RAZ.

Sub type, bits [7:4]

This field reads as 0x1, indicating a processor.

Main class, bits [3:0]

This field reads as 0x5, indicating Debug logic.

For more information about the CoreSight registers see the *CoreSight Architecture Specification*.

C10.8.9 Debug Peripheral Identification Registers (DBGPID0 to DBGPID4)

The Debug Peripheral Identification Registers provide standard information required by all components that conform to the ARM Debug Interface v5 specification. They identify a peripheral in a particular namespace. For more information, see the *ARM Debug Interface v5 Architecture Specification*.

The Debug Peripheral Identification Registers are:

- debug registers 1012-1019, at offsets 0xFD0-0xFEC
- read-only registers.
- when the Security Extensions are implemented, Common registers.

Note

- ARMv7 only defines Debug Peripheral ID Registers 0 to 4, and reserves space for Debug Peripheral ID Registers 5 to 7.
- The register number order of the Debug Peripheral ID Registers does not match the numerical order ID0 to ID7, see Table C10-22.

Table C10-22 lists the Debug Peripheral Identification Registers in register number order.

Table C10-22 Debug Peripheral Identification Registers

Register: Number	Offset	Description	Reference
1012	0xFD0	Debug Peripheral ID4	<i>DBGPID4</i> on page C10-102
1013	0xFD4	Reserved for Debug Peripheral ID5, DBGPID5	-
1014	0xFD8	Reserved for Debug Peripheral ID6, DBGPID6	-
1015	0xFDC	Reserved for Debug Peripheral ID7, DBGPID7	-
1016	0xFE0	Debug Peripheral ID0	<i>DBGPID0</i> on page C10-101
1017	0xFE4	Debug Peripheral ID1	<i>DBGPID1</i> on page C10-101
1018	0xFE8	Debug Peripheral ID2	<i>DBGPID2</i> on page C10-101
1019	0xFEC	Debug Peripheral ID3	<i>DBGPID3</i> on page C10-101

Only bits [7:0] of each Debug Peripheral ID Register are used. This means that the format of each register is:

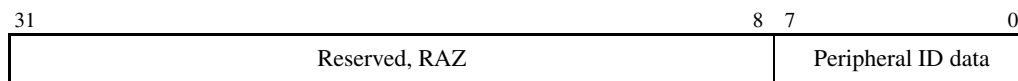

The eight Debug Peripheral ID Registers can be considered as defining a single 64-bit Peripheral ID, as shown in Figure C10-1.

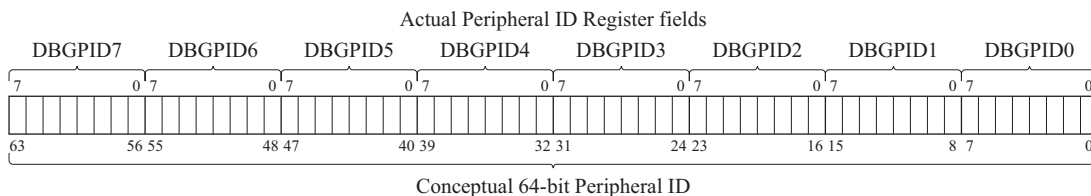
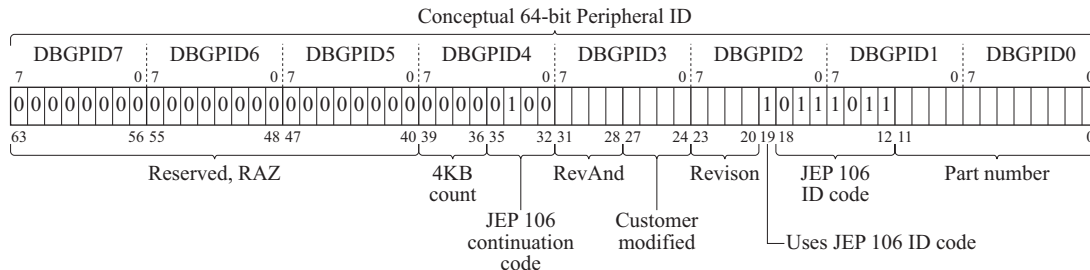

Figure C10-1 Mapping between Debug Peripheral ID Registers and a 64-bit Peripheral ID value

Figure C10-2 shows the fields in the 64-bit Peripheral ID value, and includes the field values for fields that:

- have fixed values, including the bits that are reserved, RAZ
- have fixed values in a device that is designed by ARM.

For more information about the fields and their values see Table C10-23.



Bits with no value shown are IMPLEMENTATION DEFINED
 Some bit values shown are for a device designed by ARM Limited. See text for details.

Figure C10-2 Peripheral ID fields, with values for a design by ARM

Table C10-23 shows the fields in the Peripheral ID.

Table C10-23 Fields in the Debug Peripheral Identification Registers

Name	Size	Description	Register
4KB count	4 bits	Log ₂ of the number of 4KB blocks occupied by the device. In v7 Debug, the debug registers occupy a single 4KB block, so this field is always 0x0.	DBGPID4
JEP 106 code	4+7 bits	Identifies the designer of the device. This value consists of: a 4-bit continuation code, also described as the bank number a 7-bit identity code. For implementations designed by ARM, the continuation code is 0x4 (bank 5), and the identity code is 0x3B. For more information, see <i>JEP106, Standard Manufacturers Identification Code</i> .	DBGPID1, DBGPID2, DBGPID4
RevAnd	4 bits	Manufacturing Revision Number. Indicates a late modification to the device, usually as a result of an Engineering Change Order. This field starts at 0x0 and is incremented by the integrated circuit manufacturer on metal fixes.	DBGPID3
Customer modified	4 bits	Indicates an endorsed modification to the device. If the system designer cannot modify the RTL supplied by the processor designer then this field is RAZ.	DBGPID3

Table C10-23 Fields in the Debug Peripheral Identification Registers (continued)

Name	Size	Description	Register
Revision	4 bits	Revision number for the device. Starts at 0x0 and increments by 1 at both major and minor revisions.	DBGPID2
Uses JEP 106 ID code	1 bit	This bit is set to 1 when a JEP 106 Identity Code is used. This bit must be 1 on all ARMv7 implementations.	DBGPID2
Part Number	12 bits	Part number for the device. Each organization designing devices to the ARM Debug architecture specification keeps its own part number list.	DBGPID0, DBGPID1

For more information about these fields, see the *ARM Debug Interface v5 Architecture Specification*.

The following subsections describe the formats of each of the implemented Debug Peripheral ID Registers.

DBGPID0

DBGPID0 is debug register 1016 at offset 0xFE0. Its format is:

Bits [31:8] Reserved, RAZ.

Part number[7:0], bits [7:0]

Bits [7:0] of the IMPLEMENTATION DEFINED Part number.

DBGPID1

DBGPID1 is debug register 1017 at offset 0xFE4. Its format is:

Bits [31:8] Reserved, RAZ.

JEP Identity Code[3:0], bits [7:4]

Bits [3:0] of the IMPLEMENTATION DEFINED JEP Identity Code.

For a device designed by ARM the JEP Identity Code is 0x3B and therefore this field is 0xB.

Part number[11:8], bits [3:0]

Bits [11:8] of the IMPLEMENTATION DEFINED Part number.

DBGPID2

DBGPID2 is debug register 1018 at offset 0xFE8. Its format is:

Bits [31:8] Reserved, RAZ.

Revision, bits [7:4]

The IMPLEMENTATION DEFINED revision number for the device.

Uses JEP Code, bit [3]

For an ARMv7 implementation this bit must be one, indicating that the Peripheral ID uses a JEP 106 Identity Code.

JEP Identity Code[6:4], bits [2:0]

Bits [6:4] of the IMPLEMENTATION DEFINED JEP Identity Code.

For a device designed by ARM the JEP Identity Code is 0x3B and therefore this field is 0b011.

DBGPID3

DBGPID3 is debug register 1019 at offset 0xFEC. Its format is:

Bits [31:8] Reserved, RAZ.

RevAnd, bits [7:4]

The IMPLEMENTATION DEFINED manufacturing revision number for the device.

Customer modified, bits [3:0]

An IMPLEMENTATION DEFINED value that indicates an endorsed modification to the device.

If the system designer cannot modify the RTL supplied by the processor designer then this field is RAZ.

DBGPID4

DBGPID4 is debug register 1012 at offset 0xFD0. Its format is:

Bits [31:8] Reserved, RAZ.

4KB count, bits [7:4]

This field is RAZ for all ARMv7 implementations.

JEP 106 Continuation code, bits [3:0]

The IMPLEMENTATION DEFINED JEP 106 Continuation code.

For a device designed by ARM this field is 0x4.

C10.8.10 Debug Component Identification Registers (DBGCID0 to DBGCID3)

The Debug Component Identification Registers identify the processor as an ARM Debug Interface v5 Component. For more information, see the *ARM Debug Interface v5 Architecture Specification*.

The Debug Component Identification Registers:

- are debug registers 1020-1023, at offsets 0xFF0-0xFFC
- are read-only registers

- occupy the last four words of the 4KB block of debug registers
- when the Security Extensions are implemented, are Common registers.

Table C10-24 lists the Debug Component Identification Registers.

Table C10-24 Debug Component Identification Registers

Register:		Description	Reference
Number	Offset		
1020	0xFF0	Debug Component ID0	<i>DBGCID0</i>
1021	0xFF4	Debug Component ID1	<i>DBGCID1</i> on page C10-104
1022	0xFF8	Debug Component ID2	<i>DBGCID2</i> on page C10-104
1023	0xFFC	Debug Component ID3	<i>DBGCID3</i> on page C10-104

Only bits [7:0] of each Debug Component ID Register are used. This means that the format of each register is:

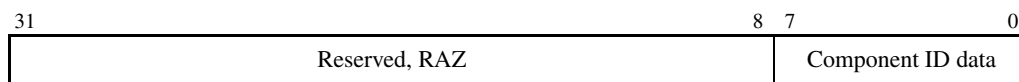

The four Debug Component ID Registers can be considered as defining a single 32-bit Component ID, as shown in Figure C10-3. The value of this Component ID is fixed.

Actual Component ID Register fields

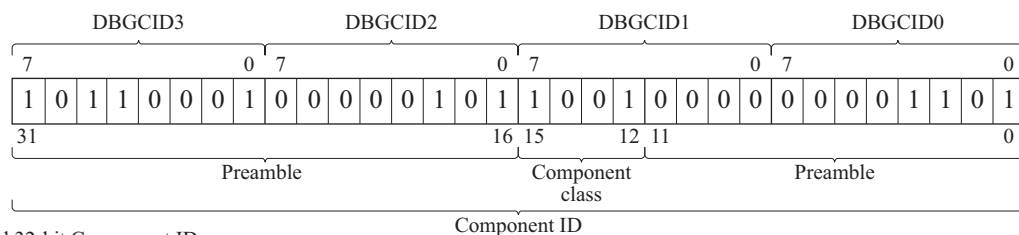

Figure C10-3 Mapping between Debug Component ID Registers and the 32-bit Component ID value

The following subsections describe the formats of each of the Debug Component ID Registers.

DBGCID0

DBGCID0 is debug register 1020 at offset 0xFF0. Its format is:

Bits [31:8] Reserved, RAZ.

Preamble byte 0, bits [7:0]

This byte has the value 0x0D.

DBGCID1

DBGCID1 is debug register 1021 at offset 0xFF4. Its format is:

Bits [31:8] Reserved, RAZ.

Component class, bits [7:4]

This field has the value 0x9, indicating an ARM Debug component.

Preamble, bits [3:0]

This field has the value 0x0.

DBGCID2

DBGCID2 is debug register 1022 at offset 0xFF8. Its format is:

Bits [31:8] Reserved, RAZ.

Preamble byte 2, bits [7:0]

This field has the value 0x05.

DBGCID3

DBGCID3 is debug register 1023 at offset 0xFFC. Its format is:

Bits [31:8] Reserved, RAZ.

Preamble byte 3, bits [7:0]

This field has the value 0xB1.

C10.9 Performance monitor registers

v6 Debug and v6.1 Debug

These registers are not defined in v6 Debug and v6.1 Debug.

v7 Debug The performance monitors are an optional feature in v7 Debug. If implemented, they are registers in CP15 c9, see *CP15 c9 register map* on page C9-10.

The following subsections describe the performance monitor registers:

- *c9, Performance Monitor Control Register (PMCR)*
- *c9, Count Enable Set Register (PMCNTENSET)* on page C10-108
- *c9, Count Enable Clear Register (PMCNTENCLR)* on page C10-109
- *c9, Overflow Flag Status Register (PMOVSr)* on page C10-110
- *c9, Software Increment Register (PMSWINC)* on page C10-112
- *c9, Event Counter Selection Register (PMSELR)* on page C10-113
- *c9, Cycle Count Register (PMCCNTR)* on page C10-114
- *c9, Event Type Select Register (PMXEVTYPER)* on page C10-115
- *c9, Event Count Register (PMXEVCNTR)* on page C10-116
- *c9, User Enable Register (PMUSERENR)* on page C10-117
- *c9, Interrupt Enable Set Register (PMINTENSET)* on page C10-118
- *c9, Interrupt Enable Clear Register (PMINTENCLR)* on page C10-119.

C10.9.1 c9, Performance Monitor Control Register (PMCR)

The Performance Monitor Control Register, PMCR:

- provides details of the performance monitor implementation, including the number of counters implemented
- configures and controls the counters.

The PMCR:

- is a 32-bit read/write CP15 register, with more restricted access to some bits
- is accessible in:
 - privileged modes
 - User mode only when the PMUSERENR.EN bit is set to 1
- when the Security Extensions are implemented, is a Common register
- is accessed using an MRC or MCR command with <CRn> set to c9, <opc1> set to 0, <CRm> set to c12, and <opc2> set to 0
- has defined core logic reset values for its read/write bits.

The format of the PMCR is:

31	24 23	16 15	11 10	6 5 4 3 2 1 0
IMP	IDCODE	N	UNK/SBZP	DP X D C P E

IMP, bits [31:24]

Implementer code. This is a read-only field with an IMPLEMENTATION DEFINED value.

The Implementer codes are allocated by ARM. Values have the same interpretation as bits [31:24] of the CP15 Main ID Register, see:

- *c0*, Main ID Register (MIDR) on page B3-81 for a VMSA implementation
- *c0*, Main ID Register (MIDR) on page B4-32 for a PMSA implementation.

IDCODE, bits [23:16]

Identification code. This is a read-only field with an IMPLEMENTATION DEFINED value.

Each implementer must maintain a list of identification codes that is specific to the implementer. A specific implementation is identified by the combination of the implementer code and the identification code.

N, bits [15:11]

Number of event counters. This is a read-only field with an IMPLEMENTATION DEFINED value that indicates the number of counters implemented.

The value of this field is the number of counters implemented, from 0b00000 for no counters to 0b11111 for 31 counters.

An implementation can implement only the Clock Counter (PMCCNTR) Register. This is indicated by a value of 0b00000 for the N field.

Bits [10:6] Reserved, UNK/SBZP.

DP, bit [5] Disable PMCCNTR when prohibited. The possible values of this bit are:

- 0** Count is enabled in prohibited regions
- 1** Count is disabled in prohibited regions.

Prohibited regions are defined as regions where event counting would be prohibited. For example, if non-invasive debug is disabled in all Secure modes, the Secure state is a prohibited region. For details of non-invasive debug authentication see Chapter C7 *Non-invasive Debug Authentication*.

———— **Note** —————

This bit permits a Non-secure process to discard cycle counts that might be accumulated during periods when the other counts are prohibited because of security prohibitions. It is not a control to enhance security. The function of this bit is to avoid corruption of the count. See also *Interaction with Security Extensions* on page C9-7.

—————

This is a read/write bit. Its core logic reset value is 0.

- X, bit [4]** Export enable. The possible values of this bit are:
- 0** Export of events is disabled
 - 1** Export of events is enabled.
- This bit is used to permit events to be exported to another debug device, such as a trace macrocell, over an event bus. If the implementation does not include such an event bus, this bit is RAZ/WI.
- This bit does not affect the generation of performance monitor interrupts, that can be implemented as a signal exported from the processor to an interrupt controller.
- This is a read/write bit. Its core logic reset value is 0.
- D, bit [3]** Clock divider. The possible values of this bit are:
- 0** When enabled, PMCCNTR counts every clock cycle
 - 1** When enabled, PMCCNTR counts once every 64 clock cycles.
- This is a read/write bit. Its core logic reset value is 0.
- C, bit [2]** Clock counter reset. This is a write-only bit. The effects of writing to this bit are:
- 0** No action
 - 1** Reset PMCCNTR to zero.
- **Note** —————
- Resetting PMCCNTR does not clear the PMCCNTR overflow flag to 0. For details see *c9, Overflow Flag Status Register (PMOVSr)* on page C10-110.
-
- This bit is always RAZ.
- P, bit [1]** Event counter reset. This is a write-only bit. The effects of writing to this bit are:
- 0** No action
 - 1** Reset all event counters, not including PMCCNTR, to zero.
- **Note** —————
- Resetting the event counters does not clear any overflow flags to 0. For details see *c9, Overflow Flag Status Register (PMOVSr)* on page C10-110.
-
- This bit is always RAZ.
- E, bit [0]** Enable. The possible values of this bit are:
- 0** All counters, including PMCCNTR, are disabled
 - 1** All counters are enabled.
- Performance monitor overflow IRQs are only signaled when the enable bit is set to 1.
- This is a read/write bit. Its core logic reset value is 0.

C10.9.2 c9, Count Enable Set Register (PMCNTENSET)

The Count Enable Set Register, PMCNTENSET, is used to enable:

- the Cycle Count Register, PMCCNTR
- any implemented event counters, PMNx.

Reading the PMCNTENSET Register shows which counters are enabled. Counters are disabled using the Count Enable Clear Register, see *c9, Count Enable Clear Register (PMCNTENCLR)* on page C10-109.

The PMCNTENSET Register is:

- a 32-bit read/write CP15 register:
 - reading the register shows which counters are enabled
 - writing a 1 to a bit of the register enables the corresponding counter
 - writing a 0 to a bit of the register has no effect
- accessible in:
 - privileged modes
 - User mode only when the PMUSERENR.EN bit is set to 1
- accessed using an MRC or MCR command with <CRn> set to c9, <opc1> set to 0, <CRm> set to c12, and <opc2> set to 1.

The format of the PMCNTENSET Register is:

31	30		N	N-1		0
C	RAZ/WI	Event counter enable bits, Px, for x = 0 to (N-1)				

Note

In the description of the PMCNTENSET Register:

- N is the number of event counters implemented, as defined by the PMCR.N field, see *c9, Performance Monitor Control Register (PMCR)* on page C10-105
- x refers to a single event counter, and takes values from 0 to (N-1).

C, bit [31] PMCCNTR enable bit.

See Table C10-25 on page C10-109 for the behavior of this bit on reads and writes.

Bits [30:N] RAZ/WI.

Px, bit [x], for x = 0 to (N-1)

Event counter x, PMNx, enable bit.

Table C10-25 shows the behavior of this bit on reads and writes.

Table C10-25 Read and write bit values for the PMCNTENSET Register

Value	Meaning on read	Action on write
0	Counter disabled	No action, write is ignored
1	Counter enabled	Enable counter

The contents of the PMCNTENSET Register are UNKNOWN on a core logic reset.

C10.9.3 c9, Count Enable Clear Register (PMCNTENCLR)

The Count Enable Clear Register, PMCNTENCLR, is used to disable:

- the Cycle Count Register, PMCCNTR
- any implemented event counters, PMNx.

Reading the PMCNTENCLR Register shows which counters are enabled. Counters are enabled using the Count Enable Set Register, see *c9, Count Enable Set Register (PMCNTENSET)* on page C10-108.

The PMCNTENCLR Register is:

- a 32-bit read/write CP15 register:
 - reading the register shows which counters are enabled
 - writing a 1 to a bit of the register disables the corresponding counter
 - writing a 0 to a bit of the register has no effect
- accessible in:
 - privileged modes
 - User mode only when the PMUSERENR.EN bit is set to 1
- when the Security Extensions are implemented, a Common register
- accessed using an MRC or MCR command with <CRn> set to c9, <opc1> set to 0, <CRm> set to c12, and <opc2> set to 2.

The format of the PMCNTENCLR Register is:

31	30	N	N-1	0
C	RAZ/WI	Event counter disable bits, Px, for x = 0 to (N-1)		

Note

In the description of the PMCNTENCLR Register, N and x have the meanings used in the description of the PMCNTENSET Register, see *c9, Count Enable Set Register (PMCNTENSET)* on page C10-108.

C, bit [31] PMCCNTR disable bit.

See Table C10-26 on page C10-110 for the behavior of this bit on reads and writes.

Bits [30:N] RAZ/WI.

Px, bit [x], for x = 0 to (N-1)

Event counter *x*, PMN_{*x*}, disable bit.

Table C10-26 shows the behavior of this bit on reads and writes.

Table C10-26 Read and write bit values for the PMCNTENCLR Register

Value	Meaning on read	Action on write
0	Counter disabled	No action, write is ignored
1	Counter enabled	Disable counter

The contents of the PMCNTENCLR Register are UNKNOWN on a core logic reset.

Note

The PMCR.E Enable bit can be used to override the settings in this register and disable all counters including PMCCNTR, see *c9, Performance Monitor Control Register (PMCR)* on page C10-105. The counter enable register retains its value when the Enable bit is 0, even though its settings are ignored.

C10.9.4 c9, Overflow Flag Status Register (PMOVSr)

The Overflow Flag Status Register, PMOVSr, holds the state of the overflow flags for:

- the Cycle Count Register, PMCCNTR
- each of the implemented event counters, PMN_{*x*}.

To clear those flags you must write to the PMOVSr.

The PMOVSr is:

- a 32-bit read/write CP15 register:
 - reading the register shows the state of the overflow flags
 - writing a 1 to a bit of the register clears the corresponding flag
 - writing a 0 to a bit of the register has no effect
- accessible in:
 - privileged modes
 - User mode only when the PMUSERENR.EN bit is set to 1
- when the Security Extensions are implemented, a Common register
- accessed using an MRC or MCR command with <CRn> set to c9, <opc1> set to 0, <CRm> set to c12, and <opc2> set to 3.

The format of the PMOVSR is:

31	30	N	N-1	0
C	RAZ/WI	Event counter overflow flags, Px, for x = 0 to (N-1)		

———— **Note** ————

In the description of the PMOVSR, N and x have the meanings used in the description of the PMCNTENSET Register, see *c9, Count Enable Set Register (PMCNTENSET)* on page C10-108.

C, bit [31] PMCCNTR overflow flag.

Table C10-27 shows the behavior of this bit on reads and writes.

Bits [30:N] RAZ/WI.

Px, bit [x], for x = 0 to (N-1)

Event counter x, PMNx, overflow flag.

Table C10-27 shows the behavior of this bit on reads and writes.

Table C10-27 Read and write bit values for the PMOVSR

Value	Meaning on read	Action on write
0	Counter has not overflowed	No action, write is ignored
1	Counter has overflowed	Clear flag to 0

The contents of the PMOVSR are UNKNOWN on a core logic reset.

———— **Note** ————

The overflow flag values for individual counters are retained until cleared to 0 by a write to the PMOVSR or processor reset, even if the counter is later disabled by writing to the PMCNTENCLR register or through the PMCR.E Enable bit. The overflow flags are also not cleared to 0 when the counters are reset through the Event counter reset or Clock counter reset bits in the PMCR.

C10.9.5 c9, Software Increment Register (PMSWINC)

The Software Increment Register, PMSWINC, increments a counter that is configured to count the Software count event, event $0x00$.

The PMSWINC Register is:

- a 32-bit write-only CP15 register
- accessible in:
 - privileged modes
 - User mode only when the PMUSERENR.EN bit is set to 1
- when the Security Extensions are implemented, a Common register
- accessed using an MCR command with <CRn> set to c9, <opc1> set to 0, <CRm> set to c12, and <opc2> set to 4.

The format of the PMSWINC Register is:

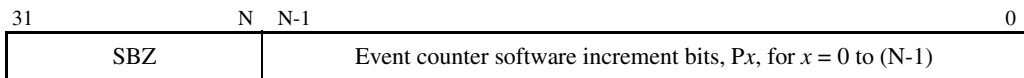

———— **Note** ————

In the description of the PMSWINC Register, N and x have the meanings used in the description of the PMCNTENSET Register, see *c9, Count Enable Set Register (PMCNTENSET)* on page C10-108.

Bits [31:N] Reserved, SBZ.

P_x , bit $[x]$, for $x = 0$ to $(N-1)$

Event counter x , PMN_x , software increment bit. This is a write-only bit. The effects of writing to this bit are:

- 0** No action, the write is ignored
- 1, if PMN_x is configured to count the Software count event**
Increment PMN_x Register by 1
- 1, if PMN_x is not configured to count the Software count event**
UNPREDICTABLE.

C10.9.6 c9, Event Counter Selection Register (PMSELR)

The Event Counter Selection Register, PMSELR, selects the current event counter, PMN_x. When a particular event counter is selected:

- the PMXEVTYPER can be used to set the event that increments that counter, or to read the current configuration, see *c9, Event Type Select Register (PMXEVTYPER)* on page C10-115
- the PMXEVCNTR can be used to read the current value of that counter, or to write a value to that counter, see *c9, Event Count Register (PMXEVCNTR)* on page C10-116

The PMSELR is:

- a 32-bit read/write CP15 register
- accessible in:
 - privileged modes
 - User mode only when the PMUSERENR.EN bit is set to 1
- when the Security Extensions are implemented, a Common register
- accessed using an MRC or MCR command with <CRn> set to c9, <opc1> set to 0, <CRm> set to c12, and <opc2> set to 5.

The format of the PMSELR is:

31	5	4	0
Reserved, UNK/SBZP		SEL	

Bits [31:5] Reserved, UNK/SBZP.

SEL, bits [4:0]

Selection value of the current event counter, PMN_x, where *x* is the value held in this field. This field can take any value from 0 (0b00000) to 30 (0b11110).

If this field is set to a value greater than or equal to the number of implemented counters the results are UNPREDICTABLE. The number of implemented counters is defined by the PMCR.N field, see *c9, Performance Monitor Control Register (PMCR)* on page C10-105.

The value of 0b11111 is Reserved and must not be used.

The contents of the PMSELR are UNKNOWN on a core logic reset.

The SEL field identifies which event counter, PMN_{SEL}, is accessed by PMXEVTYPER and PMXEVCNTR, see *c9, Event Type Select Register (PMXEVTYPER)* on page C10-115 and *c9, Event Count Register (PMXEVCNTR)* on page C10-116.

C10.9.7 c9, Cycle Count Register (PMCCNTR)

The Cycle Count Register, PMCCNTR, counts processor clock cycles. Depending on the value of the PMCR.D bit, PMCCNTR increments either on every processor clock cycle or on every 64th processor clock cycle. See *c9, Performance Monitor Control Register (PMCR)* on page C10-105.

The PMCCNTR is:

- a 32-bit read/write CP15 register
- accessible in:
 - privileged modes
 - User mode only when the PMUSERENR.EN bit is set to 1
- when the Security Extensions are implemented, a Common register
- accessed using an MRC or MCR command with <CRn> set to c9, <opc1> set to 0, <CRm> set to c13, and <opc2> set to 0.

The format of the PMCCNTR is:



CCNT, bits [31:0]

Cycle count. Depending on the value of the PMCR.D bit, this field increments either:

- every processor clock cycle
- every 64th processor clock cycle.

The contents of the PMCCNTR are UNKNOWN on a core logic reset.

The PMCCNTR.CCNT value can be reset to zero by writing a 1 to the PMCR.C bit, see *c9, Performance Monitor Control Register (PMCR)* on page C10-105.

C10.9.8 c9, Event Type Select Register (PMXEVTYPER)

The Event Type Select Register, PMXEVTYPER, configures which event increments the current event counter, PMN_x, or to read the current configuration. PMSELR selects the current event counter, see *c9, Event Counter Selection Register (PMSELR)* on page C10-113.

The PMXEVTYPER is:

- a 32-bit read/write CP15 register
- accessible in:
 - privileged modes
 - User mode only when the PMUSERENR.EN bit is set to 1
- when the Security Extensions are implemented, a Common register
- accessed using an MRC or MCR command with <CRn> set to c9, <opc1> set to 0, <CRm> set to c13, and <opc2> set to 1.

The format of the PMXEVTYPER is:

31	8	7	0
Reserved, UNK/SBZP		evtCount	

Bits [31:8] Reserved, UNK/SBZP.

evtCount, bits [7:0]

Event to count. The Event number of the event that is counted by the current event counter, PMN_x. For more information, see *Event numbers*.

The contents of each of the Event Type Select Registers are UNKNOWN on a core logic reset.

Event numbers

Event numbers are used in the PMXEVTYPER to determine the event that causes an event counter to increment. These event numbers are split into two ranges:

0x00-0x3F Common features. Reserved for the specified events. When an ARMv7 processor supports monitoring of an event that is assigned a number in this range, if possible it must use that number for the event. Unassigned values are reserved and might be used to define additional common events in future editions of this manual.

0x40-0xFF IMPLEMENTATION DEFINED features.

For more information, including the assigned values in the common features range, see *Event numbers* on page C9-13.

C10.9.9 c9, Event Count Register (PMXEVNTR)

The Event Count Register, PMXEVNTR, is used to read or write the value of the current event counter, PMNx. PMSELR selects the current event counter, see *c9, Event Counter Selection Register (PMSELR)* on page C10-113.

The PMXEVNTR is:

- a 32-bit read/write CP15 register
- accessible in:
 - privileged modes
 - User mode only when the PMUSERENR.EN bit is set to 1
- when the Security Extensions are implemented, a Common register
- accessed using an MRC or MCR command with <CRn> set to c9, <opc1> set to 0, <CRm> set to c13, and <opc2> set to 2.

The format of the PMXEVNTR is:

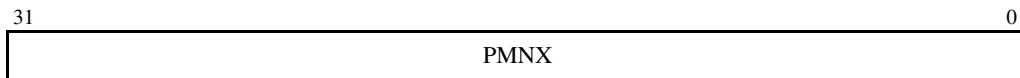

PMNX, bits [31:0]

Value of the current event counter, PMNx.

A read of the PMXEVNTR always returns the current value of the register.

The contents of each of the Event Count Registers are UNKNOWN on a core logic reset.

———— **Note** ————

You can write to the PMXEVNTR even when the counter is disabled. This is true regardless of why the counter is disabled, which can be any of:

- because 1 has been written to the appropriate bit in the PMCNTENCLR
- because the PMCR.E bit is set to 0
- by the non-invasive debug authentication.

C10.9.10 c9, User Enable Register (PMUSERENR)

The User Enable Register, PMUSERENR, enables or disables User mode access to the performance monitors.

The PMUSERENR is:

- a 32-bit read/write CP15 register, with access that depends on the current mode:
 - in a privileged mode, the PMUSERENR is a read/write register
 - in User mode, the PMUSERENR is a read-only register
- when the Security Extensions are implemented, a Common register
- accessed using an MRC or MCR command with <CRn> set to c9, <opc1> set to 0, <CRm> set to c14, and <opc2> set to 0.

The format of the PMUSERENR is:

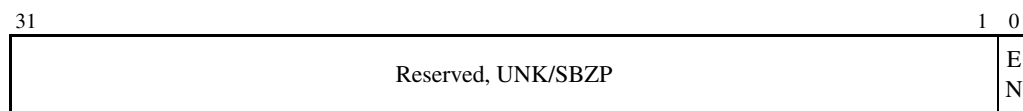

Bits [31:1] Reserved, UNK/SBZP.

EN, bit [0] User mode access enable bit. The possible values of this bit are:

- 0** User mode access to performance monitors disabled
- 1** User mode access to performance monitors enabled.

Some MCR and MRC instructions used to access the performance monitors are UNDEFINED in User mode when User mode access to the performance monitors is disabled. For more information, see *Access permissions* on page C9-12.

The PMUSERENR.EN bit is set to 0 on a core logic reset.

C10.9.11 c9, Interrupt Enable Set Register (PMINTENSET)

The Interrupt Enable Set Register, PMINTENSET, enables the generation of interrupt requests on overflows from:

- the Cycle Count Register, PMCCNTR
- each implemented event counter, PMNx.

Reading the PMINTENSET Register shows which overflow interrupts are enabled. Counter overflow interrupts must be disabled using the PMINTENCLR Register, see *c9, Interrupt Enable Clear Register (PMINTENCLR)* on page C10-119.

The PMINTENSET Register is:

- A 32-bit read/write CP15 register:
 - reading the register shows which overflow interrupts are enabled
 - writing a 1 to a bit of the register enables the corresponding overflow interrupt
 - writing a 0 to a bit of the register has no effect.
- Accessible only in privileged modes.

The instructions that access the PMINTENSET Register are always UNDEFINED in User mode, even if the PMUSERENR.EN flag is set to 1, see *c9, User Enable Register (PMUSERENR)* on page C10-117.
- When the Security Extensions are implemented, a Common register.
- Accessed using an MRC or MCR command with <CRn> set to c9, <opc1> set to 0, <CRm> set to c14, and <opc2> set to 1.

The format of the PMINTENSET Register is:

31	30	N	N-1	0
C	RAZ/WI	Event counter overflow interrupt enable bits, Px, for x = 0 to (N-1)		

Note

In the description of the PMINTENSET Register, N and x have the meanings used in the description of the PMCNTENSET Register, see *c9, Count Enable Set Register (PMCNTENSET)* on page C10-108.

- C, bit [31]** PMCCNTR overflow interrupt enable bit.
See Table C10-28 on page C10-119 for the behavior of this bit on reads and writes.
- Bits [30:N]** RAZ/WI.
- Px, bit [x], for x = 0 to (N-1)**
Event counter x, PMNx, overflow interrupt enable bit.

Table C10-28 shows the behavior of this bit on reads and writes.

Table C10-28 Read and write bit values for the PMINTENSET Register

Value	Meaning on read	Action on write
0	Interrupt disabled	No action, write is ignored
1	Interrupt enabled	Enable interrupt

The contents of the PMINTENSET Register are UNKNOWN on a core logic reset. To avoid spurious interrupts being generated, software must set the interrupt enable values before enabling any of the counters. Interrupts are not signaled if the PMCR.E Enable bit is set to 0.

When an interrupt is signaled, it can be removed by clearing the overflow flag for the counter in the PMOVS Register, see *c9, Overflow Flag Status Register (PMOVS)* on page C10-110.

———— **Note** —————

ARM expects that the interrupt request that can be generated on a counter overflow is also exported from the processor, meaning it can be factored into a system interrupt controller if applicable. This means that normally the system will have more levels of control of the interrupt generated.

C10.9.12 c9, Interrupt Enable Clear Register (PMINTENCLR)

The Interrupt Enable Clear Register, PMINTENCLR, disables the generation of interrupt requests on overflows from:

- the Cycle Count Register, PMCCNTR
- each implemented event counter, PMNx.

Reading the PMINTENCLR Register shows which overflow interrupts are enabled. Counter overflow interrupts must be enabled using the PMINTENSET Register, see *c9, Interrupt Enable Set Register (PMINTENSET)* on page C10-118.

The PMINTENCLR Register is:

- A 32-bit read/write CP15 register:
 - reading the register shows which overflow interrupts are enabled
 - writing a 1 to a bit of the register disables the corresponding overflow interrupt
 - writing a 0 to a bit of the register has no effect.
- Accessible only in privileged modes.

The instructions that access the PMINTENCLR Register are always UNDEFINED in User mode, even if the PMUSERENR.EN flag is set to 1, see *c9, User Enable Register (PMUSERENR)* on page C10-117.

- When the Security Extensions are implemented, a Common register.
- Accessed using an MRC or MCR command with <CRn> set to c9, <opc1> set to 0, <CRm> set to c14, and <opc2> set to 2.

Part D

Appendices

Appendix A

Recommended External Debug Interface

This chapter describes the recommended external debug interface. It contains the following sections:

- *System integration signals* on page AppxA-2
- *Recommended debug slave port* on page AppxA-13.

———— **Note** —————

This recommended external debug interface specification is not part of the ARM architecture specification. Implementers and users of the ARMv7 architecture must not consider this appendix as a requirement of the architecture. It is included as an appendix to this manual only:

- as reference material for users of ARM products that implement this interface
- as an example of how an external debug interface might be implemented.

The inclusion of this appendix is no indication of whether any ARM products might, or might not, implement this external debug interface. For details of the implemented external debug interface you must always see the appropriate product documentation.

A.1 System integration signals

Table A-1 shows the signals recommended in v7 Debug.

Table A-1 Miscellaneous debug signals

Name	Direction	Versions	Description	Section
DBGEN	In	v6, v6.1, v7	Debug Enable	<i>Authentication signals on page AppxA-3</i>
NIDEN	In	v6, v6.1: optional v7: required	Non-Invasive Debug Enable	
SPIDEN	In	v6.1, v7	Secure Privileged Invasive Debug Enable	
SPNIDEN	In	v6.1, v7	Secure Privileged Non-Invasive Debug Enable	
DBGRESTART	In	v7 only	External restart request	<i>Run-control and cross-triggering signals on page AppxA-5</i>
DBGRESTARTED	In	v7 only	Handshake for DBGRESTART	
DBGTRIGGER	Out	v7 only, optional	Debug Acknowledge signal	
EDBGRQ	In	v6, v6.1, v7	External Debug Request	
DBGACK	Out	v6, v6.1, v7	Debug Acknowledge signal	<i>DBGACK and DBGCPUDONE on page AppxA-7</i>
DBGCPUDONE	Out	v7 only, optional	Debug Acknowledge signal	
COMMRX	Out	v6, v6.1, v7	DBGDTRRX full signal	<i>COMMRX and COMMTX on page AppxA-9</i>
COMMTX	Out	v6, v6.1, v7	DBGDTRTX empty signal	
DBGOSLOCKINIT	In	v7 only	Initialize OS Lock on reset	<i>DBGOSLOCKINIT on page AppxA-9</i>
DBGNOPWRDWN	Out	v6, v6.1: optional v7: required	No power-down request signal	<i>DBGNOPWRDWN on page AppxA-9</i>
DBGPWRDUP	In	v7 only	Processor powered up	<i>DBGPWRDUP on page AppxA-10</i>

Table A-1 Miscellaneous debug signals (continued)

Name	Direction	Versions	Description	Section
DBGROMADDR[31:12]	In	v7 only	ROM Table physical address	<i>DBGROMADDR</i> and <i>DBGROMADDRV</i> on page AppxA-10
DBGROMADDRV	In	v7 only	ROM Table physical address valid	
DBGSELFADDR[31:12]	In	v7 only	Debug self-address offset	<i>DBGSELFADDR</i> and <i>DBGSELFADDRV</i> on page AppxA-10
DBGSELFADDRV	In	v7 only	Debug self-address offset valid	
DBGSWENABLE	In	v7 only	Debug software access enable	<i>DBGSWENABLE</i> on page AppxA-11
PRESETDBGn	In	v7 only	Debug logic reset	<i>PRESETDBGn</i> on page AppxA-12

A.1.1 Authentication signals

DBGEN, **NIDEN**, **SPIDEN** and **SPNIDEN** are the authentication signals.

NIDEN and **SPNIDEN** can be omitted if no non-invasive debug features are implemented.

SPIDEN and **SPNIDEN** can be omitted if Security Extensions are not implemented.

When **DBGEN** is LOW, indicating that debug is disabled:

- Halting debug events are ignored
- except for ignoring Halting debug events, the processor behaves as if `DBGDSCR[15:14] == 0b00`, meaning that Monitor debug-mode and Halting debug-mode are both disabled. For more information, see *Debug Status and Control Register (DBGDSCR)* on page C10-10.

For details of how these signals control enabling of invasive and non-invasive debug see Chapter C2 *Invasive Debug Authentication* and Chapter C7 *Non-invasive Debug Authentication*.

————— Note —————

The v7 Debug architecture authentication signal interface described here is compatible with the CoreSight architecture requirements for the authentication interface of a debug component. However the CoreSight architecture places additional requirements on other components in the system. For more information, see the *CoreSight Architecture Specification*.

SPIDEN also controls permissions in Debug state. For details see *Privilege in Debug state* on page C5-13.

See also *Authentication Status Register (DBGAUTHSTATUS)* on page C10-96.

Changing the authentication signals

In v6.1 Debug and v7 Debug, the **NIDEN**, **DBGGEN**, **SPIDEN**, and **SPNIDEN** authentication signals can be controlled dynamically, meaning that they might change while the processor is running, or while the processor is in Debug state.

———— **Note** ————

In v6 Debug **DBGGEN** is a static signal and can be changed only while the processor is in reset.

Normally, these signals are driven by the system, meaning that they are driven by a peripheral connected to the ARM processor. If the software running on the ARM processor has to change any of these signals it must follow this procedure:

1. Execute an implementation specific sequence of instructions to change the signal value. For example, this might be an instruction to write a value to a control register in a system peripheral.
2. If step 1 involves any memory operation, perform a Data Synchronization Barrier (DSB).
3. Poll the debug registers to check the signal values seen by the processor. This is required because the processor might not see the signal change until several cycles after the DSB completes.
4. Perform an Instruction Synchronization Barrier (ISB), exception entry or exception return.

The software cannot perform debug or analysis operations that rely on the new value until this procedure has been completed. The same rules apply for instructions executed through the DBGITR while in Debug state. The processor view of the authentication signals can be polled through DBGDSCR[17:16] and, in v7 Debug, the DBGAUTHSTATUS register.

———— **Note** ————

Exceptionally, the processor might be in Debug state even though the mode, security state and authentication signal settings are such that, in Non-debug state, debug events would be ignored. This can occur because:

- it is UNPREDICTABLE whether the behavior of debug events that are generated between a change in the authentication signals and the next Instruction Synchronization Barrier, exception entry or exception return follow the behavior of the old or new settings
- it is possible to change the authentication signals while the processor is in Debug state.

See also *Generation of debug events* on page C3-40 and *Altering CPSR privileged bits in Debug state* on page C5-14.

A.1.2 Run-control and cross-triggering signals

ARM recommends implementation of the run-control and cross-triggering signals **EDBGRQ**, **DBGTRIGGER**, **DBGRESTART**, and **DBGRESTARTED**. These signals are particularly useful in a multiprocessor system, because using them:

- A debugger can signal a group of processors to enter Debug state.
- A debugger can signal a group of processors to leave Debug state.
- A system component can signal a group of processors to enter Debug state when any one of them enters Debug state because of a debug event on that processor. This is known as *cross-triggering*.

If you implement the recommended signalling in your system hardware, this signalling means all of the processors in the group enter or leave Debug state nearly simultaneously.

These signals can also be used in a uniprocessor implementation. For example, debug events not defined by the debug architecture might be generated externally to the processor. When one of these events occurs the external system can use these signals to cause the processor to enter Debug state. A trace macrocell might use these signals in this way.

Contact ARM for details of a recommended *Embedded Cross Trigger* (ECT) peripheral that you can use in a multiprocessor system to implement this signalling.

The following subsections describe each of the recommended signals:

- *EDBGRQ*
- *DBGTRIGGER* on page AppxA-6
- *DBGRESTART and DBGRESTARTED* on page AppxA-6.

EDBGRQ

EDBGRQ is the recommended implementation of the External Debug Request mechanism, see *Halting debug events* on page C3-38.

EDBGRQ is active-HIGH.

Once **EDBGRQ** is asserted it must be held HIGH until it is acknowledged:

- An implementation can use either **DBGACK** or **DBGTRIGGER** to acknowledge **EDBGRQ**, see:
 - *DBGACK and DBGCPUDONE* on page AppxA-7
 - *DBGTRIGGER* on page AppxA-6.
- Alternatively, debugger software might use an IMPLEMENTATION DEFINED method to acknowledge **EDBGRQ**. For example, once the processor has entered Debug state the debugger might reprogram the peripheral that is driving **EDBGRQ**.

DBGTRIGGER

The processor asserts **DBGTRIGGER** to indicate that it is committed to entering Debug state. Therefore, the system can use **DBGTRIGGER** to acknowledge **EDBGRQ**. See Chapter C5 *Debug State* for the definition of Debug state.

DBGTRIGGER is active-HIGH.

The processor must assert **DBGTRIGGER** as early as possible, so that the system can use its rising edge to signal to other devices that the processor is entering Debug state. **DBGTRIGGER** can be used for cross-triggering. For example, in a multiprocessor system, when one processor halts, the **DBGTRIGGER** signal from that processor can be used to generate an External Debug Request for the other processors.

See *DBGACK* and *DBGCPUDONE* on page AppxA-7 for details of the recommended External Debug Request handshaking between **EDBGRQ** and **DBGTRIGGER**.

In addition, the processor asserts **DBGTRIGGER** whenever the *DBGDSCR.DBGack* bit is set to 1, see *Debug Status and Control Register (DBGDSCR)* on page C10-10.

If the *DBGDSCR.DBGack* bit is 0, the processor deasserts **DBGTRIGGER** on exit from Debug state.

———— Note ————

Setting *DBGDSCR.DBGack* to 1 takes no account of the **DBGEN** and **SPIDEN** signals. Setting *DBGDSCR.DBGack* to 1 asserts **DBGTRIGGER** regardless of the security settings.

A v7 Debug implementation of these recommendations might not implement **DBGTRIGGER** if it would have identical behavior to **DBGACK**.

Before v7 Debug, **DBGTRIGGER** is not part of the recommended external debug interface.

DBGRESTART and DBGRESTARTED

DBGRESTART is the recommended implementation of the External Restart request, see *Leaving Debug state* on page C5-28. **DBGRESTARTED** is a handshake signal for **DBGRESTART**.

DBGRESTART and **DBGRESTARTED** are active-HIGH.

Once **DBGRESTART** is asserted, it must be held HIGH until **DBGRESTARTED** is deasserted. The processor ignores **DBGRESTART** if it is not in Debug state.

Figure A-1 on page AppxA-7 shows the four-phase handshake of **DBGRESTART** and **DBGRESTARTED**. It is diagrammatic only, and does not imply any timings.

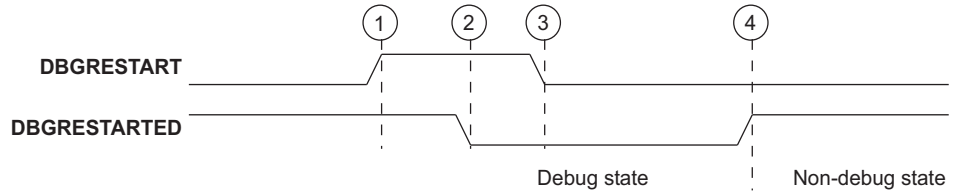

Figure A-1 DBGRESTART / DBGRESTARTED handshake

The numbers in Figure A-1 have the following meanings:

1. If **DBGRESTARTED** is asserted HIGH the peripheral asserts **DBGRESTART** HIGH and waits for **DBGRESTARTED** to go LOW
2. The processor drives **DBGRESTARTED** LOW to deassert the signal and waits for **DBGRESTART** to go LOW
3. The peripheral drives **DBGRESTART** LOW to deassert the signal. This event indicates to the processor that it can start the transition from Debug state to Non-debug state.
4. The processor leaves Debug state and asserts **DBGRESTARTED** HIGH.

In the process of leaving Debug state the processor normally deasserts the **DBGACK**, **DBGTRIGGER**, and **DBGCPUDONE** signals. It is IMPLEMENTATION DEFINED when this change occurs relative to the changes in **DBGRESTART** and **DBGRESTARTED**.

A.1.3 **DBGACK** and **DBGCPUDONE**

DBGACK and **DBGCPUDONE** are active-HIGH.

The processor asserts **DBGACK** to indicate that it is in Debug state. Therefore, the system can use **DBGACK** as a handshake for **EDBGRQ**, instead of using **DBGTRIGGER**.

In v6 Debug and v6.1 Debug, the system can use **DBGACK** for cross-triggering.

The processor asserts **DBGCPUDONE** only after it has completed all Non-debug state memory accesses. Therefore the system can use **DBGCPUDONE** as an indicator that all memory accesses issued by the processor result from operations performed by a debugger.

Figure A-2 on page AppxA-8 shows the signalling sequence for entry to Debug state. It is diagrammatic only, and does not imply any timings.

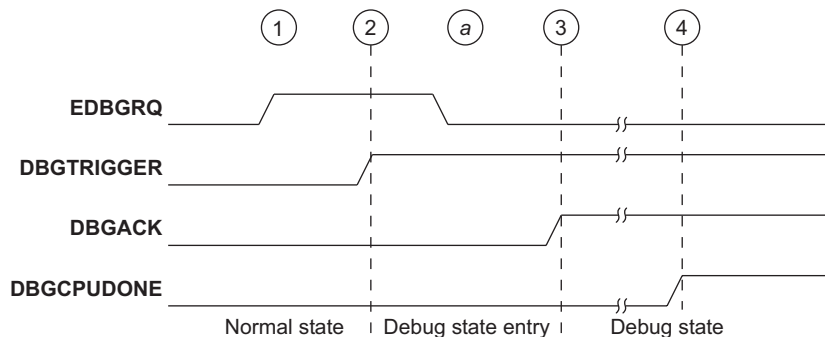

See the text about the ordering of transition *a*.

Figure A-2 Signalling for Debug state entry on an External Debug Request

In Figure A-2 these events must occur in order:

- 1 The peripheral asserts **EDBGRQ** and waits for it to be acknowledged.
- 2 The processor takes the debug event and starts the Debug state entry sequence. The processor asserts **DBGTRIGGER**.
- 3 The processor completes the Debug state entry sequence and asserts **DBGACK**.
- 4 The processor completes all Non-debug state memory accesses and asserts **DBGCPUDONE**. It might do this only after intervention by an external debugger, see *Asynchronous aborts and entry to Debug state* on page C5-5.

Event *a*, the peripheral deasserting **EDBGRQ**, can occur at any time after the assertion of **EDBGRQ** is acknowledged. In the example shown in Figure A-2, the system is using **DBGTRIGGER** to acknowledge **EDBGRQ**, and therefore event *a* is not ordered relative to events 3 and 4.

In addition, the processor asserts **DBGCPUDONE** and **DBGACK** when the **DBGDSCR.DBGack** bit is set to 1, see *Debug Status and Control Register (DBGDSCR)* on page C10-10.

If the **DBGDSCR.DBGack** bit is 0, the processor deasserts **DBGCPUDONE** and **DBGACK** on exit from Debug state.

———— **Note** —————

Setting **DBGDSCR.DBGack** to 1 takes no account of the **DBGGEN** and **SPIDEN** signals. Setting **DBGDSCR.DBGack** to 1 asserts **DBGCPUDONE** and **DBGACK** regardless of the security settings.

A v7 Debug implementation of these recommendations might not implement **DBGCPUDONE** if it would have identical behavior to **DBGACK**.

Before v7 Debug, **DBGCPUDONE** was not part of the recommended external debug interface.

A.1.4 COMMRX and COMMTX

COMMRX and **COMMTX** reflect the state of DBGDSCR[30:29] through the external debug interface:

- **COMMTX** is the inverse of DBGDSCR[29], TXfull. The processor is ready to transmit.
- **COMMRX** is equivalent to DBGDSCR[30], RXfull.

See *Debug Status and Control Register (DBGDSCR)* on page C10-10 for descriptions of the TXfull and RXfull bits.

These signals are active HIGH indicators of when the *Debug Communications Channel (DCC)* requires processing by the target system. They permit interrupt-driven communications over the DCC. By connecting these signals to an interrupt controller, software using the DCC can be interrupted whenever there is new data on the channel or when the channel is clear for transmission.

———— **Note** —————

There can be race conditions between reading the DCC flags through a read of DBGDSCRExt and a read of the DBGDTRTXint Register or a write to the DBGDTRRXint Register through the Baseline CP14 interface. However the timing of these signals with respect to the DCC registers must be such that target code executing off an interrupt triggered by either of these signals must be able to write to DBGDTRTXint and read DBGDTRRXint without race conditions.

A.1.5 DBGOSLOCKINIT

DBGOSLOCKINIT is not required in v6 Debug and v6.1 Debug.

In v7 Debug, **DBGOSLOCKINIT** is a configuration signal that determines the state of the OS Lock immediately after a debug registers reset. On a debug registers reset:

- if **DBGOSLOCKINIT** is HIGH then the OS Lock is set from the reset
- if **DBGOSLOCKINIT** is LOW then the OS Lock is clear from the reset.

Normally, **DBGOSLOCKINIT** is tied off LOW.

For a description of debug registers reset see *Recommended reset scheme for v7 Debug* on page C6-16. For details of the OS Lock see *OS Save and Restore registers, v7 Debug only* on page C10-75.

See also *Permissions in relation to locks* on page C6-27.

A.1.6 DBGNOPWRDWN

DBGNOPWRDWN is optional in v6 Debug and v6.1 Debug.

DBGNOPWRDWN is equivalent to the value of bit [0] of the Device Power-Down and Reset Control Register. The processor power controller must work in emulate mode when this signal is HIGH.

For more information, see *Device Power-down and Reset Control Register (DBGPRCR), v7 Debug only* on page C10-31.

A.1.7 **DBGPWRDUP**

DBGPWRDUP is not required in v6 Debug and v6.1 Debug.

DBGPWRDUP is not required in a SinglePower system, that is, it is not required in a design that has only one power domain.

The **DBGPWRDUP** input signal is HIGH when the processor is powered up, and LOW otherwise. The **DBGPWRDUP** signal is reflected in bit [0] of the Device Power-Down and Reset Status Register.

See also *Device Power-down and Reset Status Register (DBGPRSR)*, v7 Debug only on page C10-34 and *Permissions in relation to power-down* on page C6-28.

A.1.8 **DBGROMADDR and DBGROMADDRV**

DBGROMADDR and **DBGROMADDRV** are not required in v6 Debug and v6.1 Debug. They are required in v7 Debug if the memory-mapped interface is implemented.

DBGROMADDR specifies bits [31:12] of the ROM Table table physical address. This is a configuration input. It must be either:

- be a tie-off
- change only while the processor is in reset.

In a system with multiple ROM Tables, this address must be tied off to the top-level ROM Table address.

In a system with no ROM Table this address must be tied off with the physical address where the debug registers are memory-mapped. Debug software can use the debug component identification registers at the end of the 4KB block addressed by **DBGROMADDR** to distinguish a ROM table from a processor.

———— **Note** —————

If the system implements more than one debug component, for example a processor and a trace macrocell, a ROM Table must be provided.

DBGROMADDRV is the valid signal for **DBGROMADDR**. If the address cannot be determined, **DBGROMADDR** must be tied off to zero and **DBGROMADDRV** tied LOW.

The format of ROM Tables is defined in the *ARM Debug Interface v5 Architecture Specification*.

A.1.9 **DBGSELFADDR and DBGSELFADDRV**

DBGSELFADDR and **DBGSELFADDRV** are not required in v6 Debug and v6.1 Debug.

In v7 Debug, **DBGSELFADDR** and **DBGSELFADDRV** are required if the memory-mapped interface is implemented. If **DBGROMADDR** and **DBGROMADDRV** are not implemented, **DBGSELFADDR** and **DBGSELFADDRV** must not be implemented.

DBGSELFADDR specifies bits [31:12] of the two's complement signed offset from the ROM Table physical address to the physical address where the debug registers are Memory-mapped. This is a configuration input. It must either:

- be a tie-off
- change only while the processor is in reset.

If there is no ROM Table, **DBGROMADDR** must be configured as described in the section *DBGROMADDR and DBGROMADDRV* on page AppxA-10, and **DBGSELFADDR** must be tied off to zero with **DBGSELFADDRV** tied HIGH.

DBGSELFADDRV is the valid signal for **DBGSELFADDR**. If the offset cannot be determined, **DBGSELFADDR** must be tied off to zero and **DBGSELFADDRV** tied LOW.

A.1.10 DBGSWENABLE

DBGSWENABLE is not required in v6 Debug and v6.1 Debug.

In v7 Debug, **DBGSWENABLE** is driven by the Debug Access Port. For details see the *ARM Debug Interface v5 Architecture Specification*.

DBGSWENABLE is an active-HIGH signal that must be asserted to enable system access to the debug register file. That is, if deasserted it prevents access through the memory-mapped and Extended CP14 interfaces. This gives the debugger full control over the debug registers in the processor.

When this signal is deasserted by the debugger by a means that is IMPLEMENTATION DEFINED, memory-mapped interface accesses return an error response and most Extended CP14 operations become UNDEFINED instructions. See *CP14 debug registers access permissions* on page C6-36 and *Permission summaries for memory-mapped and external debug interfaces* on page C6-45.

In the ARM Debug Interface v5, **DBGSWENABLE** is asserted by setting the DbgSwEnable control bit in the access port *Control Status Word Register* (CSW) to 1. For the memory-mapped interface, when the DbgSwEnable control bit is set to 0 the generation of slave-generated errors is a function of the ADIV5 Debug Access Port, and therefore the processor ignores the **DBGSWENABLE** signal for the memory-mapped interface. For details see the *ARM Debug Interface v5 Architecture Specification*.

The **DBGSWENABLE** signal has no effect on accesses through the external debug interface.

Normally, the **DBGSWENABLE** signal must be asserted at debug logic reset and deasserted under debugger control.

A.1.11 PRESETDBGn

PRESETDBGn is not required in v6 Debug and v6.1 Debug. The debug logic is only reset on system power-up reset.

The reset signal resets all debug registers. See also *Recommended reset scheme for v7 Debug* on page C6-16.

———— **Note** —————

Do not use the **PRESETDBGn** signal to reset the debug registers if the debug system is connected to a debug monitor that uses the CP14 debug interface.

A.2 Recommended debug slave port

This slave port is not required in v6 Debug and v6.1 Debug.

The memory-mapped interface is optional on v7 Debug. This section describes the recommended APBv3 slave port. It provides both the memory-mapped and external debug interfaces.

A valid external debug interface for v7 Debug is any access mechanism that enables the external debugger to complete reads or writes to the memory-mapped registers described in *The memory-mapped and recommended external debug interfaces* on page C6-43.

In v7 Debug a memory-mapped interface can be implemented to provide access to the debug registers using load and store operations. Such an interface is sufficient for the requirements of the external debug interface, and therefore it is possible to implement both the memory-mapped and external debug interfaces using a single memory slave port on the processor.

This section describes the v7 Debug recommendations for an APBv3 memory slave port APBv3 as part of the external debug interface. In addition, ARM recommends a Debug Access Port capable of mastering an APBv3 bus and compatible with the *ARM Debug Interface v5 (ADIv5)*. Figure A-3 shows the recommendations.

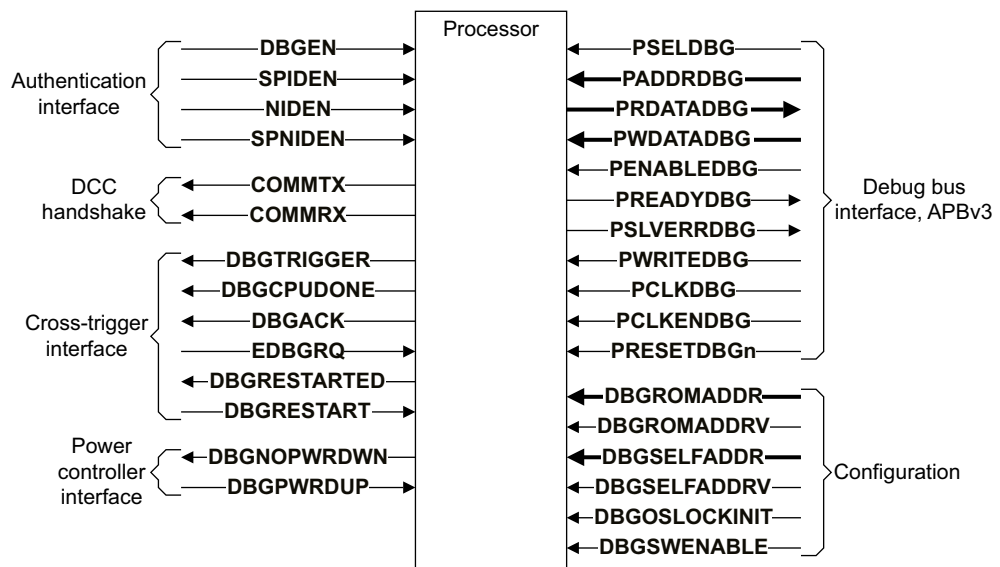

Figure A-3 Recommended external debug interface, including APBv3 slave port

In Figure A-3, signals with a lower-case n suffix are active LOW and all other signals are active HIGH.

ARM recommends that the debug registers are accessible through an ARM AMBA 3 Peripheral Bus version 1 (APBv3) external debug interface. This APBv3 interface:

- is 32 bits wide
- supports only 32-bit reads and writes

- has stallable accesses
- has slave-generated aborts
- has 10 address bits ([11:2]) mapping 4KB of memory.

An extra signal, **PADDRDBG[31]**, informs the debug slave port of the source of the access, as shown in Table A-2.

Table A-2 lists the external debug interface signals.

Table A-2 Recommended external debug interface signals

Name	Direction	Description
PSELDBG	In	Selects the external debug interface
PADDRDBG[31,11:2]	In	Address. see <i>PADDRDBG</i> on page AppxA-15
PRDATADBG[31:0]	Out	Read data
PWDATADBG[31:0]	In	Write data
PENABLEDBG	In	Indicates a second and subsequent cycle of a transfer
PREADYDBG	Out	Used to extend a transfer, by inserting wait states
PSLVERRDBG	Out	Slave-generated error response, see <i>PSLVERRDBG</i> on page AppxA-15
PWRITEDBG	In	Distinguishes between a read (LOW) and a write (HIGH)
PCLKDBG	In	Clock
PCLKENDBG	In	Clock enable for PCLKDBG

A.2.1 PADDRDBG

PADDRDBG selects the register to read or write.

In the recommended debug slave port that implements both the external debug interface and the memory-mapped interface, the complete register set is aliased twice:

- the first view, the memory-mapped interface view, starts at `0x0`
- the second view, the external debug interface view, starts at `0x80000000`.

This means that **PADDRDBG[31]** is used to distinguish the source of an access:

PADDRDBG[31] == 0 Access from system

PADDRDBG[31] == 1 Access from external debugger.

———— **Note** —————

The only bits of **PADDRDBG** that are specified are **PADDRDBG[31, 11:2]**. Bits [1:0] are not required because all registers are word-sized, and bit [31] is used as described to indicate the source of the access. Because some HDL languages do not permit partial buses to be specified in this way an actual implementation might use a different name for **PADDRDBG[31]**, such as **PADDRDBG31**.

A.2.2 PSLVERRDBG

PSLVERRDBG is used to signal an aborted access.

PSLVERRDBG has the same timing as the ready response, **PREADYDBG**. Under the v7 Debug model, accesses are only aborted, by asserting **PSLVERRDBG HIGH**, in a situation related to power-down. See also *Permission summaries for memory-mapped and external debug interfaces* on page C6-45.

Appendix B

Common VFP Subarchitecture Specification

This appendix describes version 2 of the Common VFP subarchitecture. It contains the following sections:

- *Scope of this appendix* on page AppxB-2
- *Introduction to the Common VFP subarchitecture* on page AppxB-3
- *Exception processing* on page AppxB-6
- *Support code requirements* on page AppxB-11
- *Context switching* on page AppxB-14
- *Subarchitecture additions to the VFP system registers* on page AppxB-15
- *Version 1 of the Common VFP subarchitecture* on page AppxB-23.

Note

This VFP subarchitecture specification is not part of the ARM architecture specification. Implementers and users of the ARMv7 architecture must not consider this appendix as a requirement of the architecture. It is included as an appendix to this manual only:

- as reference material for users of ARM VFP products that implement this subarchitecture
- as an example of how a VFP subarchitecture might be implemented.

The inclusion of this appendix is no indication of whether any ARMv7 VFP implementations by ARM might, or might not, implement this Common VFP subarchitecture. For details of the implemented VFP subarchitecture you must always see the appropriate product documentation.

B.1 Scope of this appendix

This specification describes the Common VFP subarchitecture. This is not part of the ARMv7 architecture specification, see the *Note* on the cover page of this appendix.

The Common VFP subarchitecture is an interface provided by VFP coprocessor hardware to support code in an operating system.

This appendix is for engineers implementing and validating a VFP coprocessor, and for engineers implementing support code in an operating system.

The main sections of this appendix describe version 3 of the Common VFP subarchitecture. Version 3 is an extension to the previously-published version 2 of the subarchitecture. Version 3 of the Common VFP subarchitecture includes more support for synchronous exception reporting.

Support code for version 1 of the subarchitecture differs from version 2 only when trapped exception handling of the Inexact exception is enabled. The differences from version 1 of the subarchitecture are described in *Version 1 of the Common VFP subarchitecture* on page AppxB-23.

The differences between versions 2 and 3 of the subarchitecture are described in *Version 2 of the Common VFP subarchitecture* on page AppxB-24.

B.2 Introduction to the Common VFP subarchitecture

The VFP architecture describes the interface provided by a VFP implementation to application software. A complete implementation of the VFP architecture might include both a hardware coprocessor and a software component, known as the support code. Support code must signal trapped floating-point exceptions to application software, and provide other implementation-dependent functions. The Common VFP subarchitecture describes an interface between VFP coprocessor hardware and support code.

B.2.1 VFP support code and bounced instructions

Support code is entered through the ARM Undefined Instruction exception vector, when the VFP hardware does not respond to a VFP instruction. This software entry is known as a *bounce*.

The bounce mechanism supports trapped floating-point exceptions. Trapped floating-point exceptions, known as *traps*, are floating-point exceptions that an implementation must pass back for application software to resolve. See *Trapped floating-point exception handling* on page AppxB-10.

Support code might perform other tasks, in addition to trap handler calls. These tasks are determined by the implementation. Typically, additional support code functions might handle rare conditions that are either difficult to implement in hardware, or gate-intensive in hardware. This approach permits software behavior to be consistent across implementations with varying degrees of hardware support.

B.2.2 Exception processing terminology

A condition that causes a VFP instruction to call support code is called an *exceptional condition*.

The VFP instruction that contains the floating-point operation requiring support code is known as the exception-generating instruction.

The VFP instruction that causes a bounce to occur is known as the trigger instruction.

An implementation can use both synchronous and asynchronous exception signaling:

- if an exception is signaled synchronously, the exception-generating instruction is also the trigger instruction.
- if an exception is signaled asynchronously, the trigger instruction is a VFP instruction that occurs after the exception-generating instruction.

An implementation can issue and complete additional VFP instructions before bouncing the trigger instruction.

An implementation can issue a maximum of one additional VFP instruction that it cannot complete. This instruction is known as the bypassed instruction. This instruction is retired in the ARM processor and cannot be reissued. Therefore, it must be executed by the VFP support code.

B.2.3 Hardware and software implementation

The Common VFP subarchitecture requires the VFP hardware implementation to perform completely all load, store and register transfer instructions. These instructions cannot generate floating-point exceptions.

The division of labor between the hardware and software components of a VFP implementation for CDP operations is IMPLEMENTATION DEFINED.

Typically, the hardware handles all common cases, to optimize performance. When the hardware encounters a case that it cannot handle on its own it calls the software component, the support code for the hardware, to deal with it.

For more information, see *Advanced SIMD and VFP extensions* on page A2-20.

B.2.4 VFP subarchitecture system registers

The Common VFP subarchitecture adds two instruction registers:

- for asynchronous exceptions, the FPINST register contains the exception-generating instruction
- the FPINST2 register contains the bypassed instruction, if there is one.

Both instruction registers are optional:

- The FPINST register is required only if at least one supported configuration can bounce instructions asynchronously.
- The FPINST2 register is required only if the processor can commit to issuing a VFP instruction before an exceptional case is detected in an earlier VFP instruction.

The Common VFP subarchitecture adds new fields to the FPEXC Register:

- the FPEXC.VECITR field contains an encoding that gives the remaining vector length of the exception-generating instruction
- the FPEXC.FP2V bit indicates if the FPINST2 register contains an instruction that the support code must execute
- the FPEXC.DEX bit is set when a synchronous bounce is caused by a floating-point exception, indicating that the support code must execute the bounced instruction
- the FPEXC.VV bit is set when a synchronous bounce is caused by a floating-point exception, and the FPEXC.VECITR field is valid
- an IMPLEMENTATION DEFINED field, for the implementation to give more information about the exceptional condition that caused the bounce.

See *The Floating-Point Exception Register (FPEXC)* on page B1-68 for a description of the minimum implementation of the FPEXC required by the VFP architecture.

———— **Note** ————

In version 2 of the Common VFP subarchitecture the FPEXC.EX bit is set to 1 only when an asynchronous bounce occurs.

Software can detect the presence of the instruction registers by testing the FPEXC.EX and FPEXC.FP2V bits, as described in *Detecting which VFP Common subarchitecture registers are implemented* on page AppxB-22.

B.3 Exception processing

The following sections describe exception processing in the Common VFP subarchitecture:

- *Asynchronous exceptions*
- *Synchronous exceptions* on page AppxB-8
- *VFP Access Permission faults* on page AppxB-10
- *Unallocated VFP instruction encodings* on page AppxB-10
- *Trapped floating-point exception handling* on page AppxB-10.

B.3.1 Asynchronous exceptions

In the Common VFP subarchitecture, an exceptional condition can be detected after executing the exceptional instruction. This means an implementation can detect an exceptional condition after an instruction has passed the point for exception handling in the ARM processor pipeline.

Handling this condition is known as asynchronous exception handling, because the exceptional condition can be detected some time after it is generated. In this case the exception handling:

- is signaled synchronously with respect to the trigger instruction
- is not signaled synchronously with respect to the instruction that generated the exceptional condition.

When an exceptional condition is detected the VFP coprocessor enters the asynchronous exceptional state, setting the FPEXC.EX bit to 1. At the application level, subsequent VFP instructions are rejected. This causes an Undefined Instruction exception, and information about the exceptional instruction is copied to:

- the FPINST register, see *The Floating-Point Instruction Registers, FPINST and FPINST2* on page AppxB-20
- the FPEXC.VECITR field.

For details of the FPEXC see:

- *The Floating-Point Exception Register (FPEXC)* on page B1-68 for the VFPv3 architectural requirements for the register
- *Additions to the Floating-Point Exception Register (FPEXC)* on page AppxB-15 for the Common VFP subarchitecture extensions to the register.

In some implementations it is possible for two VFP instructions to issue before an exceptional condition is detected in the first instruction. In this case the second instruction is copied to FPINST2, see *The Floating-Point Instruction Registers, FPINST and FPINST2* on page AppxB-20. This instruction must be executed by the support code. If there is a dependency between the instructions copied into FPINST and FPINST2 then the instruction in FPINST must be executed before the instruction in FPINST2.

The trigger instruction might not be the VFP instruction immediately following the exceptional instruction, and depending on the instruction sequence, the bounce can occur many instructions later. An implementation can continue to execute some VFP instructions before detecting the exceptional condition, provided:

- these instructions are not themselves exceptional
- these instructions are independent of the exceptional instruction
- the operands for the exceptional instruction are still available after the execution of the instructions.

Determination of the trigger instruction

VMSR and VMRS instructions that access the FPEXC, FPSID, FPINST or FPINST2 registers do not trigger exception processing.

These system registers are not used in normal VFP application code, but are designed for use by support code and the operating system. Accesses to these registers do not bounce when the processor is in an asynchronous exceptional state, indicated by FPEXC.EX == 1. This means the support code can read information out of these registers, before clearing the exceptional condition by setting FPEXC.EX to 0.

All other VFP instructions, including VMSR and VMRS instructions that access the FPSCR, trigger exception processing if there is an outstanding exceptional condition. For more information, see *VFP support code* on page B1-70.

Exception processing for scalar instructions

When an exceptional condition is detected in a scalar CDP instruction:

- the exception-generating instruction is copied to the FPINST Register, see *The Floating-Point Instruction Registers, FPINST and FPINST2* on page AppxB-20
- the FPEXC.VECITR field is set to 0b111 to indicate that no short vector iterations are required
- the FPEXC.EX bit is set to 1
- all the operand registers to the instruction are restored to their original values, so that the instruction can be re-executed in support code
- If the execution of the instruction would set the cumulative exception flags for any exception, hardware might or might not set these flags.

————— Note —————

Because the cumulative exception flags are cumulative, it is always acceptable for the support code to set the exception flags to 1 as a result of emulating the instruction, even if the hardware has set them.

If there is a bypassed instruction then this is copied to the FPINST2 Register, and the FPEXC.FP2V bit is set to 1.

The next VFP instruction issued becomes the trigger instruction and causes entry to the operating system.

Exception processing for short vector instructions

With a short vector instruction, any iteration might be exceptional. When an exceptional condition is detected for a vector iteration, previous iterations can complete. For the exceptional iteration:

- The exception-generating instruction is copied to the FPINST register, see *The Floating-Point Instruction Registers, FPINST and FPINST2* on page AppxB-20. The source and destination registers are modified to point to the exceptional iteration.
- The FPEXC.VECITR field is written with the number of iterations remaining after the exceptional iteration.
- The FPEXC.EX bit is set to 1.
- The input operand registers to that iteration, and subsequent iterations, are restored to their original values.
- If the execution of the exception iteration, or subsequent iterations, would set the cumulative exception flags for any exception, hardware might or might not set these flags.

———— **Note** —————

Because the cumulative exception flags are cumulative, it is always acceptable for the support code to set the exception flags to 1 as a result of emulating the iterations of the instruction, even if the hardware has set them.

If there is a bypassed instruction then this is copied to the FPINST2 Register, and the FPEXC.FP2V bit is set to 1.

The next VFP instruction issued becomes the trigger instruction and causes entry to the operating system.

B.3.2 Synchronous exceptions

In the Common VFP subarchitecture, an implementation can signal a floating-point exception synchronously.

When an exceptional condition is detected in a CDP instruction, and the implementation chooses to signal the condition synchronously:

- if the exceptional condition is a trapped floating-point exception the FPEXC.DEX bit is set to 1
- if the reason for the exceptional condition is IMPLEMENTATION DEFINED then the value of the FPEXC.DEX bit is IMPLEMENTATION DEFINED
- the instruction is bounced, causing an Undefined Instruction exception
- FPEXC.EX is not set to 1.

The FPINST and FPINST2 registers are not used in this case.

For scalar CDP instructions:

- All the operand registers to the instruction are restored to their original values, so that the instruction can be re-executed in support code.
- It is IMPLEMENTATION DEFINED whether the FPEXC.VV bit is set to 1. If it is, the FPEXC.VECITR field will contain 0b111.
- If the execution of the instruction would set the cumulative exception flags for any exception, hardware might or might not set these flags.

———— **Note** —————

Because the cumulative exception flags are cumulative, it is always acceptable for the support code to set the exception flags to 1 as a result of emulating the instruction, even if the hardware has set them.

For short vector instructions, any iteration might be exceptional. When an exceptional condition is detected for a vector iteration, previous iterations can complete. For the exceptional iteration:

- The FPEXC.VECITR field is written with a value that encodes the number of iterations remaining after the exceptional iteration. For details of the encoding see *Subarchitecture additions to the VFP system registers* on page AppxB-15.
- The FPEXC.VV bit is set to 1.
- The input operand registers to that iteration, and subsequent iterations, are restored to their original values.
- If the execution of the exception iteration, or subsequent iterations, would set the cumulative exception flags for any exception, hardware might or might not set these flags.

———— **Note** —————

Because the cumulative exception flags are cumulative, it is always acceptable for the support code to set the exception flags to 1 as a result of emulating the iterations of the instruction, even if the hardware has set them.

———— **Note** —————

- In version 1 of the Common VFP subarchitecture, all exceptions are signaled synchronously when the FPSCR.IXE bit is set to 1, see *Floating-point Status and Control Register (FPSCR)* on page A2-28. The FPEXC.DEX bit is RAZ/WI. For more information, see *Subarchitecture v1 exception handling when FPSCR.IXE == 1* on page AppxB-23.
- In version 2 of the Common VFP subarchitecture, exceptional conditions that cause synchronous exceptions are signaled by setting FPEXC.DEX to 1. For more information, see *Version 2 of the Common VFP subarchitecture* on page AppxB-24.

B.3.3 VFP Access Permission faults

When the VFP register bank is disabled by disabling coprocessors 10 and 11 in a coprocessor access control register, any attempt to use a VFP instruction will bounce. When the VFP register bank is disabled by clearing the FPEXC.EN bit to 0, any attempt to access a VFP registers, except the FPEXC or FPINST register, will bounce.

In a system where the VFP can be disabled, handler code must check that the VFP is enabled before processing a VFP exception.

B.3.4 Unallocated VFP instruction encodings

Unallocated VFP instruction encodings are those coprocessor 10 and 11 instruction encodings that are not allocated for VFP instructions by ARM.

An unallocated VFP instruction encoding bounces synchronously to the VFP Undefined Instruction handler code. In this case the VFP state is not modified, the FPEXC.EX bit is set to 0, and the FPEXC.DEX bit is set to 0. Unallocated instruction exception handling is synchronous.

The VFP exception handler code can check the FPEXC.EX bit, to find out if the VFP is using asynchronous exception handling to handle a previous exceptional condition.

If FPEXC.EX=1, the support code is called to process a previous exceptional instruction. On return from the support code the trigger instruction is reissued, and if the trigger instruction is an unallocated instruction the Undefined Instruction handler is re-entered, with FPEXC.EX=0.

If FPEXC.EN == 1, FPEXC.EX == 0 and FPEXC.DEX == 0, the handler code might have been called as a result of an unallocated instruction encoding or as a result of an allocated instruction encoding which has not been implemented:

- If the instruction is not a CDP instruction, the instruction is an unallocated instruction encoding and execution can jump to the unallocated instructions handler provided by the system.
- If the instruction is a CDP instruction, the support code must identify whether the instruction is one that it can handle. If it is not, then execution can jump to the unallocated instructions handler provided by the system.

B.3.5 Trapped floating-point exception handling

Trapped floating-point exceptions are never handled by hardware. When a trapped exception is detected by hardware the exception-generating instruction must be re-executed by the support code. The support code must re-detect and signal the exception.

B.4 Support code requirements

When an instruction is bounced, control passes to the Undefined Instruction exception handler provided by the operating system.

The operating system is expected to:

1. Perform a standard exception entry sequence, preserving process state and re-enabling interrupts.
2. Decode the bounced instruction sufficiently to determine whether it is a coprocessor instruction, and if so, for which coprocessor.
3. Check whether the bounced instruction is conditional, and if it is conditional, check whether the condition was passed. This ensures correct execution on implementations that perform the bounce even for an instructions that would fail its condition code check.
4. Check whether the coprocessor is enabled in the access control register, and take appropriate action if not. For example, in the lazy context switch case described in *Context switching with the Advanced SIMD and VFP extensions* on page B1-69, the operating system context switches the VFP state.
5. Call an appropriate second-level handler for the coprocessor, passing in:
 - the instruction that bounced
 - the state of the associated process.
6. The second-level handler must indicate whether the bounced instruction is to be retried or skipped. It can also signal an additional exception that must be passed on to the application.
7. Restore the original process, transferring control to an exception handler in the application context if necessary.

If the bounced instruction is a VFP instruction, control is passed to a second-level handler for VFP coprocessor instructions. For the Common VFP subarchitecture this:

1. Uses the FPEXC.EX and FPEXC.DEX bits to determine the bounced instruction and associated handling. The three possible cases are:

FPEXC.EX == 0, FPEXC.DEX == 0

The bounce was synchronous. The exception-generating instruction is the instruction that bounced:

- If the exception-generating instruction is not a CDP instruction, or the version of the subarchitecture is before version 3, the bounce was caused by an unallocated instruction encoding or a VFP access permission fault. Branch to operating system specific code that takes appropriate action.
- If the exception-generating instruction is a CDP instruction, check whether the bounce was caused by a VFP access permission fault:
 - If it is a VFP access permission fault, branch to operating system specific code that takes appropriate action.

- If it is not a VFP access permission fault, determine the iteration count from FPSCR.LEN, and set the return address to the instruction following the bounced instruction. Then continue processing from step 2.

FPEXC.EX == 0, FPEXC.DEX == 1

The bounced instruction was executed as a valid floating-point operation, and it bounced because of an exceptional condition.

The exception-generating instruction is the instruction that bounced.

The iteration count is determined from either FPSCR.LEN or FPEXC.VECITR, depending on the value of FPEXC.VV:

- if FPEXC.VV is set to 0, the iteration count is determined from FPSCR.LEN
- if FPEXC.VV is set to 1, the iteration count is determined from FPEXC.VECITR.

Clear the FPEXC.DEX bit to 0, and set the return address to the instruction following the bounced instruction.

Continue processing from step 2.

FPEXC.EX == 1

The VFP bounce resulted from an asynchronous exception.

Collect information about the exceptional instruction, and any other instructions that are to be executed by support code. Clear the exceptional condition. For each instruction the data collected include the instruction encoding and the number of vector iterations.

This involves:

- Read the FPINST Register to find the exception-generating instruction.
Read the FPEXC.VECITR field to find the remaining iteration count for this instruction.
- Check FPEXC.FP2V. If it is set to 1 there is a bypassed instruction:
 - Read the FPINST2 Register to find the bypassed instruction
 - Clear the FPEXC.EX and FPEXC.FP2V bits to 0.
 - Read the FPSCR.LEN field to find the iteration count for the bypassed instruction.

The FPSCR can be read-only when FPEXC.EX == 0.

Otherwise there is no bypassed instruction:

- Clear FPEXC.EX to 0.

FPEXC.EX == 0 indicates there is no subarchitecture state to context switch.

Set the return address to re-execute the trigger instruction.

Note

In version 1 of the Common VFP subarchitecture, the meaning of the FPExc.EX bit changes when the FPSCR.IXe bit is set to 1. The FPSCR.IXe bit can be checked only after the FPExc.EX bit is cleared to 0. If FPSCR.IXe is 0, go to step 2 below. If FPSCR.IXe is set to 1:

- the information collected from the VFP registers and the calculated return address are ignored
 - the exception-generating instruction is the instruction that bounced, and the iteration count is the FPSCR.LEN value, as for the FPExc.DEX == 1 case.
 - set the return address to the instruction following the bounced instruction.
-

2. Packages up the information about the VFP instruction and iteration count into pairs in a form suitable to pass to the Computation Engine, described in step 3.

At this point the packaged information can be sent as a signal to another exception handler in the application, where the support code continues. Continuing in the application context makes it possible for the support code to call trap handlers directly, in the application.

3. Executes in software the instruction iterations described in step 2. All configuration information except vector length is read from the FPSCR.

In previous support code implementations by ARM, this execution is performed by the VFP *Computation Engine* function.

If trapped floating-point exceptions are enabled, the Computation Engine calls trap handlers as required.

If the exceptional condition is an unallocated instruction, the Computation Engine will call a suitable error routine.

4. Returns to the appropriate return address.

B.5 Context switching

Context switch code must check the FPEXC.EX bit when saving or restoring VFP state.

If the FPEXC.EX bit is set to 1 then additional subarchitecture information must be saved. Any attempt to access other registers while the FPEXC.EX bit is set to 1 might bounce.

For the Common VFP subarchitecture, if the FPEXC.EX bit is set to 1:

- the FPINST register contains a bounced instruction and must be saved
- if the FPEXC.FP2V bit is set, the FPINST2 register must be saved.

The FPEXC register must always be saved.

When the subarchitecture specific information has been saved, context switch code must clear the FPEXC.EX bit to 0 before saving other registers.

When restoring state, check the saved values of the FPEXC.EX bit and FPEXC.FP2V bit to determine whether the extra registers must be restored.

———— **Note** —————

Context switch code can be written to always save and restore the subarchitecture registers. In this case appropriate context switch code must be chosen based on the registers implemented, using the detection mechanism described in *Detecting which VFP Common subarchitecture registers are implemented* on page AppxB-22.

B.6 Subarchitecture additions to the VFP system registers

The Common VFP subarchitecture requires additions to the VFP system register implementation:

- extra fields are defined in the FPEXC, see *Additions to the Floating-Point Exception Register (FPEXC)*
- additional VFP registers might be defined, see *The Floating-Point Instruction Registers, FPINST and FPINST2* on page AppxB-20.

Also, the Subarchitecture field of the FPSID must identify the Common VFP subarchitecture version, see *Floating-point System ID Register (FPSID)* on page B5-34.

For more information about the VFP register implementation for the Common VFP subarchitecture see:

- *Detecting which VFP Common subarchitecture registers are implemented* on page AppxB-22
- *Accessing the VFP Common subarchitecture registers* on page AppxB-22.

B.6.1 Additions to the Floating-Point Exception Register (FPEXC)

See *The Floating-Point Exception Register (FPEXC)* on page B1-68 for the architectural definition of the FPEXC, including its purpose and accessibility.

The format of the FPEXC when version 3 of the Common VFP subarchitecture is implemented is:

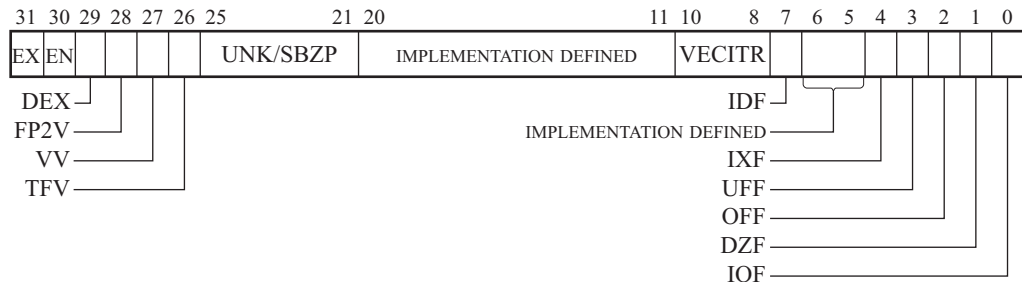

EX, bit [31] See *The Floating-Point Exception Register (FPEXC)* on page B1-68 for the definition of this bit.

On an implementation that does not require asynchronous exception handling this bit is RAZ/WI. In this case the FPINST and FPINST2 registers are not implemented.

For details of how, in Common VFP subarchitecture v1, the meaning of the EX bit changes when the FPSR.IEX bit is set to 1, see *Subarchitecture v1 exception handling when FPSCR.IXE == 1* on page AppxB-23.

EN, bit [30] See *The Floating-Point Exception Register (FPEXC)* on page B1-68 for the definition of this bit.

DEX, bit [29] Defined synchronous instruction exceptional flag. This field is valid only if FPEXC.EX == 0.

When a VFP exception has occurred, the meaning of this bit is:

- 0** ~~A synchronous exception has occurred when processing an instruction in CP10 or CP11. This is either:~~
- ~~• an allocated floating-point instruction that is not implemented in hardware~~
 - ~~• an unallocated instruction in CP10 or CP11.~~
- 1** ~~A synchronous exception has occurred on an allocated floating-point instruction. This is either:~~
- ~~• an allocated floating-point instruction that is not implemented in hardware~~
 - ~~• an allocated floating-point instruction that has encountered an exceptional condition.~~

DEX must be cleared to 0 by the exception handling routine.

On an implementation that does not require synchronous exception handling this bit is RAZ/WI.

FP2V, bit [28] FPINST2 instruction valid flag. This field is valid only if FPEXC.EX == 1.

When an asynchronous VFP exception has occurred, the meaning of this bit is:

- 0** The FPINST2 Register does not contain a valid instruction.
- 1** The FPINST2 Register contains a valid instruction.

FP2V must be cleared to 0 by the exception handling routine.

If the FPINST2 Register is not implemented this bit is RAZ/WI.

VV, bit [27] VECITR valid flag. This field is valid only if FPEXC.DEX == 1.

When a synchronous VFP exception has occurred, the meaning of this bit is:

- 0** FPEXC.VECITR field is not valid, and the number of remaining vector steps can be determined from FPSCR.LEN.
- 1** FPEXC.VECITR field is valid, and the number of remaining vector steps can be determined from FPEXC.VECITR.

VV must be cleared to 0 by the exception handling routine.

If the VV field is not implemented this bit is RAZ/WI.



TFV, bit [26] Trapped Fault Valid flag. Indicates whether FPEXC bits [7,4:0] act as flags to indicate trapped exceptions or have an IMPLEMENTATION DEFINED meaning:

- 0** FPEXC bits[7,4:0] have an IMPLEMENTATION DEFINED meaning
- 1** FPEXC bits[7,4:0] indicate the presence of trapped exceptions that have occurred at the time of the exception. All trapped exceptions that occurred at the time of the exception have their flags set.

This bit has a fixed value and ignores writes.

Bits [25:21] Reserved. UNK/SBZP.

Bits [20:11, 6:5]

IMPLEMENTATION DEFINED.

These bits are IMPLEMENTATION DEFINED. They can contain IMPLEMENTATION DEFINED information about the cause of an exception. They might be used by the implementation to indicate why an instruction was bounced to support code.

These bits must be cleared to zero by the exception handling routine.

VECITR, bits [10:8]

Vector iteration count for the VFP instruction with the exceptional condition. This field is valid only if either:

- FPEXC.EX == 1
- FPEXC.DEX == 1 and FPEXC.VV == 1.

This field contains the number of short vector iterations remaining after the iteration in which a potential exception was detected. Possible values are:

- 0b000** 1 iteration
- 0b001** 2 iterations
- 0b010** 3 iterations
- 0b011** 4 iterations
- 0b100** 5 iterations
- 0b101** 6 iterations
- 0b110** 7 iterations
- 0b111** 0 iterations.

The count held in this field does not include the iteration in which the exception occurred. This field reads as 0b111 if:

- the final iteration of an instruction is bounced to the support code
- the instruction is a scalar operation.

VECITR must be cleared to 0b000 by the exception handling routine.

IDF, bit [7] Input Denormal trapped exception flag, or IMPLEMENTATION DEFINED. The meaning of this bit depends on the value of FPEXC.TFV:

FPEXC.TFV == 0

This bit is IMPLEMENTATION DEFINED. It can contain IMPLEMENTATION DEFINED information about the cause of an exception. It might be used by the implementation to indicate why an instruction was bounced to support code.

FPEXC.TFV == 1

This bit is the Input Denormal trapped exception flag. It indicates whether an Input Denormal exception occurred while FPSCR.IDE was 1.

In this case, the meaning of this bit is:

0 Input denormal exception has not occurred.

1 Input denormal exception has occurred.

Input Denormal exceptions can occur only when FPSCR.FZ is 1.

In both cases this bit must be cleared to 0 by the exception handling routine.

IXF, bit [4] Inexact trapped exception flag, or IMPLEMENTATION DEFINED. The meaning of this bit depends on the value of FPEXC.TFV:

FPEXC.TFV == 0

This bit is IMPLEMENTATION DEFINED. It can contain IMPLEMENTATION DEFINED information about the cause of an exception. It might be used by the implementation to indicate why an instruction was bounced to support code.

FPEXC.TFV == 1

This bit is the Inexact trapped exception flag. It indicates whether an Inexact exception occurred while FPSCR.IXE was 1.

In this case, the meaning of this bit is:

0 Inexact exception has not occurred.

1 Inexact exception has occurred.

In both cases this bit must be cleared to 0 by the exception handling routine.

UFF, bit [3] Underflow trapped exception flag, or IMPLEMENTATION DEFINED. The meaning of this bit depends on the value of FPEXC.TFV:

FPEXC.TFV == 0

This bit is IMPLEMENTATION DEFINED. It can contain IMPLEMENTATION DEFINED information about the cause of an exception. It might be used by the implementation to indicate why an instruction was bounced to support code.

FPEXC.TFV == 1

This bit is the Underflow trapped exception flag. It indicates whether an Underflow exception occurred while FPSCR.UFE was 1.

In this case, the meaning of this bit is:

0 Underflow exception has not occurred.

1 Underflow exception has occurred.

Note

An Underflow trapped exception can occur only when FPSCR.FZ is 0, because when FPSCR.FZ is 1, FPSCR.UFE is ignored and treated as 0.

In both cases this bit must be cleared to 0 by the exception handling routine.

OFF, bit [2] Overflow trapped exception flag, or IMPLEMENTATION DEFINED. The meaning of this bit depends on the value of FPEXC.TFV:

FPEXC.TFV == 0

This bit is IMPLEMENTATION DEFINED. It can contain IMPLEMENTATION DEFINED information about the cause of an exception. It might be used by the implementation to indicate why an instruction was bounced to support code.

FPEXC.TFV == 1

This bit is the Overflow trapped exception flag. It indicates whether an Overflow exception occurred while FPSCR.OFE was 1.

In this case, the meaning of this bit is:

- 0** Overflow exception has not occurred.
- 1** Overflow exception has occurred.

In both cases this bit must be cleared to 0 by the exception handling routine.

DZE, bit [1] Divide-by-zero trapped exception flag, or IMPLEMENTATION DEFINED. The meaning of this bit depends on the value of FPEXC.TFV:

FPEXC.TFV == 0

This bit is IMPLEMENTATION DEFINED. It can contain IMPLEMENTATION DEFINED information about the cause of an exception. It might be used by the implementation to indicate why an instruction was bounced to support code.

FPEXC.TFV == 1

This bit is the Divide-by-zero trapped exception flag. It indicates whether a Divide-by-zero exception occurred while FPSCR.DZE was 1.

In this case, the meaning of this bit is:

- 0** Divide-by-zero exception has not occurred.
- 1** Divide-by-zero exception has occurred.

In both cases this bit must be cleared to 0 by the exception handling routine.

IOF, bit [0] Invalid Operation trapped exception flag, or IMPLEMENTATION DEFINED. The meaning of this bit depends on the value of FPEXC.TFV:

FPEXC.TFV == 0

This bit is IMPLEMENTATION DEFINED. It can contain IMPLEMENTATION DEFINED information about the cause of an exception. It might be used by the implementation to indicate why an instruction was bounced to support code.

FPEXC.TFV == 1

This bit is the Invalid Operation trapped exception flag. It indicates whether an Invalid Operation exception occurred while FPSCR.IOE was 1.

In this case, the meaning of this bit is:

- 0** Invalid Operation exception has not occurred.
- 1** Invalid Operation exception has occurred.

In both cases this bit must be cleared to 0 by the exception handling routine.

B.6.2 The Floating-Point Instruction Registers, FPINST and FPINST2

The Floating-Point Instruction Registers hold floating-point instructions relating to floating-point exception handling in a system that implements the Common VFP subarchitecture:

- FPINST contains the exception-generating instruction
- FPINST2 contains the bypassed instruction.

FPINST and FPINST2 are:

- In the CP10 and CP11 register space.
- Present only when the Common VFP subarchitecture is implemented. A Common VFP subarchitecture implementation can support:
 - both FPINST and FPINST2
 - FPINST but not FPINST2
 - neither of the Floating-Point Instruction Registers.
- 32-bit read/write registers.
- If the Security Extensions are implemented, Configurable access registers. FPINST and FPINST2 are only accessible in the Non-secure state if the CP10 and CP11 bits in the NSACR are set to 1, see *c1, Non-Secure Access Control Register (NSACR)* on page B3-110.
- Accessible only in privileged modes, and only if both:
 - access to coprocessors CP10 and CP11 is enabled in the Coprocessor Access Control Register, see *c1, Coprocessor Access Control Register (CPACR)* on page B3-104 (VMSA implementation), or *c1, Coprocessor Access Control Register (CPACR)* on page B4-51 (PMSA implementation)
 - the VFP coprocessor is enabled by setting the FPEXC.EN bit to 1.

The format of an instruction in FPINST or FPINST2 is:

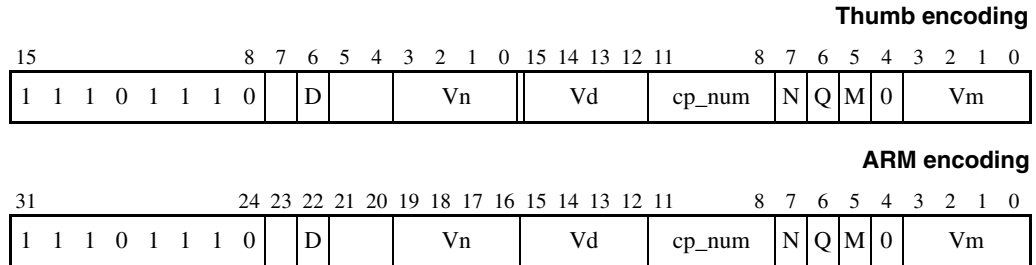

The format is the same as the format of the issued instruction, with a number of modifications. For more information, see *VFP data-processing instructions* on page A7-24. The modifications from the issued instruction are:

- In the Thumb encoding, bits [15:8] of the first halfword and bit [4] of the second halfword are reserved. In the ARM encoding, bits [31:24, 4] are reserved:
 - software must ignore these bits when reading this register, and must not modify these bits when writing to this register
 - hardware must set these bits to the values shown in the encoding diagrams, that map to the encoding of an ARM CDP instruction with the AL (always) condition.
- If the instruction is a short vector instruction:
 - for the FPINST Register, the source and destination registers that reference vectors are updated to point to the source and destination registers of the exceptional iteration. The FPEXC.VECITR field contains the number of iterations remaining. For more information, see *Exception processing for short vector instructions* on page AppxB-8.
 - for the FPINST Register, the full vector must be processed by support code, using the current vector length from the FPSCR. Source and destination registers that reference vectors are unchanged from the issued instruction.

Both MRS register read and MSR register write instructions are provided for the FPINST and FPINST2 registers, see *Accessing the VFP Common subarchitecture registers* on page AppxB-22.

When an exceptional instruction is bounced to support code and placed in the FPINST Register, the FPEXC.EX bit is set to 1. This indicates that valid information is available in the FPINST Register. In addition, when a second issued instruction is copied to the FPINST2 Register, the FPEXC.FP2V bit is set to 1. This indicates that valid information is available in the FPINST2 Register.

When the FPEXC.EX bit is 0, indicating the VFP is not in an asynchronous exceptional state, reads of the FPINST and FPINST2 Registers are UNPREDICTABLE and the values returned might change.

When the FPEXC.FP2V bit is 0, indicating that no second instruction was issued, reads of the FPINST2 Register are UNPREDICTABLE and the value returned might change.

Any value read from a Floating-Point Instruction Register can be written back to the same register. This means context switch and debugger software can save and restore Floating-Point Instruction Register values. Writing a value that has not been read from the same register writes an UNKNOWN value to the Floating-Point Instruction Register. For example, attempting to write an instruction with coprocessor number 0 writes an UNKNOWN value to the Floating-Point Instruction Register.

B.6.3 Accessing the VFP Common subarchitecture registers

Use the VMRS and VMSR instructions to access the registers for the VFP Common subarchitecture implementation, see:

- VMRS on page B6-27
- VMSR on page B6-29.

The additional registers in the VFP Common subarchitecture are accessed using:

- reg = 0b1001 for FPINST
- reg = 0b1010 for FPINST2

If FPINST or FPINST2 is not defined, the corresponding VMRS and VMSR instructions are UNPREDICTABLE.

The VMRS and VMSR instructions with reg = 0b1011 and reg = 0b11xx are UNPREDICTABLE.

B.6.4 Detecting which VFP Common subarchitecture registers are implemented

An implementation can choose not to implement FPINST and FPINST2, if these registers are not required.

System software can detect which registers are present as follows:

```
Set FPEXC.EX=1 and FPEXC.FP2V=1
Read back the FPEXC register
if FPEXC.EX == 0 then
    Neither FPINST nor FPINST2 are implemented
else
    if FPEXC.FP2V == 0 then
        FPINST is implemented, FPINST2 is not implemented.
    else
        Both FPINST and FPINST2 are implemented.
Clean up
```

B.7 Version 1 of the Common VFP subarchitecture

Version 1 of the Common VFP subarchitecture has special behavior when the FPSCR.IXE bit is set to 1. The Common VFP subarchitecture version can be identified by checking FPSID bits [22:16]. This field is 0b0000001 for version 1. In version 1 of the Common VFP subarchitecture the FPEXC.DEX bit is RAZ/WI.

B.7.1 Subarchitecture v1 exception handling when FPSCR.IXE == 1

In version 1 of the Common VFP subarchitecture, the mechanism for bouncing instructions changes when the FPSCR.IXE bit, the Inexact exception enable bit, is set to 1.

When FPSCR.IXE is set to 1, the FPEXC.EX bit signals a synchronous exception, in the same way as the FPEXC.DEX bit. In this case:

- the exceptional instruction is the instruction that caused the Undefined Instruction exception
- the FPINST Register and the FPEXC.VECITR field are not valid.

When FPSCR.IXE is 0 the FPEXC.EX bit signals an asynchronous exception, as for later versions of the subarchitecture.

B.8 Version 2 of the Common VFP subarchitecture

Version 2 of the Common VFP subarchitecture can be identified by checking FPSID bits [22:16]. This field is 0b0000010 for version 2.

Version 2 of the Common VFP subarchitecture has three differences from version 3 of the subarchitecture. Before version 3 of the Common VFP subarchitecture:

- The FPEXC.EX == 0, FPEXC.DEX == 0 encoding is used only for unallocated instructions or permission faults. As a result, the determination that an instruction should be passed to the Computation Engine is simpler than it is for version 3 of the Common VFP subarchitecture.
- Bounces are not handled synchronously on short vector instructions unless all iterations of the vector are to be handled in software. This means that the FPEXC.VV bit is always 0 before version 3.
- The FPEXC.TFV bit is set to 0, so the additional information bits [7, 4:0] of FPEXC is IMPLEMENTATION DEFINED.

Appendix C

Legacy Instruction Mnemonics

This appendix provides information about the Unified Assembler Language equivalents of older assembler language instruction mnemonics.

It contains the following sections:

- *Thumb instruction mnemonics* on page AppxC-2
- *Pre-UAL pseudo-instruction NOP* on page AppxC-3.

C.1 Thumb instruction mnemonics

Table C-1 lists the UAL equivalents of the mnemonics used in pre-UAL Thumb assembly language. Except where noted, the Thumb mnemonics conflict with UAL and cannot be supported by assemblers as synonyms. Thumb code cannot be correctly assembled by a UAL assembler unless these changes are made.

All other Thumb instructions are the same in UAL as in Thumb assembler language, or can be supported as synonyms.

Table C-1 Thumb instruction mnemonics

Former Thumb assembler mnemonic	UAL equivalent
ADC	ADCS
ADD	ADDS ^a
AND	ANDS
ASR	ASRS
BIC	BICS
EOR	EORS
LSL	LSLS
MOV <Rd>, #<imm>	MOVS <Rd>, #<imm>
MOV <Rd>, <Rn>	ADDS <Rd>, <Rn>, #0 ^b
MUL	MULS
MVN	MVNS
ORR	ORRS
ROR	RORS
SBC	SBCS
SUB	SUBS ^c

- a. If either or both of the operands is R8-R15, ADD not ADDS.
- b. If either or both of the operands is R8-R15, MOV <Rd>, <Rn> not ADDS <Rd>, <Rn>, #0.
- c. If the operand register is SP, SUB not SUBS.

C.2 Pre-UAL pseudo-instruction NOP

In pre-UAL assembler code, NOP is a pseudo-instruction, equivalent to:

- MOV R0,R0 in ARM code
- MOV R8,R8 in Thumb code.

Assembling the NOP mnemonic as UAL will not change the functionality of the code, but will change:

- the instruction encoding selected
- the architecture variants on which the resulting binary will execute successfully, because the NOP instruction was introduced in ARMv6K and ARMv6T2.

To avoid these changes, replace NOP in the assembler source code with the appropriate one of MOV R0,R0 and MOV R8,R8, before assembling as UAL.

Appendix D

Deprecated and Obsolete Features

This appendix contains the following sections:

- *Deprecated features* on page AppxD-2
- *Deprecated terminology* on page AppxD-5
- *Obsolete features* on page AppxD-6
- *Semaphore instructions* on page AppxD-7
- *Use of the SP as a general-purpose register* on page AppxD-8
- *Explicit use of the PC in ARM instructions* on page AppxD-9
- *Deprecated Thumb instructions* on page AppxD-10.

D.1 Deprecated features

The features described in this section are present in ARMv7 for backwards compatibility. You must avoid using them in new applications where possible. They might not be present in future versions of the ARM architecture.

See also *Semaphore instructions* on page AppxD-7, *Use of the SP as a general-purpose register* on page AppxD-8, and *Explicit use of the PC in ARM instructions* on page AppxD-9.

D.1.1 VFP vector mode

The use of VFP vector mode is deprecated in ARMv7. For details see Appendix F *VFP Vector Operation Support*.

D.1.2 VFP FLDMX and FSTMX instructions

The use of VLDM.64 and VSTM.64 instruction encodings with an odd immediate offset is deprecated from ARMv6. The use of their pre-UAL mnemonics FLDMX and FSTMX is deprecated, except for disassembly purposes. For details see *FLDMX, FSTMX* on page A8-101.

D.1.3 Fast context switch extension

Use of the *Fast Context Switch Extension* (FCSE) is deprecated from ARMv6, and in ARMv7 implementation of the FCSE is optional. For details of the FCSE see Appendix E *Fast Context Switch Extension (FCSE)*.

D.1.4 Direct manipulation of the Endianness bit

The use of the MSR instruction to write the Endianness bit in User mode is deprecated. Use the SETEND instruction.

D.1.5 Strongly-ordered memory accesses and interrupt masks

Any ARMv5 instruction that implicitly or explicitly changes the interrupt masks in the CPSR, and appears in program order after a Strongly-ordered access, waits for the Strongly-ordered memory access to complete. Dependence on this behavior is deprecated in ARMv6 and ARMv7, and code must not rely on this behavior. Use an explicit memory barrier instead. For details see *Strongly-ordered memory* on page A3-34.

D.1.6 Unaligned exception returns

ARM deprecates any dependence on the requirements that the hardware ignores bits of the address transferred to the PC on an exception return. See *Alignment of exception returns* on page B1-39.

D.1.7 Use of AP[2] = 1, AP[1:0] = 0b10 in MMU access permissions

This encoding means read-only for both privileged mode and User mode accesses, but its use is deprecated in VMSAv7. Use AP[2] = 1, AP[1:0] = 0b11. For details see *Memory access control* on page B3-28.

D.1.8 The Domain field in the DFSR

Use of the Domain field in the DFSR is deprecated. For details see *c6, Data Fault Address Register (DFAR)* on page B3-124.

D.1.9 Watchpoint Fault Address Register in CP15

Use of the CP15 alias of the *Watchpoint Fault Address Register (DBGWFAR)* is deprecated. Use the CP14 DBGWFAR instead. For details see *Extended CP14 interface* on page C6-33.

D.1.10 CP15 memory barrier operations

Use of the CP15 c7 memory barrier operations is deprecated. The ARM and Thumb instruction sets include instructions that perform these operations. Table D-1 shows the deprecated CP15 encodings and the replacement ARMv7 instructions.

Table D-1 Deprecated CP15 c7 memory barrier operations

Deprecated CP15 encoding				Operation	Instruction description
CRn	opc1	CRm	opc2		
c7	0	c5	4	Instruction Synchronization Barrier	See <i>ISB</i> on page A8-102
c7	0	c10	4	Data Synchronization Barrier	See <i>DSB</i> on page A8-92
c7	0	c10	5	Data Memory Barrier	See <i>DMB</i> on page A8-90

D.1.11 Use of Hivecs exception base address in PMSA implementations

Use of the high vector exception base address (Hivecs) of 0xFFFF0000 is deprecated in PMSA implementations. ARM recommends that Hivecs is used only in VMSA implementations. For more information, see *Exception vectors and the exception base address* on page B1-30.

D.1.12 Use of Secure User halting debug

From v7 Debug, the use of Secure User halting debug is deprecated. For more information, see *About invasive debug authentication* on page C2-2.

D.1.13 Escalation of privilege on CP14 and CP15 accesses in Debug state

Except for the Baseline CP14 debug registers, ARM deprecates accessing any CP14 or CP15 register from User mode in Debug state if that register cannot be accessed from User mode in Non-debug state. For more information, see *Coprocessor and Advanced SIMD instructions in Debug state* on page C5-16.

D.1.14 Interrupts or asynchronous aborts in a sequence of memory transactions

ARM deprecates any reliance by software on the behavior that an interrupt or asynchronous abort cannot occur in a sequence of single-copy atomic memory transactions generated by a single load/store instruction to Normal memory. For more information, see *Low interrupt latency configuration* on page B1-43.

D.1.15 Reading the Debug Program Counter Sampling Registers as register 33

ARM deprecates reading the DBGPCSR as debug register 33 when it is also implemented as debug register 40. For more information see *Program Counter sampling* on page C8-2.

D.1.16 Old mnemonics for CP15 c8 operations to invalidate entries in a unified TLB

The ARMv7-A base architecture defines three CP15 c8 operations to invalidate entries in a unified TLB. The original mnemonics for these are changed, each dropping the initial U. The original mnemonics remain synonyms for the operations, but ARM deprecates using the old mnemonics. Table D-2 shows the changed mnemonics and the encodings of the operations.

Table D-2 Changed mnemonics for CP15 c8 unified TLB operations

Encoding				Mnemonic	
CRn	opc1	CRm	opc2	New	Deprecated
c8	0	c7	0	TLBIALL	UTLBIALL
			1	TLBIMVA	UTLBIMVA
			2	TLBIMVA	UTLBIMVA

For more information about these operations see *CP15 c8, TLB maintenance operations* on page B3-138.

D.2 Deprecated terminology

Table D-3 shows terms that were used in earlier editions of the *ARM Architecture Reference Manual*, and the supplements to it, that are no longer used. The replacement terms are not in general exact synonyms, but might reflect altered behavior more accurately.

Table D-3 Deprecated terminology

Old terminology	Replaced by
Drain Write Buffer, Data Write Barrier (DWB)	Data Synchronization Barrier
Prefetch Flush (PFF)	Instruction Synchronization Barrier

D.3 Obsolete features

The features described in the following sections were deprecated in ARMv6, and are no longer supported in ARMv7.



D.3.1 Rotated aligned accesses

Unaligned accesses, where permitted, were treated as rotated aligned accesses before ARMv6. This behavior was configurable, but deprecated, in ARMv6. It is obsolete in ARMv7. For more information, see *Alignment* on page AppxG-6.

D.3.2 Ordering of instructions that change the CPSR interrupt masks

Any ARMv6 instruction that implicitly or explicitly changes the interrupt masks in the CPSR and appears in program order after a Strongly-ordered access must wait for the Strongly-ordered memory access to complete, see *Ordering of instructions that change the CPSR interrupt masks* on page AppxG-8 for more information.

ARMv6 deprecated any reliance on this behavior, and this behavior is obsoleted in ARMv7.

D.3.3 ARM LDM and POP instructions that both write back and load their base registers

LDM instructions and multi-register POP instructions that specify base register writeback and load their base register are permitted but deprecated before ARMv7, as described in *Different definition of some LDM and POP instructions* on page AppxG-15. Use of such instructions is obsolete in ARMv7.

D.4 Semaphore instructions

The ARM instruction set has two semaphore instructions:

- Swap (SWP)
- Swap Byte (SWPB).

These instructions are provided for process synchronization. Both instructions generate a load access and a store access to the same memory location, such that no other access to that location is permitted between the load access and the store access. This enables a memory semaphore to be loaded and altered without interruption.

SWP and SWPB have a single addressing mode, whose address is the contents of a register. Separate registers are used to specify the value to store and the destination of the load. If the same register is specified for both of these, SWP exchanges the value in the register and the value in memory.

The semaphore instructions do not provide a compare and conditional write facility. If wanted, this must be done explicitly.

Use of the swap and swap byte instructions is deprecated from ARMv6. ARM recommends that all software uses the LDREX and STREX synchronization primitives. For details see:

- *LDREX* on page A8-142
- *LDREXB* on page A8-144
- *LDREXD* on page A8-146
- *LDREXH* on page A8-148
- *STREX* on page A8-400
- *STREXB* on page A8-402
- *STREXD* on page A8-404
- *STREXH* on page A8-406.

D.5 Use of the SP as a general-purpose register

In the Thumb instruction set, you can only use the SP (R13) in a restricted set of instructions. This set covers all the legitimate uses of the SP as a stack pointer. An attempt to encode any other instruction with SP in place of a legitimate register results in either UNPREDICTABLE behavior, or a different instruction.

In addition, ~~the use of SP (R13) as Rm in the high-register forms of the 16-bit CMP and ADD instructions is deprecated. Also, some forms of MOV (register) that use SP are deprecated, see *MOV (register)* on page A8-196.~~



Most ARM instructions, unlike Thumb instructions, provide exactly the same access to the SP as to R0-R12. This means that it is possible to use the SP as a general-purpose register. However, the use of the SP in an ARM instruction, in any way that is not possible in the corresponding Thumb instruction, is deprecated.

See *ARM instructions where SP use is not deprecated* for a list of instructions that you can use for SP manipulation.

D.5.1 ARM instructions where SP use is not deprecated

The use of the SP is deprecated in any ARM instruction that is not specified in this section.

Some uses of the SP are not deprecated in the following ARM data-processing instructions:

- *ADD (SP plus immediate)* on page A8-28
- *ADD (SP plus register)* on page A8-30
- *CMN (immediate)* on page A8-74
- *CMN (register)* on page A8-76
- *CMP (immediate)* on page A8-80
- *CMP (register)* on page A8-82
- *MOV (register)* on page A8-196
- *SUB (SP minus immediate)* on page A8-426
- *SUB (SP minus register)* on page A8-428.

In these ARM instructions, the uses of the SP that are not deprecated are the same as those uses listed in *32-bit Thumb instruction support for R13* on page A6-4.

The use of the SP as the base register in load/store/preload instructions is not deprecated. In addition, the use of the SP as destination or source register is not deprecated in the following instructions:

- *LDR (immediate, ARM)* on page A8-120
- *LDR (literal)* on page A8-122
- *LDR (register)* on page A8-124
- *STR (immediate, ARM)* on page A8-384
- *STR (register)* on page A8-386.

D.6 Explicit use of the PC in ARM instructions

Most ARM instructions, unlike Thumb instructions, provide exactly the same access to the PC as to general-purpose registers. However, the explicit use of the PC in an ARM instruction is not usually useful, and except for specific instances that are useful, such use is deprecated.

———— **Note** ————

Implicit use of the PC, for example in branch instructions or load (literal) instructions, is never deprecated.

Table D-4 shows where ARM instructions can explicitly use the PC. All other explicit use of the PC is deprecated.

Table D-4 Non-deprecated uses of the PC in ARM instructions

Instruction	Non-deprecated use of PC
All load and preload instructions	As destination register or base register. ^a
<i>ADD (immediate, ARM)</i> on page A8-22	As destination register.
<i>ADD (register)</i> on page A8-24	As destination register, source register, or both.
<i>ADD (SP plus immediate)</i> on page A8-28	As destination register.
<i>ADR</i> on page A8-32	As destination register.
<i>MOV (register)</i> on page A8-196	As destination register or source register, but not both. ^b
<i>SUB (immediate, ARM)</i> on page A8-420	As destination register.
<i>SUB (register)</i> on page A8-422	As destination register.
<i>SUB (SP minus immediate)</i> on page A8-426	As destination register.
<i>SUB (SP minus register)</i> on page A8-428	As destination register.
<i>SUBS PC, LR and related instructions</i> on page B6-251	As destination register.

- a. Only if the instruction description permits the register to be the PC.
- b. Transfer of the PC to or update of the PC from the SP is deprecated.



D.7 Deprecated Thumb instructions

Most deprecated instructions are in the ARM instruction set. Deprecated Thumb instructions are:

- use of PC as <Rd> or <Rm> in a 16-bit ADD (SP plus register) instruction
- use of SP as <Rm> in a 16-bit ADD (SP plus register) instruction
- use of SP as <Rm> in a 16-bit CMP (register) instruction
- use of MOV (register) instructions in which both <Rd> and <Rm> are the SP or PC
- use of Rn as the lowest-numbered register in the register list of a 16-bit STM instruction with base register writeback.

Appendix E

Fast Context Switch Extension (FCSE)

This appendix describes the *Fast Context Switch Extension* (FCSE). It contains the following sections:

- *About the FCSE* on page AppxE-2
- *Modified virtual addresses* on page AppxE-3
- *Debug and trace* on page AppxE-5.

Note

- From ARMv6, use of the FCSE mechanism is deprecated. The FCSE is optional in ARMv7.
 - Use of both the FCSE and the ASID based memory attribute results in UNPREDICTABLE behavior. Either the FCSE must be cleared, or all memory declared as global.
-

E.1 About the FCSE

The *Fast Context Switch Extension* (FCSE) modifies the behavior of an ARM memory system. This modification permits multiple programs running on the ARM processor to use identical address ranges, while ensuring that the addresses they present to the rest of the memory system differ.

Normally, a swap between two software processes whose address ranges overlap requires changes to be made to the virtual-to-physical address mapping defined by the MMU translation tables, see *Translation tables* on page B3-7. It also typically causes cache and TLB contents to become invalid (because they relate to the old virtual-to-physical address mapping), and so requires caches and TLBs to be flushed. As a result, each process swap has a considerable overhead, both directly because of the cost of changing the translation tables and indirectly because of the cost of subsequently reloading caches and TLBs.

By presenting different addresses to the rest of the memory system for different software processes even when they are using identical addresses, the FCSE avoids this overhead. It also permits software processes to use identical address ranges even when the rest of the memory system does not support virtual-to-physical address mapping.

E.2 Modified virtual addresses

The 4GB virtual address space is divided into 128 process blocks, each of size 32MB. Each process block can contain a program that has been compiled to use the address range $0x00000000$ to $0x01FFFFFF$. For each of $i=0$ to 127, process block i runs from address $(i \times 0x02000000)$ to address $(i \times 0x02000000 + 0x01FFFFFF)$.

The FCSE processes each virtual address for a memory access generated by the ARM processor to produce a *modified virtual address*, that is sent to the rest of the memory system to be used in place of the normal virtual address. For an MMU-based memory system, the process is illustrated in Figure E-1:

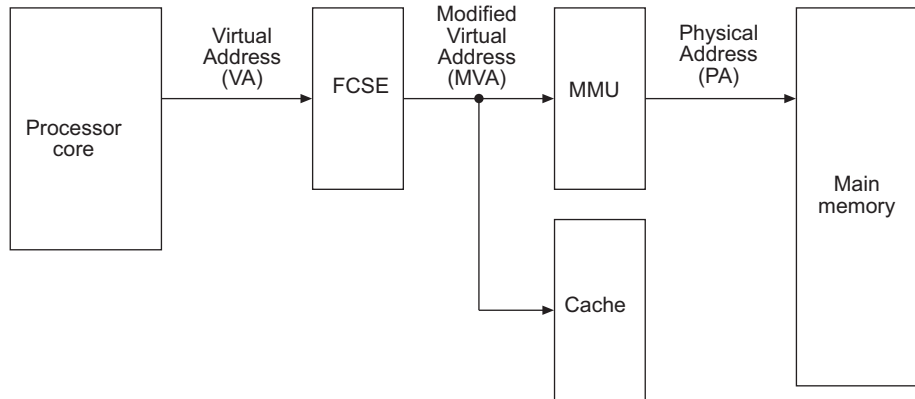

Figure E-1 Address flow in MMU memory system with FCSE

When the ARM processor generates a memory access, the translation of the Virtual Address (VA) into the Modified Virtual Address (MVA) is described by the `FCSETranslate()` function in *FCSE translation* on page B3-156.

When the top seven bits of the address are zero, the translation replaces these bits by the value of `FCSEIDR.PID` when they are zero, and otherwise the translation leaves the address unchanged. When `FCSEIDR.PID` has its reset value of `0b0000000`, the translation leaves the address unchanged, meaning that the FCSE is effectively disabled.

The value of `FCSEIDR.PID` is also known as the *FCSE process ID* of the current process. For more information, see *c13, FCSE Process ID Register (FCSEIDR)* on page B3-152.

The effect of setting the `FCSEIDR` to a nonzero value at a time when any translation table entries have enabled the alternative Context ID, ASID-based support (`nG bit == 1`) is UNPREDICTABLE. For more information about ASIDs see *About the VMSA* on page B3-2.

————— Note —————

Virtual addresses are sometimes passed to the memory system as data. For these operations, no address modification occurs, and $MVA = VA$.

Each process is compiled to use the address range 0x00000000 to 0x01FFFFFF. When referring to its own instructions and data, therefore, the program generates VAs whose top seven bits are all zero. The resulting MVAs have their top seven bits replaced by FCSEIDR.PID, and so lie in the process block of the current process.

The program can also generate VAs whose top seven bits are not all zero. When this happens, the MVA is equal to the VA. This enables the program to address the process block of another process, provided the other process does not have process ID 0. Provided access permissions are set correctly, this can be used for inter-process communication.

———— **Note** —————

ARM recommends that only process IDs 1 and above are used for general-purpose processes, because the process with process ID 0 cannot be communicated with in this fashion.

Use of the FCSE therefore reduces the cost of a process swap to:

- The cost of a write of the FCSEIDR.PID.
- The cost of changing access permissions if they need changing for the new process. In an MMU-based system, this might involve changing the translation table entries individually, or pointing to a new translation table by changing one or more of TTBR0, TTBR1, and TTBCR. Any change to the translation tables is likely to involve invalidation of the TLB entries affected. However, this is usually significantly cheaper than the cache flush that would be required without the FCSE. Also, in some cases, changes to the translation table, and the associated explicit TLB management, can be avoided by the use of domains. This reduces the cost to that of a write to the Domain Access Control Register, see *Domains* on page B3-31.

The FCSE is deprecated. The use of cache, branch predictor and TLB operations with MVA based addresses that, as a result of the Multiprocessing Extensions, would affect other processors as described in section 3.2 is UNPREDICTABLE if FCSEIDR.PID is not zero.

E.3 Debug and trace

It is IMPLEMENTATION DEFINED whether a VA or MVA is used by breakpoint and watchpoint mechanisms. However, ARM strongly recommends that any implementation that includes the FCSE uses MVAs, to avoid trigger aliasing.

Appendix F

VFP Vector Operation Support

This appendix provides reference information about VFP vector operation.

This appendix contains the following sections:

- *About VFP vector mode* on page AppxF-2
- *Vector length and stride control* on page AppxF-3
- *VFP register banks* on page AppxF-5
- *VFP instruction type selection* on page AppxF-7.

———— **Note** —————

The use of VFP vector mode is deprecated. This information is provided for backwards compatibility only.

F.1 About VFP vector mode

The single-precision registers can be used to hold short vectors of up to 8 single-precision values. Arithmetic operations on all the elements of such a vector can be specified by just one single-precision arithmetic instruction.

Similarly, the double-precision registers can be used to hold short vectors of up to 4 double-precision values, and double-precision arithmetic instructions can specify operations on these vectors.

A vector consists of 2-8 registers from a single *bank*. *VFP register banks* on page AppxF-5 describes the division of the VFP register set into banks.

The FPSCR.LEN field controls the number of elements in a vector. The register number in the instruction specifies the register that contains the first element of the vector. The FPSCR.STRIDE field controls the increment between the register numbers of the elements of the vector. If the total increment causes the register number to overflow the top of a register bank, the register number wraps around to the bottom of the bank, as shown in *VFP register banks* on page AppxF-5.

For details of the FPSCR.LEN and FPSCR.STRIDE fields see *Vector length and stride control* on page AppxF-3.

A VFP instruction can operate on:

- operand vectors with LEN elements, producing a result vector with LEN elements
- an operand vector with LEN elements and a scalar operand, producing a result vector with LEN elements
- scalar operands, producing a scalar result.

These three operation types are identical if $LEN == 1$.

To control which type of operation an instruction performs, you choose the registers for the instruction from different register banks. *VFP instruction type selection* on page AppxF-7 describes how to select the instruction type.

F.1.1 Affected instructions

The following VFP instructions are affected by VFP vector mode:

VABS	VADD	VDIV	VMLA	VMLS
VMOV (immediate)	VMOV (register)	VMUL	VNEG	VNMLA
VNMLS	VNMUL	VSQRT	VSUB	

All other VFP instructions behave as described in their instruction descriptions regardless of the values of FPSCR.LEN and FPSCR.STRIDE.

F.2 Vector length and stride control

The FPSCR.LEN field, bits [18:16], controls the vector length for VFP instructions that operate on short vectors, that is, how many registers are in a vector operand. Similarly, the FPSCR.STRIDE field, bits [21:20], controls the vector stride, that is, how far apart the registers in a vector lie in the register bank. For information about the FPSCR see *Floating-point Status and Control Register (FPSCR)* on page A2-28.

The permitted combinations of LEN and STRIDE are shown in Table F-1. All other combinations of LEN and STRIDE produce UNPREDICTABLE results.

The combination LEN == 0b000, STRIDE == 0b00 is called *scalar mode*. When it is in effect, all arithmetic instructions specify scalar operations. Otherwise, most arithmetic instructions specify a scalar operation if their destination is in the range:

- S0-S7 for a single-precision operation
- D0-D3 or D16-D19 for a double-precision operation.

The full rules used to determine which operands are vectors and full details of how vector operands are specified can be found in *VFP instruction type selection* on page AppxF-7.

The rules for vector operands do not permit the same register to appear twice or more in a vector. The permitted LEN and STRIDE combinations listed in Table F-1 never cause this to happen for single-precision instructions, so single-precision scalar and vector instructions can be used with all of these LEN and STRIDE combinations.

For double-precision vector instructions, some of the permitted LEN and STRIDE combinations would cause the same register to appear twice in a vector. If a double-precision vector instruction is executed with such a LEN and STRIDE combination in effect, the instruction is UNPREDICTABLE. The last column of Table 2-2 indicates which LEN and STRIDE combinations this applies to. Double-precision scalar instructions work normally with all of the permitted LEN and STRIDE combinations.

Table F-1 Vector length and stride combinations

LEN	STRIDE	Vector length	Vector stride	Double-precision vector instructions
0b000	0b00	1	-	All instructions are scalar
0b001	0b00	2	1	Work as described in this appendix
0b001	0b11	2	2	Work as described in this appendix
0b010	0b00	3	1	Work as described in this appendix
0b010	0b11	3	2	UNPREDICTABLE
0b011	0b00	4	1	Work as described in this appendix
0b011	0b11	4	2	UNPREDICTABLE
0b100	0b00	5	1	UNPREDICTABLE

Table F-1 Vector length and stride combinations (continued)

LEN	STRIDE	Vector length	Vector stride	Double-precision vector instructions
0b101	0b00	6	1	UNPREDICTABLE
0b110	0b00	7	1	UNPREDICTABLE
0b111	0b00	8	1	UNPREDICTABLE

F.3 VFP register banks

The Advanced SIMD and VFP registers are divided into banks as follows:

- The single-precision registers are divided into four banks of eight. This is shown in Figure F-1. The first bank is a *scalar* bank, and the other three are *vector* banks.
- In a processor with 32 double-precision registers, the double-precision registers are divided into eight banks of four. This is shown in Figure F-2. The first and fifth banks are scalar banks, and the other six are vector banks.
- In a processor with 16 double-precision registers, the double-precision registers are divided into four banks of four. This is shown in Figure F-3 on page AppxF-6. The first bank is a scalar bank, and the other three are vector banks.

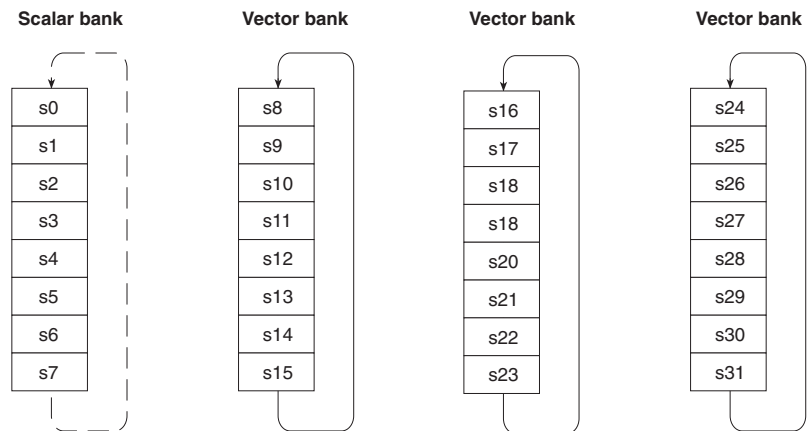

Figure F-1 Single-precision register banks

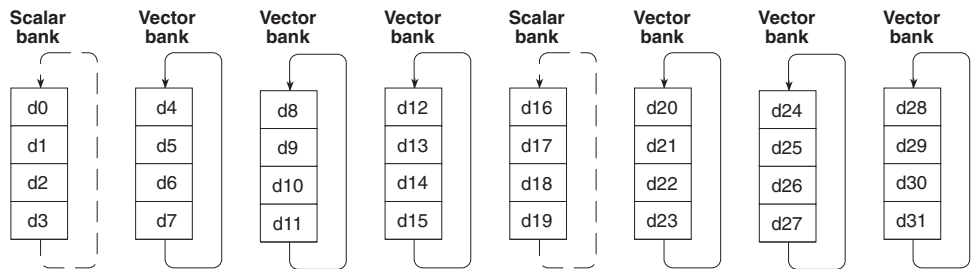

Figure F-2 Register banks, 32 double-precision register VFP

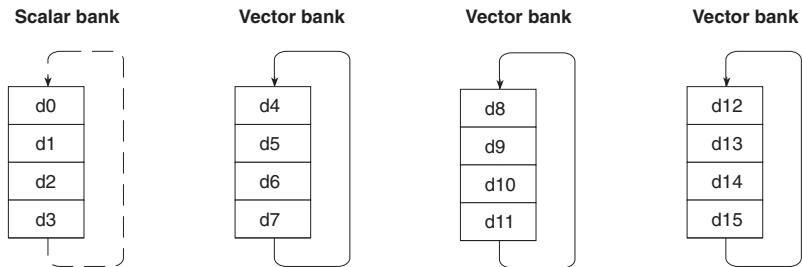

Figure F-3 Register banks, 16 double-precision register VFP

F.4 VFP instruction type selection

Table F-2 shows how the selection of registers in an instruction controls the operation of the instruction.

Table F-2

Destination register bank	1st operand bank	2nd operand bank	Destination type	1st operand type	2nd operand type
Scalar	Any	Any	Scalar	Scalar	Scalar
Vector	Any	Scalar	Vector	Vector	Scalar
Vector	Any	Vector	Vector	Vector	Vector
Scalar	Any	None	Scalar	Scalar	-
Vector	Scalar	None	Vector	Scalar	-
Vector	Vector	None	Vector	Vector	-

- If the instruction has two operands:
 - If the destination register is in a scalar register bank, the operands and result are all scalars.
 - If the destination register is in a vector register bank and the second operand is in a scalar bank, the second operand is a scalar, but both the destination and the first operand are vectors. Each element of the result is produced by an operation on the corresponding element of the first operand and the same scalar.
 - If the destination register and the second operand are both in vector register banks, the operands and result are all vectors. Each element of the result is produced by an operation on corresponding elements of both operands.
- If the instruction has one operand:
 - If the destination register is in a scalar register bank, the operand and result are both scalars.
 - If the destination register is in a vector register bank and the operand is in a scalar bank, the result is a vector and the operand is a scalar. The result is duplicated to each element of the destination vector.
 - If the destination register and the operand are both in vector register banks, the operand and result are both vectors. Each element of the result is produced by an operation on the corresponding element of the operand.

Some VFP instructions have three operands, but in these cases one of the operand vectors is also the result vector. They operate in the same way as two operand instructions.

Appendix G

ARMv6 Differences

This appendix describes how ARMv6 differs from ARMv7. The appendix contains the following sections:

- *Introduction to ARMv6* on page AppxG-2
- *Application level register support* on page AppxG-3
- *Application level memory support* on page AppxG-6
- *Instruction set support* on page AppxG-10
- *System level register support* on page AppxG-16
- *System level memory model* on page AppxG-20
- *System Control coprocessor (CP15) support* on page AppxG-29.

Note

In this appendix, the description ARMvN refers to all architecture variants of ARM architecture vN described in this manual. In particular, ARMv6 refers to ARMv6, ARMv6K, and ARMv6T2, including ARMv6K with the Security Extensions. Where the description ARMvN also describes a specific architecture variant, this variant is sometimes described as the *base architecture*, for example the ARMv6 base architecture.

G.1 Introduction to ARMv6

This appendix describes the differences in the ARMv6 architecture, compared to the description of ARMv7 given in parts A and B of this manual. Key changes introduced in ARMv7 are:

- Introduction of hierarchical cache support.
- Formalizing the alternative memory system architectures into different architecture profiles:
 - the *Virtual Memory System Architecture* (VMSA) is formalized into the ARMv7-A profile
 - the *Protected Memory System Architecture* (PMSA) is formalized into the ARMv7-R profile.
- Introduction of the Advanced SIMD extensions.
- Introduction of the Thumb Execution Environment (ThumbEE). ThumbEE is required in ARMv7-A, and optional in ARMv7-R.

This appendix summarizes the features supported in ARMv6, highlighting:

- the similarities and differences with respect to ARMv7, including the following architecture variants and extensions:
 - the Security Extensions
 - the extension of the Thumb instruction set using Thumb-2 technology, introduced in ARMv6T2
 - the enhanced kernel support introduced in ARMv6K.
- legacy support for ARMv4 and ARMv5.

G.1.1 Debug

Part C of this manual describes ARMv6 Debug, ARMv7 Debug, and the differences between them.

G.2 Application level register support

The ARMv6 core registers are the same as the ARMv7 core registers. For more information, see *ARM core registers* on page A2-11. The following sections give more information about ARMv6 application level register support:

- *APSR support*
- *Instruction set state.*

G.2.1 APSR support

Application Program Status Register (APSR) support in ARMv6 is identical to ARMv7. Program status is reported in the 32-bit APSR. The format of the APSR is:

31	30	29	28	27	26	24	23	20	19	16	15	0
N	Z	C	V	Q	RAZ/ SBZP	Reserved		GE[3:0]		Reserved		

See *The Application Program Status Register (APSR)* on page A2-14 for the APSR bit definitions.

Earlier versions of this manual do not use the term APSR. They refer to the APSR as the CPSR with restrictions on reserved fields determined by whether the access to the register was privileged or not.

G.2.2 Instruction set state

Instruction set state support in ARMv6 is in general the same as the support available in ARMv7. The only differences are that:

- ThumbEE state is not supported in ARMv6. It is introduced in ARMv7.
- In ARMv6 and ARMv6K, but not in ARMv6T2, when the processor is in a privileged mode you must take care not to attempt to change the instruction set state by writing nonzero values to CPSR.J and CPSR.T with an MSR instruction. For more information, see *Format of the CPSR and SPSRs* on page AppxG-17.

All ARMv6 implementations support the ARM instruction set. The ARMv6 base architecture and ARMv6K also support a subset of the Thumb instruction set that can be executed entirely as 16-bit instructions. The only 32-bit instructions in this subset are restricted-range versions of the BL and BLX (immediate) instructions. See *BL and BLX (immediate) instructions, before ARMv6T2* on page AppxG-4 for a description of how these instructions can be executed as 16-bit instructions.

The supported ARM and Thumb instructions in the ARMv6 base architecture and ARMv6K are summarized in *Instruction set support* on page AppxG-10, and the instruction descriptions in Chapter A8 *Instruction Details* give details of the architecture variants that support each instruction encoding.

Jazelle state is supported as in ARMv7. For more information, see:

- *Jazelle direct bytecode execution support* on page A2-73, for application level information
- *Jazelle direct bytecode execution* on page B1-74, for system level information.

ARMv6T2 supports the full Thumb instruction set, apart from a few instructions that are introduced in ARMv7.

Interworking

In ARMv6, the instructions that provide interworking branches between ARM and Thumb states are:

- BL and BLX
- LDR, LDM, and POP instructions that load the PC.

In ARMv7, the following ARM instructions also perform interworking branches if their destination register is the PC and the 'S' option is not specified:

- ADC, ADD, AND, ASR, BIC, EOR, LSL, LSR, MOV, MVN, ORR, ROR, RRX, RSB, RSC, SBC, and SUB.

The instructions do not perform interworking branches in ARMv6, and the corresponding Thumb instructions do not perform interworking branches in either ARMv6 or ARMv7. This functionality is described by the `ALUWritePC()` pseudocode function. See *Pseudocode details of operations on ARM core registers* on page A2-12.

BL and BLX (immediate) instructions, before ARMv6T2

In ARMv4T, ARMv5T, ARMv5TE, ARMv5TEJ, ARMv6, and ARMv6K, the BL and BLX (immediate) instructions are the only 32-bit Thumb instructions, and the maximum range of the branches that they specify is restricted to approximately +/-4MB. This means that each of the two halfwords of these instructions has top five bits 0b11101, 0b11110, or 0b11111, and makes it possible to execute the two halfwords as separate 16-bit instructions.

The following descriptions use the format described in *Instruction encodings* on page A8-2, except that they:

- name the encodings H1, H2 and H3
- have pseudocode that defines the entire operation of the instruction, instead of separate encoding-specific pseudocode and Operation pseudocode.

When the two halfwords of a BL or BLX (immediate) instruction are executed separately, their behavior is as follows:

Encoding H1	ARMv4T, ARMv5T*, ARMv6, ARMv6K	Used for BL and BLX
BL{X} <label>		First of two 16-bit instructions

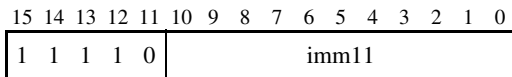

LR = PC + SignExtend(imm11:Zeros(12), 32);

Encoding H2 ARMv4T, ARMv5T*, ARMv6, ARMv6K Used for BL
 BL <label> Second of two 16-bit instructions

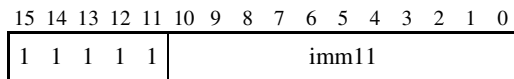

```
next_instr_addr = PC - 2;
BranchWritePC(LR + ZeroExtend(imm11:'0', 32));
LR = next_instr_addr<31:1> : '1';
```

Encoding H3 ARMv5T*, ARMv6, ARMv6K Used for BLX
 BLX <label> Second of two 16-bit instructions

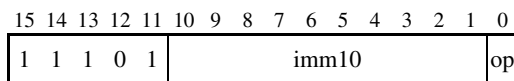

```
if op == '0' then
  next_instr_addr = PC - 2;
  SelectInstrSet(InstrSet_ARM);
  BranchWritePC(Align(LR,4) + ZeroExtend(imm10:'00', 32));
  LR = next_instr_addr;
else
  UNDEFINED;
```

An encoding H1 instruction must be followed by an encoding H2 or encoding H3 instruction. Similarly, an encoding H2 or encoding H3 instruction must be preceded by an encoding H1 instruction. Otherwise, the behavior is UNPREDICTABLE.

It is IMPLEMENTATION DEFINED whether processor exceptions can occur between the two instructions of a BL or BLX pair. If they can, the ARM exception return instructions must be able to return correctly to the second instruction of the pair. The exception handler does not have to take special precautions. See *Exception return* on page B1-38 for the definition of exception return instructions.

————— **Note** —————

There are no Thumb exception return instructions in the architecture versions that support separate execution of the two halfwords of BL and BLX (immediate) instructions. Also, the ARM RFE instruction is only defined from ARMv6 onwards.

G.3 Application level memory support

Memory support covers address alignment, endian support, semaphore support, memory order model, caches, and write buffers. The following sections give an application level description of ARMv6 memory support:

- *Alignment*
- *Endian support* on page AppxG-7
- *Semaphore support* on page AppxG-8
- *Memory model and memory ordering* on page AppxG-8.

G.3.1 Alignment

ARMv6 supports:

- a legacy alignment configuration compatible with ARMv5
- the ARMv7 alignment configuration that supports unaligned loads and stores of 16-bit halfwords and 32-bit words.

The alignment configuration is controlled by the SCTL.R.U bit, see *c1, System Control Register (SCTLR)* on page AppxG-34:

SCTL.R.U == 0

ARMv5 compatible alignment support, see *Alignment* on page AppxH-6, except for the LDRD and STRD instructions. LDRD and STRD must be doubleword-aligned, otherwise:

- if SCTL.R.A == 0, the instruction is UNPREDICTABLE
- if SCTL.R.A == 1, the instruction causes an Alignment fault.

————— Note —————

The behavior of LDRD and STRD with SCTL.R.A == 0 is compatible with ARMv5. When SCTL.R.A == 1, whether the alignment check is for word or doubleword alignment is:

- IMPLEMENTATION DEFINED in ARMv5
- required to be for doubleword alignment in ARMv6.

SCTL.R.U == 1

Unaligned access support for loads and stores of single 16-bit halfwords and 32-bit words, using the LDR, LDRH, LDRHT, LDRSH, LDRSHT, LDRT, STRH, STRHT, STR, and STRT instructions. Some of these instructions were introduced in ARMv6T2.

The following requirements also apply:

- LDREX and STREX exclusive access instructions must be word-aligned, otherwise the instruction generates an abort.
- In ARMv6K, an abort is generated if:
 - an LDREXH or STREXH exclusive access instruction is not halfword-aligned
 - an LDREXD or STREXD exclusive access instruction is not doubleword-aligned.

- SWP must be word-aligned, otherwise the instruction generates an abort. From ARMv6, use of the SWP instruction is deprecated.
- All multi-word load/store instructions must be word-aligned, otherwise the instruction generates an abort.
- Unaligned access support only applies to Normal memory. Unaligned accesses to Strongly-ordered or Device memory are UNPREDICTABLE.

In both configurations, setting the SCTL.RA bit forces an abort on an unaligned access.

———— **Note** —————

In ARMv7, SCTL.RU is always set to 1. ARMv7 alignment support is the same as ARMv6K in this configuration.

In common with ARMv7, all instruction fetches must be aligned.

G.3.2 Endian support

ARMv6 supports the same *Big Endian* (BE) and *Little Endian* (LE) support model as ARMv7, see *Endian support* on page A3-7. It is IMPLEMENTATION DEFINED if the legacy big endian model (BE-32) defined for ARMv4 and ARMv5 is also supported. For more information about BE-32 see *Endian support* on page AppxH-7.

For configuration and control information, see *Endian configuration and control* on page AppxG-20.

BE-32 DBGWCR Byte address select values

Using the BE-32 endian model changes the meaning of the Byte address select values in DBGWCR[8:5], described in *Watchpoint Control Registers (DBGWCR)* on page C10-61. When using BE-32 endianness, use Table G-1 to interpret these values. Do not use Table C10-13 on page C10-65.

Table G-1 Byte address select values, word-aligned address, ARMv6 BE-32 endianness

DBGWCR[8:5] value	Description
0000	Watchpoint never hits
xxx1	Watchpoint hits if byte at address DBGWVR<31:2>:'11' is accessed
xx1x	Watchpoint hits if byte at address DBGWVR<31:2>:'10' is accessed
x1xx	Watchpoint hits if byte at address DBGWVR<31:2>:'01' is accessed
1xxx	Watchpoint hits if byte at address DBGWVR<31:2>:'00' is accessed

G.3.3 Semaphore support

ARM deprecates the use of the ARM semaphore instructions SWP and SWPB, in favour of the exclusive access mechanism described in *Synchronization and semaphores* on page A3-12:

- ARMv6 and ARMv6T2 support the LDREX and STREX instructions
- ARMv6K and ARMv7 add the CLREX, LDREXB, LDREXD, LDREXH, STREXB, STREXD, and STREXH instructions.

All Load-Exclusive and Store-Exclusive access instructions must be naturally aligned. An unaligned Exclusive access instruction generates an unaligned access Data Abort exception.

G.3.4 Memory model and memory ordering

The memory model was formalized in ARMv6. This included:

- defining Normal, Device, and Strongly-ordered memory types
- adding a Shareable memory attribute
- extending the memory attributes to support two cache policies, associated with Inner and Outer levels of cache and including a write allocation hint capability
- adding *Data Memory Barrier* (DMB) and *Data Synchronization Barrier* (DSB) operations, to support the formalized memory ordering requirements
- adding an *Instruction Synchronization Barrier* (ISB) operation, to guarantee that instructions complete before any instructions that come after them in program order are executed.

ARMv6 provided barrier operations as CP15 c7 operations. These migrated to the ARM and Thumb instruction sets as follows:

- ARMv6 required DMB, DSB, and ISB operations in CP15, see *c7, Miscellaneous functions* on page AppxH-51. The functionality of these operations is the same as that described for ARMv7 in *Memory barriers* on page A3-47.
- ARMv7 adds DMB, DSB, and ISB instructions to the ARM and Thumb instruction sets.

ARM deprecates use of the CP15 barrier operations.

Ordering of instructions that change the CPSR interrupt masks

In ARMv6, any instruction that implicitly or explicitly changes the interrupt masks in the CPSR and appears in program order after a Strongly-ordered access must wait for the Strongly-ordered memory access to complete. These instructions are:

- An MSR with the control field mask bit set.
- The flag-setting variants of arithmetic and logical instructions with the PC as the destination register. These instructions copy the SPSR to CPSR.

ARM deprecates any reliance on this behavior, and this behavior is obsolete from ARMv7. Instead, when synchronization is required, include an explicit memory barrier between the memory access and the following instruction, see *Data Synchronization Barrier (DSB)* on page A3-49.

Caches and write buffers

For details of cache support in ARMv6, see *Cache support* on page AppxG-21.

Tightly Coupled Memory (TCM) support

TCM provides low latency memory that the processor can use without the unpredictability of caches. TCM can hold critical routines, scratchpad data, or data types with locality properties that are not suitable for caching. An implementation can use TCM at the application or at the system level. For more information about ARMv6 TCM support see *Tightly Coupled Memory (TCM) support* on page AppxG-23.

DMA support

Direct Memory Access (DMA) enables a peripheral to read and write data directly from and to main memory. In ARMv6, the coherency of DMA and processor memory accesses is IMPLEMENTATION DEFINED. DMA support for TCM is IMPLEMENTATION DEFINED.

G.4 Instruction set support

Two instruction sets are supported in ARMv6:

- the ARM instruction set
- the Thumb instruction set.

ARMv6 floating-point support, known as VFPv2, is the same as that supported in ARMv5. The instructions use coprocessors 10 and 11 and are documented with all other instructions in *Alphabetical list of instructions* on page A8-14. The following VFP instructions are not supported in ARMv6. These instructions are introduced in ARMv7 (VFPv3):

- VM0V (immediate)
- VCVT (between floating-point and fixed-point).

Note

- VFP instruction mnemonics traditionally started with an F. However this has been changed to a V prefix in the Unified Assembler Language introduced in ARMv6T2, and in many cases the rest of the mnemonic has been changed to be more compatible with other instructions mnemonics. This aligns the scalar floating-point support with the ARMv7 Advanced SIMD support, which shares some load/store and move operations to a common register file.
 - The VFPv2 instructions are summarized in *F* (former VFP instruction mnemonics)* on page A8-100. This includes the two deprecated instructions in VFPv2 that do not have UAL mnemonics, the FLDMM and FSTMX instructions.
-

ARMv6 introduces new instructions in addition to supporting all the ARM and Thumb instructions available in ARMv5TEJ. For more information, see *Instruction set support* on page AppxH-11, *ARM instruction set support* on page AppxG-11, and *Thumb instruction set support* on page AppxG-14.

The ARM and Thumb instruction sets grew significantly in ARMv6 and ARMv6T2, compared with ARMv5TEJ, mainly because of:

- the development of ARMv6 SIMD
- the addition of many 32-bit Thumb instructions in ARMv6T2.

ARMv6K adds some kernel support instructions. It also permits the use of the optional Security Extensions and the SMC instruction.

ARMv7 extends the instruction sets as defined for ARMv6 and the ARMv6 architecture variants and extensions as follows:

- the introduction of barrier instructions to the ARM and Thumb instruction sets
- the ThumbEE extension in ARMv7
- the new instructions added in VFPv3
- the Advanced SIMD extension in ARMv7.

Note

This appendix describes the instructions included as a mnemonic in ARMv6. For any mnemonic, to determine which associated instruction encodings appear in a particular architecture variant, see the subsections of *Alphabetical list of instructions* on page A8-14 that describe the mnemonic. Each encoding diagram shows the architecture variants or extensions that include the encoding.

The following sections give more information about ARMv6 instruction set support:

- *ARM instruction set support*
- *Thumb instruction set support* on page AppxG-14
- *System level instruction set support* on page AppxG-14.

G.4.1 ARM instruction set support

ARMv6 includes all the ARM instructions present in ARMv5TEJ, see *ARM instruction set support* on page AppxH-12. Table G-2 shows the ARM instruction changes in the ARMv6 base architecture.

Table G-2 ARM instruction changes in ARMv6

Instruction	ARMv6 change
CPS	Introduced
LDREX	Introduced
MCRR2	Introduced
MRRC2	Introduced
PKH	Introduced
QADD16	Introduced
QADD8	Introduced
QASX	Introduced
QSUB16	Introduced
QSUB8	Introduced
QSAX	Introduced
REV, REV16, REVSH	Introduced
RFE	Introduced
SADD8, SADD16, SASX	Introduced
SEL	Introduced

Table G-2 ARM instruction changes in ARMv6 (continued)

Instruction	ARMv6 change
SETEND	Introduced
SHADD8, SHADD16	Introduced
SHSUB8, SHSUB16	Introduced
SMLAD	Introduced
SMLALD	Introduced
SMLSD	Introduced
SMLSLD	Introduced
SMMLA	Introduced
SMMLS	Introduced
SMMUL	Introduced
SMUAD	Introduced
SMUSD	Introduced
SRS	Introduced
SSAT, SSAT16	Introduced
SSUB8, SSUB16, SSAX	Introduced
STREX	Introduced
SWP	Deprecated
SWPB	Deprecated
SXTAB, SXTAB16, SXTAH	Introduced
SXTB, SXTB16, SXTH	Introduced
UADD8, UADD16, UASX	Introduced
UHADD8, UHADD16, UHASX	Introduced
UHSUB8, UHSUB16, UHSAX	Introduced
UMAAL	Introduced
UQADD8, UQADD16, UQASX	Introduced

Table G-2 ARM instruction changes in ARMv6 (continued)

Instruction	ARMv6 change
UQSUB8, UQSUB16, UQSAX	Introduced
USAD8, USADA8	Introduced
USAT, USAT16	Introduced
USUB8, USUB16, USAX	Introduced
UXTAB, UXTAB16, UXTAH	Introduced
UXTB, UXTB16, UXTH	Introduced

The SMC instruction is added as part of the Security Extensions.

The CLREX, LDREXB, LDREXD, LDREXH, NOP, SEV, STREXB, STREXD, STREXH, WFE, WFI, and YIELD instructions are added with the enhanced kernel support as part of ARMv6K.

New ARM instructions in ARMv6T2

ARMv6T2 adds the following ARM instructions:

BFC, BFI, LDRHT, LDRSBT, LDRSHT, MLS, MOVT, RBIT, SBFX, STRHT, and UBFX.

Instructions that are only in the ARM instruction set in ARMv6T2

The following ARM instructions have no Thumb equivalents in ARMv6T2:

- register-shifted forms of the ADC, ADD, AND, BIC, CMN, CMP, EOR, MVN, ORR, RSB, SBC, SUB, TEQ, and TST instructions
- all forms of the RSC instruction
- LDMDA, LDMIB, STMDA, and STMIB
- SWP and SWPB.

ARM instructions introduced in ARMv7

The DMB, DSB, ISB, PLI, SDIV, and UDIV instructions are added in ARMv7 and are not present in any form in ARMv6. The SDIV and UDIV instructions are not present in ARMv7-A.

The DBG hint instruction is added in ARMv7. It is UNDEFINED in the ARMv6 base architecture, and executes as a NOP instruction in ARMv6K and ARMv6T2.

G.4.2 Thumb instruction set support

ARMv6 includes all the Thumb instructions present in ARMv5TE, see *Thumb instruction set support* on page AppxH-15. the 16-bit Thumb instructions added in the ARMv6 base architecture are:

- CPS
- CPY
- REV, REV16, REVSH
- SETEND
- SXTB, SXTH
- UXTB, UXTH.

Thumb instruction set and ARMv6T2

From the ARMv6T2 version of the Thumb instruction set:

- The Thumb instruction set provides 16-bit and 32-bit instructions that are executed in Thumb state.
- Most forms of ARM instructions have an equivalent Thumb encoding. *Instructions that are only in the ARM instruction set in ARMv6T2* on page AppxG-13 lists the exceptions to this in ARMv6T2.

The CBZ, CBNZ, and IT instructions are only in the Thumb instruction set and are introduced in ARMv6T2.

Before ARMv6T2, a BL or BLX (immediate) Thumb instruction can be executed as a pair of 16-bit instructions, rather than as a single 32-bit instruction. For more information, see *BL and BLX (immediate) instructions, before ARMv6T2* on page AppxG-4. From ARMv6T2 these instructions are always executed as a single 32-bit instruction.

From ARMv6T2, the branch range of the BL and BLX (immediate) instructions is increased from approximately $\pm 4\text{MB}$ to approximately $\pm 16\text{MB}$.

Thumb instructions introduced in ARMv7

The CLREX, LDREXB, LDREXD, LDREXH, STREXB, STREXD, and STREXH instructions are added to the Thumb instruction set in ARMv7. They are Thumb equivalents to the ARM instructions added in ARMv6K. These instructions are UNDEFINED in ARMv6T2.

The DBG, SEV, WFE, WFI, and YIELD hint instructions are added in ARMv7. They execute as NOP instructions in ARMv6T2. The 16-bit encodings of the SEV, WFE, WFI, and YIELD instructions are UNDEFINED in the ARMv6 base architecture and in ARMv6K.

G.4.3 System level instruction set support

The system instructions supported in ARMv6 are the same as those listed for ARMv7 in *Alphabetical list of instructions* on page B6-2:

- the SMC instruction only applies to the Security Extensions
- the VMRS and VMSR instructions only apply to VFP.

G.4.4 Different definition of some LDM and POP instructions

This difference applies to:

- LDM instructions that have the base register in the register list and specify base register writeback
- POP instructions that load at least two registers, including the base register SP.

In ARMv6, ARM instructions of these types made the value of the base register UNKNOWN, and Thumb instructions of these types were UNPREDICTABLE. Use of ARM instructions of these types is deprecated.

In ARMv7, all instructions of these types are UNPREDICTABLE.

G.5 System level register support

The general registers and processor modes are the same as ARMv7, except that the Security Extensions and Monitor mode are permitted only in ARMv6K. For more information, see Figure B1-1 on page B1-9. The following sections give information about ARMv6 system level register support:

- *Program Status Registers (PSRs)*
- *The exception model* on page AppxG-18
- *Execution environment support* on page AppxG-19.

G.5.1 Program Status Registers (PSRs)

The application level programmers' model provides the Application Program Status Register, see *APSR support* on page AppxG-3. This is an application level alias for the *Current Program Status Register* (CPSR). The system level view of the CPSR extends the register, adding state that:

- is used by exceptions
- controls the processor mode.

Each of the exception modes has its own saved copy of the CPSR, the *Saved Program Status Register* (SPSR), as shown in Figure B1-1 on page B1-9. For example, the SPSR for Monitor mode is called SPSR_mon.

The Current Program Status Register (CPSR)

The CPSR holds the following processor status and control information:

- The APSR, see *APSR support* on page AppxG-3.
- The current instruction set state. See *ISSETSTATE* on page A2-15, except that ThumbEE state is not supported in ARMv6.
- The current endianness, see *ENDIANSTATE* on page A2-19.
- The current processor mode.
- Interrupt and asynchronous abort disable bits.
- In ARMv6T2, the execution state bits for the Thumb If-Then instruction, see *ITSTATE* on page A2-17.

The non-APSR bits of the CPSR have defined reset values. These are shown in the `TakeReset()` pseudocode function described in *Reset* on page B1-48, except that before ARMv6T2:

- CPSR.IT[7:0] are not defined and so do not have reset values
- the reset value of CPSR.T is 0.

The rules described in *The Current Program Status Register (CPSR)* on page B1-14 about when mode changes take effect apply with the modification that the ISB can only be the ISB operation described in *c7, Miscellaneous functions* on page AppxG-44.

The Saved Program Status Registers (SPSRs)

The SPSRs are defined as they are in ARMv7, see *The Saved Program Status Registers (SPSRs)* on page B1-15, except that the IT[7:0] bits are not implemented before ARMv6T2.

Format of the CPSR and SPSRs

The format of the CPSR and SPSRs is the same as ARMv7:

31	30	29	28	27	26	25	24	23	20	19	16	15	10	9	8	7	6	5	4	0	
N	Z	C	V	Q	IT [1:0]	J	Reserved	GE[3:0]	IT[7:2]				E	A	I	F	T	M[4:0]			

In ARMv6T2, the definitions and general rules for PSR bits and support of *Non-Maskable Fast Interrupts* (NMFI) are the same as ARMv7. For more information, see *Format of the CPSR and SPSRs* on page B1-16 and *Non-maskable fast interrupts* on page B1-18.

ARMv6 and ARMv6K have the following differences:

- Bits[26:25] are RAZ/WI.
- Bits[15:10] are reserved.
- The J and T bits of the CPSR must not be changed when the CPSR is written by an MSR instruction, or else the behavior is UNPREDICTABLE. MSR instructions exist only in ARM state in these architecture variants, so this is equivalent to saying the MSR instructions in privileged modes must treat these bits as SBZP. MSR instructions in User mode still ignore writes to these bits.

G.5.2 The exception model

The exception vector offsets and priorities as stated in *Offsets from exception base addresses* on page B1-31 and *Exception priority order* on page B1-33 are the same for ARMv6 and ARMv7.

See *Exception return* on page B1-38 for the definition of exception return instructions.

The ARM abort model

ARMv6 and ARMv7 use a *Base Restored Abort Model* (BRAM), as defined in *The ARM abort model* on page AppxH-20.

Exception entry

Entry to exceptions in ARMv6 is generally as described in the sections:

- *Reset* on page B1-48
- *Undefined Instruction exception* on page B1-49
- *Supervisor Call (SVC) exception* on page B1-52
- *Secure Monitor Call (SMC) exception* on page B1-53
- *Prefetch Abort exception* on page B1-54
- *Data Abort exception* on page B1-55
- *IRQ exception* on page B1-58
- *FIQ exception* on page B1-60.

These ARMv7 descriptions are modified as follows:

- pseudocode statements that set registers, bits and fields that do not exist in the ARMv6 architecture variant are ignored
- CPSR.T is set to SCTLR.TE in ARMv6T2, as described by the pseudocode, but to 0 in ARMv6 and ARMv6K.

Fault reporting

In previous ARM documentation, in descriptions of exceptions associated with memory system faults, the terms precise and imprecise are used instead of synchronous and asynchronous. For details of the terminology used to describe exceptions in ARMv7, see *Terminology for describing exceptions* on page B1-4.

ARMv6 only supports synchronous reporting of external aborts on instruction fetches and translation table walks. In ARMv7, these faults can be reported as synchronous or asynchronous aborts. Asynchronous aborts are always reported as Data Abort exceptions.

Two fault status encodings are deprecated in ARMv6:

- 0b00011 was assigned as an alignment error encoding and is re-assigned as an Access Flag section fault in ARMv6K and ARMv7
- 0b01010 was assigned as an external abort encoding and is a reserved value in ARMv7.

ARMv6 and ARMv7 provide alternative alignment and synchronous external abort error encodings that are common to both versions of the architecture.

G.5.3 Execution environment support

In ARMv6, the JOSCR.CV bit is not changed on exception entry in any implementation of Jazelle.

G.6 System level memory model

The pseudocode listed in *Aligned memory accesses* on page B2-31 and *Unaligned memory accesses* on page B2-32 covers the alignment behavior of all architecture variants from ARMv4. ARMv6 supports two alignment models, and the SCTL.R.U bit controls the alignment configuration. For more information, see *Alignment* on page AppxG-6.

————— Note —————

- ARMv4 and ARMv5 only support the SCTL.R.U = 0 alignment model.
- ARMv7 only supports the SCTL.R.U = 1 alignment model.

The following sections describe the system level memory model:

- *Endian configuration and control*
- *Cache support* on page AppxG-21
- *Tightly Coupled Memory (TCM) support* on page AppxG-23
- *Virtual memory support* on page AppxG-24
- *Protected Memory System Architecture (PMSA)* on page AppxG-28.

G.6.1 Endian configuration and control

Endian control and configuration is supported by two bits in the CP15 SCTL.R, and a PSR flag bit:

SCTL.R.B	BE-32 configuration bit. This bit must be RAZ/WI when BE-32 is not supported. BE-32 is the legacy big endian model. See <i>Endian support</i> on page AppxG-7.
SCTL.R.EE	This bit is used to update CPSR.E on exception entry and provide endian model information for translation table walks.
CPSR.E	The flag is updated on exception entry to the value of the SCTL.R.EE bit. Otherwise it is controlled by the SETEND instruction. Writing the bit using an MSR instruction is deprecated in ARMv6.

————— Note —————

BE and BE-32 are mutually exclusive. When SCTL.R.B is set, SCTL.R.EE and CPSR.E must be clear, otherwise the endian behavior is UNPREDICTABLE.

Endian behavior can be configured on reset using the **CFGEND[1:0]** pins. Table G-3 on page AppxG-21 defines the **CFGEND[1:0]** encoding and associated configurations.

Table G-3 Configuration options on reset

CFGEND[1:0]	CP15 System Control Register, SCTLR				PSR
	EE bit	U bit	A bit	B bit	E bit
00	0	0	0	0	0
01 ^a	0	0	0	1	0
10	0	1	0	0	0
11	1	1	0	0	1

a. This configuration is reserved in implementations that do not support BE-32. In this case, the B bit is RAZ.

Note

When an implementation does not include the **CFGEND[1:0]** signal, a value of 0b00 is assumed.

ARMv6 does not support the static instruction endianness configuration feature described in *Instruction endianness static configuration, ARMv7-R only* on page A3-9.

G.6.2 Cache support

ARMv7 can detect and manage a multi-level cache topology. ARMv6 only detects and manages level 1 caches, and the cache type is stored in the Cache Type Register. See *c0, Cache Type Register (CTR)* on page AppxH-35.

In ARMv6, the L1 cache must appear to software to behave as follows:

- the entries in the cache do not need to be cleaned, invalidated, or cleaned and invalidated by software for different virtual to physical mappings
- for memory regions that are described in the page tables as being Cacheable, aliases to the same physical address can exist, subject to the restrictions for 4KB small pages described in *Virtual to physical translation mapping restrictions* on page AppxG-26.

Note

These requirements are different from the required ARMv7 cache behavior described in *Address mapping restrictions* on page B3-23.

ARMv6 defines a standard set of cache operations for level 1 instruction, data, and unified caches. The cache operations required are:

- for an instruction cache:
 - invalidate all entries
 - invalidate entries by *Modified Virtual Address (MVA)*
 - invalidate entries by set/way
- for a data cache:
 - invalidate all entries, clean all entries
 - invalidate entries by MVA, clean entries by MVA
 - invalidate entries by set/way, clean entries by set/way
- for a unified cache:
 - invalidate all entries
 - invalidate entries by MVA, clean entries by MVA
 - invalidate entries by set/way, clean entries by set/way

———— **Note** —————

In ARMv7:

- cache operations are defined as affecting the caches when the caches are disabled.
- address based cache maintenance operations are defined as affecting all memory types.

Before ARMv7 these features of the cache operations are IMPLEMENTATION DEFINED.

ARMv6 defines a number of optional cache range operations. The defined range operations are:

- for an instruction cache:
 - invalidate range by VA
- for a data cache:
 - invalidate range by VA
 - clean range by VA
 - clean and invalidate range by VA
- prefetch related operations:
 - prefetch instruction range by VA
 - prefetch data range by VA
 - stop prefetch range.

For more information, see *Block transfer operations* on page AppxG-41.

CP15 also supports configuration and control of cache lockdown. For details of the CP15 cache operation and lockdown support in ARMv6, see:

- *c7, Cache operations* on page AppxG-38
- *c9, Cache lockdown support* on page AppxG-45.

Cache behavior at reset

In ARMv6, all cache lines in a cache, and all cached entries associated with branch prediction support, are invalidated by a reset. This is different to the ARMv7 behavior described in *Behavior of the caches at reset* on page B2-6.

G.6.3 Tightly Coupled Memory (TCM) support

Tightly Coupled Memory (TCM) support on page AppxG-9 introduced TCMs and their use at the application level. In addition, TCMs can be used to hold critical system-level routines such as interrupt handlers, and critical data structures such as interrupt stacks. Using TCMs can avoid indeterminate cache accesses.

ARMv6 supports up to four banks of data TCM and up to four banks of instruction TCM. You must program each bank to be in a different location in the physical memory map.

ARMv6 expects TCM to be used as part of the physical memory map of the system, and not to be backed by a level of external memory with the same physical addresses. For this reason, TCM behaves differently from a cache for regions of memory that are marked as being Write-Through Cacheable. In such regions, a write to a memory locations in the TCM never causes an external write.

A particular memory location must be contained either in the TCM or in the cache, and cannot be in both. In particular, no coherency mechanisms are supported between the TCM and the cache. This means that it is important when allocating the TCM base addresses to ensure that the same address ranges are not contained in the cache.

TCM support and VMSA

TCMs are supported in ARMv6 with VMSA support. However, there are some usage restrictions.

Restriction on translation table mappings

In a VMSA implementation, the TCM must appear to be implemented as Physically-Indexed, Physically-Addressed memory. This means it must behave as follows:

- Entries in the TCM do not have to be cleaned or invalidated by software for different virtual to physical address mappings.
- Aliases to the same physical address can exist in memory regions that are held in the TCM. This means the translation table mapping restrictions for TCM are less restrictive than for cache memory. See *Virtual to physical translation mapping restrictions* on page AppxG-26 for cache memory restrictions.

Restriction on translation table attributes

In a VMSA implementation, the translation table entries that describe areas of memory that are handled by the TCM can be Cacheable or Non-cacheable, but must not be marked as Shareable. If they are marked as either Device or Strongly-ordered, or have the Shareable attribute set, the locations that are contained in the TCM are treated as being Non-shareable, Non-cacheable.

TCM CP15 configuration and control

In ARMv7, a TCM Type Register is required. However, its format can be compatible with ARMv6 or IMPLEMENTATION DEFINED. For more information, see *c0, TCM Type Register (TCMTR)* on page B3-85.

In ARMv6, CP15 c0 and c9 registers configure and control the TCMs in a system. For more information, see:

- *c0, TCM Type Register (TCMTR)* on page AppxG-33
- *c9, TCM support* on page AppxG-46.

Note

In addition to the basic TCM support model in ARMv6, a set of range operations that can operate on caches and TCMs are documented. Range operations are considered optional in ARMv6. See *Block transfer operations* on page AppxG-41.

The ARM Architecture Reference Manual (DDI 0100) described an ARMv6 feature known as SmartCache, and a level 1 DMA model associated with TCM support. Both of these features are considered as IMPLEMENTATION DEFINED, and are not described in this manual.

In some implementations of ARMv4 and ARMv5, bits in the CP15 System Control Register, SCTLR[19:16] or a subset, are used for TCM control. From ARMv6 these bits have fixed values, and no SCTLR bits are used for TCM control.

G.6.4 Virtual memory support

A key component of the Virtual Memory System Architecture (VMSA) is the use of translation tables. ARMv6 supports two formats of virtual memory translation table:

- a legacy format for ARMv4 and ARMv5 compatibility
- a revised format, called the VMSAv6 format, that is also used in ARMv7.

Both table formats support use of the *Fast Context Switch Extension (FCSE)*, but ARM deprecates use of the FCSE, and the FCSE is optional in ARMv7. For the differences in VMSAv6 format support between ARMv6 and ARMv6K, see *VMSAv6 translation table format* on page AppxG-26.

Note

- ARMv7 does not support the legacy format.
 - ARMv7 VMSA support is the same as that supported by the revised format in ARMv6K, except for the address mapping restrictions described:
 - for ARMv6 in *Virtual to physical translation mapping restrictions* on page AppxG-26
 - for ARMv7 in *Address mapping restrictions* on page B3-23.
 - For more information about the FCSE see Appendix E *Fast Context Switch Extension (FCSE)*.
-

Execute Never (XN)

The ARMv7 requirement that instruction prefetches are not made from read-sensitive devices also applies to earlier versions of the architecture:

- ARMv7 requires you to mark all read-sensitive devices with the Execute-never (XN) to ensure that this requirement is met, see *The Execute Never (XN) attribute and instruction prefetching* on page B3-30
- before ARMv7, how this requirement is met is IMPLEMENTATION DEFINED.

Legacy translation table format

ARMv6 legacy support only includes the coarse translation table type as described in *Second level Coarse page table descriptor format* on page AppxH-25. ARMv6 does not support the fine level 2 Page table format. Therefore the legacy translation table format includes subpage access permissions but does not support 1KB Tiny pages. Table G-4 shows the legacy first level translation table entry formats.

Table G-4 Legacy first level descriptor format

	31		20 19		14	12 11 10 9 8		5 4 3 2 1 0		
Fault	IGN								0 0	
Coarse page table	Coarse page table base address					IMP	Domain	SBZ		0 1
Section	Section base address		SBZ	TEX	AP	IMP	Domain	SBZ	CB	1 0
	Reserved								1 1	

Note

ARMv5TE includes optional support for Supersections, Shareable memory, and the TEX bitfield. See *Virtual memory support* on page AppxH-21.

Use of the SCTL.R.S and SCTL.R.R bits described in Table H-6 on page AppxH-23 is deprecated. They are implemented for use only with the legacy format translation tables, and their use is not supported in VMSAv6 or VMSAv7.

VMSAv6 translation table format

The VMSAv6 translation table format is fully compatible with the virtual memory support in ARMv7-A. It includes the following features:

- the ability to mark a virtual address as either global or context-specific
- the ability to encode the Normal, Device, or Strongly-ordered memory type into the translation tables
- the Shareable attribute
- the XN execute never access permission attribute
- a third AP bit
- a TEX bitfield used with the C and B bits to define the cache attributes for each page of memory
- support for an application-specific (ASID) or global identifier
- 16MB Supersections, and the ability to map a Supersection to a 16MB range.

Related to this new translation table format, VMSAv6 provides:

- support for two translation table base registers and an associated control register
- independent fault status and fault address registers for reporting Prefetch Abort exceptions and Data Abort exceptions
- a Context ID Register, CONTEXTIDR.

ARMv6K added the following features to VMSAv6:

- An additional access permission encoding, AP[2:0] == 0b111, and an associated simplified access permissions model. See *Access permissions* on page B3-28, and *Simplified access permissions model* on page B3-29.
- The access flag feature. See *The access flag* on page B3-21.
- TEX remapping. See *Memory region attribute descriptions when TEX remap is enabled* on page B3-34.

Virtual to physical translation mapping restrictions

An ARMv6 implementation can restrict the mapping of pages that remap virtual address bits [13:12]. This restriction, called page coloring, supports the handling of aliases by an implementation that uses VIPT caches. On an implementation that imposes this restriction, the most significant bit of the cache size fields for the instruction and data caches in the CTR is Read-As-One, see *c0, Cache Type Register (CTR)* on page AppxH-35.

To avoid alias problems, this restriction enables these bits of the virtual address to be used to index into the cache without requiring hardware support. The restriction supports virtual indexing on caches where a cache way has a maximum size of 16KB. There is no restriction on the number of ways supported. Cache ways of

4KB or less do not suffer from this restriction, because any address (virtual or physical) can only be assigned to a single cache set. Where NSETS is the number of sets, and LINELEN is the cache line length, the ARMv6 cache policy associated with virtual indexing is:

$\log_2(\text{NSETS} \times \text{LINELEN}) \leq 12$; no VI restriction
 $12 < \log_2(\text{NSETS} \times \text{LINELEN}) \leq 14$; VI restrictions apply
 $\log_2(\text{NSETS} \times \text{LINELEN}) > 14$; PI only, VI not supported

If a page is marked as Non-shareable, then if the most significant bits of the cache size fields are RAO, the implementation requires the remapping restriction and the following restrictions apply:

- If multiple virtual addresses are mapped onto the same physical addresses, then for all mappings bits [13:12] of the virtual address must be equal, and must also be equal to bits [13:12] of the physical address. The same physical address can be mapped by TLB entries of different page sizes. These can be 4KB, 64KB, or sections.
- If all mappings to a physical address are of a page size equal to 4KB, the restriction that bits [13:12] of the virtual address must equal bits [13:12] of the physical address is not required. Bits [13:12] of all virtual address aliases must still be equal.

There is no restriction on the more significant bits in the virtual address.

If a page is marked as Shareable and Cacheable, memory coherency must be maintained across the shareability domain. In ARMv7, software manages instruction coherency, and data caches must be transparent. See *Shareable, Inner Shareable, and Outer Shareable Normal memory* on page A3-30 for more information.

———— **Note** —————

In some implementations, marking areas of memory as Shareable can have substantial performance effects, because those areas might not be held in caches.

ARMv6 and the Security Extensions

The Security Extensions provide virtual memory support for two physical address spaces as described in *Secure and Non-secure address spaces* on page B3-26 and are supported from ARMv6K. Support is the same as in ARMv7 with the following exceptions:

- ARMv6 only supports CP15 operations for virtual to physical address translation as part of the Security Extensions. ARMv7 includes support in the base architecture. For details see *Virtual Address to Physical Address translation operations* on page B3-63.
- Additional bits are allocated in the NSACR register. See *c1, VMSA Security Extensions support* on page AppxG-35.
- When implemented, the Cache Dirty Status Register is a Banked register. See *c7, Cache Dirty Status Register (CDSR)* on page AppxG-39.
- A Cache Behavior Override Register is defined. See *c9, Cache Behavior Override Register (CBOR)* on page AppxG-49.

- TCM access support registers are defined. See *c9, TCM Non-Secure Access Control Registers, DTCM-NSACR and ITCM-NSACR* on page AppxG-51.

CP15 support for the Security Extensions in ARMv7 is defined in *Effect of the Security Extensions on the CP15 registers* on page B3-71.

CP15SDISABLE input

The effect of this input is described for ARMv7 in *The CP15SDISABLE input* on page B3-76. In ARMv6K, TCM support is affected as follows:

- the DTCM_NSAC and ITM_NSAC registers are added to the controlled register list
- any TCM region registers restricted to Secure access only by the NSACR register settings are added to the controlled register list.

G.6.5 Protected Memory System Architecture (PMSA)

PMSA in ARMv5 is IMPLEMENTATION DEFINED. The method described in *Protected memory support* on page AppxH-28 is only supported in ARMv4 and ARMv5. PMSA is formalized in ARMv6 under a different CP15 support model.

The PMSA support in ARMv6 (PMSAv6) differs from PMSAv7 in the following ways:

- PMSAv6 does not support subregions as defined in *Subregions* on page B4-3.
- The default memory map shown in Table B4-1 on page B4-6 and Table B4-2 on page B4-7 does not support the XN bit for restricting instruction fetches. The affected addresses are treated as Normal, Non-cacheable in PMSAv6.
- The default memory map applies only when the MPU is disabled. The SCTL.R.BR bit is not supported in PMSAv6.
- TCM memory behaves as normal when the TCM region is enabled and the MPU is disabled.

In all other respects, PMSAv6 is as described for ARMv7 in Chapter B4 *Protected Memory System Architecture (PMSA)*.

Execute Never (XN)

The ARMv7 requirement that instruction prefetches are not made from read-sensitive devices also applies to earlier versions of the architecture:

- ARMv7 requires you to mark all read-sensitive devices with the Execute-never (XN) to ensure that this requirement is met, see *The Execute Never (XN) attribute and instruction prefetching* on page B3-30
- before ARMv7, how this requirement is met is IMPLEMENTATION DEFINED.

G.7 System Control coprocessor (CP15) support

Much of the CP15 support is common to VMSAv6 and PMSAv6. However:

- some registers are unique to each memory system architecture
- some registers have different functionality in the two memory system architectures, for example the SCTLr.

The following sections summarize the ARMv6 implementations of the CP15 registers:

- *Organization of CP15 registers for an ARMv6 VMSA implementation*
- *Organization of CP15 registers for an ARMv6 PMSA implementation* on page AppxG-31.

The rest of this section describes the ARMv6 CP15 support in order of the CRn value. The description of each register:

- indicates if the register is unique to VMSA or PMSA
- indicates any differences between the two implementations if the register is included in both VMSA and PMSA implementations.

Note

This approach is different from that taken in Part B of this manual, where:

- *CP15 registers for a VMSA implementation* on page B3-64 is a complete description of CP15 support in a VMSAv7 implementation
 - *CP15 registers for a PMSA implementation* on page B4-22 is a complete description of CP15 support in a PMSAv7 implementation.
-

The convention used for fixed bitfields in the CP15 register definitions is defined in *Meaning of fixed bit values in register diagrams* on page B3-78.

In ARMv6 the execution of an MCR or MRC instruction with an unallocated CP15 register encoding is UNPREDICTABLE.

ARMv6 provides some MCRR instructions to support block transfers, see *Block transfer operations* on page AppxG-41.

G.7.1 Organization of CP15 registers for an ARMv6 VMSA implementation

Figure G-1 on page AppxG-30 shows the CP15 registers in an ARMv6 VMSA implementation:

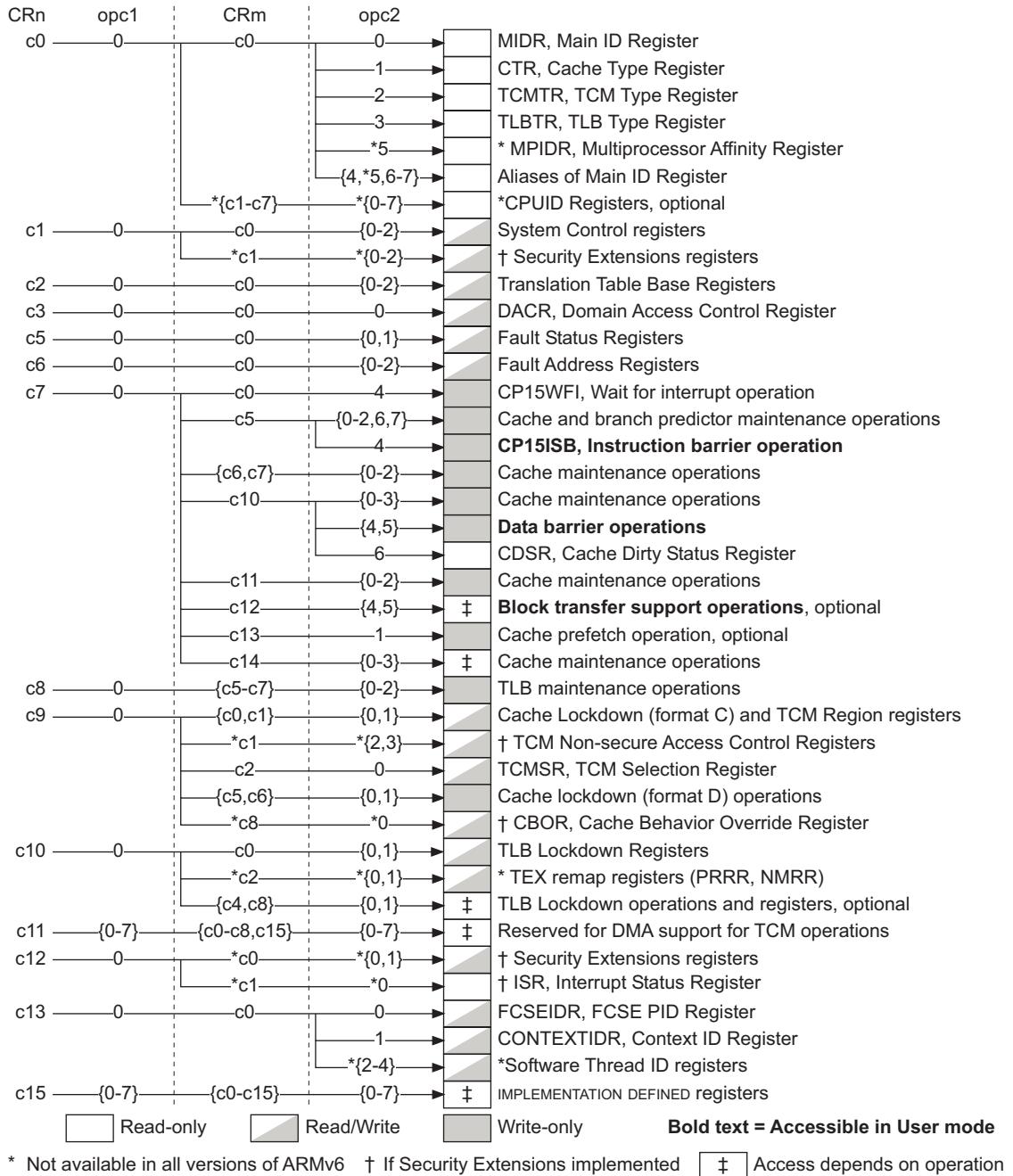

Figure G-1 CP15 registers in an ARMv6 VMSA implementation

G.7.2 Organization of CP15 registers for an ARMv6 PMSA implementation

Figure G-2 shows the CP15 registers in an ARMv6 PMSA implementation:

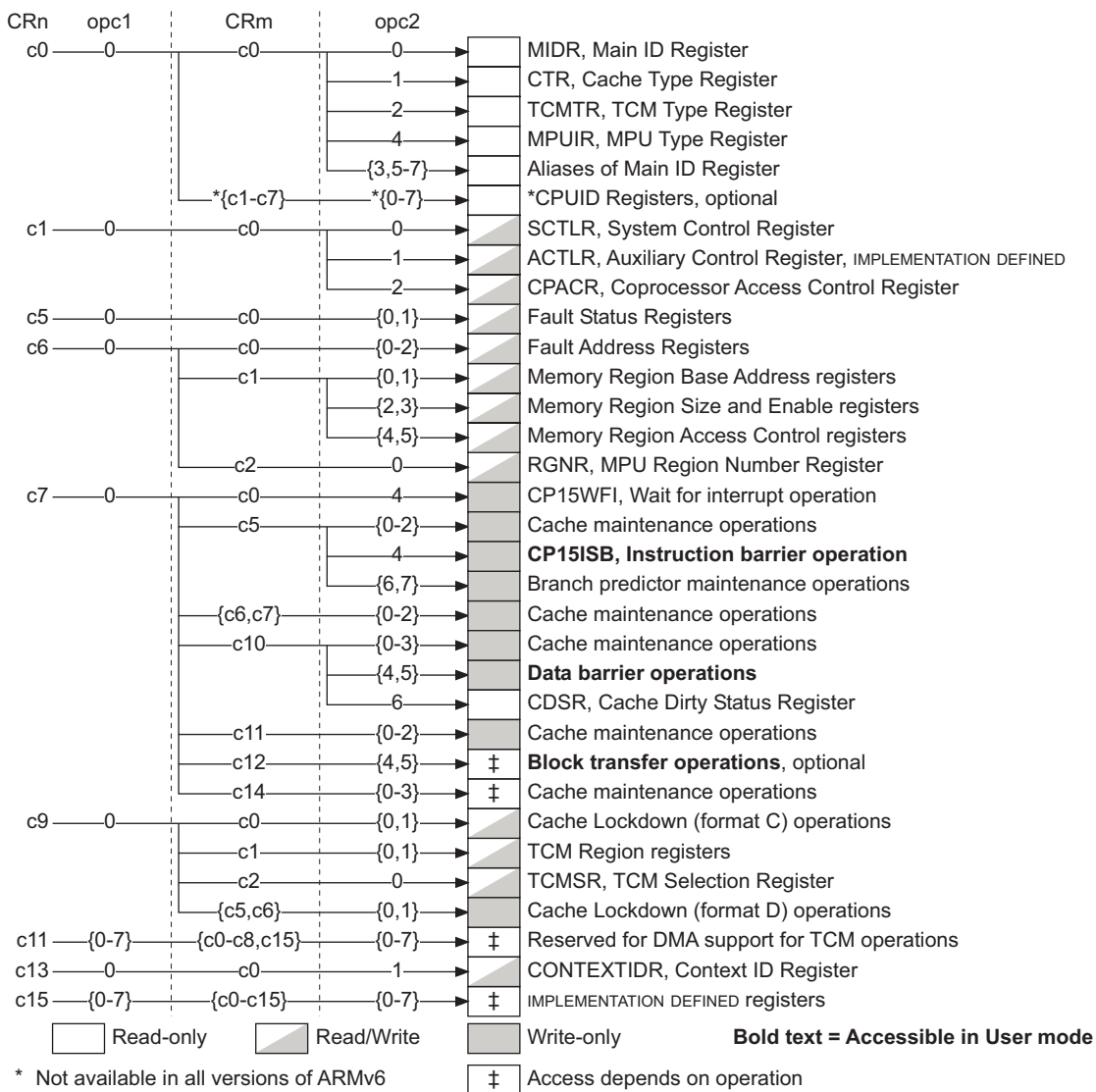

Figure G-2 CP15 registers in an ARMv6 PMSA implementation

G.7.3 c0, ID support

ARMv6 implementations include a Main ID Register, see *c0, Main ID Register (MIDR)* on page B3-81. In this register, the architecture variant field either takes the assigned ARMv6 value or indicates support for an identification scheme based on a set of CPUID registers. The CPUID identification scheme is required in ARMv7 and recommended for ARMv6, and is described in Chapter B5 *The CPUID Identification Scheme*.

Three other ID registers provide information about cache, TCM, and TLB provisions. From ARMv6K, there is also a Multiprocessor Affinity Register.

All of the CP15 c0 ID registers are read-only registers. They are accessed using MRC instructions, as shown in Table G-5.

Table G-5 ID register support

Register	CRn	opc1	CRm	opc2
MIDR, Main ID Register	c0	0	c0	0
CTR, Cache Type ID Register	c0	0	c0	1
TCMTR, TCM Type Register	c0	0	c0	2
TLBTR, TLB Type Register ^a	c0	0	c0	3
MPUIR, MPU Type Register ^c	c0	0	c0	4
MPIDR, Multiprocessor Affinity Register ^b	c0	0	c0	5
Aliases of MIDR	c0	0	c0	3 ^c , 4 ^a , 5 ^d , 6, 7
CPUID registers, if implemented	c0	0	c1	0-7
	c0	0	c2	0-5

a. VMSA processors only.

b. ARMv6K processors with VMSA only.

c. PMSA processors only.

d. All ARMv6 processors except ARMv6K VMSA implementations.

The Cache Type Register is as defined for ARMv4 and ARMv5, see *c0, Cache Type Register (CTR)* on page AppxH-35. In ARMv6, the CType values of 0b0110, and 0b0111 are reserved and must not be used.

Note

The ARMv6 format of the Cache Type Register is significantly different from the ARMv7 implementation described in *c0, Cache Type Register (CTR)* on page B3-83. However, the general properties described by the register, and the access rights for the register, are unchanged.

The TCM Type Register is defined in *c0, TCM Type Register (TCMTR)* on page AppxG-33.

The TLB Type ID Register and the Multiprocessor Affinity Register are as defined for ARMv7, see:

- *c0*, *TLB Type ID Register (TLBTR)*
- *c0*, *Multiprocessor Affinity Register (MPIDR)* on page B3-87.

The MPU Type Register is as defined for ARMv7, see *c0*, *MPU Type Register (MPUIR)* on page B4-36. In an ARMv6 PMSA implementation, if the MPU is not implemented use of the default memory map is optional.

c0, TCM Type Register (TCMTR)

The TCMTR must be implemented in ARMv6 and ARMv7. In ARMv7, the register can have a different format from that given here, see *c0*, *TCM Type Register (TCMTR)* on page B3-85.

In ARMv7, TCM support is IMPLEMENTATION DEFINED. For ARMv6, see *c9*, *TCM support* on page AppxG-46 and *c9*, *TCM Non-Secure Access Control Registers, DTCM-NSACR and ITCM-NSACR* on page AppxG-51 where the Security Extensions are supported.

31	29	28	19	18	16	15	3	2	0
0	0	0	Reserved			DTCM	Reserved		ITCM

Bits [31:29] Set to 0b000 before ARMv7.

Bits [28:19,15:3]

Reserved.

DTCM, Bits [18:16] Indicate the number of Data TCMs implemented. This value lies in the range 0 to 4, 0b000 to 0b100. All other values are reserved.

ITCM, Bits [2:0] Indicate the number of Instruction or Unified TCMs implemented. This value lies in the range 0 to 4, 0b000 to 0b100. All other values are reserved.

Instruction TCMs are accessible to both instruction and data sides.

c0, TLB Type ID Register (TLBTR)

In an ARMv6 VMSA implementation the TLB Type Register, TLBTR, is a read-only register that defines whether the implementation provides separate instruction and data TLBs, or a unified TLB. It also defines the number of lockable TLB entries. The ARMv7-A description of the register describes the general features of the register and how to access it. See *c0*, *TLB Type Register (TLBTR)* on page B3-86. However, the register format is different in ARMv6. The ARMv6 format of the TLBTR is:

31	24	23	16	15	8	7	1	0	
Reserved			I_nlock		D_nlock		Reserved		nU

Bits [31:24, 7:1] Reserved, UNK.

I_nlock, bits [23:16] Number of lockable entries in the instruction TLB. The value of this field gives the number of lockable entries, between 0b00000000 for no lockable entries, and 0b11111111 for 255 lockable entries.

When nU == 0 this field is reserved, UNK.

D_nlock, bits [15:8] Number of lockable entries in the data TLB. The value of this field gives the number of lockable entries, between 0b00000000 for no lockable entries, and 0b11111111 for 255 lockable entries.

nU, bit [0] Not Unified TLB. Indicates whether the implementation has a unified TLB:

nU == 0 Unified TLB.

nU == 1 Separate instruction and data TLBs.

G.7.4 c1, System control support

ARMv6 implements the same system control registers as ARMv7:

- for a VMSA implementation, see *CP15 c1, System control registers* on page B3-96
- for a PMSA implementation, see *CP15 c1, System control registers* on page B4-44.

c1, System Control Register (SCTLR)

This register is the primary system configuration register in CP15. It is defined differently for VMSA and PMSA.

In a VMSAv6 implementation, the format of the SCTLR is:

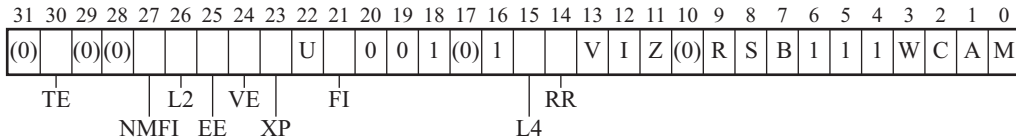

In an ARMv6K VMSA implementation, the format of the SCTLR is:

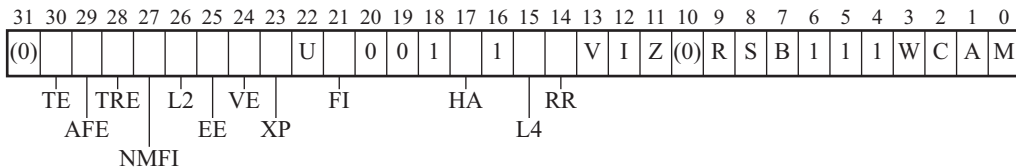

———— **Note** —————

Where the Security Extensions are implemented, some SCTLR bits are banked as described in *c1, System Control Register (SCTLR)* on page B3-96.

In a PMSAv6 implementation, the format of the SCTLR is:

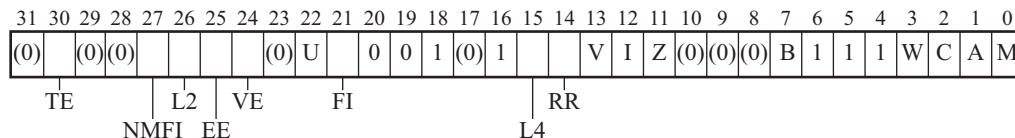

The differences from ARMv7 are:

- ARMv6 does not support the SCTLR.IE and SCTLR.BR, bits 31 and 17.
- ARMv7 does not support:
 - The L2, L4, R, S, B, and W bits. These bits provide legacy support with ARMv4 and ARMv5. See *c1, System Control Register (SCTLR)* on page AppxH-39 for their definition. The B bit must also meet the requirements defined in *Endian support* on page AppxG-7.
 - The U bit. This bit is always 1 in ARMv7. It selects the ARMv4 and ARMv5 or the ARMv6 and ARMv7 alignment model. For details see *Alignment* on page AppxG-6.
 - The XP bit. This bit is always 1 in ARMv7. The bit selects the virtual memory support model of ARMv6 and ARMv7 when SCTLR.XP = 1, and the legacy support for ARMv4 and ARMv5 when SCTLRR.XP = 0. For ARMv6 and ARMv7 support, see *VMSAv6 translation table format* on page AppxG-26 and Chapter B3 *Virtual Memory System Architecture (VMSA)*, and for ARMv4 and ARMv5 support, see *Legacy translation table format* on page AppxG-25 and *Virtual memory support* on page AppxH-21.
- The TE bit is defined for ARMv6T2 only. In ARMv6T2 it is the same as in ARMv7.

For the definition of bits supported in ARMv6 and ARMv7, see:

- *c1, System Control Register (SCTLR)* on page B3-96 for a VMSA implementation
- *c1, System Control Register (SCTLR)* on page B4-45 for a PMSA implementation.

G.7.5 c1, VMSA Security Extensions support

An ARMv6 implementation that includes the Security Extensions provides:

- the banking of bits in SCTLR, see *c1, System Control Register (SCTLR)* on page AppxG-34
- features that are include in an ARMv7 implementation of the Security Extensions, see:
 - *c1, Secure Configuration Register (SCR)* on page B3-106
 - *c1, Secure Debug Enable Register (SDER)* on page B3-108
 - *c1, Non-Secure Access Control Register (NSACR)* on page B3-110

In addition, ARMv6 defines the following additional bits in the NSACR:

Bit [18], DMA DMA control register access for support in CP15 c11 in the Non-secure address space. For more information, see *c11, DMA support* on page AppxG-54.

Bit [17], TL TLB Lockdown Register access for support in CP15 c10 in the Non-secure address space. For information on TLB lockdown support in ARMv6 see *c10, VMSA TLB lockdown support* on page AppxG-53.

Bit [16], CL Cache Lockdown Register access for support in CP15 c9 in the Non-secure address space. For information on cache lockdown support in ARMv6 see *c9, Cache lockdown support* on page AppxG-45.

In all cases:

- a value of 0 in the bit position specifies that the associated registers cannot be accessed in the Non-secure address space
- a value of 1 in the bit position specifies that the associated registers can be accessed in the Secure and Non-secure address spaces.

Support of these additional bits and more details on how DMA support for TCMs, TLB lockdown, and cache lockdown are inhibited in the Non-secure address space is IMPLEMENTATION DEFINED.

G.7.6 c2 and c3, VMSA memory protection and control registers

ARMv6 and ARMv7 provide the same CP15 support:

- two Translation Table Base Registers, TTBR0 and TTBR1
- a Translation Table Base Control Register, TTBCR
- a Domain Access Control Register, DACR.

The translation table registers are defined in *CP15 c2, Translation table support registers* on page B3-113.

The *Domain Access Control Register* (DACR) is as defined in *c3, Domain Access Control Register (DACR)* on page B3-119.

———— Note —————

When the Security Extensions are implemented, these registers are Banked registers.

G.7.7 c5 and c6, VMSA memory system support

The support in ARMv6 is the same as ARMv7 with the following exceptions:

- Bit 12 of the data and instruction fault status registers is not defined in ARMv6. See *c5, Data Fault Status Register (DFSR)* on page B3-121 and *c5, Instruction Fault Status Register (IFSR)* on page B3-122.
- The *Auxiliary Data Fault Status Register* (ADFSR) and the *Auxiliary Instruction Fault Status Register* (AIFSR) are not defined in ARMv6. See *c5, Auxiliary Data and Instruction Fault Status Registers (ADFSR and AIFSR)* on page B3-123.
- The Access Flag faults shown in Table B3-11 on page B3-50 and Table B3-12 on page B3-51 are only supported in ARMv6K.

Note

- Before ARMv7, the DFAR was called the *Fault Address Register (FAR)*.
 - If the Security Extensions are implemented, these registers are Banked registers.
 - In ARMv6 variants other than ARMv6T2, the IFAR is optional.
-

G.7.8 c5 and c6, PMSA memory system support

The support in ARMv6 is the same as ARMv7 with the following exceptions:

- The SCTL.R.BR bit, bit [17], is not supported in ARMv6, see *c1, System Control Register (SCTLR)* on page B4-45.
- Bit 12 of the data and instruction fault status registers is not defined in ARMv6. See *c5, Data Fault Status Register (DFSR)* on page B4-55 and *c5, Instruction Fault Status Register (IFSR)* on page B4-56.
- The ADFSR and the AIFSR are not defined in ARMv6. See *c5, Auxiliary Data and Instruction Fault Status Registers (ADFSR and AIFSR)* on page B4-56.
- Subregions are not supported. This means that DR.SR[15:8] and IR.SR[15:8] are not defined in ARMv6. See *c6, Data Region Size and Enable Register (DRSR)* on page B4-62 and *c6, Instruction Region Size and Enable Register (IRSR)* on page B4-63.

Note

- Before ARMv7, the DFAR was called the *Fault Address Register (FAR)*.
 - In ARMv6 variants other than ARMv6T2, the IFAR is optional.
-

G.7.9 c6, Watchpoint Fault Address Register (DBGWFAR)

From v6.1 of the Debug architecture, this register is also implemented as DBGWFAR in CP14, and the use of CP15 DBGWFAR is deprecated.

In an ARMv6 implementation that includes the Security Extensions, CP15 DBGWFAR is a Secure register, and can be accessed only from Secure privileged modes. For more information, see *Restricted access CP15 registers* on page B3-73.

For more information about this register see *Effects of debug exceptions on CP15 registers and the DBGWFAR* on page C4-4 and *Effect of entering Debug state on CP15 registers and the DBGWFAR* on page C5-4.

Table G-6 Debug fault address support

Register	CRn	opc1	CRm	opc2
Watchpoint Fault Address Register, DBGWFAR	c6	0	c0	1

G.7.10 c7, Cache operations

Table G-7 shows the cache operations defined for ARMv6. They are performed as MCR instructions and only operate on a level 1 cache associated with a specific processor. The equivalent operations in ARMv7 operate on multiple levels of cache. See *CP15 c7, Cache maintenance and other functions* on page B3-126. For a list of required operations in ARMv6, see *Cache support* on page AppxG-21. Support of additional operations is IMPLEMENTATION DEFINED.

Table G-7 Cache operation support

Operation	CRn	opc1	CRm	opc2
Invalidate instruction cache ^a	c7	0	c5	0
Invalidate instruction cache line by MVA ^a	c7	0	c5	1
Invalidate instruction cache line by set/way	c7	0	c5	2
Flush entire branch predictor array ^a	c7	0	c5	6
Flush branch predictor array entry by MVA ^a	c7	0	c5	7
Invalidate data cache	c7	0	c6	0
Invalidate data cache line by MVA ^a	c7	0	c6	1
Invalidate data cache line by set/way ^a	c7	0	c6	2
Invalidate unified cache, or instruction cache and data cache	c7	0	c7	0
Invalidate unified cache line by MVA	c7	0	c7	1
Invalidate unified cache line by set/way	c7	0	c7	2
Clean data cache	c7	0	c10	0
Clean data cache line by MVA ^a	c7	0	c10	1
Clean data cache line by set/way ^a	c7	0	c10	2
Test and Clean data cache ^b	c7	0	c10	3
Cache Dirty Status Register ^c	c7	0	c10	6
Clean entire unified cache	c7	0	c11	0
Clean unified cache line by MVA ^a	c7	0	c11	1
Clean unified cache line by set/way	c7	0	c11	2
Prefetch instruction cache line by MVA ^d	c7	0	c13	1

Table G-7 Cache operation support (continued)

Operation	CRn	opc1	CRm	opc2
Clean and Invalidate data cache	c7	0	c14	0
Clean and Invalidate data cache line by MVA ^a	c7	0	c14	1
Clean and Invalidate data cache line by set/way ^a	c7	0	c14	2
Test and Clean and Invalidate data cache ^b	c7	0	c14	3
Clean and Invalidate unified cache line by MVA	c7	0	c15	1
Clean and Invalidate unified cache line by set/way	c7	0	c15	2

- a. These are the only cache operations available in ARMv7. The corresponding ARMv7 operations are multi-level operations, and the data cache operations are defined as data or unified cache operations.
- b. For more information about these cache operations see *Test and clean operations* on page AppxH-50.
- c. Used with the Clean or Clean and Invalidate entire data cache and entire unified cache operations.
- d. VMSA implementations only, used with TLB lockdown. See *The TLB lock by entry model* on page AppxH-60.

c7, Cache Dirty Status Register (CDSR)

The Cache Dirty Status Register, CDSR, indicates whether the data or unified cache has been written to since the last successful cache clean. For more information, see *Cleaning and invalidating operations for the entire data cache* on page AppxG-40.

The Cache Dirty Status Register is:

- a 32-bit read-only register
- accessible only in privileged modes
- when the Security Extensions are implemented, a Banked register.

The format of the Cache Dirty Status Register is:

31	1	0
Reserved		C

Bits [31:1] Reserved, UNK/SBZP.

C, bit [0] Cache Dirty Status. The meaning of this bit is:

- | | |
|----------|---|
| 0 | Cache clean. No write has hit the cache since the last cache clean or reset successfully cleaned the cache. |
| 1 | The cache might contain dirty data. |

Accessing the Cache Dirty Status Register

To access the Cache Dirty Status Register you read the CP15 registers with <opc1> set to 0, <CRn> set to c7, <CRm> set to c10, and <opc2> set to 6. For example:

```
MRC p15, 0, <Rt>, c7, c10, 6
```

Cleaning and invalidating operations for the entire data cache

The CP15 c7 encodings include operations for cleaning the entire data cache, and for performing a clean and invalidate of the entire data cache. If these operations are interrupted, the LR value that is captured on the interrupt is (address of instruction that launched the cache operation + 4). This permits the standard return mechanism for interrupts to restart the operation.

If a particular operation requires that the cache is clean, or clean and invalid, then it is essential that the sequence of instructions for cleaning or cleaning and invalidating the cache can cope with the arrival of an interrupt at any time when interrupts are not disabled. This is because interrupts might write to a previously cleaned cache block. For this reason, the Cache Dirty Status Register indicates whether the cache has been written to since the last successful cache clean.

You can interrogate the Cache Dirty Status Register to determine whether the cache is clean, and if you do this while interrupts are disabled, a subsequent operation can rely on having a clean cache. The following sequence illustrates this approach.

; The following code assumes interrupts are enabled at this point.

```
Loop1
    MOV    R1, #0
    MCR    p15, 0, R1, c7, c10, 0        ; Clean data cache. For Clean and Invalidate,
                                        ; use MCR p15, 0, R1, c7, c14, 0 instead
    MRS    R2, CPSR                      ; Save PSR context
    CPSID  iaf                          ; Disable interrupts
    MRC    p15, 0, R1, c7, c10, 6        ; Read Cache Dirty Status Register
    TST    R1, #1                        ; Check if it is clean
    BEQ    UseClean
    MSR    CPSR_xc, R2                   ; Re-enable interrupts
    B      Loop1                         ; Clean the cache again

UseClean
    Do_Clean_Operations                  ; Perform whatever operation relies on
                                        ; the cache being clean or clean & invalid.
                                        ; To reduce impact on interrupt latency,
                                        ; this sequence should be short.
    MCR    p15, 0, R1, c7, c6, 0        ; Optional. Can use this Invalidate all command
                                        ; to invalidate a Clean loop.
    MSR    CPSR_xc, R2                   ; Re-enable interrupts
```

Note

The long cache clean operation is performed with interrupts enabled throughout this routine.

Block transfer operations

ARMv7 does not support CP15 register block transfer operations, and they are optional in ARMv6. Table G-8 summarizes block transfer operations. Permitted combinations of the block transfer operations are:

- all four operations
- clean, clean and invalidate, and invalidate operations
- none of the operations.

If an operation is not implemented, then it must cause an Undefined Instruction exception.

Table G-8 Block transfer operations

Operation	Blocking ^a or non-blocking	Instruction or data	User or privileged	Exception Behavior
Prefetch range	Non-blocking	Instruction or data	User or privileged	None
Clean range	Blocking	Data only	User or privileged	Data Abort
Clean and Invalidate range	Blocking	Data only	Privileged	Data Abort
Invalidate range	Blocking	Instruction or data	Privileged	Data Abort

a. See *Blocking and non-blocking behavior* on page AppxG-42

An MCRR instruction starts each of the range operations. The data of the two registers specifies the Block start address and the Block end address. All block operations are performed on the cachelines that include the range of addresses between the Block start address and Block end address inclusive. If the Block start address is greater than the Block end address the effect is UNPREDICTABLE.

ARMv6 supports only one block transfer at a time. Attempting to start a second block transfer while a block transfer is in progress causes the first block transfer to be abandoned and starts the second block transfer. The Block Transfer Status Register indicates whether a block transfer is in progress. The register can be polled before starting a block transfer, to ensure any previous block transfer operation has completed.

All block transfers are interruptible. When blocking transfers are interrupted, the LR value that is captured is (address of instruction that launched the block operation + 4). This enables the standard return mechanism for interrupts to restart the operation.

For performance reasons, ARM recommends that implementations permit the following instructions to be executed while a non-blocking prefetch range instruction is being executed. In such an implementation, the LR value captured on an interrupt is determined by the instruction set state presented to the interrupt in the following instruction stream. However, implementations that treat a prefetch range instruction as a blocking operation must capture the LR value as described in the previous paragraph.

If the FCSE PID is changed while a prefetch range operation is running, it is UNPREDICTABLE at which point this change is seen by the prefetch range. For information about changing the FCSE PID see *c13, FCSE Process ID Register (FCSEIDR)* on page B3-152.

Blocking and non-blocking behavior

The cache block transfer operations for cleaning, invalidating, or clean and invalidating a range of addresses from the cache are blocking operations. Following instructions must not be executed until the block transfer operation has completed. The prefetch range operation is non-blocking and can permit following instructions to be executed before the operation is complete. If an exception occurs a non-blocking operation does not signal an exception to the processor. This enables implementations to retire following instructions while the non-blocking operation is executing, without the requirement to retain precise processor state.

The blocking operations generate a Data Abort exception on a Translation fault if a valid translation table entry cannot be fetched. The DFAR indicates the address that caused the fault, and the DFSR indicates the reason for the fault.

Any fault on a prefetch range operation results in the operation failing without signaling an error.

Register encodings

Table G-9 shows the block operations supported using CP15. The operations are performed using an MCRR instruction. See *MCRR*, *MCRR2* on page A8-188.

The instruction format for block operations is:

```
MCRR p15, <Opc>, <Rt>, <Rn>, <CRm>
```

Table G-9 Enhanced cache control operations using MCRR

CRm	Opc	Function	Rn Data, VA ^a	Rt Data, VA ^a
c5	0	Invalidate instruction cache range ^b	Start address	End address
c6	0	Invalidate data cache range ^b	Start address	End address
c12	0	Clean data cache range ^c	Start address	End address
c12	1	Prefetch instruction range ^c	Start address	End address
c12	2	Prefetch data range ^c	Start address	End address
c14	0	Clean and invalidate data cache range ^b	Start address	End address

- The true virtual address, before any modification by the FCSE. See Appendix E *Fast Context Switch Extension (FCSE)*. This address is translated by the FCSE logic.
- Accessible only in privileged modes. Results in an UNDEFINED instruction exception if the operation is attempted in user mode.
- Accessible in both unprivileged and privileged modes.

Note

The ARMv6 MCRR encodings that support block operations are UNDEFINED in ARMv7.

The range operations operate on cache lines. The first cache line operated on is the line that contains the start address. The operation is then applied to every cache line up to and including the line that contains the end address.

The format of the start address and end address data values passed by the MCRR instructions is:

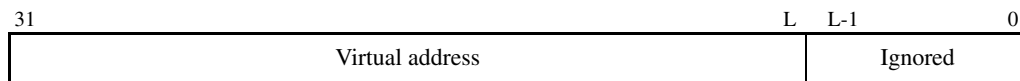

Start address **Virtual Address bits [31:L]**

The first virtual address of the block transfer.

End address **Virtual Address bits [31:L]**

The virtual address at which the block transfer stops. This address is at the start of the line containing the last address to be handled by the block transfer.

L is $\text{Log}_2(\text{LINELEN})$, where LINELEN is the cache line length parameter. Because the least significant address bits are ignored, the transfer automatically adjusts to a line length multiple spanning the programmed addresses.

———— **Note** ————

The block operations use virtual addresses, not modified virtual addresses. All other address-based cache operations use MVAs.

CP15 c7 operations for block transfer management

Two CP15 c7 operations support block transfer management. These operations must be implemented when the block transfer operations are implemented:

StopPrefetchRange MCR p15, 0, <Rt>, c7, c12, 5; Write-only, <Rt> Should-Be-Zero

PrefetchStatus MRC p15, 0, <Rt>, c7, c12, 4; Read Block Transfer Status Register

Both operations are accessible in unprivileged and privileged modes. Because all block operations are mutually exclusive, that is, only one operation can be active at any time, the PrefetchStatus operation returns the status of the last issued Prefetch request, instruction, or data. This status is held in the Block Transfer Status Register.

c7, Block Transfer Status Register

The Block Transfer Status Register indicates whether a block transfer is in progress.

The format of the Block Transfer Status Register is:

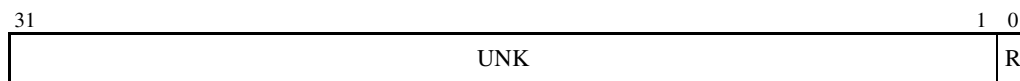

Bits [31:1] Reserved.

R, bit [0]	Block Prefetch Running
0	No prefetch in operation
1	Prefetch in operation.

G.7.11 c7, Miscellaneous functions

The Wait For Interrupt operation is used in some implementations as part of a power management support scheme. The operation is deprecated in ARMv6 and not supported in ARMv7, where it behaves as a NOP instruction.

Barrier operations are used for system correctness to ensure visibility of memory accesses to other agents in a system. Barrier functionality was formally defined as part of the memory architecture enhancements introduced in ARMv6. The definitions are the same as for ARMv7. For details see *Memory barriers* on page A3-47.

Table G-10 summarizes the MCR instruction encoding details.

Table G-10 memory barrier register support

Operation	CRn	opc1	CRm	opc2
<i>Wait For Interrupt</i> (CP15WFI)	c7	0	c0	4
<i>Instruction Synchronization Barrier</i> (CP15ISB) ^a	c7	0	c5	4
<i>Data Synchronization Barrier</i> (CP15DSB) ^b	c7	0	c10	4
<i>Data Memory Barrier</i> (CP15DMB)	c7	0	c10	5

a. This operation was previously known as *Prefetch Flush* (PF or PFF).

b. This operation was previously known as *Data Write Barrier* or *Drain Write Buffer* (DWB).

G.7.12 c7, VMSA virtual to physical address translation support

If the Security Extensions are implemented in ARMv6K, virtual to physical address translation support is provided as described in *CP15 c7, Virtual Address to Physical Address translation operations* on page B3-130.

G.7.13 c8, VMSA TLB support

CP15 TLB operation provision in ARMv6 is the same as for ARMv7-A. For details see *TLB maintenance* on page B3-56 and *CP15 c8, TLB maintenance operations* on page B3-138.

G.7.14 c9, Cache lockdown support

One problem with caches is that although they normally improve average access time to data and instructions, they usually increase the worst-case access time. This occurs for a number of reasons, including:

- There is a delay before the system determines that a cache miss has occurred and starts the main memory access.
- If a Write-Back cache is being used, there might be an extra delay because of the requirement to store the contents of the cache line that is being reallocated.
- A whole cache line is loaded from main memory, not only the data requested by the ARM processor.

In real-time applications, this increase in the worst-case access time can be significant.

Cache lockdown is an optional feature designed to alleviate this. It enables critical code and data, for example high priority interrupt routines and the data they access, to be loaded into the cache in such a way that the cache lines containing them are not subsequently reallocated. This ensures that all subsequent accesses to the code and data concerned are cache hits and therefore complete as quickly as possible.

From ARMv7, cache lockdown is IMPLEMENTATION DEFINED with no recommended formats or mechanisms on how it is achieved other than reserved CP15 register space. See *Cache lockdown* on page B2-8 and *CP15 c9, Cache and TCM lockdown registers and performance monitors* on page B3-141.

ARMv4 and ARMv5 specify four formats for the cache lockdown mechanism, known as Format A, Format B, Format C, and Format D. The Cache Type Register contains information on the lockdown mechanism adopted. See *c0, Cache Type Register (CTR)* on page AppxH-35. Formats A, B, and C all operate on cache ways. Format D is a cache entry locking mechanism.

ARMv6 cache lockdown support must comply with Format C or Format D. For more information, see *c9, cache lockdown support* on page AppxH-52.

———— Note —————

A Format D implementation must use the CP15 lockdown operations with the CRm == {c5,c6} encodings, and not the alternative encodings with CRm == {c1,c2}.

Interaction with CP15 c7 operations

Cache lockdown only prevents the normal replacement strategy used on cache misses from choosing to reallocate cache lines in the locked-down region. CP15 c7 operations that invalidate, clean, or clean and invalidate cache contents affect locked-down cache lines as normal. If invalidate operations are used, you must ensure that they do not use virtual addresses or cache set/way combinations that affect the locked-down cache lines. Otherwise, if it is difficult to avoid affecting the locked-down cache lines, repeat the cache lockdown procedure afterwards.

G.7.15 c9, TCM support

In ARMv7, CP15 c9 encodings with CRm == {c0-c2,c5-c8} are reserved for IMPLEMENTATION DEFINED branch predictor, cache, and TCM operations. In ARMv6, the TCM Type Register can determine the TCM support the processor provides. See c0, *TCM Type Register (TCMTR)* on page AppxG-33. Table G-11 summarizes the additional register support for TCMs in ARMv6.

Table G-11 TCM register support

Instruction	TCM Register
MRC MCR p15, 0, <Rt>, c9, c1, 0	Data TCM Region Register, DTCMRR
MRC MCR p15, 0, <Rt>, c9, c1, 1	Instruction or unified TCM Region Register, ITCMRR
MRC MCR p15, 0, <Rt>, c9, c2, 0	TCM Selection Register, TCMSR

Each implemented TCM has its own Region register that is banked onto either the Data TCM Region Register or the Instruction or unified TCM Region Register. The TCM Selection Register supplies the index for region register access.

Changing the TCM Region Register while a prefetch range or DMA operation is running has UNPREDICTABLE effects.

c9, TCM Selection Register (TCMSR)

The TCM Selection Register selects the current TCM Region Registers. Where separate data and instruction TCMs are implemented, the value in the TCM Selection Register defined the current region for accesses to both the Data TCM Region Register and the Instruction TCM Region Register, see Table G-11.

The TCM Selection Register is:

- a 32-bit read/write register
- accessible only in privileged modes
- when the Security Extensions are implemented, a Banked register.

The format of the TCM Selection Register is:

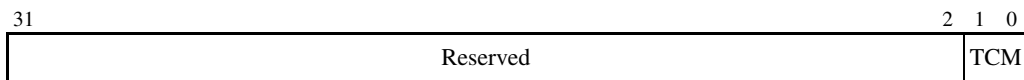

Bits [31:2] Reserved, UNK/SBZP.

TCM, bits [1:0]

TCM number, the index used to access a region register. TCM region registers can be accessed to read or change the details of the selected TCM.

This value resets to 0.

If this field is written with a value greater than or equal to the maximum number of implemented TCMs then the write is ignored.

c9, TCM Region Registers (DTCMRR and ITCMRR)

The TCM Region Registers provide control and configuration information for each TCM region.

Each TCM Region Register is:

- A 32-bit read/write register with some bits that are read-only.
- Accessible only in privileged modes.
- When the Security Extensions are implemented, a Configurable access register with Non-secure access controlled by the DTCM-NSACR. See *c9, TCM Non-Secure Access Control Registers, DTCM-NSACR and ITCM-NSACR* on page AppxG-51.
- Accessed by reading or writing the CP15 registers with <opc1> set to 0, <CRn> set to c9, <CRm> set to c1, and <opc2> set to:
 - 0 for the current Data TCM Region Register
 - 1 for the current Instruction or unified Region Register.

For example:

```
MRC p15,0,<Rt>,c9,c1,0 ; Read current Data TCM Region Register
MCR p15,0,<Rt>,c9,c1,0 ; Write current Data TCM Region Register
MRC p15,0,<Rt>,c9,c1,1 ; Read current Instruction or unified TCM Region Register
MCR p15,0,<Rt>,c9,c1,1 ; Write current Instruction or unified TCM Region Register
```

The format of the TCM region registers is:

31	12 11	7 6	2 1 0
BaseAddress	Reserved	Size	(0) En

BaseAddress, bits [31:12]

The base address of the TCM, given as the physical address of the TCM in the memory map. BaseAddress is assumed to be aligned to the size of the TCM. Any address bits in the range $[(\log_2(\text{RAMSize})-1):12]$ are ignored.

BaseAddress is 0 at reset.

Bits [11:7] Reserved

Size, bits [6:2]

Indicates the size of the TCM. See Table G-12 on page AppxG-48 for encoding of this field.

This field is read-only and ignores writes.

En, bit [0] TCM enable bit:

En == 0 Disabled. This is the reset value.

En == 1 Enabled.

Note

Bit [1] was defined as a *SmartCache* enable bit in the previous version of the ARM architecture. SmartCache is now considered to be IMPLEMENTATION DEFINED and not documented in this manual.

Table G-12 shows the encoding of the Size field in the TCM Region Registers:

Table G-12 TCM size field encoding

Size field	Memory size
0b00000	0KByte
0b00001, 0b00010	Reserved
0b00011	4KByte
0b00100	8KByte
0b00101	16KByte
0b00110	32KByte
0b00111	64KByte
0b01000	128KByte
0b01001	256KByte
0b01010	512KByte
0b01011	1MByte
0b01100	2MByte
0b01101	4MByte
0b01110	8MByte
0b01111	16MByte
0b10000	32MByte
0b10001	64MByte
0b10010	128MByte
0b10011	256MByte
0b10100	512MByte
0b10101	1GByte

Table G-12 TCM size field encoding (continued)

Size field	Memory size
0b10110	2GByte
0b10111	4GByte
0b11xxx	Reserved

An attempt to access a TCM region that is not implemented is UNPREDICTABLE. This can occur if the number of data and instruction TCMs supported is not the same.

The base address of each TCM must be different, and chosen so that no location in memory is contained in more than one TCM. If a location in memory is contained in more than one TCM, it is UNPREDICTABLE which memory location the instruction or data is returned from. Implementations must ensure that this situation cannot result in physical damage to the TCM.

G.7.16 c9, VMSA support for the Security Extensions

ARMv6K with VMSA support and the Security Extensions provides the following CP15 c9 support in addition to that defined for the Security Extensions in ARMv7-A:

- a Cache Behavior Override Register, CBOR
- where instruction TCM support is implemented, an ITCM Non-secure Access Control Register, ITCM_NSAC
- where data TCM support is implemented, a DTCM Non-secure Access Control Register, DTCM_NSAC.

c9, Cache Behavior Override Register (CBOR)

The Cache Behavior Override Register, CBOR, overrides some aspects of the normal cache behavior. Typically, these overrides are used for system debugging.

————— Note —————

Architecturally, the CBOR is defined only as part of the Security Extensions in ARMv6. It is IMPLEMENTATION DEFINED whether an ARMv7-A implementation includes the CBOR. An implementation that does not include the Security Extensions might implement the CBOR, but can implement only bits [2:0] of the register.

The CBOR is:

- a 32-bit read/write register
- accessible only in privileged modes

- when the Security Extensions are implemented, a Common register, with some bits that can be accessed only in Secure state.

The format of the CBOR is:

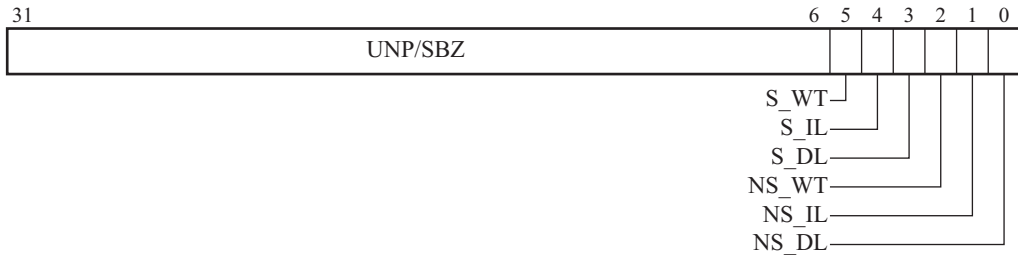

The CBOR resets to 0x00000000.

Register bits [5:3] are accessible only in Secure state. In Non-secure state they are RAZ/WI.

Bits [31:6] Reserved. UNK/SBZP.

S_WT, bit [5] Secure Write-Through. Controls whether Write-Through is forced for regions marked as Secure and Write-Back. The possible values of this bit are:

- 0** Do not force Write-Through. This corresponds to normal cache operation.
- 1** Force Write-Through for regions marked as Secure and Write-Back.

S_IL, bit [4] Secure instruction cache linefill. Can be used to disable instruction cache linefill for Secure regions. The possible values of this bit are:

- 0** Instruction cache linefill enabled. This corresponds to normal cache operation.
- 1** Instruction cache linefill disabled for regions marked as Secure.

S_DL, bit [3] Secure data cache linefill. Can be used to disable data cache linefill for Secure regions. The possible values of this bit are:

- 0** Data cache linefill enabled. This corresponds to normal cache operation.
- 1** Data cache linefill disabled for regions marked as Secure.

NS_WT, bit [2]

Non-secure Write-Through. Controls whether Write-Through is forced for regions marked as Non-secure and Write-Back. The possible values of this bit are:

- 0** Do not force Write-Through. This corresponds to normal cache operation.
- 1** Force Write-Through for regions marked as Non-secure and Write-Back.

NS_IL, bit [1] Non-secure instruction cache linefill. Can be used to disable instruction cache linefill for Non-secure regions. The possible values of this bit are:

- 0** Instruction cache linefill enabled. This corresponds to normal cache operation.
- 1** Instruction cache linefill disabled for regions marked as Non-secure.

NS_DL, bit [0]

Non-secure data cache linefill. Can be used to disable data cache linefill for Non-secure regions. The possible values of this bit are:

- 0** Data cache linefill enabled. This corresponds to normal cache operation.
- 1** Data cache linefill disabled for regions marked as Non-secure.

It might be necessary to ensure that cache contents are not changed, for example when debugging or when processing an interruptible cache operation. The CBOR provides this option.

For example, Clean All, and Clean and Invalidate All operations in Non-secure state might not prevent fast interrupts to the Secure side if the FW bit in the SCR is set to 0. In this case, operations in the Secure state can read or write Non-secure locations in the cache. Such operations might cause the cache to contain valid or dirty Non-secure entries after the Non-secure Clean All and Clean and Invalidate All operation has completed. To prevent this problem, the Secure state must be:

- prevented from allocating Non-secure entries into the cache by disabling Non-secure linefill
- made to treat all writes to Non-secure regions that hit in the cache as being write-through by forcing Non-secure Write-Through.

The CBOR provides separate controls for Secure and Non-secure memory regions, and can be used to prevent cache linefill, or to force Write-Through operation, while leaving the caches enabled. The controls for Secure memory regions can be accessed only when the processor is in the Secure state.

Accessing the CBOR

To access the CBOR you read or write the CP15 registers with <opc1> set to 0, <CRn> set to c9, <CRm> set to c8, and <opc2> set to 0. For example:

```
MRC p15, 0, <Rt>, c9, c8, 0 ; Read CP15 Cache Behavior Override Register
MCR p15, 0, <Rt>, c9, c8, 0 ; Write CP15 Cache Behavior Override Register
```

c9, TCM Non-Secure Access Control Registers, DTCM-NSACR and ITCM-NSACR

The *Data TCM Non-Secure Access Control Register* (DTCM-NSACR) defines the accessibility of the Data TCM Region Register when the processor is in Non-secure state.

The *Instruction TCM Non-Secure Access Control Register* (ITCM-NSACR) defines the accessibility of the current Instruction or Unified TCM Region Register when the processor is in Non-secure state.

For information on TCM support, see *Tightly Coupled Memory (TCM) support* on page AppxG-23.

The TCM-NSACR registers are:

- 32-bit read/write registers
- accessible only in privileged modes
- implemented only in a VMSAv6 implementation that includes the Security Extensions
- Secure registers, see *Restricted access CP15 registers* on page B3-73.

The format of a TCM-NSACR register is:



Bits [31:1] Reserved, UNK/SBZP.

NS_access, bit [0]

Non-secure access. Defines the accessibility of the corresponding current TCM Region Register from the Non-secure state. The possible values of this bit are:

- 0** The corresponding TCM Region Register is accessible only in Secure privileged modes.
The information stored in the corresponding TCM is Secure, and the TCM is visible only if the processor is in the Secure state and the translation table is marked as Secure.
- 1** The corresponding TCM Region Register is accessible in privileged modes in both Secure and Non-secure state.
The information stored in the corresponding TCM is Non-secure. The TCM is visible in the Non-secure state. It is visible in the Secure state only if the translation table is marked correctly as Non-secure.

The value of the TCM-NSACR.NS_access bit and the processor security state determine whether the TCM is visible. The value of the NS bit for the translation table entry determines what data is visible in the TCM. Table G-13 shows when the TCM is visible, and what data is visible.

Table G-13 Visibility of TCM and TCM data

Processor security state	TCM-NSACR NS_access bit	Translation table NS value	TCM visibility	Data visible
Secure	0	0	Visible	Secure
Secure	0	1	Not visible	-
Secure	1	0	Not visible	-
Secure	1	1	Visible	Non-secure
Non-secure	0	x	Not visible	-
Non-secure	1	x	Visible	Non-secure

Table G-14 shows when the TCM Region Register can be accessed, permitting control of the TCM.

Table G-14 Accessibility of TCM Region Register

Processor security state	TCM-NSACR NS_access bit	TCM Region Register access
Secure	x	In privileged modes only
Non-secure	0	No access
Non-secure	1	In privileged modes only

Accessing the TCM-NSACR registers

To access the TCM-NSACR registers you read or write the CP15 registers with <opc1> set to 0, <CRn> set to c9, <CRm> set to c1, and <opc2> set to:

- 2 to access the DTCM-NSACR register
- 3 to access the ITCM-NSACR register.

For example

```
MRC p15,0,<Rt>,c9,c1,2 ; Read CP15 Data TCM Non-secure Access Control Register
MCR p15,0,<Rt>,c9,c1,2 ; Write CP15 Data TCM Non-secure Access Control Register
MRC p15,0,<Rt>,c9,c1,3 ; Read CP15 Instruction TCM Non-secure Access Control Register
MCR p15,0,<Rt>,c9,c1,3 ; Write CP15 Instruction TCM Non-secure Access Control Register
```

G.7.17 c10, VMSA memory remapping support

ARMv7-A memory remapping is supported from ARMv6K with the addition of the SCTLR.TRE enable bit and two registers:

- the *c10, Primary Region Remap Register (PRRR)* on page B3-143
- the *c10, Normal Memory Remap Register (NMRR)* on page B3-146.

G.7.18 c10, VMSA TLB lockdown support

TLB lockdown is an optional feature that enables the results of specified translation table walks to be loaded into the TLB, in such a way that they are not overwritten by the results of subsequent translation table walks.

Translation table walks can take a long time, especially as they involve potentially slow main memory accesses. In real-time interrupt handlers, translation table walks caused by the TLB not containing translations for the handler or the data it accesses can increase interrupt latency significantly.

Two basic lockdown models are supported:

- a TLB lock by entry model
- a translate and lock model introduced as an alternative model in ARMv5TE.

From ARMv7-A, TLB lockdown is IMPLEMENTATION DEFINED with no recommended formats or mechanisms on how it is achieved other than reserved CP15 register space. See *TLB lockdown* on page B3-56 and *CP15 c10, Memory remapping and TLB control registers* on page B3-142.

For ARMv6, TLB lockdown must comply with one of the lockdown models described in *c10, VMSA TLB lockdown support* on page AppxH-59.

G.7.19 c11, DMA support

The ARMv6 DMA support for TCMs described in *The ARM Architecture Reference Manual* (DDI 0100) is considered IMPLEMENTATION DEFINED and not included in this manual. ARMv6 is therefore the same as ARMv7. See *CP15 c11, Reserved for TCM DMA registers* on page B3-147.

G.7.20 c12, VMSA support for the Security Extensions

CP15 c12 support for the Security Extensions in ARMv6 is the same as in ARMv7:

- the Vector Base Address Register, VBAR
- the Monitor Base Address Register, MVBAR
- the Interrupt Status Register, ISR.

For details see *CP15 c12, Security Extensions registers* on page B3-148.

G.7.21 c13, Context ID support

Both PMSAv6 and VMSAv6 require the CONTEXTIDR described in:

- *c13, Context ID Register (CONTEXTIDR)* on page B3-153, for a VMSA implementation
- *c13, Context ID Register (CONTEXTIDR)* on page B4-76, for a PMSA implementation.

In addition:

- A VMSAv6 implementation requires the FCSEIDR, described in *c13, FCSE Process ID Register (FCSEIDR)* on page B3-152. In ARMv6 the FCSE must be implemented. For more information, see Appendix E *Fast Context Switch Extension (FCSE)*.
- An ARMv6K implementation requires the Software Thread ID registers described in *CP15 c13 Software Thread ID registers* on page B3-154.

Note

In ARMv6, after any change to the CONTEXTIDR or FCSEIDR, software must use the CP15 branch predictor maintenance operations to flush the virtual addresses affected by the change. If the branch predictor is not invalidated in this way, attempting to execute an old branch might cause UNPREDICTABLE behavior. ARMv7 does not require branch predictors to be invalidated after a change to the CONTEXTIDR or FCSEIDR.

G.7.22 c15, IMPLEMENTATION DEFINED

As in ARMv7, CP15 c15 is reserved for IMPLEMENTATION DEFINED use. Typically, it is used for processor-specific runtime and test features.

Appendix H

ARMv4 and ARMv5 Differences

This appendix describes how the ARMv4 and ARMv5 architectures differ from the ARMv6 and ARMv7 architectures. It contains the following sections:

- *Introduction to ARMv4 and ARMv5* on page AppxH-2
- *Application level register support* on page AppxH-4
- *Application level memory support* on page AppxH-6
- *Instruction set support* on page AppxH-11
- *System level register support* on page AppxH-18
- *System level memory model* on page AppxH-21
- *System Control coprocessor (CPI5) support* on page AppxH-31.

———— **Note** —————

In this appendix, the description ARMvN refers to all architecture variants of ARM architecture vN. For example, ARMv4 refers to all architecture variants of ARMv4, including ARMv4 and ARMv4T.

H.1 Introduction to ARMv4 and ARMv5

ARMv4 and ARMv5 defined the instruction set support and the programmers' model that applies to the general-purpose registers and the associated exception model. These architecture versions are fully described in the *ARM Architecture Reference Manual (DDI 0100)*.

Note

This appendix is a summary of the ARMv4 and ARMv5 architecture variants. It is expected that the majority of requirements for architecture information on ARMv4 and ARMv5 are satisfied by this appendix and the rest of this manual. However the *ARM Architecture Reference Manual (DDI 0100)* might be required for more information specific to ARMv4 or ARMv5.

Memory support is IMPLEMENTATION DEFINED in ARMv4 and ARMv5. In practice, use of CP15 to support the *Virtual Memory System Architecture (VMSA)* or *Protected Memory System Architecture (PMSA)* is standard in ARMv4 and ARMv5 implementations, but this is not an architectural requirement. For this reason, the datasheet or Technical Reference Manual for a particular ARM processor is the definitive source for its memory and system control facilities. This appendix does not specify absolute requirements on the functionality of CP15 or other memory system components. Instead, it contains guidelines designed to maximize compatibility with current and future ARM software.

This appendix concentrates on the features supported in ARMv4 and ARMv5, highlighting:

- features common across all architecture variants
- features supported for legacy reasons in ARMv6, but not in ARMv7
- features unique to the ARMv4 and ARMv5 variants.

H.1.1 Debug

Debug is not architecturally-defined in ARMv4 or ARMv5. ARM implementations have traditionally supported halting debug through a JTAG port. While the support of debug features is similar across ARM implementations, the timing and control sequencing required for access varies. Debug support in ARMv4 and ARMv5 is microarchitecture dependent and so in architectural terms is IMPLEMENTATION DEFINED.

H.1.2 ARMv6 and ARMv7

The ARM architecture was extended considerably in ARMv6. This means that a large proportion of this manual does not apply to earlier architecture variants and can be ignored with respect to ARMv4 and ARMv5.

The key changes in ARMv6:

- add:
 - the ARM SIMD instructions to improve execution of multimedia and other DSP applications
 - instructions for improved context switching.

- introduce:
 - a formal memory model, including level 1 cache support and revisions to alignment and endian support
 - a requirement to provide either a VMSA or a PMSA for memory management
 - a formal debug model
 - a requirement to support the CP15 System Control coprocessor
 - enhanced kernel support, in ARMv6K
 - the optional Security Extensions
 - 32-bit Thumb instructions, in ARMv6T2.

For information about the changes between ARMv6 and ARMv7 see Appendix G *ARMv6 Differences*.

H.2 Application level register support

The ARMv4 and ARMv5 core registers are the same as ARMv7. For more information, see *ARM core registers* on page A2-11. The following sections give more information about ARMv4 and ARMv5 application level register support:

- *APSR support*
- *Instruction set state.*

H.2.1 APSR support

Program status is reported in the 32-bit *Application Program Status Register (APSR)*. The format of the APSR is:

31	30	29	28	27	26	24	23	0													
N	Z	C	V	Q	RAZ/ SBZP	Reserved															

For details of the bit definitions, see *The Application Program Status Register (APSR)* on page A2-14. In the APSR descriptions:

- the GE[3:0] field is only defined from ARMv6, and is reserved in ARMv4 and ARMv5
- the Q bit is only defined from ARMv5TE, and is RAZ/WI in ARMv4, ARMv4T and ARMv5T.

Earlier versions of this manual do not use the term APSR. They refer to the APSR as the CPSR with the restriction on reserved fields governed by whether the register access was privileged.

H.2.2 Instruction set state

The instruction set states available in ARMv4 and ARMv5 are a subset of the states supported in ARMv7. All implementations support the ARM instruction set that executes in ARM state. All ARM instructions are 32-bit instructions. T variants of the architecture also support a 16-bit instruction set that executes in Thumb state. The supported ARM and Thumb instructions are summarized in *Instruction set support* on page AppxH-11.

Instruction set state support in ARMv4 and ARMv5 differs from the support available in ARMv7 as follows:

- ThumbEE state is not supported
- Jazelle state is supported only in ARMv5TEJ
- In privileged modes, you must take care not to attempt to change the instruction set state by writing nonzero values to CPSR.J and CPSR.T with an MSR instruction. For more information, see *Format of the CPSR and SPSRs* on page AppxG-17.

All ARMv4 and ARMv5 implementations support the ARM instruction set. ARMv4T, ARMv5T, ARMv5TE, and ARMv5TEJ also support a subset of the Thumb instruction set that can be executed entirely as 16-bit instructions. The only 32-bit instructions in this subset are restricted-range versions of the BL and BLX (immediate) instructions. See *BL and BLX (immediate) instructions, before ARMv6T2* on page AppxG-4 for a description of how these instructions can be executed as 16-bit instructions.

Instruction set support on page AppxH-11 summarizes the ARM and Thumb instructions supported in ARMv4 and ARMv5, and the instruction descriptions in Chapter A8 *Instruction Details* give details of the architecture variants that support each instruction encoding.

Interworking

In ARMv4T, the only instruction that supports interworking branches between ARM and Thumb states is BX.

In ARMv5T, the BLX instruction was added to provide interworking procedure calls. The LDR, LDM and POP instructions were modified to perform interworking branches if they load a value into the PC. This is described by the `LoadWritePC()` pseudocode function. See *Pseudocode details of operations on ARM core registers* on page A2-12.

H.3 Application level memory support

Memory support covers address alignment, endian support, semaphore support, memory type, memory order model, caches, and write buffers.

H.3.1 Alignment

ARMv4 and ARMv5 behave differently from ARMv7 for unaligned memory accesses. The behavior is the same as ARMv6 legacy mode except for forcing alignment checks with SCTL.R.A == 1.

For more information about the SCTL.R see *c1, System Control Register (SCTL.R)* on page AppxH-39.

For ARM instructions when SCTL.R.A == 0:

- Non halfword-aligned LDRH, LDRSH, and STRH are UNPREDICTABLE.
- Non word-aligned LDR, LDRT, and the load access of a SWP rotate right the word-aligned data transferred by a non word-aligned address one, two, or three bytes depending on the value of address[1:0].
- Non word-aligned STR, STRT, and the store access of a SWP ignore address[1:0].
- From ARMv5TE, it is IMPLEMENTATION DEFINED whether LDRD and STRD must be doubleword-aligned or word-aligned. LDRD and STRD instructions that do not meet the alignment requirement are UNPREDICTABLE.
- Non word-aligned LDM, LDC, LDC2, and POP ignore address[1:0].
- Non word-aligned STM, STC, STC2, and PUSH ignore address[1:0].

For Thumb instructions when SCTL.R.A == 0:

- Non halfword-aligned LDRH, LDRSH, and STRH are UNPREDICTABLE.
- Non word-aligned LDR, and STR are UNPREDICTABLE.
- Non word-aligned LDMIA, and POP ignore address[1:0].
- Non word-aligned STMIA, and PUSH ignore address[1:0].

For ARM and Thumb instructions, alignment checking is defined for implementations supporting CP15, specifically the SCTL.R.A bit. When this bit is set, a Data Abort exception indicating an Alignment fault is generated for unaligned accesses. When SCTL.R.A = 1, whether the alignment check for an LDRD or STRD instruction is for doubleword-alignment or word-alignment depends on the implementation choice of which alignments are supported for these instructions when SCTL.R.A = 0.

————— **Note** —————

The option of word alignment for LDRD and STRD instructions is not permitted in the ARMv6 legacy configuration where SCTL.R.U == 0 and SCTL.R.A == 1. For more information, see legacy alignment support in *Alignment* on page AppxG-6.

H.3.2 Endian support

ARMv4 and ARMv5 support big and little endian operation. Little endian support is consistent with ARMv7. Big endian control, configuration, and the connectivity of data bytes between the ARM register file and memory is different. However, the difference is only visible when communicating between big endian and little endian agents using memory. The agents can be different processors or programs running with different endianness settings on the same processor.

For ARMv4 and ARMv5, the distinction between big endian memory and little endian memory is managed by changing the addresses of the bytes in a word. For ARMv7, the distinction between big endian memory and little endian memory is managed by keeping the byte addresses the same, and reordering the bytes in the halfword or word. The endian formats are:

- LE** Little endian format used by ARMv4, ARMv5, ARMv6, and ARMv7
- BE** Big endian format used by ARMv6 (endianness controlled by the SETEND instruction) and ARMv7
- BE-32** Big endian format used by ARMv4, ARMv5, and ARMv6 (legacy format, endianness controlled by the SCTL.R.B bit).

Table H-1 shows how the addresses of bytes are changed in the BE-32 endian format. In this table, A is a doubleword-aligned address and S, T, U, V, W, X, Y, Z are the bytes at addresses A to A+7 in the ARMv7 memory map.

Table H-1 Addresses of bytes in endian formats

Byte	Address in format BE or LE	Address in format BE-32
S	A	A+3
T	A+1	A+2
U	A+2	A+1
V	A+3	A
W	A+4	A+7
X	A+5	A+6
Y	A+6	A+5
Z	A+7	A+4

Aligned memory accesses are performed using these byte addresses as shown in Table A3-4 on page A3-8 for the LE endian format and in Table A3-3 on page A3-7 for the BE and BE-32 formats, in each case extended consistently to doubleword accesses. Table H-2 on page AppxH-8 shows which bytes are accessed by each type of aligned memory access and the significance order in which they are accessed.

Table H-2 Bytes accessed by aligned accesses in endian formats

Memory access:		Bytes accessed in endian format:		
Size	Address	LE	BE	BE-32
Doubleword	A	ZYXWVUTS	STUVWXYZ	VUTSZYXW
Word	A	VUTS	STUV	VUTS
Word	A+4	ZYXW	WXYZ	ZYXW
Halfword	A	TS	ST	VU
Halfword	A+2	VU	UV	TS
Halfword	A+4	XW	WX	ZY
Halfword	A+6	ZY	YZ	XW
Byte	A	S	S	V
Byte	A+1	T	T	U
Byte	A+2	U	U	T
Byte	A+3	V	V	S
Byte	A+4	W	W	Z
Byte	A+5	X	X	Y
Byte	A+6	Y	Y	X
Byte	A+7	Z	Z	W

Note

If the ARMv4 and ARMv5 endian model was extended to unaligned word and halfword accesses, for example loading a word from byte addresses 0x1001, 0x1002, 0x1003, and 0x1004, it would not return the same bytes of data to a big endian and little endian agent. However, ARMv4 and ARMv5 do not support unaligned memory access and therefore this cannot occur. In ARMv4 and ARMv5 where use of an unaligned address is permitted, the actual memory access is naturally aligned. See *Alignment* on page AppxH-6.

In ARMv7, all big endian accesses return the same bytes of data from memory as the corresponding little endian accesses. It is only the byte order in the returned value that is different.

For an ARMv4 or ARMv5 implementation, whether the endianness of the memory access is fixed, defined by an input pin on reset, or controlled by the SCTL.R.B bit is IMPLEMENTATION DEFINED.

Examples

The distinction between BE and BE-32 is not visible if all agents use the same endian format, because a given memory address always accesses the same location in memory. However, if there are two agents with different endianness the effect is as shown in Example H-1 and Example H-2.

Example H-1 Distinction between BE and BE-32 word stores observed by an LE agent

In this example:

- Agent1 is big endian, R1=0x1000, R2=0x11223344
- Agent2 is little endian, R1=0x1000.

Agent1:

```
STR R2, [R1]
```

Agent2:

```
LDR R2, [R1]           // If Agent1 uses BE-32 endian format: R2 = 0x11223344
                       // If Agent1 uses BE endian format: R2 = 0x44332211
```

Example H-2 Distinction between BE and BE-32 byte stores observed by an LE agent

In this example:

- Agent1 is big endian, R1=0x1000, R2=0x44, R3=0x11
- Agent2 is little endian, R1=0x1000.

Agent1:

```
STRB R2, [R1]
STRB R3, [R1, #3]
```

Agent2:

```
LDRB R2, [R1]          // If Agent1 uses BE-32 endian format: R2 = 0x11
                       // If Agent1 uses BE endian format: R2 = 0x44
```

H.3.3 Semaphore support

The only semaphore support in ARMv4 and ARMv5 is provided by the SWP and SWPB ARM instructions. Use of these instructions is deprecated in ARMv6 and ARMv7 in favour of the exclusive access mechanism provided by LDREX, STREX, and related instructions.

H.3.4 Memory model and memory ordering

There is no formal definition of the memory model in ARMv4 and ARMv5. ARM implementations generally adopted a Strongly-ordered approach. However the memory order model is IMPLEMENTATION DEFINED.

Memory type support

In ARMv4 and ARMv5 where CP15 is implemented, memory can be tagged using two control bits:

- the B bit (Bufferable), to indicate whether write buffering between the processor and memory is permitted
- the C bit (Cacheable).

Table H-3 shows the ARMv4 and ARMv5 definitions of the C bit and B bit that are interpreted as the formal memory types defined in ARMv6 and ARMv7.

Table H-3 Interpretation of Cacheable and Bufferable bits

C	B	Memory type
0	0	Strongly-ordered
0	1	Device
1	0	Normal, Write-Through Cacheable
1	1	Normal, Write-Back Cacheable

H.4 Instruction set support

Two instruction sets are supported in ARMv4 and ARMv5:

- the ARM instruction set is supported by all variants of ARMv4 and ARMv5
- the Thumb instruction set is supported by ARMv4T, ARMv5T, ARMv5TE, and ARMv5TEJ.

Floating-point support, identified as VFPv2, was added as an option in ARMv5TE. The VFP instructions are a subset of the coprocessor support in the ARM instruction set, and use coprocessor numbers 10 and 11. The following instructions are not supported in VFPv2, and are specific to ARMv7 VFP support (VFPv3):

- VMOV (immediate)
- VCVT (between floating-point and fixed-point).

Note

- VFP instruction mnemonics traditionally started with an F. However this has been changed to a V prefix in the Unified Assembler Language introduced in ARMv6T2, and in many cases the rest of the mnemonic has been changed to be more compatible with other instructions mnemonics. This aligns the scalar floating-point support with the ARMv7 Advanced SIMD support, which shares some load/store and move operations to a common register file.
 - The VFPv2 instructions are summarized in *F** (*former VFP instruction mnemonics*) on page A8-100. This includes the two deprecated instructions in VFPv2 that do not have UAL mnemonics, the FDMX and FSTMX instructions.
-

The instruction sets have grown significantly in ARMv6 and ARMv7 because of:

- the introduction of ARMv6 SIMD
- improved context switching in ARMv6
- the addition of many 32-bit Thumb instructions in ARMv6T2 and ARMv7
- the ThumbEE extension in ARMv7
- addition of the SMC instruction with the Security Extensions
- the Advanced SIMD extension in ARMv7.

The ARM and Thumb instruction encodings including the VFP instructions are defined in *Alphabetical list of instructions* on page A8-14.

Note

This appendix describes the instructions included as a mnemonic in ARMv4 and ARMv5. For any mnemonic, to determine which associated instruction encodings appear in a particular architecture variant, see the subsections of *Alphabetical list of instructions* on page A8-14 that describe the mnemonic. Each encoding diagram shows the architecture variants or extensions that include the encoding.

The following sections give more information about ARMv4 and ARMv5 instruction set support:

- *ARM instruction set support* on page AppxH-12
- *Thumb instruction set support* on page AppxH-15
- *System level instruction set support* on page AppxH-17.

H.4.1 ARM instruction set support

Table H-4 shows the ARM instructions supported in ARMv4 and ARMv5, excluding VFP instructions.

Table H-4 ARM instructions - ARMv4 and ARMv5

Instruction	v4, v4T, v5T	v5TE, v5TEJ
ADC	Yes	Yes
ADD	Yes	Yes
AND	Yes	Yes
B	Yes	Yes
BIC	Yes	Yes
BKPT	v5T only	Yes
BL	Yes	Yes
BLX	v5T only	Yes
BX	v4T and v5T only	Yes
BXJ	No	v5TEJ only
CDP	Yes	Yes
CDP2	v5T only	Yes
CLZ	v5T only	Yes
CMN	Yes	Yes
CMP	Yes	Yes
EOR	Yes	Yes
LDC	Yes	Yes
LDC2	v5T only	Yes
LDM	Yes	Yes
LDR	Yes	Yes
LDRB	Yes	Yes
LDRD	No	Yes

Table H-4 ARM instructions - ARMv4 and ARMv5 (continued)

Instruction	v4, v4T, v5T	v5TE, v5TEJ
LDRBT	Yes	Yes
LDRH	Yes	Yes
LDRSB	Yes	Yes
LDRSH	Yes	Yes
LDRT	Yes	Yes
MCR	Yes	Yes
MCR2	v5T only	Yes
MCRR	No	Yes
MLA ^a	Yes	Yes
MOV	Yes	Yes
MRC	Yes	Yes
MRC2	v5T only	Yes
MRRC	No	Yes
MRS	Yes	Yes
MSR	Yes	Yes
MUL ^a	Yes	Yes
MVN	Yes	Yes
ORR	Yes	Yes
PLD	No	Yes
QADD	No	Yes
QDADD	No	Yes
QDSUB	No	Yes
QSUB	No	Yes
RSB	Yes	Yes

Table H-4 ARM instructions - ARMv4 and ARMv5 (continued)

Instruction	v4, v4T, v5T	v5TE, v5TEJ
RSC	Yes	Yes
SBC	Yes	Yes
SMLAL ^b	Yes	Yes
SMLABB, SMLABT, SMLATB, SMLATT	No	Yes
SMLALBB, SMLALBT, SMLALTB, SMLALTT	No	Yes
SMLAWB, SMLAWT	No	Yes
SMULBB, SMULBT, SMULTB, SMULTT	No	Yes
SMULL ^b	Yes	Yes
SMULWB, SMULWT	No	Yes
STC	Yes	Yes
STC2	v5T only	Yes
STM	Yes	Yes
STR	Yes	Yes
STRB	Yes	Yes
STRBT	Yes	Yes
STRD	No	Yes
STRH	Yes	Yes
STRT	Yes	Yes
SUB	Yes	Yes
SVC (previously SWI)	Yes	Yes
SWP	Yes	Yes
SWPB	Yes	Yes
TEQ	Yes	Yes

Table H-4 ARM instructions - ARMv4 and ARMv5 (continued)

Instruction	v4, v4T, v5T	v5TE, v5TEJ
TST	Yes	Yes
UMLAL ^b	Yes	Yes
UMULL ^b	Yes	Yes

- a. The value of APSR.C generated by flag-setting versions of these instructions is UNKNOWN in ARMv4 and is unchanged from ARMv5.
- b. The values of APSR.C and APSR.V generated by flag-setting versions of these instructions are UNKNOWN in ARMv4 and are unchanged from ARMv5.

H.4.2 Thumb instruction set support

Table H-5 shows the 16-bit Thumb instructions supported in ARMv4 and ARMv5. ARMv4 before ARMv4T does not support any Thumb instructions.

Table H-5 ARMv4 and ARMv5 support for Thumb instructions

Instruction	v4T	v5T, v5TE, v5TEJ
ADC	Yes	Yes
ADD	Yes	Yes
AND	Yes	Yes
ASR	Yes	Yes
B	Yes	Yes
BIC	Yes	Yes
BKPT	No	Yes
BL	Yes	Yes
BLX	No	Yes
BX	Yes	Yes
CMN	Yes	Yes
CMP	Yes	Yes
EOR	Yes	Yes

Table H-5 ARMv4 and ARMv5 support for Thumb instructions (continued)

Instruction	v4T	v5T, v5TE, v5TEJ
LDMIA	Yes	Yes
LDR	Yes	Yes
LDRB	Yes	Yes
LDRH	Yes	Yes
LDRSB	Yes	Yes
LDRSH	Yes	Yes
LSL	Yes	Yes
LSR	Yes	Yes
MOV	Yes	Yes
MUL	Yes	Yes
MVN	Yes	Yes
NEG	Yes	Yes
ORR	Yes	Yes
POP	Yes	Yes
PUSH	Yes	Yes
ROR	Yes	Yes
SBC	Yes	Yes
STMIA	Yes	Yes
STR	Yes	Yes
STRB	Yes	Yes
STRH	Yes	Yes
SUB	Yes	Yes
SVC (previously SWI)	Yes	Yes
TST	Yes	Yes

H.4.3 System level instruction set support

The register and immediate forms of the MRS and MSR instructions are used to manage the CPSR and SPSR as applicable. Other system level instructions are:

- LDM (exception return) and LDM (user registers)
- LDRBT and LDRT
- STM (user registers)
- STRBT and STRT
- SUBS PC, LR and related instructions
- VMRS and VMSR where VFP is supported.

All system level support is from ARM state.

H.5 System level register support

The general registers and programming modes are the same as ARMv7, except that the Security Extensions and Monitor mode are not supported. For more information, see Figure B1-1 on page B1-9. The following sections give information about ARMv4 and ARMv5 system level register support:

- *Program Status Registers (PSRs)*
- *The exception model* on page AppxH-19
- *Execution environment support* on page AppxH-20.

H.5.1 Program Status Registers (PSRs)

The application level programmers' model provides the *Application Program Status Register (APSR)*. See *The Application Program Status Register (APSR)* on page A2-14. This is an application level alias for the CPSR. The system level view of the CPSR extends the register, adding state that:

- is used by exceptions
- controls the processor mode.

Each of the exception modes has its own saved copy of the CPSR, the *Saved Program Status Register (SPSR)*, as shown in Figure B1-1 on page B1-9. For example, the SPSR for Abort mode is called SPSR_abt.

Note

ARMv4 and ARMv5 do not support Monitor mode and the Security Extensions.

The Current Program Status Register (CPSR)

The CPSR holds the following processor status and control information:

- The APSR, see *APSR support* on page AppxH-4
- The current instruction set state. See *ISSETSTATE* on page A2-15, except that:
 - ThumbEE state is not supported
 - Jazelle state is supported only in ARMv5TEJ.
- The current processor mode
- Interrupt disable bits.

The non-APSR bits of the CPSR have defined reset values. These are shown in the `TakeReset()` pseudocode function described in *Reset* on page B1-48, except that:

- the CPSR.IT[7:0], CPSR.E and CPSR.A bits are not defined and so do not have reset values
- before ARMv5TEJ, the CPSR.J bit is not defined and so does not have a reset value
- the reset value of CPSR.T is 0.

The rules described in *The Current Program Status Register (CPSR)* on page B1-14 about when mode changes take effect apply with the modification that the ISB can only be the ISB operation described in *c7, Miscellaneous functions* on page AppxH-51.

The ARM abort model

ARMv6 and ARMv7 use a *Base Restored Abort Model* (BRAM). However, in ARMv5 and ARMv4 it is IMPLEMENTATION DEFINED whether this model, or a *Base Updated Abort Model* (BUAM) is used. These two abort models are defined as:

Base Restored Abort Model

The base register of any valid load/store instruction that causes a memory system abort is always restored to the value it had immediately before that instruction.

Base Updated Abort Model

After an abort, the base register of any valid load/store instruction that causes a memory system abort is modified by the base register writeback, if any, of that instruction.

The implemented abort model applies uniformly across all instructions.

Exception entry

Entry to exceptions in ARMv4 and ARMv5 is generally as described in the sections:

- *Reset* on page B1-48
- *Undefined Instruction exception* on page B1-49
- *Supervisor Call (SVC) exception* on page B1-52
- *Secure Monitor Call (SMC) exception* on page B1-53
- *Prefetch Abort exception* on page B1-54
- *Data Abort exception* on page B1-55
- *IRQ exception* on page B1-58
- *FIQ exception* on page B1-60.

These ARMv7 descriptions are modified as follows:

- pseudocode statements that set registers, bits and fields that do not exist in the ARMv4 or ARMv5 architecture variant are ignored
- CPSR.T is set to 0, not to SCTLR.TE.

H.5.3 Execution environment support

In ARMv5TEJ, the JOSCR.CV bit is not changed on exception entry in any implementation of Jazelle.

H.6 System level memory model

The pseudocode listed in *Aligned memory accesses* on page B2-31 and *Unaligned memory accesses* on page B2-32 covers the alignment behavior of all architecture variants from ARMv4. For ARMv4 and ARMv5, SCTL.R.U is zero, see *Alignment* on page AppxG-6.

The following sections describe the system level memory model:

- *Cache support*
- *Tightly Coupled Memory (TCM) support*
- *Virtual memory support*
- *Protected memory support* on page AppxH-28.

H.6.1 Cache support

CP15 operations are defined that provide cache operations for managing level 1 instruction, data, or unified caches. Caches can be direct mapped or N-way associative. ARMv4 and ARMv5 define a Cache Type ID Register, to enable software to determine the level 1 cache topology.

ARMv4 and ARMv5 support virtual (virtually indexed, virtually tagged) or physical caches. In a virtual memory system that supports virtual cache or caches, there is no coherence support for virtual aliases that map to the same physical address. When a virtual to physical address mapping changes, caches must be cleaned and invalidated accordingly.

Cache management and flushing of any write buffer in the processor is IMPLEMENTATION DEFINED and managed by CP15. CP15 also supports configuration and control of cache lockdown. For more information on cache management support see *System Control coprocessor (CP15) support* on page AppxH-31, and *c7, Cache operations* on page AppxH-49 and *c9, cache lockdown support* on page AppxH-52.

H.6.2 Tightly Coupled Memory (TCM) support

TCM support in ARMv4 and ARMv5 is IMPLEMENTATION DEFINED.

H.6.3 Virtual memory support

The ARMv4 and ARMv5 translation tables support a similar two level translation table format to the ARMv7 tables. However, there are significant differences in the translation table format because of the following:

- ARMv6 introduced additional bits for encoding memory types, attributes, and extended cache attributes.
- The new translation table format in ARMv6 does not support subpage access permissions.
- ARMv4 does not support 16MB Supersections.
- Only ARMv4 and ARMv5 support tiny (1KB) pages. The fine second level page format is not supported from ARMv6.

For general information about address translation in a VMSA, see *About the VMSA* on page B3-2

The *Fast Context Switch Extension* (FCSE) is an implementation option in ARMv4 and ARMv5 VMSA implementations. For more information, see *FCSE translation* on page B3-4 and Appendix E *Fast Context Switch Extension (FCSE)*.

Note

ARMv7 only supports the new translation table format. ARMv6 supports both old and new formats and uses SCTLR[23] to select which format to use. For more information, see *c1, System Control Register (SCTLR)* on page AppxG-34.

The *Virtual Memory System Architecture* (VMSA) in ARMv4 and ARMv5 supports the following:

- 16MB Supersections, optional support from ARMv5TE
- 1MB Sections
- 64KB Large pages
- 4KB Small pages
- 1KB Tiny pages.

Section virtual to physical address translation is supported by a single level translation table walk. Page address translation requires a two level translation table walk. Each level involves an aligned word read from a translation table in memory with the first level translation table base address held in a CP15 register, TTBR0. Translation table entries are typically cached in a *Translation Lookaside Buffer* (TLB) in the *Memory Management Unit* (MMU) of a given implementation. CP15 operations are used to manage the TLB. For more information, see *c8, VMSA TLB support* on page AppxH-51.

Note

ARMv4 and ARMv5 support a single translation table base address register. TTBR1 and TTBCR were introduced in ARMv6.

Second level translation table accesses are derived from the additional information provided by the first level translation table entry. Two sizes of second level translation table are supported:

- a Coarse page table, where each entry translates a 4KB address space
- a Fine page table, where each entry translates a 1KB address space.

Translation tables are always naturally aligned in memory to the address space they occupy. This means that the least significant n bits of the translation table base address are zero, where $n = \log_2(\text{SIZE})$, and SIZE is the size of the table in bytes.

Translation attributes

ARMv4 and ARMv5 support the following translation table attributes:

- domain access as described in *Domains* on page B3-31
- cacheability with the C and B bits, see *Interpretation of Cacheable and Bufferable bits* on page AppxH-10

- access permissions using the AP[1:0], SCTL.R.S and SCTL.R.R bits as defined in Table H-6 on page AppxH-23
- from ARMv5TE, the option of marking sections as Shareable and support for extended cache attributes using the TEX bitfield with the C and B bits. See Table H-7 and Table H-8 on page AppxH-25.

Table H-6 VMSA access permissions in ARMv4 and ARMv5

SCTL ^a		AP[1:0]	Privileged permissions	User permissions	Description
S	R				
0	0	00	No access	No access	All accesses generate Permission faults
x	x	01	Read/write	No access	Privileged access only
x	x	10	Read/write	Read-only	Writes in User mode generate Permission faults
x	x	11	Read/write	Read/write	Full access
0	1	00	Read-only	Read-only	Read-only in privileged and User modes
1	0	00	Read-only	No access	Privileged read-only
1	1	00	-	-	Reserved

a. For more information, see *c1, System Control Register (SCTLR)* on page AppxH-39.

———— **Note** ————

Changes to the S and R bits do not affect the access permissions of entries already in the TLB. The TLB must be flushed for the updated S and R bit values to take effect.

First level descriptor formats

Table H-7 shows the translation table first level descriptor formats:

- Supersection support, the TEX field, and the S bit are only permitted from ARMv5TE. Where these features are not supported, the corresponding bits must be zero.
- Supersections can support address translation from a 32-bit virtual address to a physical address of up to 40 bits.

Table H-7 ARMv4 and ARMv5 first level descriptor format

	31	24	23	20	19	15	14	12	11	10	9	8	5	4	3	2	1	0	
Fault	Ignore																	0	0
Coarse page table	Coarse page table base address											P	Domain	SBZ		0	1		
Section	Section base address				S B Z	0	S B Z	S ^a	S B Z	TEX ^b	AP	P	Domain	S B Z	C	B	1	0	
Supersection	Supersection base address		PA[35:32] optional	S B Z	1	S B Z	S	S B Z	TEX	AP	P	PA[39:36] optional	S B Z	C	B	1	0		
Fine page table	Fine page table base address										SBZ	P	Domain	SBZ		1	1		

- a. S=1 indicates Shareable memory. For more information, see *Summary of ARMv7 memory attributes* on page A3-25.
 b. From ARMv5TE, the TEX bits can be used with the C and B bits as described in *C, B, and TEX[2:0] encodings without TEX remap* on page B3-33.

Bits [1:0] of the descriptor identify the descriptor type:

- 0b00** Invalid or fault entry.
- 0b01** Coarse page table descriptor. Bits [31:10] of the descriptor give the physical address of a second level translation table.
- 0b10** Section or Supersection descriptor for the associated Modified Virtual Address (MVA). Bits [31:20] of the descriptor give the Section address, bits [31:24] provide the Supersection address. Bit [18] indicates which to use when both are supported.
- 0b11** Fine page table descriptor. Bits [31:12] of the descriptor give the physical address of a second level translation table.

Second level Fine page table descriptor format

In a Fine page table, each entry provides translation information for 1KB of memory. Large page table entries must be repeated 64 times and Small page entries four times to ensure translation of all addresses. Fine tables are 4KB in size and must be aligned on a 4KB boundary.

Table H-9 shows the translation table second level descriptor format for a second level Fine page table.

Table H-9 Second level Fine page table descriptor format

	31		16	15		12	11	10	9	8	7	6	5	4	3	2	1	0
Fault	Ignore																0	0
Large page	Large page base address				SBZ	AP3	AP2	AP1	AP0	C	B	0	1					
Small page	Small page base address					AP3	AP2	AP1	AP0	C	B	1	0					
Tiny page	Tiny page base address						SBZ		AP	C	B	1	1					

Bits [1:0] of the descriptor identify the descriptor type:

- 0b00** Invalid or fault entry. The associated MVA is unmapped, and attempting to access it generates a Translation fault.
- 0b01** Large page descriptor. Bits [31:16] of the descriptor give the base address of the Large page.
- 0b10** Small page descriptor. Bits [31:12] of the descriptor give the base address of the Small page.
- 0b11** Tiny page descriptor. Bits [31:10] of the descriptor give the base address of the Tiny page.

Subpage support

In the Large page and Small page formats in Table H-9, the page is divided into four equal sized subpages. The AP0, AP1, AP2, and AP3 fields are the AP bits for subpages 0, 1, 2, and 3 respectively. Subpage 0, controlled by the AP0 field, is the subpage with the lowest base address.

Translation table walks

An MVA and TTBR0 are used to access translation table information as follows:

- For a Section translation. See Figure B3-4 on page B3-17 with $N == 0$.
- For a Large page translation using a Coarse page table access. See Figure B3-7 on page B3-20 with $N == 0$.
- For a Small page translation using a Coarse page table access. See Figure B3-6 on page B3-19 with $N == 0$.
- For a Tiny page translation using a Fine page table access. See Figure H-1.

Note

A Large page table or Small page table translation is performed on a Fine page table access by reducing the second level page table base address to bits [31:12] and extending the second level table index to MVA[19:10].

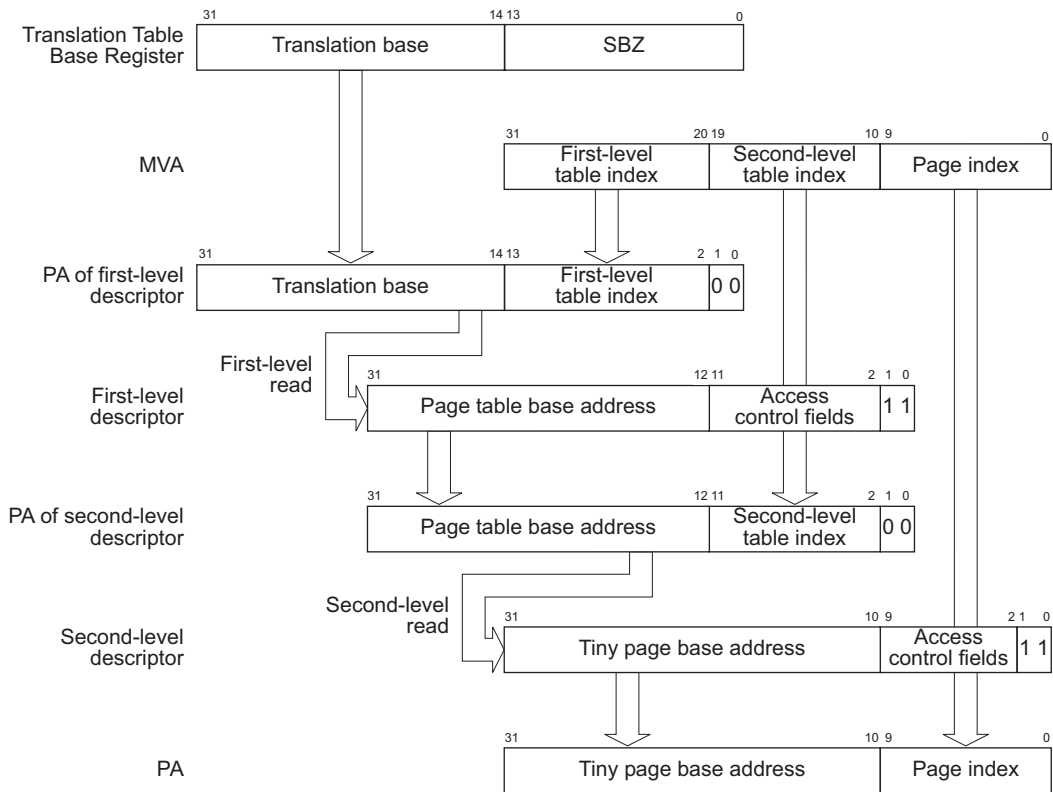

Figure H-1 Tiny page address translation, VMSAv5 and VMSAv4 only

H.6.4 Protected memory support

The MPU based *Protected Memory System Architecture* (PMSA) is a much simpler memory protection scheme than the MMU-based VMSA model described in *Virtual memory support* on page AppxH-21. The simplification applies to both the hardware and the software. PMSA in ARMv4 and ARMv5 differs from that supported in ARMv6 and ARMv7 in the following ways:

- the programming model is unique to ARMv4 and ARMv5
- the supported number of memory regions is fixed
- background memory support requires use of a region resource
- there is no architecturally-defined recovery mechanism from memory aborts
- there is no default memory map definition.

Control and configuration

CP15 registers are used to fully define *protection regions*, eliminating the VMSA requirements for hardware to do translation table walks, and for software to set up and maintain the translation tables. This makes memory checking fully deterministic. However, the level of control is now region based rather than page based. This means the control is not as fine-grained.

The following features apply:

- The memory is divided into regions. CP15 registers are used to define the region size, base address, and memory attributes. For example, cacheability, bufferability, and access permissions of a region.
- Memory region control (read and write access) is permitted only from privileged modes.
- If an address is defined in multiple regions, a fixed priority scheme (highest region number) is used to define the properties of the address being accessed.
- An access to an address that is not defined in any region causes a memory abort.
- All addresses are physical addresses. Address translation is not supported.
- PMSA supports unified (von Neumann) and separate (Harvard) instruction and data address spaces.

Eight regions can be configured, with C, B, and AP[1:0] attribute bits associated with each region. The supported region sizes are 2NKB, where $2 \leq N \leq 32$. It is IMPLEMENTATION DEFINED if the regions are configurable or fixed in an implementation:

- as eight unified regions supporting data accesses and instruction fetches
- as eight data regions and eight instruction regions each with independent memory region attributes.

CP15 provides the following support:

- a global MPU enable bit, SCTL.R.M
- cacheability register support, a C bit for each region
- bufferability register support, a B bit for each region

- access permission register support that provides AP7[1:0] to AP0[1:0] 2-bit permission fields, an AP bitfield for each region
- optional extended access permission register support for 4-bit AP fields
- region registers providing a base address, size field, and an enable bit for each region.

For details of the PMSA support in CP15 see *c2, c3, c5, and c6, PMSA support* on page AppxH-43.

The C and B bits are configured according to the type of memory that is to be accessed. For more information, see *Memory type support* on page AppxH-10. Table H-10 defines the standard AP bit behavior.

Table H-10 PMSA access permissions in ARMv4 and ARMv5

AP[1:0]	Privileged permissions	User permissions	Description
00	No access	No access	All accesses generate Permission faults
01	Read/write	No access	Privileged access only
10	Read/write	Read-only	Writes in User mode generate Permission faults
11	Read/write	Read/write	Full access

Some implementations also include support for read-only access permission. Table H-11 defines the extended AP bit behavior.

Table H-11 PMSA extended access permissions in ARMv4 and ARMv5

AP[3:0]	Privileged permissions	User permissions	Description
0000	No access	No access	All accesses generate a Permission fault
0001	Read/write	No access	Privileged access only
0010	Read/write	Read-only	Writes in User mode generate a Permission fault
0011	Read/write	Read/write	Full access
0100	UNPREDICTABLE	UNPREDICTABLE	-
0101	Read-only	No access	Privileged read-only access
0110	Read-only	Read-only	Read-only access
0111	UNPREDICTABLE	UNPREDICTABLE	-
1xxx	UNPREDICTABLE	UNPREDICTABLE	-

Memory access sequence

When the ARM processor generates a memory access, the MPU compares the memory address with the programmed memory regions as follows:

- If a matching memory region is not found, a memory abort is signaled to the processor.
- If a matching memory region is found, the region information is used as follows:
 - The access permission bits are used to determine whether the access is permitted. If the access is not permitted, the MPU signals a memory abort. Otherwise, the access can proceed.
 - The memory region attributes are used to determine the access attributes, for example cached or non-cached, as described in *Memory type support* on page AppxH-10.

Note

When a Permission fault occurs, there is no fault status information provision for PMSA in ARMv4 or ARMv5. The CP15 registers FSR and FAR are only available in implementations with VMSA support.

Overlapping regions

The Protection Unit can be programmed with two or more overlapping regions. When overlapping regions are programmed, a fixed priority scheme is applied to determine the region whose attributes are applied to the memory access.

Attributes for region 7 take highest priority and those for region 0 take lowest priority. For example:

- Data region 2 is programmed to be 4KB in size, starting from address 0x3000 with AP == 0b010 (privileged modes full access, User mode read-only).
- Data region 1 is programmed to be 16KB in size, starting from address 0x0 with AP == 0b001 (privileged mode access only).

When the processor performs a data load from address 0x3010 while in User mode, the address falls into both region 1 and region 2. Because there is a clash, the attributes associated with region 2 are applied. In this case, the load would not abort.

Background region

Overlapping regions increase the flexibility of how regions can be mapped onto physical memory devices in the system. The overlapping properties can also be used to specify a background region. For example, assume a number of physical memory areas sparsely distributed across the 4GB address space. If only these regions are configured, any access outside the defined sparse address space aborts. You can override this behavior by programming region 0 to be a 4GB background region. In this case, if the address does not fall into any of the other regions, the access is controlled by the attributes specified for region 0.

H.7 System Control coprocessor (CP15) support

Before ARMv6, it is IMPLEMENTATION DEFINED whether a System Control coprocessor, CP15, is implemented. However, support of ID registers, control registers, cache support, and memory management with virtual or protected memory support resulted in the widespread adoption of a standard for control and configuration of these features. That standard is described here. With the exception of a small number of operations and supporting registers, for example the memory barrier operations described in *c7, Miscellaneous functions* on page AppxH-51, all CP15 accesses require privileged access.

The following sections summarize the CP15 registers known to have been supported in ARMv4 or ARMv5 implementations:

- *Organization of CP15 registers in an ARMv4 or ARMv5 VMSA implementation* on page AppxH-32
- *Organization of CP15 registers in an ARMv4 or ARMv5 PMSA implementation* on page AppxH-33.

For details of the registers provided by a particular implementation see the appropriate Technical Reference Manual, or other product documentation.

The rest of this section describes the ARMv4 and ARMv5 CP15 support in order of the CRn value.

———— **Note** —————

Definitions of CP15 registers in this appendix apply to both VMSA and PMSA implementations unless otherwise indicated.

H.7.1 Organization of CP15 registers in an ARMv4 or ARMv5 VMSA implementation

Figure H-2 shows the CP15 registers in an ARMv4 or ARMv5 VMSA implementation:

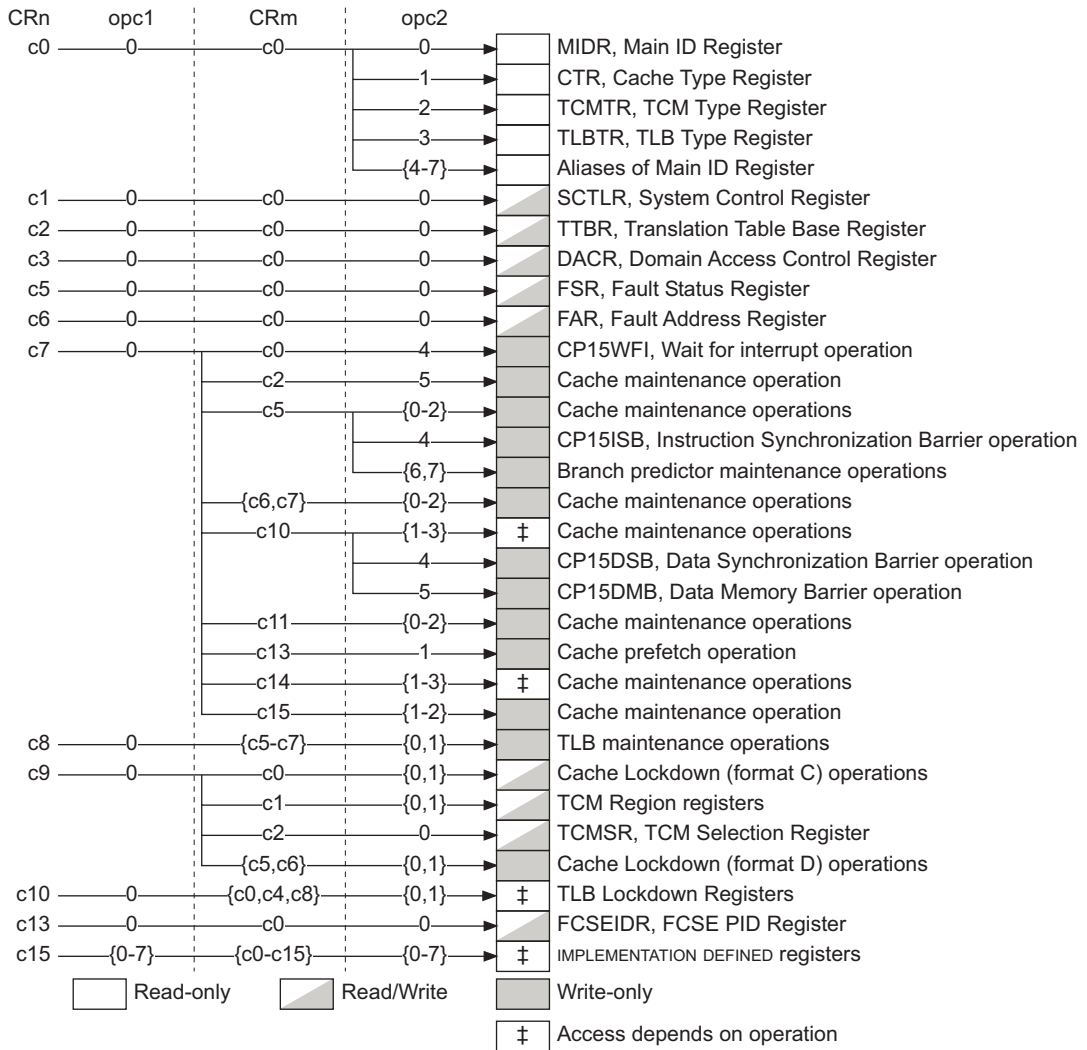

Figure H-2 CP15 registers in a VMSAv4 or VMSAv5 implementation

H.7.2 Organization of CP15 registers in an ARMv4 or ARMv5 PMSA implementation

Figure H-3 shows the CP15 registers in an ARMv4 or ARMv5 PMSA implementation:

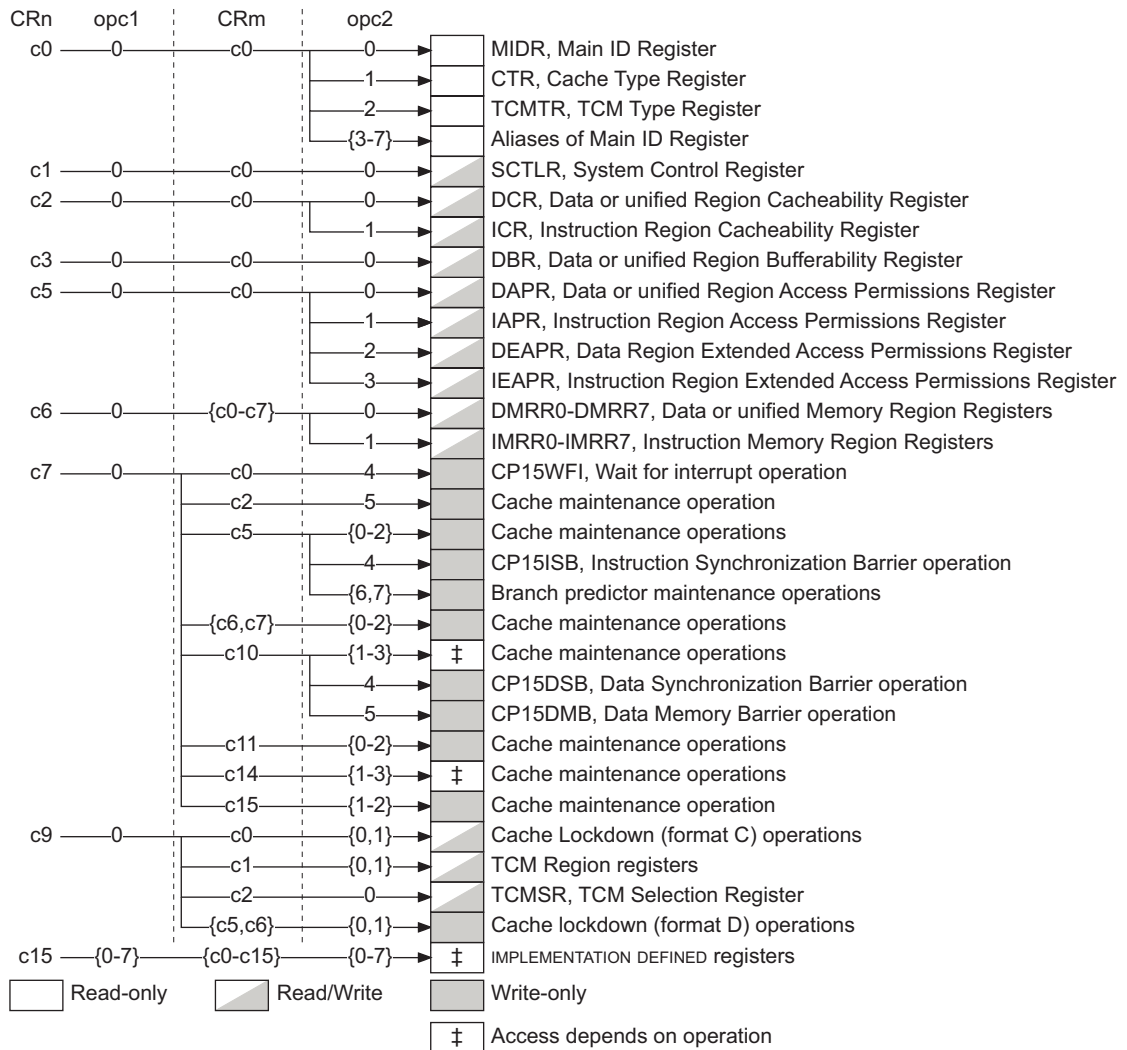

Figure H-3 CP15 registers in a PMSAv4 or PMSAv5 implementation

H.7.3 c0, ID support

ARMv4 and ARMv5 implementations support the following ID registers:

- *Main ID Register (MIDR)*. See *c0, Main ID Register (MIDR)*.
- *Cache Type Register (CTR)*. See *c0, Cache Type Register (CTR)* on page AppxH-35.
- Optionally, the *TCM Type Register (TCMTR)*. See *c0, TCM Type Register (TCMTR)* on page AppxH-38.

Table H-12 shows how these read-only registers are accessed using the MRC instruction.

Table H-12 ID register support

Register	CRn	opc1	CRm	opc2
Main ID Register, MIDR	c0	0	c0	0
Cache Type ID Register, CTR,	c0	0	c0	1
TCM Type Register, TCMTR	c0	0	c0	2
Aliases of MIDR	c0	0	c0	3, 4, 5, 6, 7

c0, Main ID Register (MIDR)

This register is as described for ARMv7 if either:

- the implementer code in MIDR bits [31:24] is not 0x41
- the top four bits of the primary part number in MIDR bits [15:4] are neither 0x0 nor 0x7.

If the implementer code is 0x41 and the top four bits of the primary part number are 0x0, the processor is an obsolete ARMv2 or ARMv3 processor.

If the implementer code is 0x41 and the top four bits of the primary part number are 0x7, then:

- If bit[23] is 0, the processor is an obsolete ARMv3 processor.
- If bit[23] is 1, the processor is an ARMv4T processor and bits[22:16] are an IMPLEMENTATION DEFINED variant number. Bits[31:24,15:0] are as described for ARMv7.

For the ARMv7 descriptions of the MIDR see:

- *c0, Main ID Register (MIDR)* on page B3-81 for a VMSA implementation
- *c0, Main ID Register (MIDR)* on page B4-32 for a PMSA implementation.

c0, Cache Type Register (CTR)

The format of the Cache Type Register is significantly different from the ARMv7 definition described in *c0, Cache Type Register (CTR)* on page B3-83. However, the general properties described by the register, and the access rights for the register, are unchanged.

This section describes the implementation of the CP15 c0 Cache Type Register and is applicable to a VMSA or PMSA implementation.

The Cache Type Register supplies the following details about the level 1 cache implementation:

- whether there is a unified cache or separate instruction and data caches
- the cache size, line length, and associativity
- whether it is a Write-Through cache or a Write-Back cache
- the cache cleaning and lockdown capabilities.

The format of the Cache Type Register is:

31	29	28	25	24	23	12	11	0
0	0	0	Ctype	S	DSize			ISize

Ctype, bits [28:25]

Cache type field. Specifies details of the cache not indicated by the S bit and the Dsize and Isize fields. Table H-13 shows the encoding of this field. All values not specified in the table are reserved.

S, bit [24] Separate caches bit. The meaning of this bit is:

- 0** Unified cache
- 1** Separate instruction and data caches.

If S == 0, the Isize and Dsize fields both describe the unified cache, and must be identical.

Dsize, bits [23:12]

Specifies the size, line length and associativity of the data cache, or of the unified cache if S == 0. For details of the encoding see *Cache size fields* on page AppxH-36.

Isize, bits [11:0]

Specifies the size, line length and associativity of the instruction cache, or of the unified cache if S == 0. For details of the encoding see *Cache size fields* on page AppxH-36.

Table H-13 shows the Ctype values that can be used in the CTR:

Table H-13 Cache type values

Ctype ^a	Cache method	Cache lockdown ^b
0b0000	Write-Through	Not supported
0b0010	Write-Back	Not supported

Table H-13 Cache type values (continued)

Ctype ^a	Cache method	Cache lockdown ^b
0b0101	Write-Back	Format D
0b0110 ^c	Write-Back	Format A
0b0111 ^c	Write-Back	Format B
0b1110	Write-Back	Format C

- a. CType values not shown are reserved and must not be used.
b. For details see *c9, cache lockdown support* on page AppxH-52.
c. In ARMv6 this CType value is reserved and must not be used.

For details of the CP15 *c7* operations used for cleaning Write-Back caches see *c7, Cache operations* on page AppxH-49.

Cache size fields

The Dsize and Isize fields in the CTR have the same format:

23	22	21	18	17	15	14	13	12
11	10	9	6	5	3	2	1	0
P	0	Size	Assoc	M	Len			

P For a VMSA implementation, indicates whether the allocation of bits [13:12] of the virtual address is restricted, imposing the *page coloring* restriction. The meaning of this field is:

- 0** No restriction, or PMSA implementation
1 Page coloring restriction applies, see *Virtual to physical translation mapping restrictions* on page AppxG-26.

Size Indicates the size of the cache, but is qualified by the M bit, see Table H-14 on page AppxH-37.

Assoc Indicates the associativity of the cache, but is qualified by the M bit, see *Cache associativity* on page AppxH-37.

M Qualifies the values in the Size and Assoc subfields.

Len Specifies the line length of the cache. The possible values of this field are:

- 0b00** Line length is 2 words (8 bytes)
0b01 Line length is 4 words (16 bytes)
0b10 Line length is 8 words (32 bytes)
0b11 Line length is 16 words (64 bytes).

Table H-14 shows how the size of the cache is determined by the Size field and M bit.

Table H-14 Cache sizes

Size field	Size if M == 0	Size if M == 1
0b0000	0.5KB	0.75KB
0b0001	1KB	1.5KB
0b0010	2KB	3KB
0b0011	4KB	6KB
0b0100	8KB	12KB
0b0101	16KB	24KB
0b0110	32KB	48KB
0b0111	64KB	96KB
0b1000	128KB	192KB

Cache associativity

Table H-15 show how the associativity of the cache is determined by the Assoc field and the M bit.

Table H-15 Cache associativity

Assoc field	Associativity if:	
	M == 0	M == 1
0b000	1 way (direct mapped)	Cache absent
0b001	2 way	3 way
0b010	4 way	6 way
0b011	8 way	12 way
0b100	16 way	24 way
0b101	32 way	48 way
0b110	64 way	96 way
0b111	128 way	192 way

The Cache absent encoding overrides all other data in the cache size field.

Excluding the cache absent case (Assoc == 0b000, M == 1) you can use the following formulae to determine the values LINELEN, ASSOCIATIVITY, and NSETS (number of sets) from the Size, Assoc and Len fields of the CTR. These formulae give the associativity values shown in Table H-15 on page AppxH-37:

```

LINELEN      = 1 << (Len+3)           /* In bytes */
MULTIPLIER   = 2 + M
NSETS        = 1 << (Size + 6 - Assoc - Len)
ASSOCIATIVITY = MULTIPLIER << (Assoc - 1)

```

Multiplying these together gives the overall cache size as:

```

CACHE_SIZE   = MULTIPLIER << (Size+8) /* In bytes */

```

————— **Note** —————

Cache length fields with (Size + 6 - Assoc - Len) < 0 are invalid, because they correspond to impossible combinations of line length, associativity, and overall cache size. So the formula for NSETS never involves a negative shift value.

c0, TCM Type Register (TCMTR)

In an ARMv4 or ARMv5 implementation that supports CP15 and TCM, the TCMTR is an optional register. For details of the TCMTR implementation see *c0, TCM Type Register (TCMTR)* on page AppxG-33.

H.7.4 c1, System control register support

ARMv4 and ARMv5 implementations support the following system control registers:

- a System Control Register (SCTLR)
- an IMPLEMENTATION DEFINED Auxiliary Control Register (ACTLR).

Table H-16 shows how the registers are accessed using the MCR and MRC instructions.

Table H-16 System control register support

Register	CRn	opc1	CRm	opc2
System Control Register, SCTLR	c1	0	c0	0
Auxiliary Control Register, ACTLR	c1	0	c0	1

SCTLR is the primary system configuration register in CP15.

c1, System Control Register (SCTLR)

This section describes the implementation of the System Control Register, SCTLR, for ARMv4 and ARMv5. The format of the SCTLR is:

31															16	15	14	13	12	11	10	9	8	7	6	5	4	3	2	1	0
Reserved														L4	RR	V	I	Z	F	R	S	B	L	D	P	W	C	A	M		

Bits [31:16] Reserved.

These reserved bits in the SCTLR are allocated in some circumstances:

- bits [19:16] have been associated with TCM support
- bit [26], described as the L2 bit, has been used to indicate level 2 cache support, see *Level 2 cache support* on page AppxH-51.

These usage models are not compatible with ARMv7.

L4, Bit [15] This bit inhibits ARMv5T Thumb interworking behavior when set. It stops bit [0] updating the CPSR.T bit. Use of the feature is deprecated in ARMv6 and the feature is not supported in ARMv7.

RR, bit [14] Round Robin bit. This bit selects an alternative replacement strategy with a more easily predictable worst-case performance if the cache implementation supports this functionality:

- 0** Normal replacement strategy, for example random replacement
- 1** Predictable strategy, for example round robin replacement.

The replacement strategy associated with each value of the RR bit is IMPLEMENTATION DEFINED.

V, bit [13] Vectors bit. This bit selects the base address of the exception vectors:

- 0** Normal exception vectors, base address 0x00000000
- 1** High exception vectors (Hivecs), base address 0xFFFF0000.

This base address is never remapped.

Support of the V bit is IMPLEMENTATION DEFINED. An implementation can include a configuration input signal that determines the reset value of the V bit. If there is no configuration input signal to determine the reset value of this bit, it resets to 0.

I, bit [12] Instruction cache enable bit. This is a global enable bit for instruction caches:

- 0** Instruction caches disabled
- 1** Instruction caches enabled.

If the system does not implement any instruction caches that can be accessed by the processor at any level of the memory hierarchy, this bit is RAZ/WI.

If the system implements any instruction caches that can be accessed by the processor then it must be possible to disable them by setting this bit to 0.

- Z, bit [11]** Branch prediction enable bit. This bit is used to enable branch prediction, also called program flow prediction:
- 0** program flow prediction disabled
 - 1** program flow prediction enabled.
- If program flow prediction cannot be disabled, this bit is RAO/WI. Program flow prediction includes all possible forms of speculative change of instruction stream prediction. Examples include static prediction, dynamic prediction, and return stacks.
- If the implementation does not support program flow prediction this bit is RAZ/WI.
- F (bit [10])** The meaning of this bit is IMPLEMENTATION DEFINED.
- R (bit [9])** ROM protection bit, supported for backwards compatibility. The effect of this bit is described in Table H-6 on page AppxH-23. Use of this feature is deprecated in ARMv6 and the feature is not supported in ARMv7.
- S (bit [8])** System protection bit, supported for backwards compatibility. The effect of this bit is described in Table H-6 on page AppxH-23. Use of this feature is deprecated in ARMv6 and the feature is not supported in ARMv7.
- B (bit [7])** This bit configures the ARM processor to the endianness of the memory system:
- 0** Little-endian memory system (LE)
 - 1** Big-endian memory system (BE-32).
- ARM processors that support both little-endian and big-endian memory systems use this bit to configure the ARM processor to rename the four byte addresses in a 32-bit word.
- Endian support changed in ARMv6. Use of this feature is deprecated in ARMv6 and the feature is not supported in ARMv7.
- An implementation can include a configuration input signal that determines the reset value of the B bit. If there is no configuration input signal to determine the reset value of this bit then it resets to 0.
- Bits [6:4]** RAO/SBOP.
- W (bit [3])** This is the enable bit for the write buffer:
- 0** Write buffer disabled
 - 1** Write buffer enabled.
- If the write buffer is not implemented, this bit is RAZ/WI. If the write buffer cannot be disabled, this bit is RAO and ignores writes. Use of this feature is deprecated in ARMv6 and the feature is not supported in ARMv7.
- C, bit [2]** Cache enable bit. This is a global enable bit for data and unified caches:
- 0** Data and unified caches disabled
 - 1** Data and unified caches enabled.
- If the system does not implement any data or unified caches that can be accessed by the processor at any level of the memory hierarchy, this bit is RAZ/WI.

If the system implements any data or unified caches that can be accessed by the processor then it must be possible to disable them by setting this bit to 0.

A, bit [1] Alignment bit. This is the enable bit for Alignment fault checking:

0 Alignment fault checking disabled

1 Alignment fault checking enabled.

For more information, see *Alignment* on page AppxH-6.

M, bit [0] Memory control bit. This is a global enable bit to enable an MMU where VMSA is supported, or an MPU where PMSA is supported:

0 memory management (MMU or MPU) disabled

1 memory management (MMU or MPU) enabled.

H.7.5 c2 and c3, VMSA memory protection and control registers

ARMv4 and ARMv5 support a single Translation Table Base Register (TTBR) that is compatible with TTBR0, and the *Domain Access Control Register* (DACR).

The TTBR is as defined for TTBR0 in *CP15 c2, Translation table support registers* on page B3-113 except that:

- The base address bitfield is a fixed-length field, bits [31:14] (N=0)
- Bit [5] is reserved.

The DACR is as defined in *c3, Domain Access Control Register (DACR)* on page B3-119.

H.7.6 c5 and c6, VMSA memory system support

ARMv4 and ARMv5 support a Fault Status Register (FSR) and a Fault Address Register (FAR). These registers are accessed using MCR and MRC instructions. Table H-17 summarizes them.

Table H-17 VMSA fault support

Register	CRn	opc1	CRm	opc2
Fault Status Register, FSR	c5	0	c0	0
Fault Address Register, FAR	c6	0	c0	0

The FSR is updated on Prefetch Abort exceptions and Data Abort exceptions. The FAR is only updated with the MVA on Data Abort exceptions.

H.7.7 c2, c3, c5, and c6, PMSA support

While the general principles for memory protection in ARMv4 and ARMv5 are the same, CP15 support for protected memory is different from the programming model of ARMv6 and ARMv7. Memory regions have configurable base address and size attributes. There are also registers for describing cacheability, bufferability, and access permissions across the regions. For more information, see *Memory model and memory ordering* on page AppxH-10.

ARMv4 and ARMv5 support a fixed number of memory regions, either:

- eight unified memory regions
- eight data and eight instruction regions.

Table H-19 shows the PMSA register support.

Table H-19 PMSA register support

Register	CRn	opc1	CRm	opc2
Data or unified Cacheability Register, DCR	c2	0	c0	0
Instruction Cacheability Register, ICR	c2	0	c0	1
Data or unified Bufferability Register, DBR	c3	0	c0	0
Data or unified Access Permission Register, DAPR	c5	0	c0	0
Instruction Access Permission Register, IAPR	c5	0	c0	1
Data or unified Extended Access Permission Register, DEAPR	c5	0	c0	2
Instruction Extended Access Permission Register, IEAPR	c5	0	c0	3
Data or unified Memory Region Registers, DMRR0-DMRR7	c6	0	c0-c7 ^a	0
Instruction Memory Region Registers, IMRR0-IMRR7	c6	0	c0-c7 ^a	1

a. <CRm> selects the region, for example <CRm> == 6 selects the region register for region 6, DMRR6 or IMRR6.

If an implementation has a single set of protection regions that apply to both instruction and data accesses, only the registers that are accessed using even values of <opc2> exist. Where separate data and instruction regions are supported, with the exception of the extended access permission registers, registers associated with data have <opc2> == 0 and those associated with instructions have <opc2> == 1. All PMSA registers are 32-bit registers and only accessible in privileged modes.

c2, Memory Region Cacheability Registers (DCR and ICR)

The two Memory Region Cacheability Registers are:

- The Data or unified Cacheability Register, DCR.
- The Instruction Cacheability Register, ICR. The ICR is implemented only when the processor implements separate data and instruction memory protection region definitions.

A Memory Region Cacheability Register holds a Cacheability bit, C, for each of the eight memory protection regions.

The format of a Memory Region Cacheability Register is:

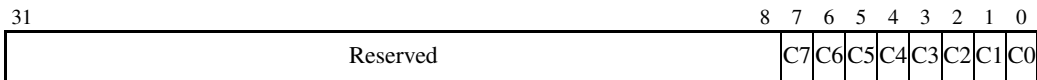

Bits [31:8] Reserved. UNK/SBZP.

Cn, bit [n], for n = 0 to 7

Cacheability bit, C, for memory protection region n.

Accessing the Memory Region Cacheability Registers

To access the Memory Region Cacheability Registers you read or write the CP15 registers with <opc1> set to 0, <CRn> set to c2, <CRm> set to c0, and <opc2> set to:

- 0 for the DCR
- 1 for the IPR.

For example:

```
MRC p15,0,<Rt>,c2,c0,0 ; Read CP15 Data or unified Region Cacheability Register
MCR p15,0,<Rt>,c2,c0,0 ; Write CP15 Data or unified Region Cacheability Register
MRC p15,0,<Rt>,c2,c0,1 ; Read CP15 Instruction Region Cacheability Register
MCR p15,0,<Rt>,c2,c0,1 ; Write CP15 Instruction Region Cacheability Register
```

c3, Memory Region Bufferability Register (DBR)

The Memory Region Bufferability Register, DBR, holds Bufferability bit, B, for each of the eight data or unified memory protection regions.

Only data accesses are bufferable and therefore there is only a single Memory Region Bufferability Register, regardless of whether the implementation has a single set of protection regions, or separate protection region definitions for instruction and data accesses.

The format of the Memory Region Bufferability Register is:

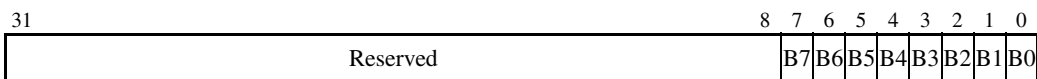

Bits [31:8] Reserved. UNK/SBZP.

Bn, bit [n], for n = 0 to 7

Bufferability bit, B, for memory protection region n.

Accessing the Memory Region Bufferability Register

To access the Memory Region Bufferability Register you read or write the CP15 registers with <opc1> set to 0, <CRn> set to c3, <CRm> set to c0, and <opc2> set to 0. For example:

```
MRC p15,0,<Rt>,c3,c0,0    ; Read  CP15 Data or unified Region Bufferability Register
MCR p15,0,<Rt>,c3,c0,0    ; Write CP15 Data or unified Region Bufferability Register
```

c5, Memory Region Access Permissions Registers (DAPR and IAPR)

The two Memory Region Access Permissions Registers are:

- The Data or unified Access Permissions Register, DAPR.
- The Instruction Access Permissions Register, IAPR. The IAPR is implemented only when the processor implements separate data and instruction memory protection region definitions.

A Memory Region Access Permissions Register hold the access permission bits AP[1:0] for each of the eight memory protection regions.

The format of a Memory Region Access Permissions Register is:

31	16 15 14 13 12 11 10 9 8 7 6 5 4 3 2 1 0
Reserved	AP7 AP6 AP5 AP4 AP3 AP2 AP1 AP0

Bits [31:16] Reserved. UNK/SBZP.

APn, bits [2n+1:2n], for n = 0 to 7

Access permission bits AP[1:0] for memory protection region n.

For details of the significance and encoding of these bits see Table H-10 on page AppxH-29.

If the implementation does not permit the requested type of access, it signals an abort to the processor.

Accessing the Memory Region Access Permissions Registers

To access the Memory Region Access Permissions Registers you read or write the CP15 registers with <opc1> set to 0, <CRn> set to c5, <CRm> set to c0, and <opc2> set as follows:

- 0 if there is only a single set of protection regions
- when there are separate memory protection regions for data and instructions:
 - 0 to access the Data Region Access Permissions Register
 - 1 to access the Instruction Region Access Permissions Register.

For example:

```
MRC p15,0,<Rt>,c5,c0,0    ; Read  CP15 Data or unified Region Access Permissions Register
MCR p15,0,<Rt>,c5,c0,0    ; Write CP15 Data or unified Region Access Permissions Register
```

MRC p15,0,<Rt>,c5,c0,1 ; Read CP15 Instruction Region Access Permissions Register
MCR p15,0,<Rt>,c5,c0,1 ; Write CP15 Instruction Region Access Permissions Register

c5, Memory Region Extended Access Permissions Registers (DEAPR and IEAPR)

The two Memory Region Extended Access Permissions Registers are:

- The Data or unified Extended Access Permissions Register, DEAPR.
- The Instruction Extended Access Permissions Register, IEAPR. The IEAPR is implemented only when the processor implements separate data and instruction memory protection region definitions.

Whether an implementation includes Extended Access Permissions Registers is IMPLEMENTATION DEFINED.

A Memory Region Extended Access Permissions Registers hold the access permission bits AP[3:0] for each of the eight memory protection regions.

The format of a Memory Region Access Permissions Register is:

31	28	27	24	23	20	19	16	15	12	11	8	7	4	3	0
AP7	AP6		AP5		AP4		AP3		AP2		AP1		AP0		

APn, bits [4n+3:4n], for n = 0 to 7

Access permission bits AP[3:0] for memory protection region n.

For details of the significance of these bits see Table H-11 on page AppxH-29.

If the implementation does not permit the requested type of access, it signals an abort to the processor.

Accessing the Memory Region Extended Access Permissions Registers

To access the Memory Region Extended Access Permissions Registers you read or write the CP15 registers with <opc1> set to 0, <CRn> set to c5, <CRm> set to c0, and <opc2> set as follows:

- 2 if there is only a single set of protection regions
- when there are separate memory protection regions for data and instructions:
 - 2 to access the Data Region Extended Access Permissions Register
 - 3 to access the Instruction Region Extended Access Permissions Register.

For example:

MRC p15,0,<Rt>,c5,c0,2 ; Read CP15 Data or unified Region Extended Access Permissions Register
MCR p15,0,<Rt>,c5,c0,2 ; Write CP15 Data or unified Region Extended Access Permissions Register
MRC p15,0,<Rt>,c5,c0,3 ; Read CP15 Instruction Region Extended Access Permissions Register
MCR p15,0,<Rt>,c5,c0,3 ; Write CP15 Instruction Region Extended Access Permissions Register

c6, Memory Region registers (DMRR0-DMRR7 and IMRR0-IMRR7)

The Memory Region registers define the MPU memory regions as follows:

- If an implementation supports only a single set of memory region definitions that apply to both data and instruction accesses, it must provide a single set of eight Data or unified Memory Region Registers, DMRR0-DMRR7.
- If an implementation supports separate memory region definitions for data and instruction accesses, it must provide two sets of eight Memory Region Registers:
 - eight Data or unified Memory Region Registers, DMRR0-DMRR7
 - eight Instruction Memory Region Registers, IMRR0-IMRR7.

Each Memory Region register:

- defines a single memory region by specifying its base address and size
- includes an enable bit for the associated memory region.

The format of a Memory Region register is:

31	12 11	6 5	1 0
Region base address	Reserved	Size	En

Region base address, bits [31:12]

Bits [31:12] of the base address for the region. Bits [11:0] of the address must be zero. Therefore, the smallest region that can be defined is 4KB. Regions must be aligned appropriately, and so for regions larger than 4KB the least significant bits of this field must be zero. For more information, see the description of the Size field.

Bits [11:6] Reserved. UNK/SBZP.

Size, bits [5:1]

Encodes the size of the region. Table H-20 shows the permitted encodings for this field.

Table H-20 MPU Region size encoding

Encoding	Region size	Base address constraints
0b01011	4KB	None
0b01100	8KB	Register bit [12] must be zero
0b01101	16KB	Register bits [13:12] must be zero
0b01110	32KB	Register bits [14:12] must be zero
0b01111	64KB	Register bits [15:12] must be zero
0b10000	128KB	Register bits [16:12] must be zero
0b10001	256KB	Register bits [17:12] must be zero

Table H-20 MPU Region size encoding (continued)

Encoding	Region size	Base address constraints
0b10010	512KB	Register bits [18:12] must be zero
0b10011	1MB	Register bits [19:12] must be zero
0b10100	2MB	Register bit [20:12] must be zero
0b10101	4MB	Register bits [21:12] must be zero
0b10110	8MB	Register bits [22:12] must be zero
0b10111	16MB	Register bits [23:12] must be zero
0b11000	32MB	Register bits [24:12] must be zero
0b11001	64MB	Register bits [25:12] must be zero
0b11010	128MB	Register bits [26:12] must be zero
0b11011	256MB	Register bits [27:12] must be zero
0b11100	512MB	Register bits [28:12] must be zero
0b11101	1G	Register bits [29:12] must be zero
0b11110	2GB	Register bits [30:12] must be zero
0b11111	4GB	Register bits [31:12] must be zero

Encodings not shown in the table are reserved. The effect of using a reserved value in this field is UNPREDICTABLE.

En, bit [0] Enable bit for the region:
0 Region is disabled
1 Region is enabled.

This field resets to zero. Therefore all MPU regions are disabled on reset.

The base address constraints given in Table H-20 on page AppxH-47 ensure that the specified region is correctly aligned in memory, so that its alignment is a multiple of the region size. If a base address is entered that does not follow these alignment constraints, behavior is UNPREDICTABLE.

Accessing the Region Access Permissions registers

To access the Region Access Permissions registers you read or write the CP15 registers with <opc1> set to 0, <CRn> set to c5, and:

- <CRm> set to indicate the region number, from <CRm> == c0 for memory region 0, to <CRm> == c7 for memory region 7

- <opc2> set to:
 - 0 if there is only a single set of protection region definitions
 - 0 to access the Data Region Access Permissions Register when the data and instruction memory regions are defined separately
 - 1 to access the Instruction Region Access Permissions Register when the data and instruction memory regions are defined separately.

For example:

```
MRC p15,0,<Rt>,c6,c0,0 ; Read CP15 Data or unified Region Register, Region 0
MCR p15,0,<Rt>,c6,c0,0 ; Write CP15 Data or unified Region Register, Region 0
MRC p15,0,<Rt>,c6,c1,0 ; Read CP15 Data or unified Region Register, Region 1
MCR p15,0,<Rt>,c6,c1,0 ; Write CP15 Data or unified Region Register, Region 1
MRC p15,0,<Rt>,c6,c2,1 ; Read CP15 Instruction Memory Region Register, Region 2
MCR p15,0,<Rt>,c6,c2,1 ; Write CP15 Instruction Memory Region Register, Region 2
```

H.7.8 c7, Cache operations

Table H-21 shows the cache operation provision in ARMv4 and ARMv5. All cache operations are performed as MCR instructions and only operate on a level 1 cache associated with a specific processor. The equivalent operations in ARMv7 operate on multiple levels of cache. See *CP15 c7, Cache and branch predictor maintenance functions* on page B3-126.

Table H-21 Cache operation support

Operation	CRn	opc1	CRm	opc2
Invalidate instruction cache ^a	c7	0	c5	0
Invalidate instruction cache line by MVA ^a	c7	0	c5	1
Invalidate instruction cache line by set/way	c7	0	c5	2
Flush entire branch predictor array ^a	c7	0	c5	6
Flush branch predictor array entry by MVA ^a	c7	0	c5	7
Invalidate data cache	c7	0	c6	0
Invalidate data cache line by MVA ^a	c7	0	c6	1
Invalidate data cache line by set/way ^a	c7	0	c6	2
Invalidate unified cache, or instruction cache and data cache	c7	0	c7	0
Invalidate unified cache line by MVA	c7	0	c7	1
Invalidate unified cache line by set/way	c7	0	c7	2
Clean data cache line by MVA ^a	c7	0	c10	1

Table H-21 Cache operation support (continued)

Operation	CRn	opc1	CRm	opc2
Clean data cache line by set/way ^a	c7	0	c10	2
Clean entire unified cache	c7	0	c11	0
Clean unified cache line by MVA ^a	c7	0	c11	1
Clean unified cache line by set/way	c7	0	c11	2
Prefetch instruction cache line by MVA ^b	c7	0	c13	1
Clean and Invalidate data cache line by MVA ^a	c7	0	c14	1
Clean and Invalidate data cache line by set/way ^a	c7	0	c14	2
Clean and Invalidate unified cache line by MVA	c7	0	c15	1
Clean and Invalidate unified cache line by set/way	c7	0	c15	2
Test and Clean data cache	c7	0	c10	3
Test and Clean and Invalidate data cache	c7	0	c14	3

- a. These are the only cache operations available in ARMv7. The corresponding ARMv7 operations are multi-level operations, and the data cache operations are defined as data or unified cache operations.
- b. Used with TLB lockdown. See *TLB lockdown procedure, using the by entry model* on page AppxH-61.

Test and clean operations

This scheme provides an efficient way to clean, or clean and invalidate, a complete data cache by executing an MRC instruction with the condition code flags as the destination. A global cache dirty status bit is written to the Z flag. How many lines are tested in each iteration of the instruction is IMPLEMENTATION DEFINED.

To clean an entire data cache with this method the following code loop can be used:

```
tc_loop  MRC p15, 0, APSR_nzcv, c7, c10, 3      ; test and clean
         BNE tc_loop
```

To clean and invalidate an entire data cache with this method, the following code loop can be used:

```
tci_loop MRC p15, 0, APSR_nzcv, c7, c14, 3      ; test, clean and invalidate
         BNE tci_loop
```

Level 2 cache support

The recommended method for adding closely coupled level 2 cache support from ARMv5TE is to define equivalent operations to the level 1 support with `<opc1> == 1` in the appropriate MCR instructions. The operations in Table H-21 on page AppxH-49 that are supported are IMPLEMENTATION DEFINED.

H.7.9 c7, Miscellaneous functions

The Wait For Interrupt operation is used in some implementations as part of a power management support scheme. The operation is deprecated in ARMv6 and not supported in ARMv7 (it behaves as a NOP instruction).

Barrier operations are used for system correctness to ensure visibility of memory accesses to other agents in a system. For ARMv4 and ARMv5 the requirement for and use of barrier operations is IMPLEMENTATION DEFINED. Barrier functionality is formally defined as part of the memory architecture enhancements introduced in ARMv6.

Table H-22 summarizes the MCR instruction encoding details.

Table H-22 Memory barrier register support

Operation	CRn	opc1	CRm	opc2
<i>Wait For Interrupt</i> (CP15WFI)	c7	0	c0	4
<i>Instruction Synchronization Barrier</i> (CP15ISB) ^a	c7	0	c5	4
<i>Data Synchronization Barrier</i> (CP15DSB) ^b	c7	0	c10	4
<i>Data Memory Barrier</i> (CP15DMB)	c7	0	c10	5

a. This operation was previously known as *Prefetch Flush* (PF or PFF).

b. This operation was previously known as *Data Write Barrier* or *Drain Write Buffer* (DWB).

H.7.10 c8, VMSA TLB support

Table H-23 illustrates TLB operation provision in ARMv4 and ARMv5. All TLB operations are performed as MCR instructions and are a subset of the operations available in ARMv7. See *CP15 c8, TLB maintenance operations* on page B3-138.

Table H-23 TLB operation support

Operation	CRn	opc1	CRm	opc2
Invalidate Instruction TLB	c8	0	c5	0
Invalidate Instruction TLB Entry (by MVA)	c8	0	c5	1
Invalidate Data TLB	c8	0	c6	0

Table H-23 TLB operation support (continued)

Operation	CRn	opc1	CRm	opc2
Invalidate Data TLB Entry (by MVA)	c8	0	c6	1
Invalidate Unified TLB	c8	0	c7	0
Invalidate Unified TLB Entry (by MVA)	c8	0	c7	1

H.7.11 c9, cache lockdown support

One problem with caches is that although they normally improve average access time to data and instructions, they usually increase the worst-case access time. This is because:

- There is a delay before the system determines that a cache miss has occurred and starts the main memory access.
- If a Write-Back cache is being used, there might be more delay because of the requirement to store the contents of the cache line that is being reallocated.
- A whole cache line is loaded from main memory, not only the data requested by the ARM processor.

In real-time applications, this increase in the worst-case access time can be significant.

Cache lockdown is an optional feature designed to alleviate this. It enables critical code and data, for example high priority interrupt routines and the data they access, to be loaded into the cache in such a way that the cache lines containing them are not subsequently reallocated. This ensures that all subsequent accesses to this code and data are cache hits and therefore complete as quickly as possible.

The ARM architecture specifies four formats for the cache lockdown mechanism. These are known as Format A, Format B, Format C, and Format D. The Cache Type Register contains information on the lockdown mechanism adopted. See *c0, Cache Type Register (CTR)* on page AppxH-35.

Formats A, B, and C all operate on cache ways. Format D is a cache entry locking mechanism. Table H-24 summarizes the CP15 provisions for format A, B, C, and D lockdown mechanisms.

From ARMv7, cache lockdown is IMPLEMENTATION DEFINED with no recommended formats or mechanisms on how it is achieved other than reserved CP15 register space. See *Cache lockdown* on page B2-8 and *CP15 c9, Cache and TCM lockdown registers and performance monitors* on page B3-141.

Table H-24 cache lockdown register support

Register or operation	Lockdown formats	CRn	opc1	CRm	opc2
Data or unified Cache Lockdown Register, DCLR	A, B, and C	c9	0	c0	0
Instruction Cache Lockdown Register, ICLR	A, B, and C	c9	0	c0	1
Fetch and lock instruction cache line	D	c9	0	c5	0

Table H-24 cache lockdown register support (continued)

Register or operation	Lockdown formats	CRn	opc1	CRm	opc2
Unlock instruction cache	D	c9	0	c5	1
Format D Data or unified Cache Lockdown Register, DCLR2	D	c9	0	c6	0
Unlock data cache	D	c9	0	c6	1

General conditions applying to Format A, B, and C lockdown

The instructions used to access the CP15 c9 lockdown registers are as follows:

```
MCR p15, 0, <Rt>, c9, c0, 0 ; write Data or unified Cache Lockdown Register
MRC p15, 0, <Rt>, c9, c0, 0 ; read Data or unified Cache Lockdown Register
MCR p15, 0, <Rt>, c9, c0, 1 ; write Instruction Cache Lockdown Register
MRC p15, 0, <Rt>, c9, c0, 1 ; read Instruction Cache Lockdown Register
```

Formats A, B, and C all use cache ways for lockdown granularity. Granularity is defined by the *lockdown block*, and a cache locking scheme can use any number of lockdown blocks from 1 to (ASSOCIATIVITY-1).

If N lockdown blocks are locked down, they have indices 0 to N-1, and lockdown blocks N to (ASSOCIATIVITY-1) are available for normal cache operation.

A cache way based lockdown implementation must not lock down the entire cache. At least one cache way must be left for normal cache operation, otherwise behavior is UNPREDICTABLE.

The lockdown blocks are indexed from 0 to (ASSOCIATIVITY-1). The cache lines in a lockdown block are chosen to have the same WAY number as the lockdown block index value. So lockdown block n consists of the cache line with index n from each cache set, and n takes the values from n == 0 to n == (ASSOCIATIVITY-1).

Where NSETS is the number of sets, and LINELEN is the cache line length, each lockdown block can hold NSETS memory cache lines, provided each of the memory cache lines is associated with a different cache set. ARM recommends that systems are designed so that each lockdown block contains a set of NSETS consecutive memory cache lines. This is NSETS × LINELEN consecutive memory locations, starting at a cache line boundary. Such sets are easily identified and are guaranteed to consist of one cache line associated with each cache set.

Formats A and B lockdown

Formats A and B use a WAY field that is chosen to be wide enough to hold the way number of any lockdown block. Its width, W, is given by $W = \log_2(\text{ASSOCIATIVITY})$, rounded up to the nearest integer if necessary.

The format of a Format A lockdown register is:

31	32-W	31-W	0
WAY		UNK/SBZ	

Reading a Format A register returns the value last written to it.

Writing a Format A register has the following effects:

- The next cache miss in each cache set replaces the cache line with the specified WAY in that cache set.
- The replacement strategy for the cache is constrained so that it can only select cache lines with the specified WAY and higher until the register is written again.

The format of a Format B lockdown register is:

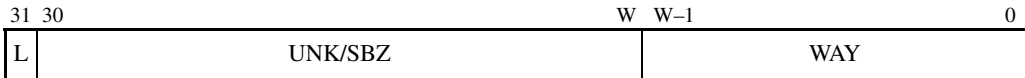

Reading a Format B register returns the value last written to it.

Writing a Format B register has the following effects:

- If $L == 1$, all cache misses replace the cache line with the specified WAY in the relevant cache set until the register is written again.
- If $L == 0$:
 - If the previous value of L was 0, and the previous value of WAY is smaller than the new value, the behavior is UNPREDICTABLE.
 - If the previous value of L was not 0, the replacement strategy for the cache is constrained so that it can only select cache lines with the specified WAY and higher until the register is written again.

Format A and B cache lockdown procedure

The procedure for locking down N lockdown blocks is as follows:

1. Ensure that no processor exceptions can occur during the execution of this procedure, for example by disabling interrupts. If for some reason this is not possible, all code and data used by any exception handlers that can get called must be treated as code and data used by this procedure for the purpose of steps 2 and 3.
2. If an instruction cache or a unified cache is being locked down, ensure that all the code executed by this procedure is in a Non-cacheable area of memory.
3. If a data cache or a unified cache is being locked down, ensure that all data used by the following code is in a Non-cacheable area of memory, apart from the data that is to be locked down.
4. Ensure that the data or instructions that are to be locked down are in a Cacheable area of memory.
5. Ensure that the data or instructions that are to be locked down are not already in the cache, using cache clean, invalidate, or clean and invalidate instructions as appropriate.
6. For each value of i from 0 to $N-1$:
 - a. Write to the CP15 c9 register with:
 - $WAY == i$, for Formats A and B
 - $L == 1$, for Format B only.
 - b. For each of the cache lines to be locked down in lockdown block i :

If a data cache or a unified cache is being locked down, use an LDR instruction to load a word from the memory cache line. This ensures that the memory cache line is loaded into the cache. If an instruction cache is being locked down, use the CP15 c7 prefetch instruction cache line operation to fetch the memory cache line into the cache.

7. Write to the CP15 c9 register with:
 - WAY == N, for Formats A and B
 - L == 0, for Format B only.

Note

If the FCSE described in Appendix E *Fast Context Switch Extension (FCSE)* is being used, care must be taken in step 6b because:

- If a data cache or a unified cache is being locked down, the address used for the LDR instruction is subject to modification by the FCSE.
- If an instruction cache is being locked down, the address used for the CP15 c7 operation is treated as data and so is not subject to modification by the FCSE.

To minimize the possible confusion caused by this, ARM recommends that the lockdown procedure:

- starts by disabling the FCSE (by setting the PID to zero)
 - where appropriate, generates modified virtual addresses itself by ORing the appropriate PID value into the top seven bits of the virtual addresses it uses.
-

Format A and B cache unlock procedure

To unlock the locked down portion of the cache, write to the CP15 c9 register with:

- WAY == 0, for Formats A and B
- L == 0, for Format B only.

Format C lockdown

Cache lockdown Format C is a different form of cache way based locking. It enables the allocation to each cache way to be disabled or enabled. This provides some additional control over the cache pollution caused by particular applications, in addition to a traditional lockdown function for locking critical regions into the cache.

A locking bit for each cache way determines whether the normal cache allocation mechanisms can access that cache way.

For caches of higher associativity, only cache ways 0 to 31 can be locked.

A maximum of N-1 ways of an N-way cache can be locked. This ensures that a normal cache line replacement can be performed. Handling a cache miss is UNPREDICTABLE if there are no cache ways that have L==0.

The 32 bits of the lockdown register determine the L bit for the associated cache way. The value of <opc2> determines whether the instruction lockdown register or data lockdown register is accessed.

The cache lockdown register is normally modified in a read, modify, write sequence. For example, the following sequence sets the L bit to 1 for way 0 of the instruction cache:

```
; In the following code, <Rn> can be any register whose value does not need to be kept.
MRC    p15, 0, <Rn>, c9, c0, 1
ORR    <Rn>, <Rn>, #0x01
MCR    p15, 0, <Rn>, c9, c0, 1      ; Set way 0 L bit for the instruction cache
```

The format of the Format C lockdown register is:

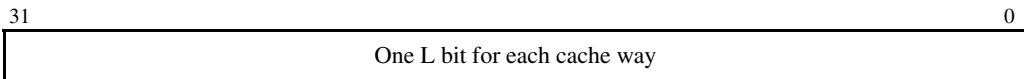

Bits [31:0] The L bits for each cache way. If a cache way is not implemented, the L bit for that way is RAO/WI. Each bit relates to its corresponding cache way, that is bit N refers to way N.

- | | |
|----------|---|
| 0 | Allocation to the cache way is determined by the standard replacement algorithm (reset state) |
| 1 | No Allocation is performed to this cache way. |

The Format C lockdown register must only be changed when it is certain that all outstanding accesses that can cause a cache linefill have completed. For this reason, a Data Synchronization Barrier instruction must be executed before the lockdown register is changed.

Format C cache lock procedure

The procedure for locking down into a cache way *i* with *N* cache ways using Format C involves making it impossible to allocate to any cache way other than the target cache way *i*. The architecture defines the following method for locking data into the caches:

1. Ensure that no processor exceptions can occur during the execution of this procedure, for example by disabling interrupts. If for some reason this is not possible, all code and data used by any exception handlers that can get called must be treated as code and data used by this procedure for the purpose of steps 2 and 3.
2. If an instruction cache or a unified cache is being locked down, ensure that all the code executed by this procedure is in an Non-cacheable area of memory, including the Tightly Coupled Memory, or in an already locked cache way.
3. If a data cache or a unified cache is being locked down, ensure that all data used by the following code (apart from the data that is to be locked down) is in an Non-cacheable area of memory, including the Tightly Coupled Memory, or is in an already locked cache way.
4. Ensure that the data or instructions that are to be locked down are in a Cacheable area of memory.
5. Ensure that the data or instructions that are to be locked down are not already in the cache, using cache clean, invalidate, or clean and invalidate instructions as appropriate.

6. Write to the CP15 c9 register with CRm == 0, setting L=0 for bit i and L=1 for all other bits. This enables allocation to the target cache way i.
7. For each of the cache lines to be locked down in cache way i:
 - If a data cache or a unified cache is being locked down, use an LDR instruction to load a word from the memory cache line. This ensures that the memory cache line is loaded into the cache.
 - If an instruction cache is being locked down, use the CP15 c7 prefetch instruction cache line operation to fetch the memory cache line into the cache.
8. Write to the CP15 c9 register with CRm == 0, setting L = 1 for bit i and restoring all the other bits to the values they had before this routine was started.

Format C cache unlock procedure

To unlock the locked down portion of the cache, write to the CP15 c9 register, setting L == 0 for each bit.

Format D lockdown

This format locks individual L1 cache line entries rather than using a cache way scheme. The methods differ for the instruction and data caches.

The instructions used to access the CP15 c9 Format D Cache Lockdown Registers and operations are as follows:

```

MCR p15, 0, <Rt>, c9, c5, 0    ; fetch and lock instruction cache line,
                                ; Rt = MVA
MCR p15, 0, <Rt>, c9, c5, 1    ; unlock instruction cache,
                                ; Rt ignored
MCR p15, 0, <Rt>, c9, c6, 0    ; write Format D Data Cache Lockdown Register,
                                ; Rt = set or clear lockdown mode
MCR p15, 0, <Rt>, c9, c6, 0    ; read Format D Data Cache Lockdown Register,
                                ; Rt = lockdown mode status
MCR p15, 0, <Rt>, c9, c6, 1    ; unlock data cache,
                                ; Rt ignored

```

————— Note —————

Some format D implementations use CRm == {c1, c2} instead of CRm == {c5, c6}. You must check the Technical Reference Manual to find the encoding uses. The architecture did not require the implementation of CP15, and the Architecture Reference Manual only gave a recommended implementation. The actual CP15 implementation is IMPLEMENTATION DEFINED in ARMv4 and ARMv5.

The following rules determine how many entries in a cache set can be locked:

- At least one entry per cache set must be left for normal cache operation, otherwise behavior is UNPREDICTABLE.
- How many ways in each cache set can be locked is IMPLEMENTATION DEFINED.
MAX_CACHESSET_ENTRIES_LOCKED < NWAYS.

- Whether attempts to lock additional entries in Format D are allocated as an unlocked entry or ignored is IMPLEMENTATION DEFINED.

For the instruction cache, a fetch and lock operation fetches and locks individual cache lines. Each cache line is specified by its MVA. To lock code into the instruction cache, the following rules apply:

- The routine used to lock lines into the instruction cache must be executed from Non-cacheable memory.
- The code being locked into the instruction cache must be Cacheable.
- The instruction cache must be enabled and invalidated before locking down cache lines.

If these rules are not applied, results are UNPREDICTABLE. Entries must be unlocked using the global instruction cache unlock command.

Cache lines must be locked into the data cache by first setting a global lock control bit. Data cache linefills occurring while the global lock control bit is set are locked into the data cache. To lock data into the data cache, the following rules apply:

- The data being locked must not exist in the cache. Cache clean and invalidate operations might be necessary to meet this condition.
- The data to be locked must be Cacheable.
- The data cache must be enabled.

c9, Format D Data or unified Cache Lockdown Register, DCLR2

The format of the format D Data or unified Cache Lockdown Register is:

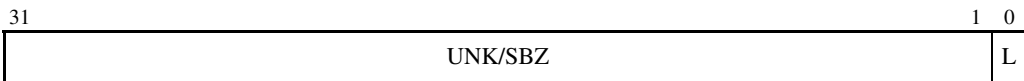

- L (bit [0])** Lock bit
- 0** no locking occurs
 - 1** all data fills are locked while this bit is set.

Interaction with CP15 c7 operations

Cache lockdown only prevents the normal replacement strategy used on cache misses choosing to reallocate cache lines in the locked down region. CP15 c7 operations that invalidate, clean, or clean and invalidate cache contents affect locked down cache lines as normal. If invalidate operations are used, you must ensure that they do not use virtual addresses or cache set/way combinations that affect the locked down cache lines. Otherwise, if it is difficult to avoid affecting the locked down cache lines, repeat the cache lockdown procedure afterwards.

H.7.12 c9, TCM support

TCM register support is optional when CP15 and TCM are supported in ARMv4 and ARMv5. For details see *c9, TCM support* on page AppxG-46.

H.7.13 c10, VMSA TLB lockdown support

TLB lockdown is an optional feature that enables the results of specified translation table walks to load into the TLB in a way that prevents them being overwritten by the results of subsequent translation table walks.

Translation table walks can take a long time because they involve potentially slow main memory accesses. In real-time interrupt handlers, translation table walks caused by the TLB that do not contain translations for the handler or the data it accesses can increase interrupt latency significantly.

Two basic lockdown models are supported:

- a TLB lock by entry model
- a translate and lock model introduced as an alternative model in ARMv5TE.

In an ARMv6 implementation that includes the Security Extensions, c10 TLB Lockdown registers are Configurable access registers, with access controlled by the NSACR. For more information, see:

- *Configurable access CP15 registers* on page B3-74 for general information
- *c1, Non-Secure Access Control Register (NSACR)* on page B3-110 and *c1, VMSA Security Extensions support* on page AppxG-35 for details of the NSACR.

From ARMv7, TLB lockdown is IMPLEMENTATION DEFINED with no recommended formats or mechanisms on how it is achieved other than reserved CP15 register space. See *TLB lockdown* on page B3-56 and *CP15 c10, Memory remapping and TLB control registers* on page B3-142.

Table H-25 shows the TLB operations used to support the different mechanisms.

Table H-25 TLB lockdown register support

Register or operation	Mechanism	CRn	opc1	CRm	opc2
Data or unified TLB Lockdown Register, DTLBLR	By entry	c10	0	c0 ^a	0
Instruction TLB Lockdown Register, ITLBLR	By entry	c10	0	c0 ^a	1
Lock instruction TLB	Translate and lock	c10	0	c4 ^b	0
Unlock instruction TLB	Translate and lock	c10	0	c4 ^b	1
Lock data TLB	Translate and lock	c10	0	c8 ^b	0
Unlock data TLB	Translate and lock	c10	0	c8 ^b	1

a. Read/write register that can be accessed using MCR and MRC instructions.

b. Write-only operation that is accessed only using the MCR instruction.

The TLB lock by entry model

When a new entry is written to the TLB as the result of a translation table walk following a TLB miss, the Victim field of the appropriate TLB Lockdown Register is incremented. When the value of the Victim field reaches the maximum number of TLB entries, the incremented Victim field wraps to the value of the Base field.

The architecture permits a modified form of this where the Base field is fixed as zero. It is particularly appropriate where an implementation provides dedicated lockable entries (unified or Harvard) as a separate resource from the general TLB provision. To determine which form of the locking model is provided, write the Base field with all bits nonzero, read it back and check whether it is a nonzero value.

TLB Lockdown Register format, for the lockdown by entry mechanism

The format of the CP15 register used for the lockdown by entry form is:

31	32-W ^a	31-W	32-2W	31-2W	1	0
Base		Victim		Reserved		P

a. $W = \log_2(n)$, rounded up to an integer if necessary, where n is the number of TLB entries.

If the implementation has separate instruction and data TLBs, there are two variants of this register, selected by the <opc2> field of the MCR or MRC instruction used to access the CP15 c10 register:

<opc2> == 0 Selects the data TLB lockdown register.

<opc2> == 1 Selects the instruction TLB lockdown register.

If the implementation has a unified TLB, only one variant of this register exists, and <opc2> must be zero.

CRm must be c0 for MCR and MRC instructions that access the CP15 c10 register.

Writing the appropriate TLB lockdown by entry register has the following effects:

- The victim field specifies which TLB entry is replaced by the translation table walk result generated by the next TLB miss.
- The Base field constrains the TLB replacement strategy to only use the TLB entries numbered from (Base) to ((number of TLB entries)-1), provided the victim field is already in that range.
- Any translation table walk results written to TLB entries while $P == 1$ are protected from being invalidated by the CP15 c8 invalidate entire TLB operations. Ones written while $P == 0$ are invalidated normally by these operations.

Note

If the number of TLB entries is not a power of two, writing a value to either the Base or Victim fields that is greater than or equal to the number of TLB entries has UNPREDICTABLE results.

Reading the appropriate TLB lockdown by entry register returns the last values written to the Base field and the P bit, and the number of the next TLB entry to be replaced in the victim field.

TLB lockdown procedure, using the by entry model

The normal procedure for locking down N TLB entries where the Base field can be modified is as follows:

1. Ensure that no processor exceptions can occur during the execution of this procedure, for example by disabling interrupts.
2. If an instruction TLB or unified TLB is being locked down, write the appropriate version of register c10 with Base == N, Victim == N, and P == 0. If appropriate, turn off facilities like branch prediction that make instruction prefetching harder to understand.
3. Invalidate the entire TLB to be locked down.
4. If an instruction TLB is being locked down, ensure that all TLB entries are loaded that relate to any instruction that could be prefetched by the rest of the lockdown procedure. Provided care is taken about where the lockdown procedure starts, one TLB entry can usually cover all of these. This means that the first instruction prefetch after the TLB is invalidated can do this job.

If a data TLB is being locked down, ensure that all TLB entries are loaded that relate to any data accessed by the rest of the lockdown procedure, including any inline literals used by its code. Usually the best way to do this is to avoid using inline literals in the lockdown procedure, and to put all other data used by it in an area covered by a single TLB entry, and then to load one data item.

If a unified TLB is being locked down, do both of the above.

5. For each of value of i from 0 to N-1:
 - a. Write to the CP15 c10 register with Base == i, Victim == i, and P == 1.
 - b. Force a translation table walk to occur for the area of memory whose translation table walk result is to be locked into TLB entry i as follows:
 - If a data TLB or unified TLB is being locked down, load an item of data from the area of memory.
 - If an instruction TLB is being locked down, use the CP15 c7 prefetch instruction cache line operation defined in Table H-21 on page AppxH-49 to prefetch an instruction from the area of memory.
6. Write to the CP15 c10 register with Base == N, Victim == N, and P == 0.

———— **Note** —————

If the FCSE is being used, care is required in step 5b because:

- If a data TLB or a unified TLB is being locked down, the address used for the load instruction is subject to modification by the FCSE.
- If an instruction TLB is being locked down, the address used for the CP15 c7 operation is being treated as data and so is not subject to modification by the FCSE.

To minimize the possible confusion caused by this, ARM recommends that the lockdown procedure:

- starts by disabling the FCSE, by setting the PID to zero

- where appropriate, generates modified virtual addresses itself by ORing the appropriate PID value into the top 7 bits of the virtual addresses it uses.

Where the Base field is fixed at zero, the algorithm can be simplified as follows:

1. Ensure that no processor exceptions can occur during the execution of this procedure, for example by disabling interrupts.
2. If any current locked entries must be removed, an appropriate sequence of invalidate single entry operations is required.
3. Turn off branch prediction.
4. If an instruction TLB is being locked down, ensure that all TLB entries are loaded that relate to any instruction that could be prefetched by the rest of the lockdown procedure. Provided care is taken about where the lockdown procedure starts, one TLB entry can usually cover all of these. This means that the first instruction prefetch after the TLB is invalidated can do this job.

If a data TLB is being locked down, ensure that all TLB entries are loaded that relate to any data accessed by the rest of the lockdown procedure, including any inline literals used by its code. Usually the best way to do this is to avoid using inline literals in the lockdown procedure, and to put all other data used by it in an area covered by a single TLB entry, and then to load one data item.

If a unified TLB is being locked down, do both of the above.

5. For each value of i from 0 to $N-1$:
 - a. Write to the CP15 c10 register with Base == 0, Victim == i , and P == 1.
 - b. Force a translation table walk to occur for the area of memory whose translation table walk result is to be locked into TLB entry i as follows:
 - If a data TLB or unified TLB is being locked down, load an item of data from the area of memory.
 - If an instruction TLB is being locked down, use the CP15 c7 prefetch instruction cache line operation defined in Table H-21 on page AppxH-49 to cause an instruction to be prefetched from the area of memory.
6. Clear the appropriate lockdown register.

TLB unlock procedure, using the by entry model

To unlock the locked down portion of the TLB after it has been locked down using the above procedure:

1. Use CP15 c8 operations to invalidate each single entry that was locked down.
2. Write to the CP15 c10 register with Base == 0, Victim == 0, and P == 0.

Note

Step 1 ensures that P == 1 entries are not left in the TLB. If they are left in the TLB, the entire TLB invalidation step of a subsequent TLB lockdown procedure does not have the required effect.

The translate and lock model

This mechanism uses explicit TLB operations to translate and lock specific addresses into the TLB. Entries are unlocked on a global basis using the unlock operations. Addresses are loaded using their MVA. The following actions are UNPREDICTABLE:

- accessing these functions with read (MRC) commands
- using functions when the MMU is disabled
- trying to translate and lock an address that is already present in the TLB.

Any abort generated during the translation is reported as a lock abort in the FSR. Only external aborts and Translation faults are guaranteed to be detected. Any access permission, domain, or alignment checks on these functions are IMPLEMENTATION DEFINED. Operations that generate an abort do not affect the target TLB.

Where this model is applied to a unified TLB, the data TLB operations must be used.

Invalidate_all (I,D, or I and D) operations have no effect on locked entries.

TLB lockdown procedure, using the translate and lock model

All previously locked entries can be unlocked by issuing the appropriate unlock operation, I or D side. Explicit lockdown operations are then issued with the required MVA in register Rt.

TLB unlock procedure, using the translate and lock model

Issuing the appropriate unlock (I or D) TLB operation unlocks all locked entries. It is IMPLEMENTATION DEFINED whether an invalidate by MVA TLB operation removes the lock condition.

———— **Note** —————

The invalidate behavior is different in the TLB locking by entry model, where the invalidate by MVA operation is guaranteed to occur.

H.7.14 **c13, VMSA FCSE support**

The FCSE described in Appendix E *Fast Context Switch Extension (FCSE)* is an IMPLEMENTATION DEFINED option in ARMv4 and ARMv5. The feature is supported by the FCSEIDR as described in *c13, FCSE Process ID Register (FCSEIDR)* on page B3-152. The Context ID and Software Thread ID registers listed for ARMv7 are not supported in ARMv4 and ARMv5.

H.7.15 **c15, IMPLEMENTATION DEFINED**

CP15 c15 is reserved for IMPLEMENTATION DEFINED use. It is typically used for processor-specific runtime and test features.

Appendix I

Pseudocode Definition

This appendix provides a definition of the pseudocode used in this manual, and lists the *helper* procedures and functions used by pseudocode to perform useful architecture-specific jobs. It contains the following sections:

- *Instruction encoding diagrams and pseudocode* on page AppxI-2
- *Limitations of pseudocode* on page AppxI-4
- *Data types* on page AppxI-5
- *Expressions* on page AppxI-9
- *Operators and built-in functions* on page AppxI-11
- *Statements and program structure* on page AppxI-17
- *Miscellaneous helper procedures and functions* on page AppxI-22.

Note

The pseudocode in this manual describes ARMv7. Where it can reasonably also describe the differences in earlier versions of the architecture, it does so. However, it does not always do so. For details of the differences in earlier architectures, see Appendix G *ARMv6 Differences* and Appendix H *ARMv4 and ARMv5 Differences*.

I.1 Instruction encoding diagrams and pseudocode

Instruction descriptions in this manual contain:

- An Encoding section, containing one or more encoding diagrams, each followed by some encoding-specific pseudocode that translates the fields of the encoding into inputs for the common pseudocode of the instruction, and picks out any encoding-specific special cases.
- An Operation section, containing common pseudocode that applies to all of the encodings being described. The Operation section pseudocode contains a call to the `EncodingSpecificOperations()` function, either at its start or after only a condition check performed by `if ConditionPassed() then`.

An encoding diagram specifies each bit of the instruction as one of the following:

- An obligatory 0 or 1, represented in the diagram as 0 or 1. If this bit does not have this value, the encoding corresponds to a different instruction.
- A *should be* 0 or 1, represented in the diagram as (0) or (1). If this bit does not have this value, the instruction is UNPREDICTABLE.
- A named single bit or a bit in a named multi-bit field. The `cond` field in bits [31:28] of many ARM instructions has some special rules associated with it.

An encoding diagram matches an instruction if all obligatory bits are identical in the encoding diagram and the instruction, and one of the following is true:

- the encoding diagram is not for an ARM instruction
- the encoding diagram is for an ARM instruction that does not have a `cond` field in bits [31:28]
- the encoding diagram is for an ARM instruction that has a `cond` field in bits [31:28], and bits [31:28] of the instruction are not 0b1111.

The execution model for an instruction is:

1. Find all encoding diagrams that match the instruction. It is possible that no encoding diagrams match. In that case, abandon this execution model and consult the relevant instruction set chapter instead to find out how the instruction is to be treated. The bit pattern of such an instruction is usually reserved and UNDEFINED, though there are some other possibilities. For example, unallocated hint instructions are documented as being reserved and to be executed as NOPs.
2. If the operation pseudocode for the matching encoding diagrams starts with a condition check, perform that condition check. If the condition check fails, abandon this execution model and treat the instruction as a NOP. If there are multiple matching encoding diagrams, either all or none of their corresponding pieces of common pseudocode start with a condition check.
3. Perform the encoding-specific pseudocode for each of the matching encoding diagrams independently and in parallel. Each such piece of encoding-specific pseudocode starts with a bitstring variable for each named bit or multi-bit field in its corresponding encoding diagram, named the same as the bit or multi-bit field and initialized with the values of the corresponding bit(s) from the bit pattern of the instruction.

In a few cases, the encoding diagram contains more than one bit or field with same name. In these cases, the values of all of those bits or fields must be identical. The encoding-specific pseudocode contains a special case using the `Consistent()` function to specify what happens if they are not identical. `Consistent()` returns `TRUE` if all instruction bits or fields with the same name as its argument have the same value, and `FALSE` otherwise.

If there are multiple matching encoding diagrams, all but one of the corresponding pieces of pseudocode must contain a special case that indicates that it does not apply. Discard the results of all such pieces of pseudocode and their corresponding encoding diagrams.

There is now one remaining piece of pseudocode and its corresponding encoding diagram left to consider. This pseudocode might also contain a special case, most commonly one indicating that it is `UNPREDICTABLE`. If so, abandon this execution model and treat the instruction according to the special case.

4. Check the *should be* bits of the encoding diagram against the corresponding bits of the bit pattern of the instruction. If any of them do not match, abandon this execution model and treat the instruction as `UNPREDICTABLE`.
5. Perform the rest of the operation pseudocode for the instruction description that contains the encoding diagram. That pseudocode starts with all variables set to the values they were left with by the encoding-specific pseudocode.

The `ConditionPassed()` call in the common pseudocode (if present) performs step 2, and the `EncodingSpecificOperations()` call performs steps 3 and 4.

1.1.1 Pseudocode

The pseudocode provides precise descriptions of what instructions do, subject to the limitations described in *Limitations of pseudocode* on page AppxI-4. Instruction fields are referred to by the names shown in the encoding diagram for the instruction. The pseudocode is described in detail in the sections:

- *Data types* on page AppxI-5
- *Expressions* on page AppxI-9
- *Operators and built-in functions* on page AppxI-11
- *Statements and program structure* on page AppxI-17

Some pseudocode helper functions are described in *Miscellaneous helper procedures and functions* on page AppxI-22.

I.2 Limitations of pseudocode

The pseudocode descriptions of instruction functionality have a number of limitations. These are mainly due to the fact that, for clarity and brevity, the pseudocode is a sequential and mostly deterministic language.

These limitations include:

- Pseudocode does not describe the ordering requirements when an instruction generates multiple memory accesses, except in the case of SWP and SWPB instructions where the two accesses are to the same memory location. For a description of the ordering requirements on memory accesses see *Memory access order* on page A3-41.
- Pseudocode does not describe the exact rules when an UNDEFINED instruction fails its condition check. In such cases, the UNDEFINED pseudocode statement lies inside the if ConditionPassed() then ... structure, either directly or in the EncodingSpecificOperations() function call, and so the pseudocode indicates that the instruction executes as a NOP. *Conditional execution of undefined instructions* on page B1-51 describes the exact rules.
- Pseudocode does not describe the exact ordering requirements when one VFP instruction generates more than one floating-point exception. The exact rules are described in *Combinations of exceptions* on page A2-44.
- The pseudocode statements UNDEFINED, UNPREDICTABLE and SEE indicate behavior that differs from that indicated by the pseudocode being executed. If one of them is encountered:
 - Earlier behavior indicated by the pseudocode is only specified as occurring to the extent required to determine that the statement is executed.
 - No subsequent behavior indicated by the pseudocode occurs. This means that these statements terminate pseudocode execution.

For more information, see *Simple statements* on page AppxI-17.

- A processor exception can be taken during execution of the pseudocode for an instruction, either explicitly as a result of the execution of a pseudocode function such as DataAbort(), or implicitly, for example if an interrupt is taken during execution of an LDM instruction. If this happens, the pseudocode does not describe the extent to which the normal behavior of the instruction occurs. To determine that, see the descriptions of the processor exceptions in *Exceptions* on page B1-30.

I.3 Data types

This section describes:

- *General data type rules*
- *Bitstrings*
- *Integers* on page AppxI-6
- *Reals* on page AppxI-6
- *Booleans* on page AppxI-6
- *Enumerations* on page AppxI-6
- *Lists* on page AppxI-7
- *Arrays* on page AppxI-8.

I.3.1 General data type rules

ARM architecture pseudocode is a strongly-typed language. Every constant and variable is of one of the following types:

- bitstring
- integer
- boolean
- real
- enumeration
- list
- array.

The type of a constant is determined by its syntax. The type of a variable is normally determined by assignment to the variable, with the variable being implicitly declared to be of the same type as whatever is assigned to it. For example, the assignments $x = 1$, $y = '1'$, and $z = \text{TRUE}$ implicitly declare the variables x , y and z to have types integer, length-1 bitstring and boolean respectively.

Variables can also have their types declared explicitly by preceding the variable name with the name of the type. This is most often done in function definitions for the arguments and the result of the function.

These data types are described in more detail in the following sections.

I.3.2 Bitstrings

A bitstring is a finite-length string of 0s and 1s. Each length of bitstring is a different type. The minimum permitted length of a bitstring is 1.

The type name for bitstrings of length N is `bits(N)`. A synonym of `bits(1)` is `bit`.

Bitstring constants are written as a single quotation mark, followed by the string of 0s and 1s, followed by another single quotation mark. For example, the two constants of type `bit` are `'0'` and `'1'`. Spaces can be included in bitstrings for clarity.

A special form of bitstring constant with 'x' bits is permitted in bitstring comparisons. For details see *Equality and non-equality testing* on page AppxI-11.

Every bitstring value has a left-to-right order, with the bits being numbered in standard *little-endian* order. That is, the leftmost bit of a bitstring of length N is bit N-1 and its right-most bit is bit 0. This order is used as the most-significant-to-least-significant bit order in conversions to and from integers. For bitstring constants and bitstrings derived from encoding diagrams, this order matches the way they are printed.

Bitstrings are the only concrete data type in pseudocode, in the sense that they correspond directly to the contents of registers, memory locations, instructions, and so on. All of the remaining data types are abstract.

I.3.3 Integers

Pseudocode integers are unbounded in size and can be either positive or negative. That is, they are mathematical integers rather than what computer languages and architectures commonly call integers. Computer integers are represented in pseudocode as bitstrings of the appropriate length, associated with suitable functions to interpret those bitstrings as integers.

The type name for integers is `integer`.

Integer constants are normally written in decimal, such as 0, 15, -1234. They can also be written in C-style hexadecimal, such as `0x55` or `0x80000000`. Hexadecimal integer constants are treated as positive unless they have a preceding minus sign. For example, `0x80000000` is the integer $+2^{31}$. If -2^{31} needs to be written in hexadecimal, it must be written as `-0x80000000`.

I.3.4 Reals

Pseudocode reals are unbounded in size and precision. That is, they are mathematical real numbers, not computer floating-point numbers. Computer floating-point numbers are represented in pseudocode as bitstrings of the appropriate length, associated with suitable functions to interpret those bitstrings as reals.

The type name for reals is `real`.

Real constants are written in decimal with a decimal point (so 0 is an integer constant, but `0.0` is a real constant).

I.3.5 Booleans

A boolean is a logical true or false value.

The type name for booleans is `boolean`. This is not the same type as `bit`, which is a length-1 bitstring. Boolean constants are `TRUE` and `FALSE`.

I.3.6 Enumerations

An enumeration is a defined set of symbolic constants, such as:

```
enumeration InstrSet {InstrSet_ARM, InstrSet_Thumb, InstrSet_Jazelle, InstrSet_ThumbEE};
```

An enumeration always contains at least one symbolic constant, and symbolic constants are not permitted to be shared between enumerations.

Enumerations must be declared explicitly, though a variable of an enumeration type can be declared implicitly as usual by assigning one of the symbolic constants to it. By convention, each of the symbolic constants starts with the name of the enumeration followed by an underscore. The name of the enumeration is its type name, and the symbolic constants are its possible constants.

———— **Note** —————

Booleans are basically a pre-declared enumeration:

```
enumeration boolean {FALSE, TRUE};
```

that does not follow the normal naming convention and that has a special role in some pseudocode constructs, such as if statements.

I.3.7 Lists

A list is an ordered set of other data items, separated by commas and enclosed in parentheses, such as:

```
(bits(32) shifter_result, bit shifter_carry_out)
```

A list always contains at least one data item.

Lists are often used as the return type for a function that returns multiple results. For example, this particular list is the return type of the function `Shift_C()` that performs a standard ARM shift or rotation, when its first operand is of type `bits(32)`.

Some specific pseudocode operators use lists surrounded by other forms of bracketing than parentheses. These are:

- Bitstring extraction operators, that use lists of bit numbers or ranges of bit numbers surrounded by angle brackets "`<...>`".
- Array indexing, that uses lists of array indexes surrounded by square brackets "`[...]`".
- Array-like function argument passing, that uses lists of function arguments surrounded by square brackets "`[...]`".

Each combination of data types in a list is a separate type, with type name given by just listing the data types (that is, `(bits(32), bit)` in the above example). The general principle that types can be declared by assignment extends to the types of the individual list items in a list. For example:

```
(shift_t, shift_n) = ('00', 0);
```

implicitly declares `shift_t`, `shift_n` and `(shift_t, shift_n)` to be of types `bits(2)`, `integer` and `(bits(2), integer)` respectively.

A list type can also be explicitly named, with explicitly named elements in the list. For example:

```
type ShiftSpec is (bits(2) shift, integer amount);
```

After this definition and the declaration:

```
ShiftSpec abc;
```

the elements of the resulting list can then be referred to as "abc.shift" and "abc.amount". This sort of qualified naming of list elements is only permitted for variables that have been explicitly declared, not for those that have been declared by assignment only.

Explicitly naming a type does not alter what type it is. For example, after the above definition of ShiftSpec, ShiftSpec and (bits(2), integer) are two different names for the same type, not the names of two different types. To avoid ambiguity in references to list elements, it is an error to declare a list variable multiple times using different names of its type or to qualify it with list element names not associated with the name by which it was declared.

An item in a list that is being assigned to can be written as "-" to indicate that the corresponding item of the assigned list value is discarded. For example:

```
(shifted, -) = LSL_C(operand, amount);
```

List constants are written as a list of constants of the appropriate types, like ('00', 0) in the above example.

I.3.8 Arrays

Pseudocode arrays are indexed by either enumerations or integer ranges (represented by the lower inclusive end of the range, then "..", then the upper inclusive end of the range). For example:

```
enumeration PhysReg {
    PhysReg_R0,    PhysReg_R1,    PhysReg_R2,    PhysReg_R3,
    PhysReg_R4,    PhysReg_R5,    PhysReg_R6,    PhysReg_R7,
    PhysReg_R8,    PhysReg_R8fiq, PhysReg_R9,    PhysReg_R9fiq,
    PhysReg_R10,   PhysReg_R10fiq, PhysReg_R11,   PhysReg_R11fiq,
    PhysReg_R12,   PhysReg_R12fiq,
    PhysReg_SP,    PhysReg_SPfiq,  PhysReg_SPirq, PhysReg_SPsvc, PhysReg_SPabt,
    PhysReg_SPund, PhysReg_SPmon,
    PhysReg_LR,    PhysReg_LRfiq,  PhysReg_LRirq, PhysReg_LRsvc, PhysReg_LRabt,
    PhysReg_LRund, PhysReg_LRmon,
    PhysReg_PC};
array bits(32) _R[PhysReg];
array bits(8) _Memory[0..0xFFFFFFFF];
```

Arrays are always explicitly declared, and there is no notation for a constant array. Arrays always contain at least one element, because enumerations always contain at least one symbolic constant and integer ranges always contain at least one integer.

Arrays do not usually appear directly in pseudocode. The items that syntactically look like arrays in pseudocode are usually array-like functions such as R[i], MemU[address, size] or Elem[vector, i, size]. These functions package up and abstract additional operations normally performed on accesses to the underlying arrays, such as register banking, memory protection, endian-dependent byte ordering, exclusive-access housekeeping and Advanced SIMD element processing.

I.4 Expressions

This section describes:

- *General expression syntax*
- *Operators and functions - polymorphism and prototypes* on page AppxI-10
- *Precedence rules* on page AppxI-10.

I.4.1 General expression syntax

An expression is one of the following:

- a constant
- a variable, optionally preceded by a data type name to declare its type
- the word UNKNOWN preceded by a data type name to declare its type
- the result of applying a language-defined operator to other expressions
- the result of applying a function to other expressions.

Variable names normally consist of alphanumeric and underscore characters, starting with an alphabetic or underscore character.

Each register described in the text is to be regarded as declaring a correspondingly named bitstring variable, and that variable has the stated behavior of the register. For example, if a bit of a register is defined as RAZ/WI, then the corresponding bit of its variable reads as 0 and ignore writes.

An expression like `bits(32) UNKNOWN` indicates that the result of the expression is a value of the given type, but the architecture does not specify what value it is and software must not rely on such values. The value produced must not constitute a security hole and must not be promoted as providing any useful information to software. (This was called an UNPREDICTABLE value in previous ARM architecture documentation. It is related to but not the same as UNPREDICTABLE, which says that the entire architectural state becomes similarly unspecified.)

A subset of expressions are assignable. That is, they can be placed on the left-hand side of an assignment. This subset consists of:

- Variables
- The results of applying some operators to other expressions. The description of each language-defined operator that can generate an assignable expression specifies the circumstances under which it does so. (For example, those circumstances might include one or more of the expressions the operator operates on themselves being assignable expressions.)
- The results of applying array-like functions to other expressions. The description of an array-like function specifies the circumstances under which it can generate an assignable expression.

Every expression has a data type. This is determined by:

- For a constant, the syntax of the constant.
- For a variable, there are three possible sources for the type
 - its optional preceding data type name

- a data type it was given earlier in the pseudocode by recursive application of this rule
- a data type it is being given by assignment (either by direct assignment to it, or by assignment to a list of which it is a member).

It is a pseudocode error if none of these data type sources exists for a variable, or if more than one of them exists and they do not agree about the type.

- For a language-defined operator, the definition of the operator.
- For a function, the definition of the function.

I.4.2 Operators and functions - polymorphism and prototypes

Operators and functions in pseudocode can be polymorphic, producing different functionality when applied to different data types. Each of the resulting forms of an operator or function has a different prototype definition. For example, the operator + has forms that act on various combinations of integers, reals and bitstrings.

One particularly common form of polymorphism is between bitstrings of different lengths. This is represented by using bits(N), bits(M), and so on, in the prototype definition.

I.4.3 Precedence rules

The precedence rules for expressions are:

1. Constants, variables and function invocations are evaluated with higher priority than any operators using their results.
2. Expressions on integers follow the normal *exponentiation before multiply/divide before add/subtract* operator precedence rules, with sequences of multiply/divides or add/subtracts evaluated left-to-right.
3. Other expressions must be parenthesized to indicate operator precedence if ambiguity is possible, but need not be if all permitted precedence orders under the type rules necessarily lead to the same result. For example, if i, j and k are integer variables, $i > 0 \ \&\& \ j > 0 \ \&\& \ k > 0$ is acceptable, but $i > 0 \ \&\& \ j > 0 \ || \ k > 0$ is not.

I.5 Operators and built-in functions

This section describes:

- *Operations on generic types*
- *Operations on booleans*
- *Bitstring manipulation* on page AppxI-12
- *Arithmetic* on page AppxI-14.

I.5.1 Operations on generic types

The following operations are defined for all types.

Equality and non-equality testing

Any two values x and y of the same type can be tested for equality by the expression $x == y$ and for non-equality by the expression $x != y$. In both cases, the result is of type `boolean`.

A special form of comparison with a bitstring constant that includes 'x' bits as well as '0' and '1' bits is permitted. The bits corresponding to the 'x' bits are ignored in determining the result of the comparison. For example, if `opcode` is a 4-bit bitstring, `opcode == '1x0x'` is equivalent to `opcode<3> == '1' && opcode<1> == '0'`. This special form is also permitted in the implied equality comparisons in when parts of `case ... of ...` structures.

Conditional selection

If x and y are two values of the same type and t is a value of type `boolean`, then `if t then x else y` is an expression of the same type as x and y that produces x if t is `TRUE` and y if t is `FALSE`.

I.5.2 Operations on booleans

If x is a `boolean`, then `!x` is its logical inverse.

If x and y are booleans, then `x && y` is the result of ANDing them together. As in the C language, if x is `FALSE`, the result is determined to be `FALSE` without evaluating y .

If x and y are booleans, then `x || y` is the result of ORing them together. As in the C language, if x is `TRUE`, the result is determined to be `TRUE` without evaluating y .

If x and y are booleans, then `x ^ y` is the result of exclusive-ORing them together.

I.5.3 Bitstring manipulation

The following bitstring manipulation functions are defined:

Bitstring length and most significant bit

If x is a bitstring, the bitstring length function $\text{Len}(x)$ returns its length as an integer, and $\text{TopBit}(x)$ is the leftmost bit of x ($= x\langle\text{Len}(x)-1\rangle$ using bitstring extraction).

Bitstring concatenation and replication

If x and y are bitstrings of lengths N and M respectively, then $x:y$ is the bitstring of length $N+M$ constructed by concatenating x and y in left-to-right order.

If x is a bitstring and n is an integer with $n > 0$, $\text{Replicate}(x,n)$ is the bitstring of length $n*\text{Len}(x)$ consisting of n copies of x concatenated together, and $\text{Zeros}(n) = \text{Replicate}('0',n)$, $\text{Ones}(n) = \text{Replicate}('1',n)$.

Bitstring extraction

The bitstring extraction operator extracts a bitstring from either another bitstring or an integer. Its syntax is $x\langle\text{integer_list}\rangle$, where x is the integer or bitstring being extracted from, and $\langle\text{integer_list}\rangle$ is a list of integers enclosed in angle brackets rather than the usual parentheses. The length of the resulting bitstring is equal to the number of integers in $\langle\text{integer_list}\rangle$. In $x\langle\text{integer_list}\rangle$, each of the integers in $\langle\text{integer_list}\rangle$ must be:

- ≥ 0
- $< \text{Len}(x)$ if x is a bitstring.

The definition of $x\langle\text{integer_list}\rangle$ depends on whether integer_list contains more than one integer. If it does, $x\langle i,j,k,\dots,n\rangle$ is defined to be the concatenation:

$$x\langle i\rangle : x\langle j\rangle : x\langle k\rangle : \dots : x\langle n\rangle$$

If integer_list consists of just one integer i , $x\langle i\rangle$ is defined to be:

- if x is a bitstring, '0' if bit i of x is a zero and '1' if bit i of x is a one.
- if x is an integer, let y be the unique integer in the range 0 to $2^{i+1}-1$ that is congruent to x modulo 2^{i+1} . Then $x\langle i\rangle$ is '0' if $y < 2^i$ and '1' if $y \geq 2^i$.

Loosely, this second definition treats an integer as equivalent to a sufficiently long two's complement representation of it as a bitstring.

In $\langle\text{integer_list}\rangle$, the notation $i:j$ with $i \geq j$ is shorthand for the integers in order from i down to j , both ends inclusive. For example, $\text{instr}\langle 31:28\rangle$ is shorthand for $\text{instr}\langle 31,30,29,28\rangle$.

The expression $x\langle\text{integer_list}\rangle$ is assignable provided x is an assignable bitstring and no integer appears more than once in $\langle\text{integer_list}\rangle$. In particular, $x\langle i\rangle$ is assignable if x is an assignable bitstring and $0 \leq i < \text{Len}(x)$.

Encoding diagrams for registers frequently show named bits or multi-bit fields. For example, the encoding diagram for the APSR shows its bit<31> as N. In such cases, the syntax APSR.N is used as a more readable synonym for APSR<31>.

Logical operations on bitstrings

If x is a bitstring, $\text{NOT}(x)$ is the bitstring of the same length obtained by logically inverting every bit of x .

If x and y are bitstrings of the same length, $x \text{ AND } y$, $x \text{ OR } y$, and $x \text{ EOR } y$ are the bitstrings of that same length obtained by logically ANDing, ORing, and exclusive-ORing corresponding bits of x and y together.

Bitstring count

If x is a bitstring, $\text{BitCount}(x)$ produces an integer result equal to the number of bits of x that are ones.

Testing a bitstring for being all zero or all ones

If x is a bitstring, $\text{IsZero}(x)$ produces TRUE if all of the bits of x are zeros and FALSE if any of them are ones, and $\text{IsZeroBit}(x)$ produces '1' if all of the bits of x are zeros and '0' if any of them are ones. $\text{IsOnes}(x)$ and $\text{IsOnesBit}(x)$ work in the corresponding way. So:

```
IsZero(x)    = (BitCount(x) == 0)
IsOnes(x)   = (BitCount(x) == Len(x))
IsZeroBit(x) = if IsZero(x) then '1' else '0'
IsOnesBit(x) = if IsOnes(x) then '1' else '0'
```

Lowest and highest set bits of a bitstring

If x is a bitstring, and $N = \text{Len}(x)$:

- $\text{LowestSetBit}(x)$ is the minimum bit number of any of its bits that are ones. If all of its bits are zeros, $\text{LowestSetBit}(x) = N$.
- $\text{HighestSetBit}(x)$ is the maximum bit number of any of its bits that are ones. If all of its bits are zeros, $\text{HighestSetBit}(x) = -1$.
- $\text{CountLeadingZeroBits}(x) = N - 1 - \text{HighestSetBit}(x)$ is the number of zero bits at the left end of x , in the range 0 to N .
- $\text{CountLeadingSignBits}(x) = \text{CountLeadingZeroBits}(x \langle N-1:1 \rangle \text{ EOR } x \langle N-2:0 \rangle)$ is the number of copies of the sign bit of x at the left end of x , excluding the sign bit itself, and is in the range 0 to $N-1$.

Zero-extension and sign-extension of bitstrings

If x is a bitstring and i is an integer, then $\text{ZeroExtend}(x, i)$ is x extended to a length of i bits, by adding sufficient zero bits to its left. That is, if $i = \text{Len}(x)$, then $\text{ZeroExtend}(x, i) = x$, and if $i > \text{Len}(x)$, then:

```
ZeroExtend(x, i) = Replicate('0', i - Len(x)) : x
```

If x is a bitstring and i is an integer, then $\text{SignExtend}(x, i)$ is x extended to a length of i bits, by adding sufficient copies of its leftmost bit to its left. That is, if $i = \text{Len}(x)$, then $\text{SignExtend}(x, i) = x$, and if $i > \text{Len}(x)$, then:

$\text{SignExtend}(x, i) = \text{Replicate}(\text{TopBit}(x), i - \text{Len}(x)) : x$

It is a pseudocode error to use either $\text{ZeroExtend}(x, i)$ or $\text{SignExtend}(x, i)$ in a context where it is possible that $i < \text{Len}(x)$.

Converting bitstrings to integers

If x is a bitstring, $\text{SInt}(x)$ is the integer whose two's complement representation is x :

```
// SInt()
// =====

integer SInt(bits(N) x)
    result = 0;
    for i = 0 to N-1
        if x<i> == '1' then result = result + 2^i;
        if x<N-1> == '1' then result = result - 2^N;
    return result;
```

$\text{UInt}(x)$ is the integer whose unsigned representation is x :

```
// UInt()
// =====

integer UInt(bits(N) x)
    result = 0;
    for i = 0 to N-1
        if x<i> == '1' then result = result + 2^i;
    return result;
```

$\text{Int}(x, \text{unsigned})$ returns either $\text{SInt}(x)$ or $\text{UInt}(x)$ depending on the value of its second argument:

```
// Int()
// =====

integer Int(bits(N) x, boolean unsigned)
    result = if unsigned then UInt(x) else SInt(x);
    return result;
```

I.5.4 Arithmetic

Most pseudocode arithmetic is performed on integer or real values, with operands being obtained by conversions from bitstrings and results converted back to bitstrings afterwards. As these data types are the unbounded mathematical types, no issues arise about overflow or similar errors.

Unary plus, minus and absolute value

If x is an integer or real, then $+x$ is x unchanged, $-x$ is x with its sign reversed, and $\text{Abs}(x)$ is the absolute value of x . All three are of the same type as x .

Addition and subtraction

If x and y are integers or reals, $x+y$ and $x-y$ are their sum and difference. Both are of type integer if x and y are both of type integer, and real otherwise.

Addition and subtraction are particularly common arithmetic operations in pseudocode, and so it is also convenient to have definitions of addition and subtraction acting directly on bitstring operands.

If x and y are bitstrings of the same length $N = \text{Len}(x) = \text{Len}(y)$, then $x+y$ and $x-y$ are the least significant N bits of the results of converting them to integers and adding or subtracting them. Signed and unsigned conversions produce the same result:

$$\begin{aligned} x+y &= (\text{SInt}(x) + \text{SInt}(y))\langle N-1:0 \rangle \\ &= (\text{UInt}(x) + \text{UInt}(y))\langle N-1:0 \rangle \\ x-y &= (\text{SInt}(x) - \text{SInt}(y))\langle N-1:0 \rangle \\ &= (\text{UInt}(x) - \text{UInt}(y))\langle N-1:0 \rangle \end{aligned}$$

If x is a bitstring of length N and y is an integer, $x+y$ and $x-y$ are the bitstrings of length N defined by $x+y = x + y\langle N-1:0 \rangle$ and $x-y = x - y\langle N-1:0 \rangle$. Similarly, if x is an integer and y is a bitstring of length M , $x+y$ and $x-y$ are the bitstrings of length M defined by $x+y = x\langle M-1:0 \rangle + y$ and $x-y = x\langle M-1:0 \rangle - y$.

Comparisons

If x and y are integers or reals, then $x == y$, $x != y$, $x < y$, $x <= y$, $x > y$, and $x >= y$ are equal, not equal, less than, less than or equal, greater than, and greater than or equal comparisons between them, producing boolean results. In the case of $==$ and $!=$, this extends the generic definition applying to any two values of the same type to also act between integers and reals.

Multiplication

If x and y are integers or reals, then $x * y$ is the product of x and y , of type integer if both x and y are of type integer and otherwise of type real.

Division and modulo

If x and y are integers or reals, then x / y is the result of dividing x by y , and is always of type real.

If x and y are integers, then $x \text{ DIV } y$ and $x \text{ MOD } y$ are defined by:

$$\begin{aligned} x \text{ DIV } y &= \text{RoundDown}(x / y) \\ x \text{ MOD } y &= x - y * (x \text{ DIV } y) \end{aligned}$$

It is a pseudocode error to use any x / y , $x \text{ MOD } y$, or $x \text{ DIV } y$ in any context where y can be zero.

Square Root

If x is an integer or a real, $\text{Sqrt}(x)$ is its square root, and is always of type real.

Rounding and aligning

If x is a real:

- $\text{RoundDown}(x)$ produces the largest integer n such that $n \leq x$.
- $\text{RoundUp}(x)$ produces the smallest integer n such that $n \geq x$.
- $\text{RoundTowardsZero}(x)$ produces $\text{RoundDown}(x)$ if $x > 0.0$, 0 if $x == 0.0$, and $\text{RoundUp}(x)$ if $x < 0.0$.

If x and y are integers, $\text{Align}(x,y) = y * (x \text{ DIV } y)$ is an integer.

If x is a bitstring and y is an integer, $\text{Align}(x,y) = (\text{Align}(\text{UInt}(x),y)) \langle \text{Len}(x)-1:0 \rangle$ is a bitstring of the same length as x .

It is a pseudocode error to use either form of $\text{Align}(x,y)$ in any context where y can be 0. In practice, $\text{Align}(x,y)$ is only used with y a constant power of two, and the bitstring form used with $y = 2^n$ has the effect of producing its argument with its n low-order bits forced to zero.

Scaling

If n is an integer, 2^n is the result of raising 2 to the power n and is of type real.

If x and n are integers, then:

- $x \ll n = \text{RoundDown}(x * 2^n)$
- $x \gg n = \text{RoundDown}(x * 2^{(-n)})$.

Maximum and minimum

If x and y are integers or reals, then $\text{Max}(x,y)$ and $\text{Min}(x,y)$ are their maximum and minimum respectively. Both are of type integer if both x and y are of type integer and of type real otherwise.

I.6 Statements and program structure

This section describes the control statements used in the pseudocode.

I.6.1 Simple statements

The following simple statements must all be terminated with a semicolon, as shown.

Assignments

An assignment statement takes the form:

```
<assignable_expression> = <expression>;
```

Procedure calls

A procedure call takes the form:

```
<procedure_name>(<arguments>;
```

Return statements

A procedure return takes the form:

```
return;
```

and a function return takes the form:

```
return <expression>;
```

where <expression> is of the type the function prototype line declared.

UNDEFINED

The statement:

```
UNDEFINED;
```

indicates a special case that replaces the behavior defined by the current pseudocode (apart from behavior required to determine that the special case applies). The replacement behavior is that the Undefined Instruction exception is taken.

UNPREDICTABLE

The statement:

```
UNPREDICTABLE;
```

indicates a special case that replaces the behavior defined by the current pseudocode (apart from behavior required to determine that the special case applies). The replacement behavior is not architecturally defined and must not be relied upon by software. It must not constitute a security hole or halt or hang the system, and must not be promoted as providing any useful information to software.

SEE...

The statement:

```
SEE <reference>;
```

indicates a special case that replaces the behavior defined by the current pseudocode (apart from behavior required to determine that the special case applies). The replacement behavior is that nothing occurs as a result of the current pseudocode because some other piece of pseudocode defines the required behavior. The <reference> indicates where that other pseudocode can be found.

It usually refers to another instruction, but can also refer to another encoding or note of the same instruction.

IMPLEMENTATION_DEFINED

The statement:

```
IMPLEMENTATION_DEFINED <text>;
```

indicates a special case that specifies that the behavior is IMPLEMENTATION DEFINED. Following text can give more information.

SUBARCHITECTURE_DEFINED

The statement:

```
SUBARCHITECTURE_DEFINED <text>;
```

indicates a special case that specifies that the behavior is SUBARCHITECTURE DEFINED. Following text can give more information.

I.6.2 Compound statements

Indentation is normally used to indicate structure in compound statements. The statements contained in structures such as `if ... then ... else ...` or procedure and function definitions are indented more deeply than the statement itself, and their end is indicated by returning to the original indentation level or less.

Indentation is normally done by four spaces for each level.

if ... then ... else ...

A multi-line `if ... then ... else ...` structure takes the form:

```

if <boolean_expression> then
    <statement 1>
    <statement 2>
    ...
    <statement n>
elseif <boolean_expression> then
    <statement a>
    <statement b>
    ...
    <statement z>
else
    <statement A>
    <statement B>
    ...
    <statement Z>

```

The block of lines consisting of `elseif` and its indented statements is optional, and multiple such blocks can be used.

The block of lines consisting of `else` and its indented statements is optional.

Abbreviated one-line forms can be used when there are only simple statements in the `then` part and (if present) the `else` part, such as:

```

if <boolean_expression> then <statement 1>
if <boolean_expression> then <statement 1> else <statement A>
if <boolean_expression> then <statement 1> <statement 2> else <statement A>

```

Note

In these forms, `<statement 1>`, `<statement 2>` and `<statement A>` must be terminated by semicolons. This and the fact that the `else` part is optional are differences from the `if ... then ... else ...` expression.

repeat ... until ...

A repeat ... until ... structure takes the form:

```
repeat
  <statement 1>
  <statement 2>
  ...
  <statement n>
until <boolean_expression>;
```

while ... do

A while ... do structure takes the form:

```
while <boolean_expression>
  <statement 1>
  <statement 2>
  ...
  <statement n>
```

for ...

A for ... structure takes the form:

```
for <assignable_expression> = <integer_expr1> to <integer_expr2>
  <statement 1>
  <statement 2>
  ...
  <statement n>
```

case ... of ...

A case ... of ... structure takes the form:

```
case <expression> of
  when <constant values>
    <statement 1>
    <statement 2>
    ...
    <statement n>
  ... more "when" groups ...
  otherwise
    <statement A>
    <statement B>
    ...
    <statement Z>
```

where <constant values> consists of one or more constant values of the same type as <expression>, separated by commas. Abbreviated one line forms of when and otherwise parts can be used when they contain only simple statements.

If <expression> has a bitstring type, <constant values> can also include bitstring constants containing 'x' bits. For details see *Equality and non-equality testing* on page AppxI-11.

Procedure and function definitions

A procedure definition takes the form:

```
<procedure name>(<argument prototypes>)
  <statement 1>
  <statement 2>
  ...
  <statement n>
```

where the <argument prototypes> consists of zero or more argument definitions, separated by commas. Each argument definition consists of a type name followed by the name of the argument.

———— Note —————

This first prototype line is not terminated by a semicolon. This helps to distinguish it from a procedure call.

A function definition is similar, but also declares the return type of the function:

```
<return type> <function name>(<argument prototypes>)
  <statement 1>
  <statement 2>
  ...
  <statement n>
```

An array-like function is similar, but with square brackets:

```
<return type> <function name>[<argument prototypes>]
  <statement 1>
  <statement 2>
  ...
  <statement n>
```

An array-like function also usually has an assignment prototype:

```
<function name>[<argument prototypes>] = <value prototypes>
  <statement 1>
  <statement 2>
  ...
  <statement n>
```

I.6.3 Comments

Two styles of pseudocode comment exist:

- // starts a comment that is terminated by the end of the line.
- /* starts a comment that is terminated by */.

I.7 Miscellaneous helper procedures and functions

The functions described in this section are not part of the pseudocode specification. They are miscellaneous *helper* procedures and functions used by pseudocode that are not described elsewhere in this manual. Each has a brief description and a pseudocode prototype, except that the prototype is omitted where it is identical to the section title.

I.7.1 ArchVersion()

This function returns the major version number of the architecture.

```
integer ArchVersion()
```

I.7.2 BadReg()

This function performs the check for the register numbers 13 and 15 that are not permitted for many Thumb register specifiers.

```
// BadReg()
// =====

boolean BadReg(integer n)
    return n == 13 || n == 15;
```

I.7.3 Breakpoint()

This procedure causes a debug breakpoint to occur.

I.7.4 CallSupervisor()

This procedure causes the appropriate exception to occur to call a privileged supervisor.

In all architecture variants and profiles described in this manual, CallSupervisor() causes a Supervisor Call exception.

I.7.5 Coproc_Accepted()

This function determines, for a coprocessor and one of its coprocessor instructions:

- Whether access to the coprocessor is permitted by the CPACR and, if the Security Extensions are implemented, the NSACR.
- If access is permitted, whether the instruction is accepted by the coprocessor. The coprocessor architecture definition specifies which instructions it accepts and in what circumstances.

It returns TRUE if access is permitted and the coprocessor accepts the instruction, and FALSE otherwise.

```
boolean Coproc_Accepted(integer cp_num, bits(32) instr)
```

I.7.6 Coproc_DoneLoading()

This function determines for an LDC instruction whether enough words have been loaded.

boolean Coproc_DoneLoading(integer cp_num, bits(32) instr)

I.7.7 Coproc_DoneStoring()

This function determines for an STC instruction whether enough words have been stored.

boolean Coproc_DoneStoring(integer cp_num, bits(32) instr)

I.7.8 Coproc_GetOneWord()

This function obtains the word for an MRC instruction from the coprocessor.

bits(32) Coproc_GetOneWord(integer cp_num, bits(32) instr)

I.7.9 Coproc_GetTwoWords()

This function obtains the two words for an MRRC instruction from the coprocessor.

(bits(32), bits(32)) Coproc_GetTwoWords(integer cp_num, bits(32) instr)

I.7.10 Coproc_GetWordToStore()

This function obtains the next word to store for an STC instruction from the coprocessor

bits(32) Coproc_GetWordToStore(integer cp_num, bits(32) instr)

I.7.11 Coproc_InternalOperation()

This procedure instructs a coprocessor to perform the internal operation requested by a CDP instruction.

Coproc_InternalOperation(integer cp_num, bits(32) instr)

I.7.12 Coproc_SendLoadedWord()

This procedure sends a loaded word for an LDC instruction to the coprocessor.

Coproc_SendLoadedWord(bits(32) word, integer cp_num, bits(32) instr)

I.7.13 Coproc_SendOneWord()

This procedure sends the word for an MCR instruction to the coprocessor.

Coproc_SendOneWord(bits(32) word, integer cp_num, bits(32) instr)

I.7.14 Coproc_SendTwoWords()

This procedure sends the two words for an MCRR instruction to the coprocessor.

Coproc_SendTwoWords(bits(32) word1, bits(32) word2, integer cp_num, bits(32) instr)

I.7.15 EndOfInstruction()

This procedure terminates processing of the current instruction.

I.7.16 GenerateAlignmentException()

This procedure generates the appropriate exception for an alignment error.

In all architecture variants and profiles described in this manual, GenerateAlignmentException() generates a Data Abort exception.

I.7.17 GenerateCoprocesorException()

This procedure generates the appropriate exception for a rejected coprocessor instruction.

In all architecture variants and profiles described in this manual, GenerateCoprocesorException() generates an Undefined Instruction exception.

I.7.18 GenerateIntegerZeroDivide()

This procedure generates the appropriate exception for a division by zero in the integer division instructions SDIV and UDIV.

In the ARMv7-R profile, GenerateIntegerZeroDivide() generates an Undefined Instruction exception. The integer division instructions do not exist in any other architecture variant or profile described in this manual, so the GenerateIntegerZeroDivide() procedure is never called in those variants and profiles.

I.7.19 HaveMPExt()

This procedure returns true if the MP Extensions are implemented.

boolean HaveMPExt()

I.7.20 Hint_Debug()

This procedure supplies a hint to the debug system.

Hint_Debug(bits(4) option)

I.7.21 Hint_PreloadData()

This procedure performs a *preload data* hint.

Hint_PreloadData(bits(32) address)

I.7.22 Hint_PreloadDataForWrite()

This procedure performs a *preload data* hint with a probability that the use will be for a write.

Hint_PreloadDataForWrite(bits(32) address)

I.7.23 Hint_PreloadInstr()

This procedure performs a *preload instructions* hint.

Hint_PreloadInstr(bits(32) address)

I.7.24 Hint_Yield()

This procedure performs a *Yield* hint.

I.7.25 IntegerZeroDivideTrappingEnabled()

This function returns TRUE if the trapping of divisions by zero in the integer division instructions SDIV and UDIV is enabled, and FALSE otherwise.

In the ARMv7-R profile, this is controlled by the SCTL.R.DZ bit, see *c1, System Control Register (SCTLR)* on page B4-45. TRUE is returned if the bit is 1 and FALSE if it is 0. This function is never called in the A profile.

boolean IntegerZeroDivideTrappingEnabled()

I.7.26 IsExternalAbort()

This function returns TRUE if the abort currently being processed is an external abort and FALSE otherwise. It is only used in abort exception entry pseudocode.

boolean IsExternalAbort()

I.7.27 JazelleAcceptsExecution()

This function indicates whether Jazelle hardware will take over execution when a BXJ instruction is executed.

boolean JazelleAcceptsExecution()

I.7.28 MemorySystemArchitecture()

This function returns a value indicating which memory system architecture is in use on the system.

enumeration MemArch {MemArch_VMSA, MemArch_PMSA};

MemArch MemorySystemArchitecture()

I.7.29 ProcessorID()

This function returns an integer that uniquely identifies the executing processor in the system.

integer ProcessorID()

I.7.30 RemapRegsHaveResetValues()

This function returns TRUE if the remap registers PRRR and NMRR have their IMPLEMENTATION DEFINED reset values, and FALSE otherwise.

boolean RemapRegsHaveResetValues()

I.7.31 SwitchToJazelleExecution()

This procedure passes control of execution to Jazelle hardware (for a BXJ instruction).

I.7.32 ThisInstr()

This function returns the currently-executing instruction. It is only used on 32-bit instruction encodings at present.

bits(32) ThisInstr()

I.7.33 UnalignedSupport()

This function returns TRUE if the processor currently provides support for unaligned memory accesses, or FALSE otherwise. This is always TRUE in ARMv7, controllable by the SCTL.R bit in ARMv6, and always FALSE before ARMv6.

boolean UnalignedSupport()

Appendix J

Pseudocode Index

This appendix provides an index to pseudocode operators and functions that occur elsewhere in this manual. It contains the following sections:

- *Pseudocode operators and keywords* on page AppxJ-2
- *Pseudocode functions and procedures* on page AppxJ-6.

J.1 Pseudocode operators and keywords

Table J-1 lists the pseudocode operators and keywords, and is an index to their descriptions:

Table J-1 Pseudocode operators and keywords

Operator	Meaning	See
-	Unary minus on integers or reals	<i>Unary plus, minus and absolute value</i> on page AppxI-15
-	Subtraction of integers, reals and bitstrings	<i>Addition and subtraction</i> on page AppxI-15
+	Unary plus on integers or reals	<i>Unary plus, minus and absolute value</i> on page AppxI-15
+	Addition of integers, reals and bitstrings	<i>Addition and subtraction</i> on page AppxI-15
(...)	Around arguments of procedure	<i>Procedure calls</i> on page AppxI-17, <i>Procedure and function definitions</i> on page AppxI-21
(...)	Around arguments of function	<i>General expression syntax</i> on page AppxI-9, <i>Procedure and function definitions</i> on page AppxI-21
.	Extract named member from a list	<i>Lists</i> on page AppxI-7
.	Extract named bit or field from a register	<i>Bitstring extraction</i> on page AppxI-12
!	Boolean NOT	<i>Operations on booleans</i> on page AppxI-11
!=	Compare for non-equality (any type)	<i>Equality and non-equality testing</i> on page AppxI-11
!=	Compare for non-equality (between integers and reals)	<i>Comparisons</i> on page AppxI-15
&&	Boolean AND	<i>Operations on booleans</i> on page AppxI-11
*	Multiplication of integers and reals	<i>Multiplication</i> on page AppxI-15
/	Division of integers and reals (real result)	<i>Division and modulo</i> on page AppxI-15
/*...*/	Comment delimiters	<i>Comments</i> on page AppxI-21
//	Introduces comment terminated by end of line	<i>Comments</i> on page AppxI-21

Table J-1 Pseudocode operators and keywords (continued)

Operator	Meaning	See
:	Bitstring concatenation	<i>Bitstring concatenation and replication</i> on page AppxI-12
:	Integer range in bitstring extraction operator	<i>Bitstring extraction</i> on page AppxI-12
[...]	Around array index	<i>Arrays</i> on page AppxI-8
[...]	Around arguments of array-like function	<i>General expression syntax</i> on page AppxI-9, <i>Procedure and function definitions</i> on page AppxI-21
^	Boolean exclusive-OR	<i>Operations on booleans</i> on page AppxI-11
	Boolean OR	<i>Operations on booleans</i> on page AppxI-11
<	<i>Less than</i> comparison of integers and reals	<i>Comparisons</i> on page AppxI-15
<...>	Extraction of specified bits of bitstring or integer	<i>Bitstring extraction</i> on page AppxI-12
<<	Multiply integer by power of 2 (with rounding towards -infinity)	<i>Scaling</i> on page AppxI-16
<=	<i>Less than or equal</i> comparison of integers and reals	<i>Comparisons</i> on page AppxI-15
=	Assignment	<i>Assignments</i> on page AppxI-17
==	Compare for equality (any type)	<i>Equality and non-equality testing</i> on page AppxI-11
==	Compare for equality (between integers and reals)	<i>Comparisons</i> on page AppxI-15
>	<i>Greater than</i> comparison of integers and reals	<i>Comparisons</i> on page AppxI-15
>=	<i>Greater than or equal</i> comparison of integers and reals	<i>Comparisons</i> on page AppxI-15
>>	Divide integer by power of 2 (with rounding towards -infinity)	<i>Scaling</i> on page AppxI-16
2^N	Power of two (real result)	<i>Scaling</i> on page AppxI-16

Table J-1 Pseudocode operators and keywords (continued)

Operator	Meaning	See
AND	Bitwise AND of bitstrings	<i>Logical operations on bitstrings</i> on page AppxI-13
array	Keyword introducing array type definition	<i>Arrays</i> on page AppxI-8
bit	Bitstring type of length 1	<i>Bitstrings</i> on page AppxI-5
bits(N)	Bitstring type of length N	<i>Bitstrings</i> on page AppxI-5
boolean	Boolean type	<i>Booleans</i> on page AppxI-6
case ... of ...	Control structure	<i>case ... of...</i> on page AppxI-20
DIV	Quotient from integer division	<i>Division and modulo</i> on page AppxI-15
enumeration	Keyword introducing enumeration type definition	<i>Enumerations</i> on page AppxI-6
EOR	Bitwise EOR of bitstrings	<i>Logical operations on bitstrings</i> on page AppxI-13
FALSE	Boolean constant	<i>Booleans</i> on page AppxI-6
for ...	Control structure	<i>for...</i> on page AppxI-20
if ... then ... else ...	Expression selecting between two values	<i>Conditional selection</i> on page AppxI-11
if ... then ... else ...	Control structure	<i>if... then ... else ...</i> on page AppxI-19
IMPLEMENTATION_DEFINED	Describes IMPLEMENTATION_DEFINED behavior	<i>IMPLEMENTATION_DEFINED</i> on page AppxI-18
integer	Unbounded integer type	<i>Integers</i> on page AppxI-6
MOD	Remainder from integer division	<i>Division and modulo</i> on page AppxI-15
OR	Bitwise OR of bitstrings	<i>Logical operations on bitstrings</i> on page AppxI-13
otherwise	Introduces default case in case ... of ... control structure	<i>case ... of...</i> on page AppxI-20
real	Real number type	<i>Reals</i> on page AppxI-6
repeat ... until ...	Control structure	<i>repeat ... until ...</i> on page AppxI-20

Table J-1 Pseudocode operators and keywords (continued)

Operator	Meaning	See
return	Procedure or function return	<i>Return statements</i> on page AppxI-17
SEE	Points to other pseudocode to use instead	<i>SEE...</i> on page AppxI-18
SUBARCHITECTURE_DEFINED	Describes SUBARCHITECTURE_DEFINED behavior	<i>SUBARCHITECTURE_DEFINED</i> on page AppxI-18
TRUE	Boolean constant	<i>Booleans</i> on page AppxI-6
UNDEFINED	Cause Undefined Instruction exception	<i>UNDEFINED</i> on page AppxI-17
UNKNOWN	Unspecified value	<i>General expression syntax</i> on page AppxI-9
UNPREDICTABLE	Unspecified behavior	<i>UNPREDICTABLE</i> on page AppxI-18
when	Introduces specific case in case ... of ... control structure	<i>case ... of ...</i> on page AppxI-20
while ... do ...	Control structure	<i>while ... do</i> on page AppxI-20

J.2 Pseudocode functions and procedures

Table J-2 lists the pseudocode functions and procedures used in this manual, and is an index to their descriptions:

Table J-2 Pseudocode functions and procedures

Function	Meaning	See
<code>_Mem[]</code>	Basic memory accesses	<i>Basic memory accesses</i> on page B2-30
<code>Abs()</code>	Absolute value of an integer or real	<i>Unary plus, minus and absolute value</i> on page AppxI-15
<code>AddWithCarry()</code>	Addition of bitstrings, with carry input and carry/overflow outputs	<i>Pseudocode details of addition and subtraction</i> on page A2-8
<code>AdvancedSIMDExpandImm()</code>	Expansion of immediates for Advanced SIMD instructions	<i>Operation</i> on page A7-23
<code>Align()</code>	Align integer or bitstring to multiple of an integer	<i>Rounding and aligning</i> on page AppxI-16
<code>AlignmentFault()</code>	Generate an Alignment fault on the memory system in use	<i>Interfaces to memory system specific pseudocode</i> on page B2-30
<code>AlignmentFaultP()</code>	Generate an Alignment fault on the PMSA memory system	<i>Alignment fault</i> on page B4-79
<code>AlignmentFaultV()</code>	Generate an Alignment fault on the VMSA memory system	<i>Alignment fault</i> on page B3-156
<code>ALUWritePC()</code>	Write value to PC, with interworking for ARM only from ARMv7	<i>Pseudocode details of operations on ARM core registers</i> on page A2-12
<code>ArchVersion()</code>	Major version number of the architecture	<i>ArchVersion()</i> on page AppxI-22
<code>ARMEExpandImm()</code>	Expansion of immediates for ARM instructions	<i>Operation</i> on page A5-10
<code>ARMEExpandImm_C()</code>	Expansion of immediates for ARM instructions, with carry output	
<code>ASR()</code>	Arithmetic shift right of a bitstring	<i>Shift and rotate operations</i> on page A2-5
<code>ASR_C()</code>	Arithmetic shift right of a bitstring, with carry output	
<code>AssignToTLB()</code>	Allocate new TLB entry	<i>TLB operations</i> on page B3-158

Table J-2 Pseudocode functions and procedures (continued)

Function	Meaning	See
BadMode()	Test whether mode number is valid	<i>Pseudocode details of mode operations on page B1-8</i>
BadReg()	Test for register number 13 or 15	<i>BadReg()</i> on page AppxI-22
BigEndian()	Returns TRUE if big-endian memory accesses selected	<i>ENDIANSTATE on page A2-19</i>
BigEndianReverse()	Endian-reverse the bytes of a bitstring	<i>Reverse endianness on page B2-34</i>
BitCount()	Count number of ones in a bitstring	<i>Bitstring count on page AppxI-13</i>
BKPTInstrDebugEvent()	Generate a debug event for a BKPT instruction	<i>Debug events on page C3-27</i>
BranchTo()	Continue execution at specified address	<i>Pseudocode details of ARM core register operations on page B1-12</i>
BranchWritePC()	Write value to PC, without interworking	<i>Pseudocode details of operations on ARM core registers on page A2-12</i>
BreakpointDebugEvent()	Generate a debug event for a breakpoint	<i>Debug events on page C3-27</i>
BRPLinkMatch()	Check whether an access matches a linked Breakpoint Register Pair	<i>Breakpoints and Vector Catches on page C3-28</i>
BRPMatch()	Check whether an instruction unit access matches a Breakpoint Register Pair	
BXWritePC()	Write value to PC, with interworking	<i>Pseudocode details of operations on ARM core registers on page A2-12</i>
CallSupervisor()	Generate exception for SVC instruction	<i>CallSupervisor()</i> on page AppxI-22
CheckAdvSIMDEnabled()	Undefined Instruction exception if the Advanced SIMD extension is not enabled	<i>Pseudocode details of enabling the Advanced SIMD and VFP extensions on page B1-65</i>
CheckAdvSIMDorVFPEnabled()	Undefined Instruction exception if the specified one of the Advanced SIMD and VFP extensions is not enabled	<i>Pseudocode details of enabling the Advanced SIMD and VFP extensions on page B1-65</i>
CheckDomain()	VMSA check for Domain fault	<i>Domain checking on page B3-157</i>
CheckPermissions()	Memory system check of access permissions	<i>Access permission checking on page B2-37</i>

Table J-2 Pseudocode functions and procedures (continued)

Function	Meaning	See
CheckTLB()	Check whether TLB entry exists for an address	<i>TLB operations</i> on page B3-158
CheckVFPEnabled()	Undefined Instruction exception if the VFP extension is not enabled	<i>Pseudocode details of enabling the Advanced SIMD and VFP extensions</i> on page B1-65
ClearEventRegister()	Clear the Event Register of the current processor	<i>Pseudocode details of the Wait For Event lock mechanism</i> on page B1-46
ClearExclusiveByAddress()	Clear global exclusive monitor records for an address range	<i>Exclusive monitors operations</i> on page B2-35
ClearExclusiveLocal()	Clear local exclusive monitor record of a processor	
ConditionPassed()	Returns TRUE if the current instruction passes its condition check	<i>Pseudocode details of conditional execution</i> on page A8-9
Consistent()	Test identically-named instruction bits or fields are identical	<i>Instruction encoding diagrams and pseudocode</i> on page AppxI-2
Coproc_Accepted()	Determine whether a coprocessor accepts an instruction	<i>Coproc_Accepted()</i> on page AppxI-22
Coproc_DoneLoading()	Returns TRUE if enough words have been loaded, for an LDC or LDC2 instruction	<i>Coproc_DoneLoading()</i> on page AppxI-23
Coproc_DoneStoring()	Returns TRUE if enough words have been stored, for an STC or STC2 instruction	<i>Coproc_DoneStoring()</i> on page AppxI-23
Coproc_GetOneWord()	Get word from coprocessor, for an MRC or MRC2 instruction	<i>Coproc_GetOneWord()</i> on page AppxI-23
Coproc_GetTwoWords()	Get two words from coprocessor, for an MRRC or MRRC2 instruction	<i>Coproc_GetTwoWords()</i> on page AppxI-23
Coproc_GetWordToStore()	Get next word to store from coprocessor, for STC or STC2 instruction	<i>Coproc_GetWordToStore()</i> on page AppxI-23
Coproc_InternalOperation()	Instruct coprocessor to perform an internal operation, for a CDP or CDP2 instruction	<i>Coproc_InternalOperation()</i> on page AppxI-23

Table J-2 Pseudocode functions and procedures (continued)

Function	Meaning	See
Coproc_SendLoadedWord()	Send next loaded word to coprocessor, for LDC or LDC2 instruction	<i>Coproc_SendLoadedWord()</i> on page AppxI-23
Coproc_SendOneWord()	Send word to coprocessor, for an MCR or MCR2 instruction	<i>Coproc_SendOneWord()</i> on page AppxI-23
Coproc_SendTwoWords()	Send two words to coprocessor, for an MCRR or MCRR2 instruction	<i>Coproc_SendTwoWords()</i> on page AppxI-24
CountLeadingSignBits()	Number of identical sign bits at left end of bitstring, excluding the leftmost bit itself	<i>Lowest and highest set bits of a bitstring</i> on page AppxI-13
CountLeadingZeroBits()	Number of zeros at left end of bitstring	
CPSRWriteByInstr()	CPSR write by an instruction	<i>Pseudocode details of PSR operations</i> on page B1-20
CurrentCond()	Returns condition for current instruction	<i>Pseudocode details of conditional execution</i> on page A8-9
CurrentInstrSet()	Returns the instruction set currently in use	<i>ISSETSTATE</i> on page A2-15
CurrentModeIsPrivileged()	Returns TRUE if current mode is privileged	<i>Pseudocode details of mode operations</i> on page B1-8
CurrentModeIsUserOrSystem()	Returns TRUE if current mode is User or System mode	
D[]	Doubleword / double-precision view of the Advanced SIMD and VFP registers	<i>Advanced SIMD and VFP extension registers</i> on page A2-21
DataAbort()	Cause a Data Abort exception of a specified type	<i>Data Abort exception</i> on page B2-39
DataMemoryBarrier()	Perform a Data Memory Barrier operation	<i>Pseudocode details of memory barriers</i> on page A3-50
DataSynchronizationBarrier()	Perform a Data Synchronization Barrier operation	
Debug_CheckDataAccess()	Check a data access for watchpoints	<i>Watchpoints</i> on page C3-35
Debug_CheckInstruction()	Check an instruction access for breakpoints and vector catches	<i>Breakpoints and Vector Catches</i> on page C3-28

Table J-2 Pseudocode functions and procedures (continued)

Function	Meaning	See
DecodeImmShift()	Decode shift type and amount for an immediate shift	<i>Pseudocode details of instruction-specified shifts and rotates on page A8-11</i>
DecodeRegShift()	Decode shift type for a register-controlled shift	
DefaultAttrs()	Determine memory attributes for an address in the PMSA default memory map	<i>Default memory map attributes on page B4-81</i>
DefaultTEXDecode()	Determine default memory attributes for a set of TEX[2:0], C, B bits	<i>Default memory access decode on page B2-37</i>
Elem[]	Access element of a vector	<i>Advanced SIMD vectors on page A2-26</i>
EncodingSpecificOperations()	Invoke encoding-specific pseudocode and <i>should be</i> checks	<i>Instruction encoding diagrams and pseudocode on page AppXI-2</i>
EndOfInstruction()	Terminate processing of current instruction	<i>EndOfInstruction()</i> on page AppXI-24
EventRegistered()	Determine whether the Event Register of the current processor is set	<i>Pseudocode details of the Wait For Event lock mechanism on page B1-46</i>
ExclusiveMonitorsPass()	Check whether Store-Exclusive operation has control of exclusive monitors	<i>Exclusive monitors operations on page B2-35</i>
ExcVectorBase()	Return non-Monitor mode exception base address for current security state	<i>Operation on page B1-33</i>
FixedToFP()	Convert integer or fixed-point to floating-point	<i>Conversions on page A2-64</i>
FPAbs()	Floating-point absolute value	<i>Negation and absolute value on page A2-47</i>
FPAAdd()	Floating-point addition	<i>Addition and subtraction on page A2-55</i>
FPCompare()	Floating-point comparison, producing NZCV flag result	<i>Comparisons on page A2-53</i>
FPCompareEQ()	Floating-point test for equality	

Table J-2 Pseudocode functions and procedures (continued)

Function	Meaning	See
FPCompareGE()	Floating-point test for greater than or equal	<i>Comparisons</i> on page A2-53
FPCompareGT()	Floating-point test for greater than	
FPDefaultNaN()	Generate floating-point default NaN	<i>Generation of specific floating-point values</i> on page A2-46
FPDiv()	Floating-point division	<i>Multiplication and division</i> on page A2-57
FPDoubleToSingle()	Convert double-precision floating-point to single-precision floating-point	<i>Conversions</i> on page A2-64
FPHalfToSingle()	Convert half-precision floating-point to single-precision floating-point	
FPInfinity()	Generate floating-point infinity	<i>Generation of specific floating-point values</i> on page A2-46
FPMax()	Floating-point maximum	<i>Maximum and minimum</i> on page A2-55
FPMaxNormal()	Generate maximum normalized floating-point value	<i>Generation of specific floating-point values</i> on page A2-46
FPMin()	Floating-point minimum	<i>Maximum and minimum</i> on page A2-55
FPMul()	Floating-point multiplication	<i>Multiplication and division</i> on page A2-57
FPNeg()	Floating-point negation	<i>Negation and absolute value</i> on page A2-47
FPProcessException()	Process a floating-point exception	<i>Floating-point exception and NaN handling</i> on page A2-49
FPProcessNaN()	Generate correct result and exceptions for a NaN operand	
FPProcessNaNs()	Perform NaN operand checks and processing for a 2-operand floating-point operation	

Table J-2 Pseudocode functions and procedures (continued)

Function	Meaning	See
FPRecipEstimate()	Floating-point reciprocal estimate	<i>Reciprocal estimate and step</i> on page A2-58
FPRecipStep()	Floating-point 2-xy operation for Newton-Raphson reciprocal iteration	
FPRound()	Floating-point rounding	<i>Floating-point rounding</i> on page A2-51
FPSingleToDouble()	Convert single-precision floating-point to double-precision floating-point	<i>Conversions</i> on page A2-64
FPSingleToHalf()	Convert single-precision floating-point to half-precision floating-point	
FPSqrtEstimate()	Floating-point reciprocal square root estimate	<i>Reciprocal square root</i> on page A2-61
FPSqrtStep()	Floating-point $(3-xy)/2$ operation for Newton-Raphson reciprocal square root iteration	
FPSqrt()	Floating-point square root	<i>Square root</i> on page A2-60
FPSub()	Floating-point subtraction	<i>Addition and subtraction</i> on page A2-55
FPTThree()	Generate floating-point value 3.0	<i>Generation of specific floating-point values</i> on page A2-46
FPToFixed()	Convert floating-point to integer or fixed-point	<i>Conversions</i> on page A2-64
FPTwo()	Generate floating-point value 2.0	<i>Generation of specific floating-point values</i> on page A2-46
FPUnpack()	Produce type, sign bit and real value of a floating-point number	<i>Floating-point value unpacking</i> on page A2-48
FPZero()	Generate floating-point zero	<i>Generation of specific floating-point values</i> on page A2-46
GenerateAlignmentException()	Generate the exception for a failed address alignment check	<i>GenerateAlignmentException()</i> on page AppxI-24
GenerateCoproprocessorException()	Generate the exception for an unclaimed coprocessor instruction	<i>GenerateCoproprocessorException()</i> on page AppxI-24

Table J-2 Pseudocode functions and procedures (continued)

Function	Meaning	See
GenerateIntegerZeroDivide()	Generate the exception for a trapped divide-by-zero for an integer divide instruction	<i>GenerateIntegerZeroDivide()</i> on page AppxI-24
HaveMPExt()	Returns TRUE if the MP Extensions are implemented	<i>HaveMPExt()</i> on page AppxI-24
HaveSecurityExt()	Returns TRUE if the Security Extensions are implemented	<i>Pseudocode details of Secure state operations</i> on page B1-28
HighestSetBit()	Position of leftmost 1 in a bitstring	<i>Lowest and highest set bits of a bitstring</i> on page AppxI-13
Hint_Debug()	Perform function of DBG hint instruction	<i>Hint_Debug()</i> on page AppxI-24
Hint_PreloadData()	Perform function of PLD memory hint instruction	<i>Hint_PreloadData()</i> on page AppxI-25
Hint_PreloadDataForWrite()	Perform function of PLDW Memory hint instruction	<i>Hint_PreloadDataForWrite()</i> on page AppxI-25
Hint_PreloadInstr()	Perform function of PLI memory hint instruction	<i>Hint_PreloadInstr()</i> on page AppxI-25
Hint_Yield()	Perform function of YIELD hint instruction	<i>Hint_Yield()</i> on page AppxI-25
InITBlock()	Return TRUE if current instruction is in an IT block	<i>ITSTATE</i> on page A2-17
InstructionSynchronizationBarrier()	Perform an Instruction Synchronization Barrier operation	<i>Pseudocode details of memory barriers</i> on page A3-50
Int()	Convert bitstring to integer in argument-specified fashion	<i>Converting bitstrings to integers</i> on page AppxI-14
IntegerZeroDivideTrappingEnabled()	Check whether divide-by-zero trapping is enabled for integer divide instructions	<i>IntegerZeroDivideTrappingEnabled()</i> on page AppxI-25
IsExclusiveGlobal()	Check a global exclusive access record	<i>Exclusive monitors operations</i> on page B2-35
IsExclusiveLocal()	Check a local exclusive access record	
IsExternalAbort()	Returns TRUE if abort being processed is an external abort	<i>IsExternalAbort()</i> on page AppxI-25

Table J-2 Pseudocode functions and procedures (continued)

Function	Meaning	See
IsOnes()	Test for all-ones bitstring (Boolean result)	<i>Testing a bitstring for being all zero or all ones on page AppxI-13</i>
IsOnesBit()	Test for all-ones bitstring (bit result)	
IsSecure()	Returns TRUE in Secure state or if no Security Extensions	<i>Pseudocode details of Secure state operations on page B1-28</i>
IsZero()	Test for all-zeros bitstring (Boolean result)	<i>Testing a bitstring for being all zero or all ones on page AppxI-13</i>
IsZeroBit()	Test for all-zeros bitstring (bit result)	
ITAdvance()	Advance the ITSTATE bits to their values for the next instruction	<i>ITSTATE on page A2-17</i>
JazelleAcceptsExecution()	Returns TRUE if the Jazelle extension can start bytecode execution	<i>JazelleAcceptsExecution() on page AppxI-25</i>
LastInITBlock()	Return TRUE if current instruction is the last instruction of an IT block	<i>ITSTATE on page A2-17</i>
Len()	Bitstring length	<i>Bitstring length and most significant bit on page AppxI-12</i>
LoadWritePC()	Write value to PC, with interworking (without it before ARMv5T)	<i>Pseudocode details of operations on ARM core registers on page A2-12</i>
LookUpRName()	Find banked register for specified register number and mode	<i>Pseudocode details of ARM core register operations on page B1-12</i>
LowestSetBit()	Position of rightmost 1 in a bitstring	<i>Lowest and highest set bits of a bitstring on page AppxI-13</i>
LSL()	Logical shift left of a bitstring	<i>Shift and rotate operations on page A2-5</i>
LSL_C()	Logical shift left of a bitstring, with carry output	
LSR()	Logical shift right of a bitstring	
LSR_C()	Logical shift right of a bitstring, with carry output	
MarkExclusiveGlobal()	Set a global exclusive access record	<i>Exclusive monitors operations on page B2-35</i>
MarkExclusiveLocal()	Set a local exclusive access record	

Table J-2 Pseudocode functions and procedures (continued)

Function	Meaning	See
Max()	Maximum of integers or reals	<i>Maximum and minimum</i> on page AppxI-16
MemA[]	Memory access that must be aligned, at current privilege level	<i>Aligned memory accesses</i> on page B2-31
MemA_unpriv[]	Memory access that must be aligned, unprivileged	
MemA_with_priv[]	Memory access that must be aligned, at specified privilege level	
MemorySystemArchitecture()	Return memory architecture of system (VMSA or PMSA)	<i>MemorySystemArchitecture()</i> on page AppxI-26
MemU[]	Memory access without alignment requirement, at current privilege level	<i>Unaligned memory accesses</i> on page B2-32
MemU_unpriv[]	Memory access without alignment requirement, unprivileged	
MemU_with_priv[]	Memory access without alignment requirement, at specified privilege level	
Min()	Minimum of integers or reals	<i>Maximum and minimum</i> on page AppxI-16
NOT()	Bitwise inversion of a bitstring	<i>Logical operations on bitstrings</i> on page AppxI-13
NullCheckIfThumbEE()	Perform base register null check if a ThumbEE instruction	<i>Null checking</i> on page A9-3
Ones()	All-ones bitstring	<i>Bitstring concatenation and replication</i> on page AppxI-12
PCStoreValue()	Value stored when an ARM instruction stores the PC	<i>Pseudocode details of operations on ARM core registers</i> on page A2-12
PolynomialMult()	Multiplication of polynomials over {0, 1}	<i>Pseudocode details of polynomial multiplication</i> on page A2-67
ProcessorID()	Return integer identifying the processor	<i>ProcessorID()</i> on page AppxI-26
Q[]	Quadword view of the Advanced SIMD and VFP registers	<i>Advanced SIMD and VFP extension registers</i> on page A2-21

Table J-2 Pseudocode functions and procedures (continued)

Function	Meaning	See
R[]	Access the main ARM core register bank, using current mode	<i>Pseudocode details of ARM core register operations</i> on page B1-12
RBankSelect()	Evaluate register banking for R13, R14	
RemapRegsHaveResetValues()	Check PRRR and NMRR for reset values	<i>RemapRegsHaveResetValues()</i> on page AppxI-26
Replicate()	Bitstring replication	<i>Bitstring concatenation and replication</i> on page AppxI-12
RfiqBankSelect()	Evaluate register banking for R8-R12	<i>Pseudocode details of ARM core register operations</i> on page B1-12
Rmode[]	Access the main ARM core register bank, using specified mode	
ROR()	Rotate right of a bitstring	<i>Shift and rotate operations</i> on page A2-5
ROR_C()	Rotate right of a bitstring, with carry output	
RoundDown()	Round real to integer (rounding towards -infinity)	<i>Rounding and aligning</i> on page AppxI-16
RoundTowardsZero()	Round real to integer (rounding towards zero)	
RoundUp()	Round real to integer (rounding towards +infinity)	
RRX()	Rotate right with extend of a bitstring	<i>Shift and rotate operations</i> on page A2-5
RRX_C()	Rotate right with extend of a bitstring, with carry output	
S[]	Single word / single-precision view of the Advanced SIMD and VFP registers	<i>Advanced SIMD and VFP extension registers</i> on page A2-21
Sat()	Convert integer to bitstring with specified saturation	<i>Pseudocode details of saturation</i> on page A2-9
SatQ()	Convert integer to bitstring with specified saturation, with saturated flag output	
SelectInstrSet()	Sets the instruction set currently in use	<i>ISETSTATE</i> on page A2-15

Table J-2 Pseudocode functions and procedures (continued)

Function	Meaning	See
SendEvent()	Perform function of SEV hint instruction	<i>Pseudocode details of the Wait For Event lock mechanism on page B1-46</i>
SerializeVFP()	Ensure exceptional conditions in preceding VFP instructions have been detected	<i>Asynchronous bounces, serialization, and VFP exception barriers on page B1-70</i>
SetExclusiveMonitors()	Set exclusive monitors for a Load-Exclusive operation	<i>Exclusive monitors operations on page B2-35</i>
Shift()	Perform a specified shift by a specified amount on a bitstring	<i>Pseudocode details of instruction-specified shifts and rotates on page A8-11</i>
Shift_C()	Perform a specified shift by a specified amount on a bitstring, with carry output	
SignedSat()	Convert integer to bitstring with signed saturation	<i>Pseudocode details of saturation on page A2-9</i>
SignedSatQ()	Convert integer to bitstring with signed saturation, with saturated flag output	
SignExtend()	Extend bitstring to left with copies of its leftmost bit	<i>Zero-extension and sign-extension of bitstrings on page AppxI-13</i>
SInt()	Convert bitstring to integer in signed (two's complement) fashion	<i>Converting bitstrings to integers on page AppxI-14</i>
SPSR[]	Access the SPSR of the current mode	<i>Pseudocode details of PSR operations on page B1-20</i>
SPSRWriteByInstr()	SPSR write by an instruction	
SwitchToJazelleExecution()	Start Jazelle extension execution of bytecodes	<i>SwitchToJazelleExecution() on page AppxI-26</i>
TakeDataAbortException()	Perform a Data Abort exception entry	<i>Data Abort exception on page B1-55</i>
TakeFIQException()	Perform an FIQ interrupt exception entry	<i>FIQ exception on page B1-60</i>
TakeIRQException()	Perform an IRQ interrupt exception entry	<i>IRQ exception on page B1-58</i>
TakePrefetchAbortException()	Perform a Prefetch Abort exception entry	<i>Prefetch Abort exception on page B1-54</i>
TakeReset()	Perform a Reset exception entry	<i>Reset on page B1-48</i>

Table J-2 Pseudocode functions and procedures (continued)

Function	Meaning	See
TakeSMCEXception()	Perform a Secure Monitor Call exception entry	<i>Secure Monitor Call (SMC) exception</i> on page B1-53
TakeSVCEXception()	Perform a Supervisor Call exception entry	<i>Supervisor Call (SVC) exception</i> on page B1-52
TakeUndefInstrEXception()	Perform an Undefined Instruction exception entry	<i>Undefined Instruction exception</i> on page B1-49
ThisInstr()	Returns the bitstring encoding of the current instruction	<i>ThisInstr()</i> on page AppxI-26
ThumbExpandImm()	Expansion of immediates for Thumb instructions	<i>Operation</i> on page A6-18
ThumbExpandImm_C()	Expansion of immediates for Thumb instructions, with carry output	
TopBit()	Leftmost bit of a bitstring	<i>Bitstring length and most significant bit</i> on page AppxI-12
TranslateAddress()	Perform address translation and obtain memory attributes for a memory access	<i>Interfaces to memory system specific pseudocode</i> on page B2-30
TranslateAddressP()	Perform address translation and obtain memory attributes for a PMSA memory access	<i>Address translation</i> on page B4-79
TranslateAddressV()	Perform address translation and obtain memory attributes for a VMSA memory access	
TranslateVAtO_MVA()	Fast Context Switch Extension virtual address to modified virtual address translation	<i>Modified virtual addresses</i> on page AppxE-3
TranslationTableWalk()	Perform VMSA translation table walk	<i>Translation table walk</i> on page B3-158
UInt()	Convert bitstring to integer in unsigned fashion	<i>Converting bitstrings to integers</i> on page AppxI-14
UnalignedSupport()	Check whether unaligned memory access support (introduced in ARMv6) is in use	<i>UnalignedSupport()</i> on page AppxI-26

Table J-2 Pseudocode functions and procedures (continued)

Function	Meaning	See
UnsignedRecipEstimate()	Unsigned fixed-point reciprocal estimate	<i>Reciprocal estimate and step</i> on page A2-58
UnsignedRSqrtEstimate()	Unsigned fixed-point reciprocal square root estimate	<i>Reciprocal square root</i> on page A2-61
UnsignedSat()	Convert integer to bitstring with unsigned saturation	<i>Pseudocode details of saturation</i> on page A2-9
UnsignedSatQ()	Convert integer to bitstring with unsigned saturation, with saturated flag output	
VCR_OnTakingInterrupt()	Track most recently used interrupt vectors for vector catch purposes	<i>Breakpoints and Vector Catches</i> on page C3-28
VCRMatch()	Check whether a vector catch occurs for an instruction unit access	
VCRVectorMatch()	Check whether an instruction unit access matches a vector	
VectorCatchDebugEvent()	Generate a debug event for a vector catch	<i>Debug events</i> on page C3-27
VFPExcBarrier()	Ensure all outstanding VFP exception processing has occurred	<i>Asynchronous bounces, serialization, and VFP exception barriers</i> on page B1-70
VFPExpandImm()	Expansion of immediates for VFP extension instructions	<i>Operation</i> on page A7-25
VFPSmallRegisterBank()	Returns TRUE if 16-doubleword VFP extension register bank implemented	<i>Pseudocode details of Advanced SIMD and VFP extension registers</i> on page A2-23
WaitForEvent()	Wait until WFE instruction completes	<i>Pseudocode details of the Wait For Event lock mechanism</i> on page B1-46
WaitForInterrupt()	Wait until WFI instruction completes	<i>Pseudocode details of Wait For Interrupt</i> on page B1-48
WatchpointDebugEvent()	Generate a debug event for a watchpoint	<i>Debug events</i> on page C3-27

Table J-2 Pseudocode functions and procedures (continued)

Function	Meaning	See
WRPMatch()	Check whether a data access matches a Watchpoint Register Pair	<i>Watchpoints</i> on page C3-35
ZeroExtend()	Extend bitstring to left with zero bits	<i>Zero-extension and sign-extension of bitstrings</i> on page AppxI-13
Zeros()	All-zeros bitstring	<i>Bitstring concatenation and replication</i> on page AppxI-12

Appendix K

Register Index

This appendix provides an index to the descriptions of the ARM registers in this manual. It contains the following section:

- *Register index* on page AppxK-2.

K.1 Register index

Table K-1 shows the main description of each register. The CP15 control coprocessor registers are described separately for VMSA and PMSA implementations, in the sections:

- *CP15 registers for a VMSA implementation* on page B3-64
- *CP15 registers for a PMSA implementation* on page B4-22.

Table K-1 lists both descriptions of these registers. The PMSA and VMSA implementations of a register can differ.

Some CP15 registers are only present in a PMSA implementation, or only in a VMSA implementation. This is shown in Table K-1.

Table K-1 Register index

Register	In ^a	Description, see
Access Permissions, pre-ARMv6		<i>c5, Memory Region Access Permissions Registers (DAPR and IAPR)</i> on page AppxH-45
ACTLR	PMSA	<i>c1, Implementation defined Auxiliary Control Register (ACTLR)</i> on page B4-50
	VMSA	<i>c1, Implementation defined Auxiliary Control Register (ACTLR)</i> on page B3-103
ADFSR	PMSA	<i>c5, Auxiliary Data and Instruction Fault Status Registers (ADFSR and AIFSR)</i> on page B4-56
	VMSA	<i>c5, Auxiliary Data and Instruction Fault Status Registers (ADFSR and AIFSR)</i> on page B3-123
AIDR	PMSA	<i>c0, Implementation defined Auxiliary ID Register (AIDR)</i> on page B4-43
	VMSA	<i>c0, Implementation defined Auxiliary ID Register (AIDR)</i> on page B3-94
AIFSR	PMSA	<i>c5, Auxiliary Data and Instruction Fault Status Registers (ADFSR and AIFSR)</i> on page B4-56
	VMSA	<i>c5, Auxiliary Data and Instruction Fault Status Registers (ADFSR and AIFSR)</i> on page B3-123
APSR		<i>The Application Program Status Register (APSR)</i> on page A2-14
Authentication Status, Debug		<i>Authentication Status Register (DBGAUTHSTATUS)</i> on page C10-96
Auxiliary Control	PMSA	<i>c1, Implementation defined Auxiliary Control Register (ACTLR)</i> on page B4-50
	VMSA	<i>c1, Implementation defined Auxiliary Control Register (ACTLR)</i> on page B3-103

Table K-1 Register index (continued)

Register	In ^a	Description, see
Auxiliary Fault Status	PMSA	<i>c5, Auxiliary Data and Instruction Fault Status Registers (ADFSR and AIFSR) on page B4-56</i>
	VMSA	<i>c5, Auxiliary Data and Instruction Fault Status Registers (ADFSR and AIFSR) on page B3-123</i>
Auxiliary Feature 0		<i>c0, Auxiliary Feature Register 0 (ID_AFR0) on page B5-8</i>
Auxiliary ID	PMSA	<i>c0, Implementation defined Auxiliary ID Register (AIDR) on page B4-43</i>
	VMSA	<i>c0, Implementation defined Auxiliary ID Register (AIDR) on page B3-94</i>
Block Transfer Status, ARMv6		<i>c7, Block Transfer Status Register on page AppxG-43</i>
BPIALL	PMSA	<i>CP15 c7, Cache and branch predictor maintenance functions on page B4-68</i>
	VMSA	<i>CP15 c7, Cache and branch predictor maintenance functions on page B3-126</i>
BPIALLIS	PMSA	<i>CP15 c7, Cache and branch predictor maintenance functions on page B4-68</i>
	VMSA	<i>CP15 c7, Cache and branch predictor maintenance functions on page B3-126</i>
BPIMVA	PMSA	<i>CP15 c7, Cache and branch predictor maintenance functions on page B4-68</i>
	VMSA	<i>CP15 c7, Cache and branch predictor maintenance functions on page B3-126</i>
Breakpoint Control		<i>Breakpoint Control Registers (DBGBCR) on page C10-49</i>
Breakpoint value		<i>Breakpoint Value Registers (DBGBVR) on page C10-48</i>
c0 - c15	Generic	<i>Instruction descriptions of the CDP, CDP2, LDC, LDC2, MCR, MCR2, MCRR, MCRR2, MRC, MRC2, MRRC, MRRC2, STC, and STC2 generic coprocessor instructions.</i>
	PMSA	<i>Summary of CP15 register descriptions in a PMSA implementation on page B4-24</i>
	VMSA	<i>Summary of CP15 register descriptions in a VMSA implementation on page B3-66</i>
Cache Behavior Override, ARMv6 Security Extensions		<i>c9, Cache Behavior Override Register (CBOR) on page AppxG-49</i>

Table K-1 Register index (continued)

Register	In ^a	Description, see
Cache Dirty Status, ARMv6		<i>c7, Cache Dirty Status Register (CDSR) on page AppxG-39</i>
Cache Level ID	PMSA	<i>c0, Cache Level ID Register (CLIDR) on page B4-41</i>
	VMSA	<i>c0, Cache Level ID Register (CLIDR) on page B3-92</i>
Cache Lockdown, pre-ARMv7		<i>c9, cache lockdown support on page AppxH-52</i>
Cache Size ID	PMSA	<i>c0, Cache Size ID Registers (CCSIDR) on page B4-40</i>
	VMSA	<i>c0, Cache Size ID Registers (CCSIDR) on page B3-91</i>
Cache Type	PMSA	<i>c0, Cache Type Register (CTR) on page B4-34</i>
	VMSA	<i>c0, Cache Type Register (CTR) on page B3-83</i>
Cacheability, pre-ARMv6		<i>c2, Memory Region Cacheability Registers (DCR and ICR) on page AppxH-44</i>
CBOR, ARMv6 Security Extensions		<i>c9, Cache Behavior Override Register (CBOR) on page AppxG-49</i>
CCSIDR	PMSA	<i>c0, Cache Size ID Registers (CCSIDR) on page B4-40</i>
	VMSA	<i>c0, Cache Size ID Registers (CCSIDR) on page B3-91</i>
CDSR, ARMv6		<i>c7, Cache Dirty Status Register (CDSR) on page AppxG-39</i>
Claim Tag Clear		<i>Claim Tag Clear Register (DBGCLAIMCLR) on page C10-93</i>
Claim Tag Set		<i>Claim Tag Set Register (DBGCLAIMSET) on page C10-92</i>
CLIDR	PMSA	<i>c0, Cache Level ID Register (CLIDR) on page B4-41</i>
	VMSA	<i>c0, Cache Level ID Register (CLIDR) on page B3-92</i>
Component ID		<i>Debug Component Identification Registers (DBGCID0 to DBGCID3) on page C10-102</i>
Context ID	PMSA	<i>c13, Context ID Register (CONTEXTIDR) on page B4-76</i>
	VMSA	<i>c13, Context ID Register (CONTEXTIDR) on page B3-153</i>
Context ID Sampling, Debug		<i>Context ID Sampling Register (DBGCIDSR) on page C10-39</i>
CONTEXTIDR	PMSA	<i>c13, Context ID Register (CONTEXTIDR) on page B4-76</i>
	VMSA	<i>c13, Context ID Register (CONTEXTIDR) on page B3-153</i>

Table K-1 Register index (continued)

Register	In ^a	Description, see
Control	PMSA	<i>c1, System Control Register (SCTLR)</i> on page B4-45
	VMSA	<i>c1, System Control Register (SCTLR)</i> on page B3-96
Coprocessor Access Control	PMSA	<i>c1, Coprocessor Access Control Register (CPACR)</i> on page B4-51
	VMSA	<i>c1, Coprocessor Access Control Register (CPACR)</i> on page B3-104
Count Enable Clear		<i>c9, Count Enable Clear Register (PMCNTENCLR)</i> on page C10-109
Count Enable Set		<i>c9, Count Enable Set Register (PMCNTENSET)</i> on page C10-108
CPACR	PMSA	<i>c1, Coprocessor Access Control Register (CPACR)</i> on page B4-51
	VMSA	<i>c1, Coprocessor Access Control Register (CPACR)</i> on page B3-104
CPSR		<i>The Current Program Status Register (CPSR)</i> on page B1-14
CSSELR	PMSA	<i>c0, Cache Size Selection Register (CSSELR)</i> on page B4-43
	VMSA	<i>c0, Cache Size Selection Register (CSSELR)</i> on page B3-95
CTR	PMSA	<i>c0, Cache Type Register (CTR)</i> on page B4-34
	VMSA	<i>c0, Cache Type Register (CTR)</i> on page B3-83
Cycle Count		<i>c9, Cycle Count Register (PMCCNTR)</i> on page C10-114
D0 - D31		<i>Advanced SIMD and VFP extension registers</i> on page A2-21
DACR	VMSA	<i>c3, Domain Access Control Register (DACR)</i> on page B3-119
DAPR, pre-ARMv6		<i>c5, Memory Region Access Permissions Registers (DAPR and IAPR)</i> on page AppxH-45
Data Fault Address	PMSA	<i>c6, Data Fault Address Register (DFAR)</i> on page B4-57
	VMSA	<i>c6, Data Fault Address Register (DFAR)</i> on page B3-124
Data Fault Status	PMSA	<i>c5, Data Fault Status Register (DFSR)</i> on page B4-55
	VMSA	<i>c5, Data Fault Status Register (DFSR)</i> on page B3-121
Data Memory Region Access Permissions, pre-ARMv6		<i>c5, Memory Region Access Permissions Registers (DAPR and IAPR)</i> on page AppxH-45
Data Memory Region Bufferability, pre-ARMv6		<i>c3, Memory Region Bufferability Register (DBR)</i> on page AppxH-44

Table K-1 Register index (continued)

Register	In ^a	Description, see
Data Memory Region Cacheability, pre-ARMv6		<i>c2, Memory Region Cacheability Registers (DCR and ICR) on page AppxH-44</i>
Data Memory Region Extended Access Permissions, pre-ARMv6		<i>c5, Memory Region Extended Access Permissions Registers (DEAPR and IEAPR) on page AppxH-46</i>
Data or unified Cache Lockdown, pre-ARMv7		<i>c9, cache lockdown support on page AppxH-52</i>
Data or unified Memory Region, pre-ARMv6		<i>c6, Memory Region registers (DMRR0-DMRR7 and IMRR0-IMRR7) on page AppxH-47</i>
Data or unified TLB Lockdown, pre-ARMv7		<i>c10, VMSA TLB lockdown support on page AppxH-59</i>
Data Region Access Control	PMSA	<i>c6, Data Region Access Control Register (DRACR) on page B4-64</i>
Data Region Base Address	PMSA	<i>c6, Data Region Base Address Register (DRBAR) on page B4-60</i>
Data Region Size and Enable	PMSA	<i>c6, Data Region Size and Enable Register (DRSR) on page B4-62</i>
Data TCM Non-Secure Access Control, ARMv6		<i>c9, TCM Non-Secure Access Control Registers, DTCM-NSACR and ITCM-NSACR on page AppxG-51</i>
Data TCM Region, ARMv6		<i>c9, TCM Region Registers (DTCMRR and ITCMRR) on page AppxG-47</i>
Data Transfer, Debug		<i>Host to Target Data Transfer Register (DBGDTRRX) on page C10-40 Target to Host Data Transfer Register (DBGDTRTX) on page C10-43</i>
DBGAUTHSTATUS		<i>Authentication Status Register (DBGAUTHSTATUS) on page C10-96</i>
DBGBCR0 - DBGBCR15		<i>Breakpoint Control Registers (DBGBCR) on page C10-49</i>
DBGBVR0 - DBGBVR15		<i>Breakpoint Value Registers (DBGBVR) on page C10-48</i>
DBGCID0 - DBGCID3		<i>Debug Component Identification Registers (DBGCID0 to DBGCID3) on page C10-102</i>
DBGCIDSR		<i>Context ID Sampling Register (DBGCIDSR) on page C10-39</i>
DBGCLAIMCLR		<i>Claim Tag Clear Register (DBGCLAIMCLR) on page C10-93</i>
DBGCLAIMSET		<i>Claim Tag Set Register (DBGCLAIMSET) on page C10-92</i>
DBGDEVID		<i>Debug Device ID Register (DBGDEVID) on page C10-6.</i>
DBGDEVTYPE		<i>Device Type Register (DBGDEVTYPE) on page C10-98</i>

Table K-1 Register index (continued)

Register	In ^a	Description, see
DBGDIDR		<i>Debug ID Register (DBGDIDR) on page C10-3</i>
DBGDRAR		<i>Debug ROM Address Register (DBGDRAR) on page C10-7</i>
DBGDRCR		<i>Debug Run Control Register (DBGDRCR), v7 Debug only on page C10-29</i>
DBGDSAR		<i>Debug Self Address Offset Register (DBGDSAR) on page C10-8</i>
DBGDSCCR		<i>Debug State Cache Control Register (DBGDSCCR) on page C10-81</i>
DBGDSCR		<i>Debug Status and Control Register (DBGDSCR) on page C10-10</i>
DBGDSCRext		<i>Internal and external views of the DBGDSCR and the DCC registers on page C6-21</i>
DBGDSCRint		<i>Internal and external views of the DBGDSCR and the DCC registers on page C6-21</i>
DBGDSMCR		<i>Debug State MMU Control Register (DBGDSMCR) on page C10-84</i>
DBGDTRRX		<i>Host to Target Data Transfer Register (DBGDTRRX) on page C10-40</i>
DBGDTRRXext		<i>Internal and external views of the DBGDSCR and the DCC registers on page C6-21</i>
DBGDTRRXint		<i>Internal and external views of the DBGDSCR and the DCC registers on page C6-21</i>
DBGDTRTX		<i>Target to Host Data Transfer Register (DBGDTRTX) on page C10-43</i>
DBGDTRTXext		<i>Internal and external views of the DBGDSCR and the DCC registers on page C6-21</i>
DBGDTRTXint		<i>Internal and external views of the DBGDSCR and the DCC registers on page C6-21</i>
DBGECR		<i>Event Catch Register (DBGECR) on page C10-78</i>
DBGITCTRL		<i>Integration Mode Control Register (DBGITCTRL) on page C10-91</i>
DBGITR		<i>Instruction Transfer Register (DBGITR) on page C10-46</i>
DBGLAR		<i>Lock Access Register (DBGLAR) on page C10-94</i>
DBGLSR		<i>Lock Status Register (DBGLSR) on page C10-95</i>
DBGOSLAR		<i>OS Lock Access Register (DBGOSLAR) on page C10-75</i>

Table K-1 Register index (continued)

Register	In ^a	Description, see
DBGOSLSR		<i>OS Lock Status Register (DBGOSLSR) on page C10-76</i>
DBGOSSRR		<i>OS Save and Restore Register (DBGOSSRR) on page C10-77</i>
DBGPCSR		<i>Program Counter Sampling Register (DBGPCSR) on page C10-38</i>
DBGPID0 - DBGPID4		<i>Debug Peripheral Identification Registers (DBGPID0 to DBGPID4) on page C10-98</i>
DBGPRCR		<i>Device Power-down and Reset Control Register (DBGPRCR), v7 Debug only on page C10-31</i>
DBGPRSR		<i>Device Power-down and Reset Status Register (DBGPRSR), v7 Debug only on page C10-34</i>
DBGVCR		<i>Vector Catch Register (DBGVCR) on page C10-67</i>
DBGWCR0 - DBGWCR15		<i>Watchpoint Control Registers (DBGWCR) on page C10-61</i>
DBGWFAR, CP14		<i>Watchpoint Fault Address Register (DBGWFAR) on page C10-28</i>
DBGWFAR, CP15, ARMv6		<i>c6, Watchpoint Fault Address Register (DBGWFAR) on page AppxG-37</i>
DBGWVR0 - DBGWVR15		<i>Watchpoint Value Registers (DBGWVR) on page C10-60</i>
DBR, pre-ARMv6		<i>c3, Memory Region Bufferability Register (DBR) on page AppxH-44</i>
DCC		<i>Internal and external views of the DBGDSCR and the DCC registers on page C6-21</i>
DCCIMVAC	PMSA	<i>CP15 c7, Cache and branch predictor maintenance functions on page B4-68</i>
	VMSA	<i>CP15 c7, Cache and branch predictor maintenance functions on page B3-126</i>
DCCISW	PMSA	<i>CP15 c7, Cache and branch predictor maintenance functions on page B4-68</i>
	VMSA	<i>CP15 c7, Cache and branch predictor maintenance functions on page B3-126</i>
DCCMVAC	PMSA	<i>CP15 c7, Cache and branch predictor maintenance functions on page B4-68</i>
	VMSA	<i>CP15 c7, Cache and branch predictor maintenance functions on page B3-126</i>

Table K-1 Register index (continued)

Register	In ^a	Description, see
DCCMVAU	PMSA	<i>CP15 c7, Cache and branch predictor maintenance functions on page B4-68</i>
	VMSA	<i>CP15 c7, Cache and branch predictor maintenance functions on page B3-126</i>
DCCSW	PMSA	<i>CP15 c7, Cache and branch predictor maintenance functions on page B4-68</i>
	VMSA	<i>CP15 c7, Cache and branch predictor maintenance functions on page B3-126</i>
DCIMVAC	PMSA	<i>CP15 c7, Cache and branch predictor maintenance functions on page B4-68</i>
	VMSA	<i>CP15 c7, Cache and branch predictor maintenance functions on page B3-126</i>
DCISW	PMSA	<i>CP15 c7, Cache and branch predictor maintenance functions on page B4-68</i>
	VMSA	<i>CP15 c7, Cache and branch predictor maintenance functions on page B3-126</i>
DCLR, pre-ARMv7		<i>c9, cache lockdown support on page AppxH-52</i>
DCLR2, pre-ARMv7		<i>c9, Format D Data or unified Cache Lockdown Register, DCLR2 on page AppxH-58</i>
DCR, pre-ARMv6		<i>c2, Memory Region Cacheability Registers (DCR and ICR) on page AppxH-44</i>
DEAPR, pre-ARMv6		<i>c5, Memory Region Extended Access Permissions Registers (DEAPR and IEAPR) on page AppxH-46</i>
Debug Component ID		<i>Debug Component Identification Registers (DBGCID0 to DBGCID3) on page C10-102</i>
Debug Context ID Sampling		<i>Context ID Sampling Register (DBGCIDSR) on page C10-39</i>
Debug Device ID		<i>Debug Device ID Register (DBGDEVID) on page C10-6.</i>
Debug Feature 0		<i>c0, Debug Feature Register 0 (ID_DFR0) on page B5-6</i>
Debug ID		<i>Debug ID Register (DBGDIDR) on page C10-3</i>

Table K-1 Register index (continued)

Register	In ^a	Description, see
Debug Peripheral ID		<i>Debug Peripheral Identification Registers (DBGPID0 to DBGPID4)</i> on page C10-98
Debug Program Counter Sampling		<i>Program Counter Sampling Register (DBGPCSR)</i> on page C10-38
Debug ROM Address		<i>Debug ROM Address Register (DBGDRAR)</i> on page C10-7
Debug Run Control		<i>Debug Run Control Register (DBGDRCR)</i> , v7 <i>Debug only</i> on page C10-29
Debug Self Address Offset		<i>Debug Self Address Offset Register (DBGDSAR)</i> on page C10-8
Debug State Cache Control		<i>Debug State Cache Control Register (DBGDSCCR)</i> on page C10-81
Debug State MMU Control		<i>Debug State MMU Control Register (DBGDSMCR)</i> on page C10-84
Debug Status and Control		<i>Debug Status and Control Register (DBGDSCR)</i> on page C10-10
Device ID, Debug		<i>Debug Device ID Register (DBGDEVID)</i> on page C10-6
Device Power-down and Reset Control		<i>Device Power-down and Reset Control Register (DBGPRCR)</i> , v7 <i>Debug only</i> on page C10-31
Device Power-down and Reset Status		<i>Device Power-down and Reset Status Register (DBGPRSR)</i> , v7 <i>Debug only</i> on page C10-34
Device Type, Debug		<i>Device Type Register (DBGDEVTYPE)</i> on page C10-98
DFAR	PMSA	<i>c6, Data Fault Address Register (DFAR)</i> on page B4-57
	VMSA	<i>c6, Data Fault Address Register (DFAR)</i> on page B3-124
DFSR	PMSA	<i>c5, Data Fault Status Register (DFSR)</i> on page B4-55
	VMSA	<i>c5, Data Fault Status Register (DFSR)</i> on page B3-121
DMRR0-DMRR7, pre-ARMv6		<i>c6, Memory Region registers (DMRR0-DMRR7 and IMRR0-IMRR7)</i> on page AppxH-47
Domain Access Control	VMSA	<i>c3, Domain Access Control Register (DACR)</i> on page B3-119
DRACR	PMSA	<i>c6, Data Region Access Control Register (DRACR)</i> on page B4-64
DRBAR	PMSA	<i>c6, Data Region Base Address Register (DRBAR)</i> on page B4-60
DRSR	PMSA	<i>c6, Data Region Size and Enable Register (DRSR)</i> on page B4-62
DTCM-NSACR, ARMv6		<i>c9, TCM Non-Secure Access Control Registers, DTCM-NSACR and ITCM-NSACR</i> on page AppxG-51

Table K-1 Register index (continued)

Register	In ^a	Description, see
DTCMRR, ARMv6		<i>c9, TCM Region Registers (DTCMRR and ITCMRR) on page AppxG-47</i>
DTLBIALL	VMSA	<i>CP15 c8, TLB maintenance operations on page B3-138</i>
DTLBIASID	VMSA	<i>CP15 c8, TLB maintenance operations on page B3-138</i>
DTLBIMVA	VMSA	<i>CP15 c8, TLB maintenance operations on page B3-138</i>
DTLBLR, pre-ARMv7		<i>c10, VMSA TLB lockdown support on page AppxH-59</i>
ENDIANSTATE		<i>ENDIANSTATE on page A2-19</i>
Event		<i>The Event Register on page B1-46</i>
Event Catch		<i>Event Catch Register (DBGECR) on page C10-78</i>
Event Count		<i>c9, Event Count Register (PMXEVCNTR) on page C10-116</i>
Event Counter Selection		<i>c9, Event Counter Selection Register (PMSELR) on page C10-113</i>
Event Select		<i>c9, Event Type Select Register (PMXEVTYPER) on page C10-115</i>
Extended Access Permissions, pre-ARMv6		<i>c5, Memory Region Extended Access Permissions Registers (DEAPR and IEAPR) on page AppxH-46</i>
FAR		<i>See Fault Address</i>
Fault Address		<i>c6, Data Fault Address Register (DFAR) on page B4-57 (PMSA) c6, Data Fault Address Register (DFAR) on page B3-124 (VMSA) c6, Instruction Fault Address Register (IFAR) on page B4-58 (PMSA) c6, Instruction Fault Address Register (IFAR) on page B3-125 (VMSA) Watchpoint Fault Address Register (DBGWFAR) on page C10-28 c6, Watchpoint Fault Address Register (DBGWFAR) on page AppxG-37 (ARMv6)</i>
Fault Status	PMSA	<i>c5, Data Fault Status Register (DFSR) on page B4-55 c5, Instruction Fault Status Register (IFSR) on page B4-56</i>
	VMSA	<i>c5, Data Fault Status Register (DFSR) on page B3-121 c5, Instruction Fault Status Register (IFSR) on page B3-122</i>
FCSE Process ID	VMSA	<i>c13, FCSE Process ID Register (FCSEIDR) on page B3-152</i>
FCSEIDR	VMSA	<i>c13, FCSE Process ID Register (FCSEIDR) on page B3-152</i>
Floating-point Exception		<i>The Floating-Point Exception Register (FPEXC) on page B1-68</i>

Table K-1 Register index (continued)

Register	In ^a	Description, see
Floating-point Instruction		<i>The Floating-Point Instruction Registers, FPINST and FPINST2 on page AppxB-20</i>
Floating-point System ID		<i>Floating-point System ID Register (FPSID) on page B5-34</i>
Format D Data Cache Lockdown, pre-ARMv7		<i>c9, Format D Data or unified Cache Lockdown Register, DCLR2 on page AppxH-58</i>
FPEXC		<i>The Floating-Point Exception Register (FPEXC) on page B1-68</i>
FPINST		<i>The Floating-Point Instruction Registers, FPINST and FPINST2 on page AppxB-20</i>
FPINST2		<i>The Floating-Point Instruction Registers, FPINST and FPINST2 on page AppxB-20</i>
FPSCR		<i>Floating-point Status and Control Register (FPSCR) on page A2-28</i>
FPSID		<i>Floating-point System ID Register (FPSID) on page B5-34</i>
FSR		<i>See Fault Status</i>
Host to Target Data Transfer		<i>Host to Target Data Transfer Register (DBGDTRRX) on page C10-40</i>
IAPR, pre-ARMv6		<i>c5, Memory Region Access Permissions Registers (DAPR and IAPR) on page AppxH-45</i>
ICIALLU	PMSA	<i>CP15 c7, Cache and branch predictor maintenance functions on page B4-68</i>
	VMSA	<i>CP15 c7, Cache and branch predictor maintenance functions on page B3-126</i>
ICIALUIS	PMSA	<i>CP15 c7, Cache and branch predictor maintenance functions on page B4-68</i>
	VMSA	<i>CP15 c7, Cache and branch predictor maintenance functions on page B3-126</i>
ICIMVAU	PMSA	<i>CP15 c7, Cache and branch predictor maintenance functions on page B4-68</i>
	VMSA	<i>CP15 c7, Cache and branch predictor maintenance functions on page B3-126</i>
ICLR, pre-ARMv7		<i>c9, cache lockdown support on page AppxH-52</i>

Table K-1 Register index (continued)

Register	In ^a	Description, see
ICR, pre-ARMv6		<i>c2, Memory Region Cacheability Registers (DCR and ICR) on page AppxH-44</i>
ID_AFR0		<i>c0, Auxiliary Feature Register 0 (ID_AFR0) on page B5-8</i>
ID_DFR0		<i>c0, Debug Feature Register 0 (ID_DFR0) on page B5-6</i>
ID_ISAR0		<i>c0, Instruction Set Attribute Register 0 (ID_ISAR0) on page B5-24</i>
ID_ISAR1		<i>c0, Instruction Set Attribute Register 1 (ID_ISAR1) on page B5-25</i>
ID_ISAR2		<i>c0, Instruction Set Attribute Register 2 (ID_ISAR2) on page B5-27</i>
ID_ISAR3		<i>c0, Instruction Set Attribute Register 3 (ID_ISAR3) on page B5-29</i>
ID_ISAR4		<i>c0, Instruction Set Attribute Register 4 (ID_ISAR4) on page B5-31</i>
ID_ISAR5		<i>c0, Instruction Set Attribute Register 5 (ID_ISAR5) on page B5-33</i>
ID_MMFR0		<i>c0, Memory Model Feature Register 0 (ID_MMFR0) on page B5-9</i>
ID_MMFR1		<i>c0, Memory Model Feature Register 1 (ID_MMFR1) on page B5-11</i>
ID_MMFR2		<i>c0, Memory Model Feature Register 2 (ID_MMFR2) on page B5-14</i>
ID_MMFR3		<i>c0, Memory Model Feature Register 3 (ID_MMFR3) on page B5-17</i>
ID_PFR0		<i>c0, Processor Feature Register 0 (ID_PFR0) on page B5-4</i>
ID_PFR1		<i>c0, Processor Feature Register 1 (ID_PFR1) on page B5-5</i>
ID, Debug		<i>Debug ID Register (DBGDIDR) on page C10-3</i>
IEAPR, pre-ARMv6		<i>c5, Memory Region Extended Access Permissions Registers (DEAPR and IEAPR) on page AppxH-46</i>
IFAR	PMSA	<i>c6, Instruction Fault Address Register (IFAR) on page B4-58</i>
	VMSA	<i>c6, Instruction Fault Address Register (IFAR) on page B3-125</i>
IFSR	PMSA	<i>c5, Instruction Fault Status Register (IFSR) on page B4-56</i>
	VMSA	<i>c5, Instruction Fault Status Register (IFSR) on page B3-122</i>
IMRR0-IMRR7, pre-ARMv6		<i>c6, Memory Region registers (DMRR0-DMRR7 and IMRR0-IMRR7) on page AppxH-47</i>
Instruction Cache Lockdown, pre-ARMv7		<i>c9, cache lockdown support on page AppxH-52</i>

Table K-1 Register index (continued)

Register	In ^a	Description, see
Instruction Fault Address	PMSA	<i>c6, Instruction Fault Address Register (IFAR) on page B4-58</i>
	VMSA	<i>c6, Instruction Fault Address Register (IFAR) on page B3-125</i>
Instruction Fault Status	PMSA	<i>c5, Instruction Fault Status Register (IFSR) on page B4-56</i>
	VMSA	<i>c5, Instruction Fault Status Register (IFSR) on page B3-122</i>
Instruction Memory Region Cacheability, pre-ARMv6		<i>c2, Memory Region Cacheability Registers (DCR and ICR) on page AppxH-44</i>
Instruction Memory Region Extended Access Permissions, pre-ARMv6		<i>c5, Memory Region Extended Access Permissions Registers (DEAPR and IEAPR) on page AppxH-46</i>
Instruction Memory Region, pre-ARMv6		<i>c6, Memory Region registers (DMRR0-DMRR7 and IMRR0-IMRR7) on page AppxH-47</i>
Instruction Memory Region Access Permissions, pre-ARMv6		<i>c5, Memory Region Access Permissions Registers (DAPR and IAPR) on page AppxH-45</i>
Instruction Region Access Control	PMSA	<i>c6, Instruction Region Access Control Register (IRACR) on page B4-65</i>
Instruction Region Base Address	PMSA	<i>c6, Instruction Region Base Address Register (IRBAR) on page B4-61</i>
Instruction Region Size and Enable	PMSA	<i>c6, Instruction Region Size and Enable Register (IRSR) on page B4-63</i>
Instruction Set Attribute		<i>CP15 c0, Instruction Set Attribute registers on page B5-19</i>
Instruction TCM Non-Secure Access Control, ARMv6		<i>c9, TCM Non-Secure Access Control Registers, DTCM-NSACR and ITCM-NSACR on page AppxG-51</i>
Instruction TCM Region, ARMv6		<i>c9, TCM Region Registers (DTCMRR and ITCMRR) on page AppxG-47</i>
Instruction TLB Lockdown Register, pre-ARMv7		<i>c10, VMSA TLB lockdown support on page AppxH-59</i>
Instruction Transfer Register, Debug		<i>Instruction Transfer Register (DBGITR) on page C10-46</i>
Integration Mode Control		<i>Integration Mode Control Register (DBGITCTRL) on page C10-91</i>
Interrupt Enable Clear		<i>c9, Interrupt Enable Clear Register (PMINTENCLR) on page C10-119</i>
Interrupt Enable Set		<i>c9, Interrupt Enable Set Register (PMINTENSET) on page C10-118</i>
Interrupt Status	VMSA	<i>c12, Interrupt Status Register (ISR) on page B3-150</i>

Table K-1 Register index (continued)

Register	In ^a	Description, see
IRACR	PMSA	<i>c6, Instruction Region Access Control Register (IRACR) on page B4-65</i>
IRBAR	PMSA	<i>c6, Instruction Region Base Address Register (IRBAR) on page B4-61</i>
IRSR	PMSA	<i>c6, Instruction Region Size and Enable Register (IRSR) on page B4-63</i>
ISSETSTATE		<i>ISSETSTATE on page A2-15</i>
ISR	VMSA	<i>c12, Interrupt Status Register (ISR) on page B3-150</i>
ITCM-NSACR, ARMv6		<i>c9, TCM Non-Secure Access Control Registers, DTCM-NSACR and ITCM-NSACR on page AppxG-51</i>
ITCMRR, ARMv6		<i>c9, TCM Region Registers (DTCMRR and ITCMRR) on page AppxG-47</i>
ITLBIALL	VMSA	<i>CP15 c8, TLB maintenance operations on page B3-138</i>
ITLBIASID	VMSA	<i>CP15 c8, TLB maintenance operations on page B3-138</i>
ITLBIMVA	VMSA	<i>CP15 c8, TLB maintenance operations on page B3-138</i>
ITLBLR, pre-ARMv7		<i>c10, VMSA TLB lockdown support on page AppxH-59</i>
ITSTATE		<i>ITSTATE on page A2-17</i>
Jazelle ID		<i>Jazelle ID Register (JIDR) on page A2-76</i>
Jazelle Main Configuration		<i>Jazelle Main Configuration Register (JMCR) on page A2-77</i>
Jazelle OS Control		<i>Jazelle OS Control Register (JOSCR) on page B1-77</i>
JIDR		<i>Jazelle ID Register (JIDR) on page A2-76</i>
JMCR		<i>Jazelle Main Configuration Register (JMCR) on page A2-77</i>
JOSCR		<i>Jazelle OS Control Register (JOSCR) on page B1-77</i>
Lock Access		<i>Lock Access Register (DBGLAR) on page C10-94</i>
Lock Status		<i>Lock Status Register (DBGLSR) on page C10-95</i>
LR		<i>ARM core registers on page A2-11 for application-level description ARM core registers on page B1-9 for system-level description</i>
LR_abt, LR_fiq, LR_irq, LR_mon, LR_svc, LR_und, LR_usr		<i>ARM core registers on page B1-9</i>

Table K-1 Register index (continued)

Register	In ^a	Description, see
Main ID	PMSA	<i>c0, Main ID Register (MIDR) on page B4-32</i>
	VMSA	<i>c0, Main ID Register (MIDR) on page B3-81</i>
Media and VFP Feature		<i>Media and VFP Feature registers on page B5-36</i>
Memory Model Feature		<i>CP15 c0, Memory Model Feature registers on page B5-9</i>
Memory Region Access Permissions, pre-ARMv6		<i>c5, Memory Region Access Permissions Registers (DAPR and IAPR) on page AppxH-45</i>
Memory Region Bufferability, pre-ARMv6		<i>c3, Memory Region Bufferability Register (DBR) on page AppxH-44</i>
Memory Region Cacheability, pre-ARMv6		<i>c2, Memory Region Cacheability Registers (DCR and ICR) on page AppxH-44</i>
Memory Region, pre-ARMv6		<i>c6, Memory Region registers (DMRR0-DMRR7 and IMRR0-IMRR7) on page AppxH-47</i>
Memory Remap	VMSA	<i>CP15 c10, Memory Remap Registers on page B3-143</i>
MIDR	PMSA	<i>c0, Main ID Register (MIDR) on page B4-32</i>
	VMSA	<i>c0, Main ID Register (MIDR) on page B3-81</i>
Monitor Vector Base Address	VMSA	<i>c12, Monitor Vector Base Address Register (MVBAR) on page B3-149</i>
MPIDR	PMSA	<i>c0, Multiprocessor Affinity Register (MPIDR) on page B4-37</i>
	VMSA	<i>c0, Multiprocessor Affinity Register (MPIDR) on page B3-87</i>
MPU Region Number	PMSA	<i>c6, MPU Region Number Register (RGNR) on page B4-66</i>
MPU Type	PMSA	<i>c0, MPU Type Register (MPUIR) on page B4-36</i>
MPUIR	PMSA	<i>c0, MPU Type Register (MPUIR) on page B4-36</i>
Multiprocessor affinity	PMSA	<i>c0, Multiprocessor Affinity Register (MPIDR) on page B4-37</i>
	VMSA	<i>c0, Multiprocessor Affinity Register (MPIDR) on page B3-87</i>
MVBAR	VMSA	<i>c12, Monitor Vector Base Address Register (MVBAR) on page B3-149</i>
MVFR0		<i>Media and VFP Feature Register 0 (MVFR0) on page B5-36</i>
MVFR1		<i>Media and VFP Feature Register 1 (MVFR1) on page B5-38</i>

Table K-1 Register index (continued)

Register	In ^a	Description, see
NMRR	VMSA	<i>c10, Normal Memory Remap Register (NMRR)</i> on page B3-146
Non-secure Access Control	VMSA	<i>c1, Non-Secure Access Control Register (NSACR)</i> on page B3-110
Non-Secure Access Control, ARMv6 differences		<i>c1, VMSA Security Extensions support</i> on page AppxG-35
Normal Memory Remap	VMSA	<i>c10, Normal Memory Remap Register (NMRR)</i> on page B3-146
NSACR	VMSA	<i>c1, Non-Secure Access Control Register (NSACR)</i> on page B3-110
	ARMv6	<i>c9, TCM Non-Secure Access Control Registers, DTCM-NSACR and ITCM-NSACR</i> on page AppxG-51
OS Lock Access		<i>OS Lock Access Register (DBGOSLAR)</i> on page C10-75
OS Lock Status		<i>OS Lock Status Register (DBGOSLSR)</i> on page C10-76
OS Save and Restore		<i>OS Save and Restore Register (DBGOSSRR)</i> on page C10-77
Overflow Flag Status		<i>c9, Overflow Flag Status Register (PMOVSRR)</i> on page C10-110
PAR	VMSA	<i>c7, Physical Address Register (PAR) and VA to PA translations</i> on page B3-133
PC		<i>ARM core registers</i> on page A2-11 for application-level description <i>ARM core registers</i> on page B1-9 for system-level description
Performance Monitor Control		<i>c9, Performance Monitor Control Register (PMCR)</i> on page C10-105
Peripheral ID		<i>Debug Peripheral Identification Registers (DBGPID0 to DBGPID4)</i> on page C10-98
PFF	PMSA	<i>Instruction Synchronization Barrier operation</i> on page B4-73
	VMSA	<i>Instruction Synchronization Barrier operation</i> on page B3-137
Physical Address	VMSA	<i>c7, Physical Address Register (PAR) and VA to PA translations</i> on page B3-133
PMCCNTR		<i>c9, Cycle Count Register (PMCCNTR)</i> on page C10-114
PMCNTENCLR		<i>c9, Count Enable Clear Register (PMCNTENCLR)</i> on page C10-109
PMCNTENSET		<i>c9, Count Enable Set Register (PMCNTENSET)</i> on page C10-108
PMCR		<i>c9, Performance Monitor Control Register (PMCR)</i> on page C10-105

Table K-1 Register index (continued)

Register	In ^a	Description, see
PMINTENCLR		<i>c9, Interrupt Enable Clear Register (PMINTENCLR) on page C10-119</i>
PMINTENSET		<i>c9, Interrupt Enable Set Register (PMINTENSET) on page C10-118</i>
PMOVSr		<i>c9, Overflow Flag Status Register (PMOVSr) on page C10-110</i>
PMSELr		<i>c9, Event Counter Selection Register (PMSELr) on page C10-113</i>
PMSWINC		<i>c9, Software Increment Register (PMSWINC) on page C10-112</i>
PMUSERENR		<i>c9, User Enable Register (PMUSERENR) on page C10-117</i>
PMXEVCNTR		<i>c9, Event Count Register (PMXEVCNTR) on page C10-116</i>
PMXEVTYPER		<i>c9, Event Type Select Register (PMXEVTYPER) on page C10-115</i>
Power-down and Reset Control		<i>Device Power-down and Reset Control Register (DBGPRCR), v7 Debug only on page C10-31</i>
Power-down and Reset Status		<i>Device Power-down and Reset Status Register (DBGPRSR), v7 Debug only on page C10-34</i>
Prefetch Status, ARMv6		<i>c7, Block Transfer Status Register on page AppxG-43</i>
Primary Region Remap	VMSA	<i>c10, Primary Region Remap Register (PRRR) on page B3-143</i>
Processor Feature		<i>CP15 c0, Processor Feature registers on page B5-4</i>
Program Counter Sampling, Debug		<i>Program Counter Sampling Register (DBGPCSR) on page C10-38</i>
PRRR	VMSA	<i>c10, Primary Region Remap Register (PRRR) on page B3-143</i>
PSR		<i>Program Status Registers (PSRs) on page B1-14</i>
Q0 - Q15		<i>Advanced SIMD and VFP extension registers on page A2-21</i>
R0 - R15		<i>ARM core registers on page A2-11 for application-level description ARM core registers on page B1-9 for system-level description</i>
R0_usr - R12_usr		<i>ARM core registers on page B1-9</i>
R8_fiq - R12_fiq		<i>ARM core registers on page B1-9</i>
RGNR	PMSA	<i>c6, MPU Region Number Register (RGNR) on page B4-66</i>
Run Control, Debug		<i>Debug Run Control Register (DBGDRCR), v7 Debug only on page C10-29</i>
S0 - S31		<i>Advanced SIMD and VFP extension registers on page A2-21</i>

Table K-1 Register index (continued)

Register	In ^a	Description, see
SCR	VMSA	<i>c1</i> , Secure Configuration Register (SCR) on page B3-106
SCTLR	PMSA	<i>c1</i> , System Control Register (SCTLR) on page B4-45
	VMSA	<i>c1</i> , System Control Register (SCTLR) on page B3-96
SDER	VMSA	<i>c1</i> , Secure Debug Enable Register (SDER) on page B3-108
Secure Configuration	VMSA	<i>c1</i> , Secure Configuration Register (SCR) on page B3-106
Secure Debug Enable	VMSA	<i>c1</i> , Secure Debug Enable Register (SDER) on page B3-108
Software Increment		<i>c9</i> , Software Increment Register (PMSWINC) on page C10-112
Software Thread ID	PMSA	CP15 <i>c13</i> Software Thread ID registers on page B4-77
	VMSA	CP15 <i>c13</i> Software Thread ID registers on page B3-154
SP		ARM core registers on page A2-11 for application-level description ARM core registers on page B1-9 for system-level description
SP-_abt, SP_fiq, SP_irq, SP_mon, SP-_svc, SP-_und, SP_usr		ARM core registers on page B1-9
SPSR		The Saved Program Status Registers (SPSRs) on page B1-15
SPSR_abt, SPSR_fiq, SPSR_irq, SPSR_mon, SPSR-_svc, SPSR-_und		ARM core registers on page B1-9
System Control	PMSA	CP15 <i>c1</i> , System control registers on page B4-44
System Control	VMSA	CP15 <i>c1</i> , System control registers on page B3-96
Target to Host Data Transfer		Target to Host Data Transfer Register (DBGDTRTX) on page C10-43
TCM Data Region, ARMv6		<i>c9</i> , TCM Region Registers (DTCMRR and ITCMRR) on page AppxG-47
TCM Instruction or unified Region, ARMv6		<i>c9</i> , TCM Region Registers (DTCMRR and ITCMRR) on page AppxG-47
TCM Non-Secure Access Control, ARMv6		<i>c9</i> , TCM Non-Secure Access Control Registers, DTCM-NSACR and ITCM-NSACR on page AppxG-51
TCM Selection, ARMv6		<i>c9</i> , TCM Selection Register (TCMSR) on page AppxG-46
TCM Type	PMSA	<i>c0</i> , TCM Type Register (TCMTR) on page B4-35
	VMSA	<i>c0</i> , TCM Type Register (TCMTR) on page B3-85

Table K-1 Register index (continued)

Register	In ^a	Description, see
TCMSR, ARMv6		<i>c9, TCM Selection Register (TCMSR) on page AppxG-46</i>
TCMTR	PMSA	<i>c0, TCM Type Register (TCMTR) on page B4-35</i>
	VMSA	<i>c0, TCM Type Register (TCMTR) on page B3-85</i>
TEECR		<i>ThumbEE Configuration Register (TEECR) on page A2-70</i>
TEEHBR		<i>ThumbEE Handler Base Register (TEEHBR) on page A2-71</i>
TEX Remap	VMSA	<i>CP15 c10, Memory Remap Registers on page B3-143</i>
ThumbEE Configuration		<i>ThumbEE Configuration Register (TEECR) on page A2-70</i>
ThumbEE Handler Base		<i>ThumbEE Handler Base Register (TEEHBR) on page A2-71</i>
TLB Lockdown Register, pre-ARMv7		<i>c10, VMSA TLB lockdown support on page AppxH-59</i>
TLB Type	VMSA	<i>c0, TLB Type Register (TLBTR) on page B3-86</i>
TLBIALL	VMSA	<i>CP15 c8, TLB maintenance operations on page B3-138</i>
TLBIALLIS	VMSA	<i>CP15 c8, TLB maintenance operations on page B3-138</i>
TLBIASID	VMSA	<i>CP15 c8, TLB maintenance operations on page B3-138</i>
TLBIASIDIS	VMSA	<i>CP15 c8, TLB maintenance operations on page B3-138</i>
TLBIMVA	VMSA	<i>CP15 c8, TLB maintenance operations on page B3-138</i>
TLBIMVAA	VMSA	<i>CP15 c8, TLB maintenance operations on page B3-138</i>
TLBIMVAAIS	VMSA	<i>CP15 c8, TLB maintenance operations on page B3-138</i>
TLBIMVAIS	VMSA	<i>CP15 c8, TLB maintenance operations on page B3-138</i>
TLBTR		<i>c0, TLB Type Register (TLBTR) on page B3-86</i>
TPIDRPRW	PMSA	<i>CP15 c13 Software Thread ID registers on page B4-77</i>
	VMSA	<i>CP15 c13 Software Thread ID registers on page B3-154</i>
TPIDRURO	PMSA	<i>CP15 c13 Software Thread ID registers on page B4-77</i>
	VMSA	<i>CP15 c13 Software Thread ID registers on page B3-154</i>
TPIDRURW	PMSA	<i>CP15 c13 Software Thread ID registers on page B4-77</i>
	VMSA	<i>CP15 c13 Software Thread ID registers on page B3-154</i>

Table K-1 Register index (continued)

Register	In ^a	Description, see
Translation Table Base	VMSA	CP15 c2, Translation table support registers on page B3-113
TTBCR	VMSA	c2, Translation Table Base Control Register (TTBCR) on page B3-117
TTBR0	VMSA	c2, Translation Table Base Register 0 (TTBR0) on page B3-113
TTBR1	VMSA	c2, Translation Table Base Register 1 (TTBR1) on page B3-116
User Enable		c9, User Enable Register (PMUSERENR) on page C10-117
UTLBIALL	VMSA	
UTLBIASID	VMSA	Previous names for the CP15 c8 operations TLBIALL, TLBIASID, and TLBIMVA, see CP15 c8, TLB maintenance operations on page B3-138
UTLBIMVA	VMSA	
V2PCWPR	VMSA	CP15 c7, Virtual Address to Physical Address translation operations on page B3-130
V2PCWPW	VMSA	CP15 c7, Virtual Address to Physical Address translation operations on page B3-130
V2PCWUR	VMSA	CP15 c7, Virtual Address to Physical Address translation operations on page B3-130
V2PCWUW	VMSA	CP15 c7, Virtual Address to Physical Address translation operations on page B3-130
V2POWPR	VMSA	CP15 c7, Virtual Address to Physical Address translation operations on page B3-130
V2POWPW	VMSA	CP15 c7, Virtual Address to Physical Address translation operations on page B3-130
V2POWUR	VMSA	CP15 c7, Virtual Address to Physical Address translation operations on page B3-130
V2POWUW	VMSA	CP15 c7, Virtual Address to Physical Address translation operations on page B3-130
VBAR	VMSA	c12, Vector Base Address Register (VBAR) on page B3-148
Vector Base Address	VMSA	c12, Vector Base Address Register (VBAR) on page B3-148
Vector Catch Register		Vector Catch Register (DBGVCR) on page C10-67
Watchpoint Control		Watchpoint Control Registers (DBGWCR) on page C10-61

Table K-1 Register index (continued)

Register	In ^a	Description, see
Watchpoint Fault Address, CP14		<i>Watchpoint Fault Address Register (DBGWFAR)</i> on page C10-28
Watchpoint Fault Address, CP15, ARMv6		<i>c6, Watchpoint Fault Address Register (DBGWFAR)</i> on page AppxG-37
Watchpoint Value		<i>Watchpoint Value Registers (DBGWVR)</i> on page C10-60

- a. Applies only to entries for ARMv7 CP15 registers and operations. Where these are included in both a VMSA implementation and a PMSA implementation these are described in Chapter B3 *Virtual Memory System Architecture (VMSA)* and in Chapter B4 *Protected Memory System Architecture (PMSA)*, and both descriptions are included in this index.

Glossary

Abort Is caused by an illegal memory access. Aborts can be caused by the external memory system or the MMU or MPU.

Abort model

Describes what happens to the processor state when a Data Abort exception occurs. Different abort models behave differently with regard to load/store instructions that specify base register write-back. For more details, see *Effects of data-aborted instructions* on page B1-57.

Addressing mode

Means a method for generating the memory address used by a load/store instruction.

Advanced SIMD

Is an extension to the ARM architecture that provides SIMD operations on a bank of extension registers. If the VFP extension is also implemented, the two extensions share the register bank and the SIMD operations include single-precision floating-point SIMD operations.

Aligned Refers to data items stored in such a way that their address is divisible by the highest power of 2 that divides their size. Aligned halfwords, words and doublewords therefore have addresses that are divisible by 2, 4 and 8 respectively.

An aligned access is one where the address of the access is aligned to the size of an element of the access

ARM instruction

Is a word that specifies an operation for a processor in ARM state to perform. ARM instructions must be word-aligned.

Atomicity

Is a term that describes either single-copy atomicity or multi-copy atomicity. The forms of atomicity used in the ARM architecture are defined in *Atomicity in the ARM architecture* on page A3-26.

See also Multi-copy Atomicity, Single-copy atomicity.

Banked register

Is a register that has multiple instances, with the instance that is in use depending on the processor mode, security state, or other processor state.

Base register

Is a register specified by a load/store instruction that is used as the base value for the instruction's address calculation. Depending on the instruction and its addressing mode, an offset can be added to or subtracted from the base register value to form the virtual address that is sent to memory.

Base register write-back

Describes writing back a modified value to the base register used in an address calculation.

Big-endian memory

Means that:

- a byte or halfword at a word-aligned address is the most significant byte or halfword in the word at that address
- a byte at a halfword-aligned address is the most significant byte in the halfword at that address.

Blocking

Describes an operation that does not permit following instructions to be executed before the operation is completed.

A non-blocking operation can permit following instructions to be executed before the operation is completed, and in the event of encountering an exception do not signal an exception to the processor. This enables implementations to retire following instructions while the non-blocking operation is executing, without the need to retain precise processor state.

Branch prediction

Is where a processor chooses a future execution path to prefetch along (see Prefetching). For example, after a branch instruction, the processor can choose to prefetch either the instruction following the branch or the instruction at the branch target.

Breakpoint

Is a debug event triggered by the execution of a particular instruction, specified in terms of the address of the instruction and/or the state of the processor when the instruction is executed.

Byte

Is an 8-bit data item.

Cache

Is a block of high-speed memory locations whose addresses are changed automatically in response to which memory locations the processor is accessing, and whose purpose is to increase the average speed of a memory access.

Cache contention

Is when the number of frequently-used memory cache lines that use a particular cache set exceeds the set-associativity of the cache. In this case, main memory activity goes up and performance drops.

Cache hit

Is a memory access that can be processed at high speed because the data it addresses is already in the cache.

Cache line

Is the basic unit of storage in a cache. Its size is always a power of two (usually 4 or 8 words), and must be aligned to a suitable memory boundary. A *memory cache line* is a block of memory locations with the same size and alignment as a cache line. Memory cache lines are sometimes loosely just called cache lines.

Cache line index

Is a number associated with each cache line in a cache set. In each cache set, the cache lines are numbered from 0 to (set associativity)-1.

Cache lockdown

Alleviates the delays caused by accessing a cache in a worst-case situation. Cache lockdown enables critical code and data to be loaded into the cache so that the cache lines containing them are not subsequently re-allocated. This ensures that all subsequent accesses to the code and data concerned are cache hits and so complete quickly.

Cache lockdown blocks

Consist of one line from each cache set. Cache lockdown is performed in units of a cache lockdown block.

Cache miss

Is a memory access that cannot be processed at high speed because the data it addresses is not in the cache.

Cache sets

Are areas of a cache, divided up to simplify and speed up the process of determining whether a cache hit occurs. The number of cache sets is always a power of two.

Cache way

A cache way consists of one cache line from each cache set. The cache ways are indexed from 0 to ASSOCIATIVITY-1. The cache lines in a cache way are chosen to have the same index as the cache way. So for example cache way 0 consists of the cache line with index 0 from each cache set, and cache way n consists of the cache line with index n from each cache set.

Callee-save registers

Are registers that a called procedure must preserve. To preserve a callee-save register, the called procedure would normally either not use the register at all, or store the register to the stack during procedure entry and re-load it from the stack during procedure exit.

Caller-save registers

Are registers that a called procedure need not preserve. If the calling procedure requires their values to be preserved, it must store and reload them itself.

Condition field

Is a 4-bit field in an instruction that is used to specify a condition under which the instruction can execute.

Conditional execution

Means that if the condition code flags indicate that the corresponding condition is true when the instruction starts executing, it executes normally. Otherwise, the instruction does nothing.

Configuration

Settings made on reset, or immediately after reset, and normally expected to remain static throughout program execution.

Context switch

Is the saving and restoring of computational state when switching between different threads or processes. In this manual, the term context switch is used to describe any situations where the context is switched by an operating system and might or might not include changes to the address space.

Data cache

Is a separate cache used only for processing data loads and stores.

Digital signal processing (DSP)

Refers to a variety of algorithms that are used to process signals that have been sampled and converted to digital form. Saturated arithmetic is often used in such algorithms.

Direct-mapped cache

Is a one-way set-associative cache. Each cache set consists of a single cache line, so cache look-up just needs to select and check one cache line.

Direct Memory Access

Is an operation that accesses main memory directly, without the processor performing any accesses to the data concerned.

DNM *See* Do-not-modify.

Domain Is a collection of sections, Large pages and Small pages of memory, that can have their access permissions switched rapidly by writing to the Domain Access Control Register, in CP15 c3.

Do-not-modify (DNM)

Means the value must not be altered by software. DNM fields read as UNKNOWN values, and must only be written with the same value read from the same field on the same processor.

Double-precision value

Consists of two 32-bit words that must appear consecutively in memory and must both be word-aligned, and that is interpreted as a basic double-precision floating-point number according to the IEEE 754-1985 standard.

Doubleword

Is a 64-bit data item. Doublewords are normally at least word-aligned in ARM systems.

Doubleword-aligned

Means that the address is divisible by 8.

DSP *See* Digital signal processing

Endianness

Is an aspect of the system memory mapping. See big-endian and little-endian.

Exception

Handles an event. For example, an exception could handle an external interrupt or an Undefined Instruction.

Exception modes

Are privileged modes that are entered when specific exceptions occur.

Exception vector

Is one of a number of fixed addresses in low memory, or in high memory if high vectors are configured.

Execution stream

The stream of instructions that would have been executed by sequential execution of the program.

Explicit access

A read from memory, or a write to memory, generated by a load/store instruction executed in the processor. Reads and writes generated by L1 DMA accesses or hardware translation table accesses are not explicit accesses.

External abort

Is an abort that is generated by the external memory system.

Fault

Is an abort that is generated by the MMU.

Fast Context Switch Extension (FCSE)

Modifies the behavior of an ARM memory system to enable multiple programs running on the ARM processor to use identical address ranges, while ensuring that the addresses they present to the rest of the memory system differ. From ARMv6, use of the FCSE is deprecated, and the FCSE is optional in ARMv7.

FCSE

See Fast Context Switch Extension.

Flat address mapping

Is where the physical address for every access is equal to its virtual address.

Flush-to-zero mode

Is a special processing mode that optimizes the performance of some VFP algorithms by replacing the denormalized operands and intermediate results with zeros, without significantly affecting the accuracy of their final results.

Fully-associative cache

Has just one cache set, that consists of the entire cache. *See also* direct-mapped cache.

General-purpose register

Is one of the 32-bit general-purpose integer registers, R0 to R15. Note that R15 holds the Program Counter, and there are often limitations on its use that do not apply to R0 to R14.

Halfword

Is a 16-bit data item. Halfwords are normally halfword-aligned in ARM systems.

Halfword-aligned

Means that the address is divisible by 2.

High registers

Are ARM core registers 8 to 15, that can be accessed by some Thumb instructions.

High vectors

Are alternative locations for exception vectors. The high vector address range is near the top of the address space, rather than at the bottom.

Immediate and offset fields

Are unsigned unless otherwise stated.

Immediate values

Are values that are encoded directly in the instruction and used as numeric data when the instruction is executed. Many ARM and Thumb instructions permit small numeric values to be encoded as immediate values in the instruction that operates on them.

IMP

Is an abbreviation used in diagrams to indicate that the bit or bits concerned have IMPLEMENTATION DEFINED behavior.

IMPLEMENTATION DEFINED

Means that the behavior is not architecturally defined, but should be defined and documented by individual implementations.

Index register

Is a register specified in some load/store instructions. The value of this register is used as an offset to be added to or subtracted from the base register value to form the virtual address that is sent to memory. Some addressing modes optionally permit the index register value to be shifted before the addition or subtraction.

Inline literals

These are constant addresses and other data items held in the same area as the code itself. They are automatically generated by compilers, and can also appear in assembler code.

Instruction cache

Is a separate cache used only for processing instruction fetches.

Interworking

Is a method of working that permits branches between ARM and Thumb code.

Little-endian memory

Means that:

- a byte or halfword at a word-aligned address is the least significant byte or halfword in the word at that address
- a byte at a halfword-aligned address is the least significant byte in the halfword at that address.

Load/Store architecture

Is an architecture where data-processing operations only operate on register contents, not directly on memory contents.

Long branch

Is the use of a load instruction to branch to anywhere in the 4GB address space.

Memory barrier

See *Memory barriers* on page A3-47.

Memory coherency

Is the problem of ensuring that when a memory location is read (either by a data read or an instruction fetch), the value actually obtained is always the value that was most recently written to the location. This can be difficult when there are multiple possible physical locations, such as main memory, a write buffer and/or cache(s).

Memory Management Unit (MMU)

Provides detailed control of a memory system. Most of the control is provided via translation tables held in memory.

Memory-mapped I/O

Uses special memory addresses that supply I/O functions when they are loaded from or stored to.

Memory Protection Unit (MPU)

Is a hardware unit whose registers provide simple control of a limited number of protection regions in memory.

Mixed-endian

A processor supports mixed-endian memory accesses if accesses to big-endian data and little-endian data can be freely intermixed, with only small performance and code size penalties for doing so.

Modified Virtual Address (MVA)

Is the address produced by the FCSE that is sent to the rest of the memory system to be used in place of the normal virtual address. From ARMv6, use of the FCSE is deprecated, and the FCSE is optional in ARMv7. When the FCSE is absent or disabled the MVA and the *Virtual Address* (VA) have the same value.

MMU See Memory Management Unit.

MPU See Memory Protection Unit.

Multi-copy atomicity

Is the form of atomicity described in *Multi-copy atomicity* on page A3-28.

See also Atomicity, Single-copy atomicity.

MVA See Modified Virtual Address.

NaN NaNs are special floating-point values that can be used when neither a numeric value nor an infinity is appropriate. NaNs can be *quiet* NaNs that propagate through most floating-point operations, or *signaling* NaNs that cause Invalid Operation floating-point exceptions when used. For details, see the IEEE 754 standard.

Observer

A processor or mechanism in the system, such as a peripheral device, that can generate reads from or writes to memory.

Offset addressing

Means that the memory address is formed by adding or subtracting an offset to or from the base register value.

PA See Physical address.

Physical address (PA)

Identifies a main memory location.

Post-indexed addressing

Means that the memory address is the base register value, but an offset is added to or subtracted from the base register value and the result is written back to the base register.

Prefetching

Is the process of fetching instructions from memory before the instructions that precede them have finished executing. Prefetching an instruction does not mean that the instruction has to be executed.

Pre-indexed addressing

Means that the memory address is formed in the same way as for offset addressing, but the memory address is also written back to the base register.

Privileged mode

Is any processor mode other than User mode. Memory systems typically check memory accesses from privileged modes against supervisor access permissions rather than the more restrictive user access permissions. The use of some instructions is also restricted to privileged modes.

Process ID

In the FCSE, this is a 7-bit number that identifies which process block the current process is loaded into.

Protection region

Is a memory region whose position, size, and other properties are defined by Memory Protection Unit registers.

Protection Unit

See Memory Protection Unit.

Pseudo-instruction

UAL assembler syntax that assembles to an instruction encoding that is expected to disassemble to a different assembler syntax, and is described in this manual under that other syntax. For example, `MOV <Rd>, <Rm>, LSL #<n>` is a pseudo-instruction that is expected to disassemble as `LSL <Rd>, <Rm>, #<n>`

Quiet NaN

Is a NaN that propagates unchanged through most floating-point operations.

RAO

See Read-As-One.

RAZ

See Read-As-Zero.

RAO/SBOP

Read-As-One, Should-Be-One-or-Preserved on writes.

In any implementation, the bit must read as 1, or all 1s for a bit field, and writes to the field must be ignored.

Software can rely on the bit reading as 1, or all 1s for a bit field, but must use an SBOP policy to write to the field.

RAO/WI

Read-As-One, Writes Ignored.

In any implementation, the bit must read as 1, or all 1s for a bit field, and writes to the field must be ignored

Software can rely on the bit reading as 1, or all 1s for a bit field, and on writes being ignored.

RAZ/SBZP

Read-As-Zero, Should-Be-Zero-or-Preserved on writes.

In any implementation, the bit must read as 0, or all 0s for a bit field, and writes to the field must be ignored.

Software can rely on the bit reading as 0, or all 0s for a bit field, but must use an SBZP policy to write to the field.

RAZ/WI Read-As-Zero, Writes Ignored.

In any implementation, the bit must read as 0, or all 0s for a bit field, and writes to the field must be ignored.

Software can rely on the bit reading as 0, or all 0s for a bit field, and on writes being ignored.

Read-allocate cache

Is a cache in which a cache miss on reading data causes a cache line to be allocated into the cache.

Read-As-One (RAO)

In any implementation, the bit must read as 1, or all 1s for a bit field.

Read-As-Zero (RAZ)

In any implementation, the bit must read as 0, or all 0s for a bit field.

Read, modify, write

In a read, modify, write instruction sequence, a value is read to a general-purpose register, the relevant fields updated in that register, and the new value written back.

Reserved

Unless otherwise stated:

- instructions that are reserved or that access reserved registers have UNPREDICTABLE behavior
- bit positions described as Reserved are UNK/SBZP.

RISC Reduced Instruction Set Computer.**Rounding error**

Is defined to be the value of the rounded result of an arithmetic operation minus the exact result of the operation.

Rounding modes

Specify how the exact result of a floating-point operation is rounded to a value that is representable in the destination format.

Round to Nearest (RN) mode

Means that the rounded result is the nearest representable number to the unrounded result.

Round towards Plus Infinity (RP) mode

Means that the rounded result is the nearest representable number that is greater than or equal to the exact result.

Round towards Minus Infinity (RM) mode

Means that the rounded result is the nearest representable number that is less than or equal to the exact result.

Round towards Zero (RZ) mode

Means that results are rounded to the nearest representable number that is no greater in magnitude than the unrounded result.

Saturated arithmetic

Is integer arithmetic in which a result that would be greater than the largest representable number is set to the largest representable number, and a result that would be less than the smallest representable number is set to the smallest representable number. Signed saturated arithmetic is often used in DSP algorithms. It contrasts with the normal signed integer arithmetic used in ARM processors, in which overflowing results wrap around from $+2^{31}-1$ to -2^{31} or vice versa.

SBO *See* Should-Be-One.

SBOP *See* Should-Be-One-or-Preserved.

SBZ *See* Should-Be-Zero.

SBZP *See* Should-Be-Zero-or-Preserved.

Security hole

Is a mechanism that bypasses system protection.

Self-modifying code

Is code that writes one or more instructions to memory and then executes them. When using self-modifying code you must use cache maintenance and barrier instructions to ensure synchronization. For details see *Ordering of cache and branch predictor maintenance operations* on page B2-21.

Set-associativity

Is the number of cache lines in each of the cache sets in a cache. It can be any number ≥ 1 , and is not restricted to being a power of two.

Should-Be-One (SBO)

Should be written as 1, or all 1s for a bit field, by software. Values other than 1 produce UNPREDICTABLE results.

Should-Be-One-or-Preserved (SBOP)

Must be written as 1, or all 1s for a bit field, by software if the value is being written without having been previously read, or if the register has not been initialized. Where the register was previously read on the same processor, since the processor was last reset, the value in the field should be preserved by writing the value that was previously read.

Hardware must ignore writes to these fields.

If a value is written to the field that is neither 1 (or all 1s for a bit field), nor a value previously read for the same field on the same processor, the result is UNPREDICTABLE.

Should-Be-Zero (SBZ)

Should be written as 0, or all 0s for a bit field, by software. Values other than 0 produce UNPREDICTABLE results.

Should-Be-Zero-or-Preserved (SBZP)

Must be written as 0, or all 0s for a bit field, by software if the value is being written without having been previously read, or if the register has not been initialized. Where the register was previously read on the same processor, since the processor was last reset, the value in the field should be preserved by writing the value that was previously read.

Hardware must ignore writes to these fields.

If a value is written to the field that is neither 0 (or all 0s for a bit field), nor a value previously read for the same field on the same processor, the result is UNPREDICTABLE.

Signaling NaNs

Cause an Invalid Operation exception whenever any floating-point operation receives a signaling NaN as an operand. Signaling Nans can be used in debugging, to track down some uses of uninitialized variables.

Signed data types

Represent an integer in the range -2^{N-1} to $+2^{N-1} - 1$, using two's complement format.

Signed immediate and offset fields

Are encoded in two's complement notation unless otherwise stated.

SIMD Means Single-Instruction, Multiple-Data operations.

Single-copy atomicity

Is the form of atomicity described in *Single-copy atomicity* on page A3-27.

See also Atomicity, Multi-copy atomicity.

Single-precision value

Is a 32-bit word, that must be word-aligned when held in memory, and that is interpreted as a basic single-precision floating-point number according to the IEEE 754-1985 standard.

Spatial locality

Is the observed effect that after a program has accessed a memory location, it is likely to also access nearby memory locations in the near future. Caches with multi-word cache lines exploit this effect to improve performance.

SUBARCHITECTURE DEFINED

Means that the behavior is expected to be specified by a subarchitecture definition. Typically, this will be shared by multiple implementations, but it must only be relied on by specified types of code. This minimizes the software changes required when a new subarchitecture has to be developed.

In this manual, subarchitecture definitions are used for:

- the interface between a VFP implementation and its support code
- the interface between an implementation of the Jazelle extension and an Enabled JVM.

Tag bits ~~Are bits $[31:L+S]$ of a virtual address, where $L = \log_2(\text{cache line length})$ and $S = \log_2(\text{number of cache sets})$. A cache hit occurs if the tag bits of the virtual address supplied by the ARM processor match the tag bits associated with a valid line in the selected cache set.~~

Temporal locality

Is the observed effect that after a program has accesses a memory location, it is likely to access the same memory location again in the near future. Caches exploit this effect to improve performance.

Thumb instruction

Is one or two halfwords that specify an operation for a processor in Thumb state to perform. Thumb instructions must be halfword-aligned.

TLB *See* Translation Lookaside Buffer.

TLB lockdown

Is a way to prevent specific translation table walk results being accessed. This ensures that accesses to the associated memory areas never cause a translation table walk.

Translation Lookaside Buffer (TLB)

Is a memory structure containing the results of translation table walks. They help to reduce the average cost of a memory access. Usually, there is a TLB for each memory interface of the ARM implementation.

Translation tables

Are tables held in memory. They define the properties of memory areas of various sizes from 1KB to 1MB.

Translation table walk

Is the process of doing a full translation table lookup. It is performed automatically by hardware.

Trap enable bits

Determine whether trapped or untrapped exception handling is selected. If trapped exception handling is selected, the way it is carried out is IMPLEMENTATION DEFINED.

Unaligned

An unaligned access is an access where the address of the access is not aligned to the size of an element of the access.

Unaligned memory accesses

Are memory accesses that are not, or might not be, appropriately halfword-aligned, word-aligned, or doubleword-aligned.

Unallocated

Except where otherwise stated, an instruction encoding is unallocated if the architecture does not assign a specific function to the entire bit pattern of the instruction, but instead describes it as UNDEFINED, UNPREDICTABLE, or an unallocated hint instruction.

A bit in a register is unallocated if the architecture does not assign a function to that bit.

UNDEFINED

Indicates an instruction that generates an Undefined Instruction exception.

See also Undefined Instruction exception on page B1-49.

Unified cache

Is a cache used for both processing instruction fetches and processing data loads and stores.

Unindexed addressing

Means addressing in which the base register value is used directly as the virtual address to send to memory, without adding or subtracting an offset. In most types of load/store instruction, unindexed addressing is performed by using offset addressing with an immediate offset of 0. The LDC, LDC2, STC, and STC2 instructions have an explicit unindexed addressing mode that permits the offset field in the instruction to be used to specify additional coprocessor options.

UNKNOWN

An UNKNOWN value does not contain valid data, and can vary from moment to moment, instruction to instruction, and implementation to implementation. An UNKNOWN value must not be a security hole. UNKNOWN values must not be documented or promoted as having a defined value or effect.

UNK/SBOP

UNKNOWN on reads, Should-Be-One-or-Preserved on writes.

In any implementation, the bit must read as 1, or all 1s for a bit field, and writes to the field must be ignored.

Software must not rely on the bit reading as 1, or all 1s for a bit field, and must use an SBOP policy to write to the field.

UNK/SBZP

UNKNOWN on reads, Should-Be-Zero-or-Preserved on writes.

In any implementation, the bit must read as 0, or all 0s for a bit field, and writes to the field must be ignored.

Software must not rely on the bit reading as 0, or all 0s for a bit field, and must use an SBZP policy to write to the field.

UNK

Is an abbreviation indicating that software must treat a field as containing an UNKNOWN value.

In any implementation, the bit must read as 0, or all 0s for a bit field. Software must not rely on the field reading as zero.

UNPREDICTABLE

Means the behavior cannot be relied upon. UNPREDICTABLE behavior must not represent security holes. UNPREDICTABLE behavior must not halt or hang the processor, or any parts of the system. UNPREDICTABLE behavior must not be documented or promoted as having a defined effect.

Unsigned data types

Represent a non-negative integer in the range 0 to $+2^N-1$, using normal binary format.

VA

See Virtual address.

VFP

Is a coprocessor extension to the ARM architecture. It provides single-precision and double-precision floating-point arithmetic.

Virtual address (VA)

Is an address generated by an ARM processor. For a PMSA implementation, the virtual address is identical to the physical address.

Watchpoint

Is a debug event triggered by an access to memory, specified in terms of the address of the location in memory being accessed.

Word Is a 32-bit data item. Words are normally word-aligned in ARM systems.

Word-aligned

Means that the address is divisible by 4.

Write-Allocate cache

Is a cache in which a cache miss on storing data causes a cache line to be allocated into the cache.

Write-Back cache

Is a cache in which when a cache hit occurs on a store access, the data is only written to the cache. Data in the cache can therefore be more up-to-date than data in main memory. Any such data is written back to main memory when the cache line is cleaned or re-allocated. Another common term for a Write-Back cache is a *copy-back cache*.

Write-Through cache

Is a cache in which when a cache hit occurs on a store access, the data is written both to the cache and to main memory. This is normally done via a write buffer, to avoid slowing down the processor.

Write buffer

Is a block of high-speed memory whose purpose is to optimize stores to main memory.